

OPERATING INSTRUCTIONS

Bun Toaster Grill Model No. 212-G, 212-GF 212-GFC, 212-GFCE, 212-GFCCE



TABLE OF CONTENTS	PAGE
Installation.....	2
Operating.....	2
Cleaning.....	3
Electrical Repairs.....	4
Troubleshooting.....	7
Parts List.....	8
Exploded View.....	9
Wiring and Electrical Information.....	10

SPECIFICATIONS

212-G/GC	Dimensions
Width	16' (40.6 cm)
Depth	26' (66.0 cm)
Height	11 1/2" (29.2 cm)
Shipping Weight	70 lbs. (31.7 kg.)

ELECTRICAL

212-G	212-GH	212-GF, 212-GFC	212-GFCE 212-GFCCE
110/120V 60 Hz	110/120V 60 Hz	220V 50 Hz	220V 50 Hz

*All units are single phase with grounded outlet.

LIMITED WARRANTY

This product is warranted to be free from defects in material and/or workmanship for a period of 1 year from date of original installation, not to exceed 18 months from the date of manufacture.

Any component which proves to be faulty in material and/or workmanship will be replaced or repaired (at the option of Prince Castle, Inc.) without cost to the customer for parts and labor. This equipment is portable; charges for on-location service (e.g., trip charges, mileage) are not included in the provisions of this warranty.

This warranty is subject to the following exceptions/conditions:

- Use of any non-genuine Prince Castle parts voids this warranty.
- All labor to be performed during regular work hours. Overtime premium (the incremental amount) will be charged to the customer.
- Damage caused by carelessness, neglect and/or abuse (e.g., dropping, tampering or altering parts, equipment damaged in shipment, by fire, flood or an act of God) is not covered under this warranty.
- All problems due to operation at voltages other than that specified on equipment nameplates are not covered by this warranty. Conversion to correct voltage is the customer's responsibility.
- This equipment must be serviced by Prince Castle Authorized Service Agency or a Prince Castle Service Technician during the warranty period.



INSTALLATION

1. After you have removed the toaster from the carton, inspect the unit for signs of damage. If there is damage to the unit:

- Notify carrier within 24 hours after delivery.
- Save carton and packaging materials for inspection purposes.
- Contact Prince Castle Customer Sales Department at 1-800-323-2930 to arrange for a replacement to be sent.

2. Verify that all parts have been received.

3. Insert the power cord into proper receptacle.

IMPORTANT: Improper electrical installation causing damage to parts of this toaster will void the warranty. Make sure toaster plug is compatible with outlet before inserting. Outlet must be wired to match plug. Refer to wiring diagram on page 10.

4. Flip on/off switch to ON position. The “power on” light and “thermostat cycle” light will come on. Allow 30 minutes for the heating platen to reach to proper temperature.

OPERATION

1. Using a bun spatula or optional bun tray, place 12 cut crowns face up.

2. Place 12 heels on spatula face down.

3. Lift bun board and insert spatula with heels. See Figure 1.

figure 1



4. Lower bun board on spatula and slide spatula out. See Figure 2.

figure 2



5. Insert spatula (or bun tray), with crowns, into lower compartments of the toasters. See Figure 3.

figure 3



6. Pull handle forward to move heating platen on top of crowns. Timer is automatically activated. See Figure 4.

figure 4



- When buzzer sounds and the done light comes on, immediately push handle back to release crowns from heating platen. Remove spatula from toaster. See Figure 5.



figure 5

- Lift bun board and slide spatula in under the heels and remove.

CLEANING

- Unplug toaster and allow it to cool down.
- Shake a small amount of cleanser on platen.
- Dampen toaster platen cleaning pad and wipe off top and bottom of platen.

IMPORTANT: Using a cleaning pad other than the one provided may be too abrasive and take off the nickel plating, causing buns to stick. Replacement pads should be purchased from your local Prince Castle Service Center. Order part # 167-2.

CAUTION: Do not pour water on the platen. This may cause an electrical hazard and damage switches, linkage, etc., voiding the warranty.

- Starting from the center, proceed to clean platen by wiping in a front to back motion with grain of platen.
- Using a moist cloth, wipe off platen to remove all cleaning materials.

ADJUSTMENTS

TIMER

- The timer is preset at the factory for 55 seconds. If for any reason the time has to be changed, remove the plug button from the rear of the toaster. A

small adjusting screw will be exposed. Using a small screwdriver and a stop watch or clock with a second hand, turn the screw clockwise to increase the time, or counterclockwise to decrease the time. After adjusting the screw, check the timing with the stop watch or the clock with the second hand. Replace the plug button when finished. See below.

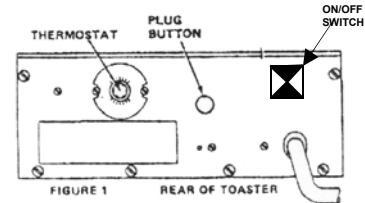

THERMOSTAT

- The thermostat is set by the factory at 204°C. If for any reason temperature has to be changed, there is an adjustment located on the rear of the toaster. Turn the knob clockwise to raise the temperature or counterclockwise to lower the temperature.

PLATEN HEIGHT

- To set height of platen, turn either right or left stop block located on the side of the toaster to desired number – number 1 being the lowest setting for thin buns and number 5 being the highest setting for thick buns.

GENERAL INSTRUCTIONS

When disconnecting electrical wires, mark them in some way that will indicate which terminal they came from. Do not disconnect too many electrical connections at one time. Refer to the individual wiring diagrams for particular controls that need repair.

There are 3 basic methods of affixing wires to their terminals:

- Closed eye
- Spade
- Knife and blade

IMPORTANT: Do not wrap a bare wire under a terminal head screw.

- Disconnect electrical supply.
- Permit the unit to cool completely.

IMPORTANT: Make good use of the parts pictures in this chapter for further aid in understanding the physical makeup of your toaster and the reassembling of its components.

ELECTRICAL REPAIRS

CAUTION: Before any electrical repairs, place power switch in OFF position and unplug toaster.

When replacing any electrical controls mounted in control boxes, disassemble the following.

1. Remove (2) screws from upper or lower cover.
2. Remove cover(s).
3. Remove (5) screws from upper or lower faceplate.

REPLACE PLATEN

CAUTION: This procedure should be done by a qualified service person.

REPLACE LIGHTS (See figure 7.)

figure 7

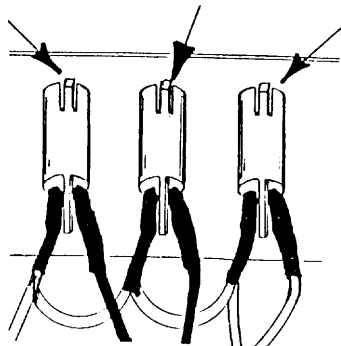

1. Locate inoperable light.
2. Disconnect (2) wires from the light.
3. Remove the light by pressing the bezel clips in and pulling the light away from the control panel.
4. Reverse procedure to install new light.

REPLACE POWER SWITCH (See figure 8.)

1. Remove nut holding switch and switch plate to faceplate.
2. Remove switch.
3. Remove wires from switch.
4. Replace by reversing procedure.

figure 8

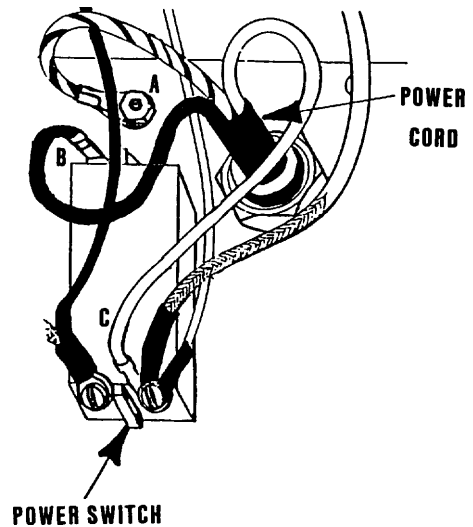

REPLACE POWER CORD (See figure .8)

Tools Required • Flatblade screwdriver

CAUTION: This procedure should be done by a qualified service person.

1. The power switch will have to be removed to get at the (2) heavy power cord wires connected to the bottom terminals. See figure .
2. Disconnect green/yellow ground wire from the power switch.
3. For Model 212-G/212-GF disconnect brown wire from the power switch (B). For Model 212-GH disconnect brown and black wires from the power switch.
4. Disconnect blue neutral wire from power switch (C). (For model 212-G/GF only).
5. Remove power cord from lower chassis by removing strain relief.
6. Reverse procedure to reinstall power cord.

REPLACE BUZZER (See figure 9.)

figure 9

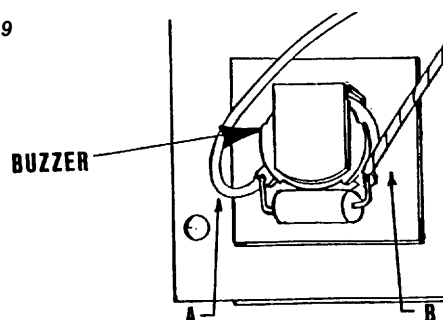

Tools Required • Flatblade screwdriver

1. Remove screw holding buzzer to faceplate.
2. Cut wires A and B and strip wires 1/4'.
3. Replace inoperable buzzer.
4. Connect new buzzer with wire nuts provided.

CAUTION: Make sure no strands of wire are exposed. This may cause a short.

IMPORTANT: 212-DH has two "B" wires (both white) that are to be cut, stripped and attached to the single "B" wire on buzzer with wire nuts provided.

REPLACE THERMOSTAT (See figure 10.)

figure 10

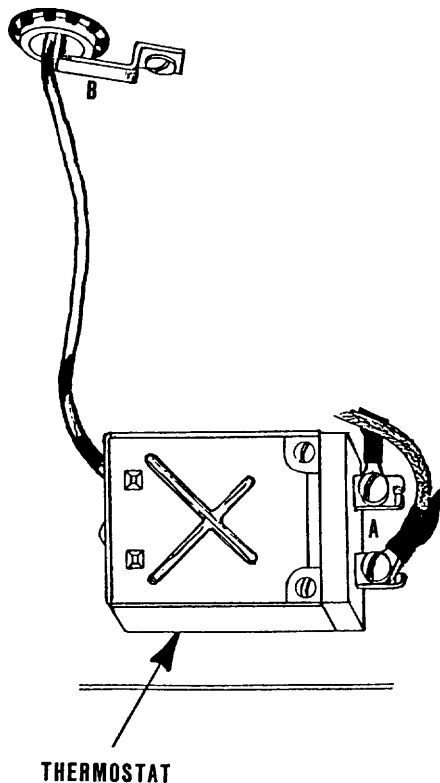

Tools Required • Flatblade screwdriver

1. Remove knob by loosening small set screw in knob.
2. Remove (2) screws that hold thermostat to rear cover.
3. Remove (2) wires from thermostat terminals.
4. Remove thermostat bulb retainer from electrical box.
5. Remove thermostat and sensing bulb.

IMPORTANT: Replace with new thermostat by revers-

ing procedure. Make sure to coat new thermostat bulb with thermo-coat provided.

HOW TO CALIBRATE TEMPERATURES

Tools Required • Flatblade screwdriver
• Digital thermometer with surface probe
• Stopwatch

1. Plug toaster in and turn the power switch to ON. Allow 45 minutes for the platen temperature to stabilize.
2. Place the surface probe of the digital thermometer in the center of the top platen.

IMPORTANT: The temperature should be at 204° C +/- 6° C when the temperature light goes off.

3. Repeat step 2 by placing the surface probe in the lower platen.

CAUTION: Toaster must be hot to check temperature calibration. Special care must be taken to prevent being burned.

If the temperature is not within the range:

4. Turn the outer temperature shaft in the rear of the toaster. (Turn shaft clockwise to increase and counterclockwise to decrease platen temperature.)

IMPORTANT: A 1/4 turn will change the temperature approximately 70° F (47° C).

5. Allow 20 minutes for the platen temperature to stabilize before readjusting.
6. Adjust the thermostat dial plate so the correct temperature is in line with the pointer on the thermostat knob.

REPLACE TIMER SWITCH (See figures 11 & 12)

Tools Required • Adjustable wrench

1. Unscrew retaining nut on outside of electrical box.
2. Remove switch from electrical box.
3. Remove retaining ring and insulator from switch.
4. Remove (2) wires from timer switch.
5. Mount (2) wires on new switch.
6. Insert new switch into insulator.

- Position retaining ring on new switch $1/4$ " (6 mm) from end of bushing. See figure 11.

figure 11

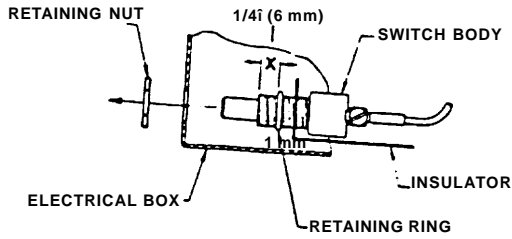

CAUTION: Be sure insulator is between switch body and retaining ring.

- Install new switch into electrical box and tighten retaining nut on outside of electrical box.
- Set stop blocks at lowest position.
- Lower platen slowly and watch movement of new switch against actuator bracket.

IMPORTANT: When platen is all the way down, there should be no more than $1/32$ " (1 mm) clearance between threaded switch bushing and actuator bracket.

IMPORTANT: The threaded switch bushing must not press against the actuator bracket.

- To adjust actuator bracket, loosen mounting screws and move bracket until $1/32$ " (1 mm) clearance is attained as shown in drawing below. Retighten actuator bracket mounting screws when bracket is positioned. See figure 12.

figure 12

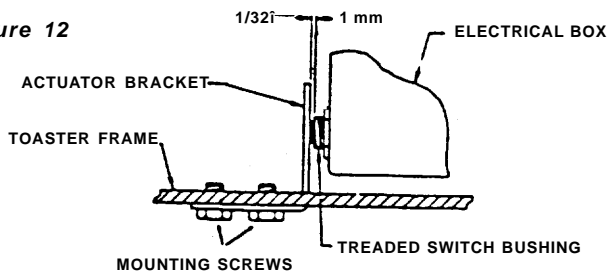

- Tighten retaining nut against chassis to prevent movement.

REPLACE TIMER (See figure 13.)

figure 13

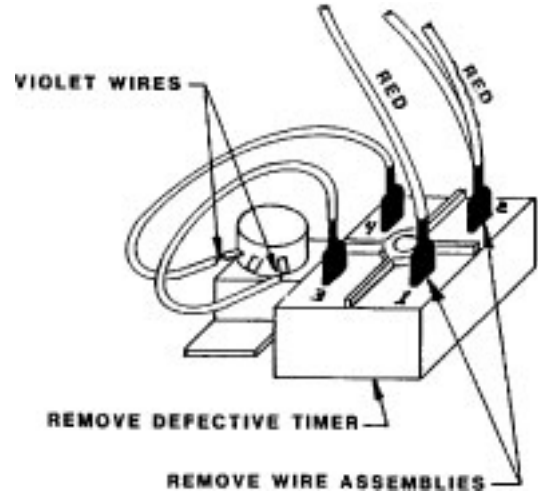

- Remove (4) wires from timer.
- Remove screw and nut holding timer to faceplate.
- Remove timer.
- Replace with new timer by reverse procedure.

TROUBLESHOOTING CHART

Problem	Cause	Solution
1. Power Light Off.	<p>Circuit Breaker Off.</p> <p>Unit Not Plugged In.</p> <p>Power Switch Off.</p> <p>Inoperable Power Switch.</p> <p>Loose Wires.</p> <p>Inoperable Power Light.</p>	<p>Check and Reset.</p> <p>Plug In Cord.</p> <p>Turn To On Position.</p> <p>Replace Power Switch.</p> <p>Check All Wire Connections.</p> <p>Replace Power Light.</p>
2. No Heat.	<p>Circuit Breaker Off.</p> <p>Unit Not Plugged In.</p> <p>Power Switch Off.</p> <p>Inoperable Thermostat.</p> <p>Inoperable Platen.</p>	<p>Check and Reset.</p> <p>Plug in Cord.</p> <p>Turn To On Position.</p> <p>Place Both Thermostat Wires on Same Terminal. If Platen Heats Replace Thermostat.</p> <p>Take An Ohm Reading Across the Two Platen Calrods and verify 11 Ohms. If Not Replace Platen.</p>
3. No Audible Or Visual Alarm.	<p>Inoperable Activating Switch.</p> <p>Inoperable Timer.</p>	<p>Replace Activating Switch.</p> <p>Replace Timer.</p>
4. No Audible Alarm.	<p>Inoperable Buzzer.</p>	<p>Replace Buzzer.</p>
5. Buns Toasting Too Light.	<p>Platen Temperature Too Low.</p> <p>Not Enough Bun Compression.</p>	<p>Verify Platen Temperature and Adjust Potentiometer To Proper Temperature.</p> <p>Adjust Stop Blocks Until You Recieve Proper Compression</p>
6. Buns Toasting Too Dark.	<p>Platen Temperature Too High.</p> <p>Inoperable Thermostat.</p> <p>Inoperable Timer.</p>	<p>Verify Platen Temperature and Adjust Potentiometer To Proper Temperature.</p> <p>If Platen Temperature Can Not Be Adjusted Replace The Thermostat.</p> <p>Check Timer and Verify The Countdown Time, If Wrong Adjust Timer To The Right Setting, Or Replace The Timer.</p>
7. Buns Sticking.	<p>Platen Temperature Too High.</p> <p>Too Much Compression.</p> <p>Dirty Platen.</p>	<p>Verify Platen Temperature and Adjust Potentiometer.</p> <p>Check Stop Blocks and Adjust To Correct Setting.</p> <p>When Cool Remove Excess Carmelization With A Damp Cloth and A Non-Abrasive Cleaner.</p>

PARTS LIST

ITEM	PART NO.	DESCRIPTION	ITEM	PART NO.	DESCRIPTION
2	416-29	Cam Rod	47	71-136-1	Pilot Light, Amber (212-GF, 212-GFC,212-GFCE,212-GFCCE, 212-GJ)
4	79-105	Spacer	48	71-135-3S	Pilot Light, Green (212-G) (115V)
5	81-011	Compression Ring		71-136-3S	Pilot Light, Green (212-GH, 212-GF, 212-GFC, 212-GFCE, 212-GFCCE, 212-GJ)
6	416-27	Cam Stop	49	71-135-2S	Pilot Light, White (212-G) (115V)
7	76-343	Set Screw		71-134-2S	Pilot Light, White (212-GH, 212-GF, 212-GFC,212GFCE, 212-GFCCE, 212-GJ)
8	212-226	Back Stop	50	78-166S	ON/OFF Switch
9	212-21	Spacer	52	212-351	Buzzer (212-G) (115V)
11	919-18	Feet (set of 4)		212-352	Buzzer (212-GH, 212-GF, 212-GFC, 212-GFCE, 212-GFCEC, 212-GJ)
12	212-360	Actuator Bracket	53	212-419	Bun Spatula
14	62-005	Bearing (with levers)	54	212-240	Buzzer Insulator
15	62-021	Bearing (with levers)	55	88-411	Timer (212-G, 212-GH)
16	212-22	Bearing Stud (Pkg. of 2)		88-413	Timer (212-GF, 212-GFC, 212-GFCE, 212-GFCCE)
17	416-65	Nut, Platen Retaining	56	66-045S	Strain Relief, Aluminum
19	212-229	Left Lever Assy.	56A	920-184	Locknut (for 66-031)
20	212-230	Right Lever Assy.	57	72-121S	Power Cord (212-G, 212-GC, 212-GF, 212-GFC, 212-GFCE, 212-GFCCE)
21	212-168	Handle Assy.		72-117S	Power Cord w/plug (212-G, 212-GJ)
25	212-327S	Potentiometer Assy.		72-134S	Power Cord (212-GH)
26	88-143	Plug Button		72-131S	Power Cord w/plug (212-GH)
32	213-83	Platen (212-G) (115V)	58	88-106	Plug (212-G, 212-GJ)
	213-84	Platen (212-GH, 212-GF, 212-GFCE, 212-GFCCE) (220V)		88-165	Plug (212-GH)
	213-85	Platen (212-GJ, 212-GJNS) (200 V)	59	66-037	Strain Relief, Cord Grip Bracket
34	212-290	Bun Board Assy. 1/2" Height (212-G, 212-GH, 212-GJ, 212-GF, 212-GFC, 212-GFCE, 212-GFCCE)			
37	212-220	Cover			
39	213-364	Tube For Platen			
40	213-245	Retaining Ring (Pkg. of 12)			
42	222-122A	Thermostat Kit (Items 43 & 44)			
43	222-91	Dial Plate Thermostat			
44	222-102S	Knob, Thermostat			
45	78-146S	Timer Switch			
46	416-43	Insulation Switch (212-G, 212-GS, 212-GH, 212-GF, 212-GFC, 212-GFCE, 212-GFCCE)			
47	71-135-1	Pilot Light, Amber (212-G, 212-GH) (115V)			

EXPLODED VIEW

