

**SOLID STATE DIGITAL TOASTER
PRINCE CASTLE MODEL NO. 411-CFMCE SERIES**

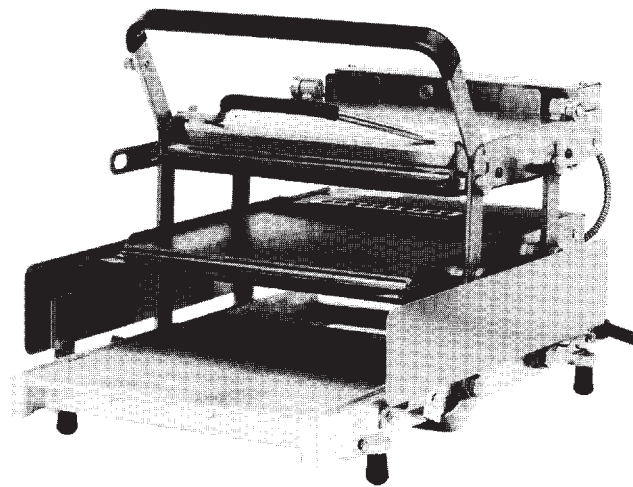

This equipment chapter is to be placed in the toasters section of your *Equipment Manual*.

**MANUFACTURED FOR
MCDONALD'S®
BY
PRINCE CASTLE INC.
355 KEHOE BLVD.
CAROL STREAM, IL. 60188 USA
PHONE 1-630-462-8800
TOLL FREE NUMBER
1-800-323-2930
FAX:1-630-462-1460**



WARRANTY	Page 1
SIDE VIEW	Page 2
FRONT VIEW	Page 3
REAR VIEW	Page 3
INTERNAL VIEW	Page 4
EQUIPMENT SET-UP	Page 5
PROGRAMMING	Page 6
CLEANING	Page 8
TROUBLESHOOTING	Page 8
DIAGNOSTIC TROUBLESHOOTING	Page 9-10
TRANSLATIONS (FRENCH, GERMAN, SPANISH, ITALIAN)	Page 11-34
WIRING DIAGRAM	Page 35

LIMITED WARRANTY

This product is warranted to be free from defects in material and/or workmanship for a period of (2) years from date of original installation not to exceed 30 months from date of shipment from our factory. Printed circuit boards and platen are warranted for a period of (3) years from date of original installation not to exceed 42 months from date of shipment from our factory. Any part or component which proves to be faulty in material and/or workmanship within the warranty period will be replaced or repaired without cost to the customer for parts or labor. (At the option of Prince Castle, Inc.)

This warranty is subject to the following exceptions/conditions:

- Any use of Non-genuine Prince Castle spare parts voids this warranty, and all work must be performed by an authorized Prince Castle Service Agent.
- All labor should be performed during regular working hours. Overtime premium will not be covered.
- Travel charges are limited to 100 miles (200 km) round trip, 2 hours travel time, one trip per repair.
- Damage caused by carelessness, neglect, and/or abuse (e.g., using wrong current, dropping, tampering with or altering electrical components, or improper cleaning) is not covered.
- Equipment damaged in shipment, by fire, flood or an act of God.

This manual is for the exclusive use of licensees and employees of McDonald's Systems, Inc.

Printed in October

Part No. 411-536

SIDE VIEW

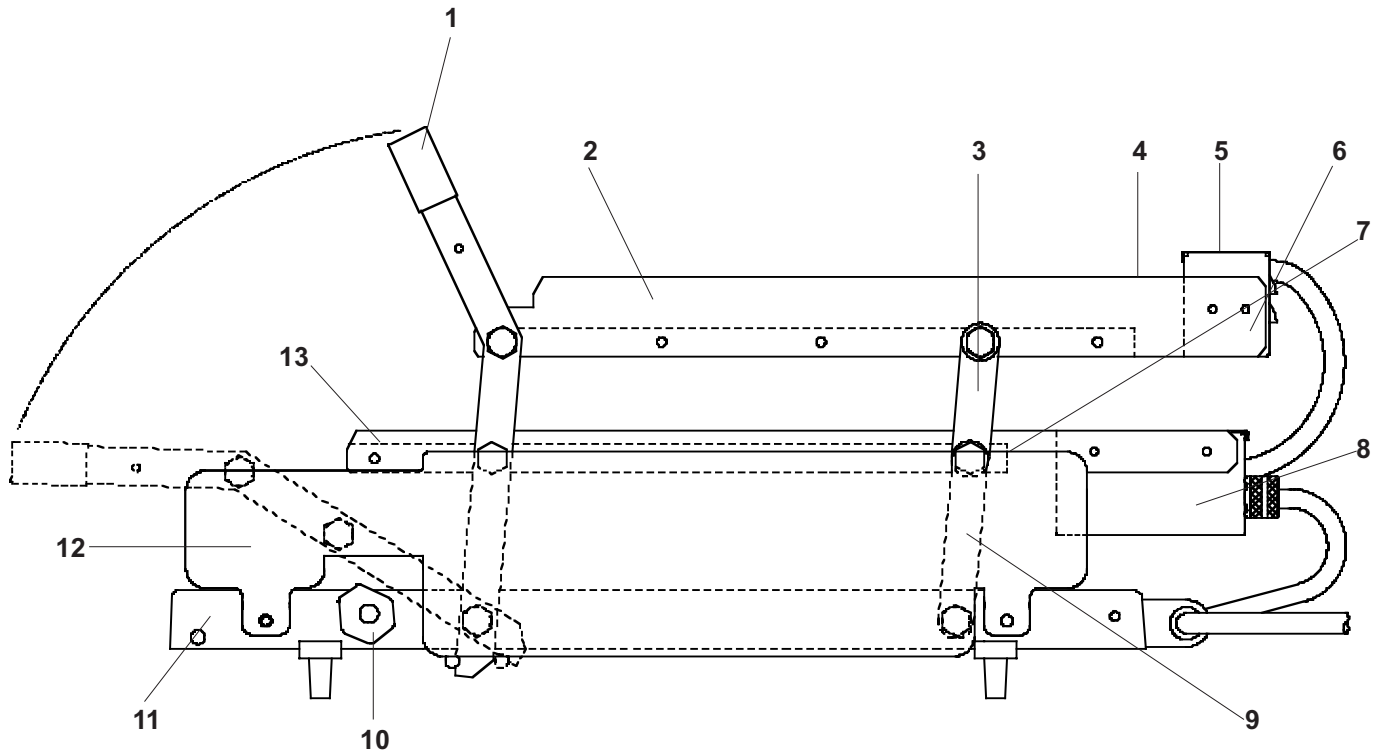

PARTS LIST

ITEM	PART NUMBER	DESCRIPTION
1	411-149S	Handle and Lever Assy.
2	411-441	Right Hand Upper Bun Fence
	411-440	Left Hand Upper Bun Fence
3	411-161S	Upper Rear Lever Assy.
4	411-378	Upper Rear Bun Fence
5	411-31	Upper Cover
6	411-283	Upper Chassis
7	411-381	Lower Rear Bun Fence
8	411-741	Lower Chassis
9	411-459S	Lower Rear Lever Assy.
10	411-137	Right Hand Stop Block
	411-138	Left Hand Stop Block
11	411-2S	Base
12	411-444	Side Panel, Right Hand
	411-445	Side Panel, Left Hand
13	411-379	Right Hand Lower Bun Fence
	411-380	Left Hand Lower Bun Fence
Not Shown	411-114	Safety Latch
Not Shown	411-131	Bun Board

FRONT VIEW

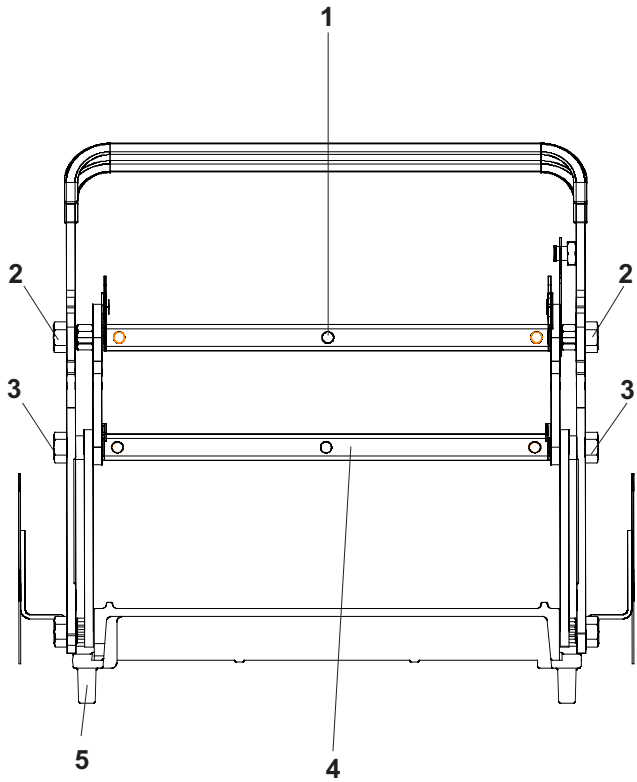

PARTS LIST

ITEM	PART NUMBER	DESCRIPTION
1	411-483S	Upper Platen 230V
2	411-60	Front Upper Platen Stud
3	411-60	Front Lower Platen Stud
4	411-486S	Lower Platen 230V
5	89-959S	Foot (Pkg. of 4)

REAR VIEW

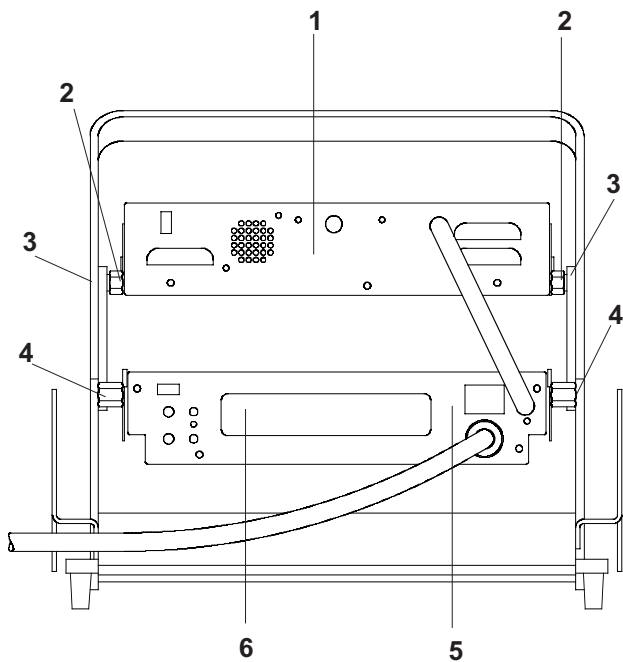

PARTS LIST

ITEM	PART NUMBER	DESCRIPTION
1	411-712	Upper Faceplate
2	411-57	Platen Spacer
3	411-147	Rear Upper Platen Stud
4	411-61	Rear Lower Platen Stud
5	411-705	Lower Faceplate
6	411-707	Overlay

INTERNAL VIEW UPPER CONTROL BOX

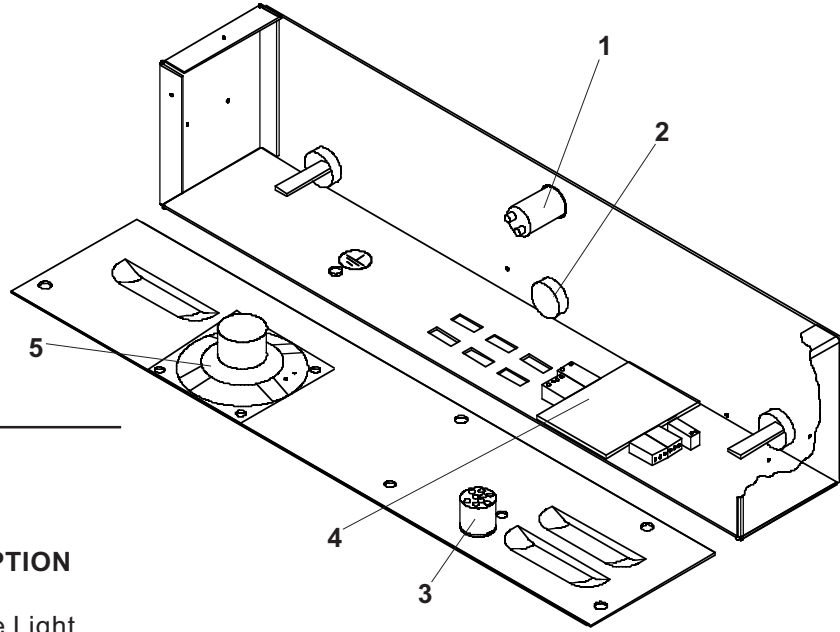

PARTS LIST

ITEM	PART NUMBER	DESCRIPTION
1	213-257S	Bun Done Light
2	411-700S	Upper Probe
3	411-740	Interconnect Cable
4	411-14S	Interconnect Board
5	213-229S	Speaker

INTERNAL VIEW LOWER CONTROL BOX

PARTS LIST

ITEM	PART NUMBER	DESCRIPTION
1	65-053-04S	Relay
2	411-700S	Probe
4	72-301S	Power Cord
5	78-166S	Rocker Switch
6	411-427-02S	Control Display P.C. Board, 200-230V

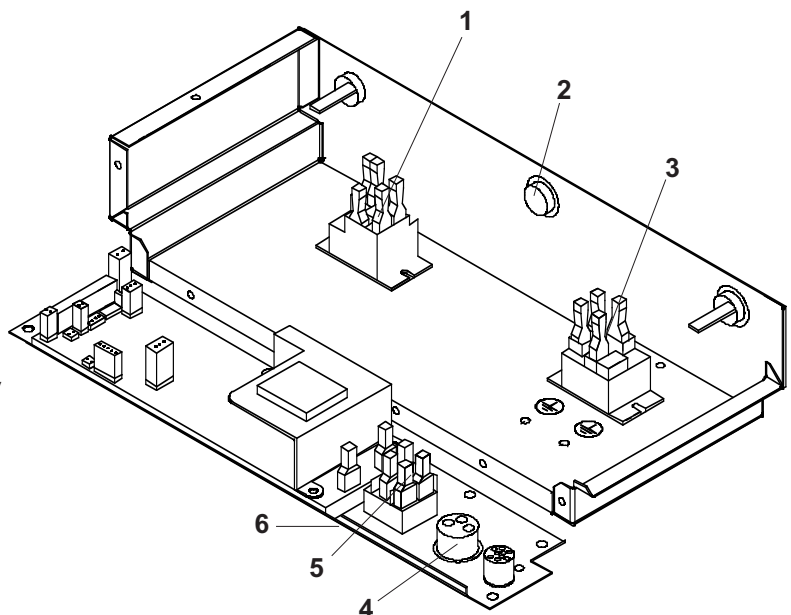

SYMBOLS & TERMS

C -- A Toaster is set on Celsius.

F -- A Toaster is set on Fahrenheit.

A L - Alarm Level setting 1-4.



Sound Button: Used with timer button and temperature button to set alarm level.



Timer Button: Used to view time in run mode. Used to set time in program mode.



Temperature Button: Used to view set point temperature in run mode, and used to set the set point temperature in program mode.



Up Arrow: Used to set time, sound and temperature in program mode.



Down Arrow: Used to set time, sound, and temperature in program mode.

FACTORY PRE-SET

Prince Castle's Solid State Digital Display toasters are pre-set at the factory.

If your toaster model is set for a 35 second toast time, then the temperature is pre-set and calibrated to 215°C.

If your toaster model is set for a 55 second toast time, then the temperature is pre-set and calibrated to 204°C.

SET-UP

1. Refer to the nameplate on the control box for the proper operating voltage. Connect the toaster to a grounded receptacle that matches the nameplate voltage information. Press the power switch to the on position, allow the unit 30 minutes to reach operating temperature.
2. The toaster is factory-set to display temperatures reading in Celsius. When the toaster is turned on, the digital display on the control box will read C--A for Celsius, and the "A" will begin to count down 9 seconds. During this countdown, you can change the temperature display from Celsius to Fahrenheit readings. To change temperature display, press and hold the temperature button for six seconds. See figure 1.

figure 1

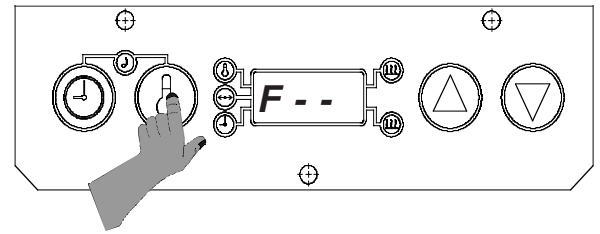

3. During the pre-heat cycle, the display will read -L O-. When the platen temperature reaches 149° C (300° F), the display will begin to show the actual platen temperatures throughout the toasting cycles. See figure 2.

figure 2

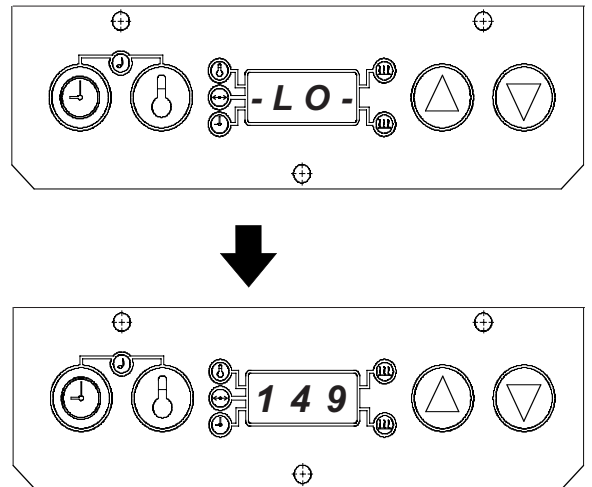

Sound Level Adjustment



The audio alarm has four sound levels.

1. Press and hold the time button and temperature buttons simultaneously. The display will show the current sound level. The toasters are factory set at level 4, and the display will read, **A L 4** for Alarm Level 4. See figure 3.

figure 3

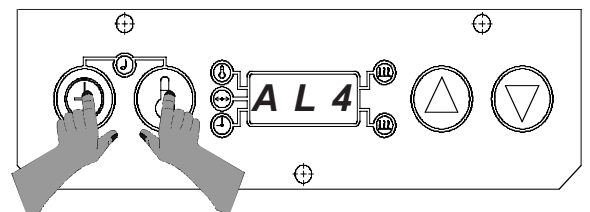

- While holding the time and temperature buttons, press the up or down arrow buttons to adjust the sound level. A continuous tone will sound. Release all buttons when the desired sound level is reached. The display will show the current sound level. See figure 4.

figure 4

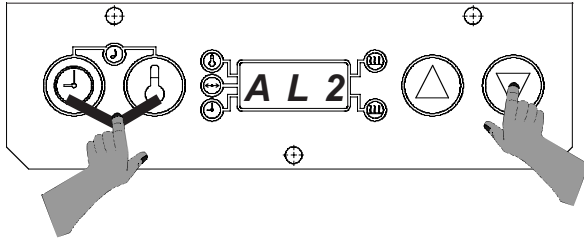

VIEW SET POINT TEMPERATURE

- Press and release the temperature button. (Do not hold for more than 6 seconds.) A beep will sound, the temperature indicator will turn on, and the display will show the set point temperature for three seconds. The display will then change to show the actual temperature. See figure 5.

figure 5

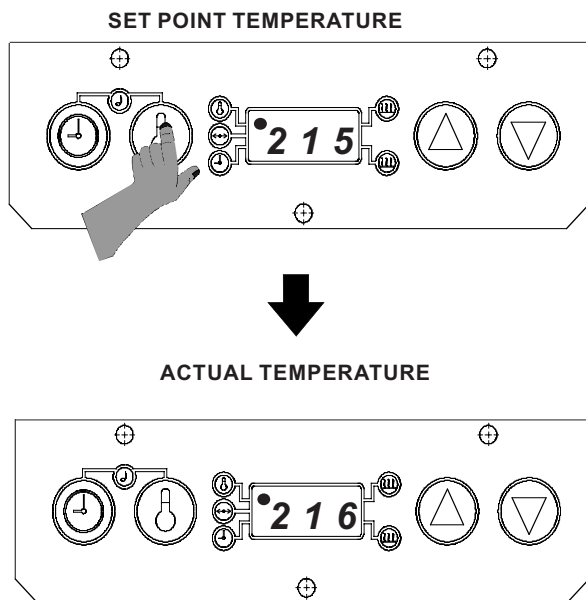

VIEW TIMER SETTING

- Press and release the time button. (Do not press the time button for more than 6 seconds.) The set time will be displayed for three seconds. If the timer is activated and is in a countdown sequence, the time remaining will be displayed, and will continue to countdown to zero. After three seconds, the display will change to show actual platen temperature. See figure 6.

figure 6

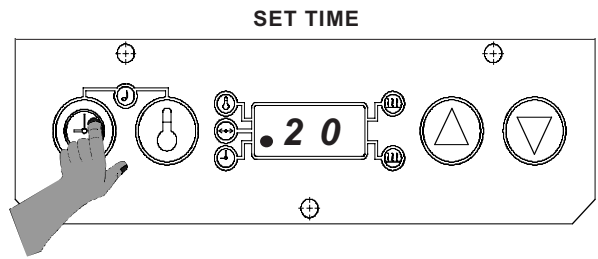

PROGRAMMING

The programming modes are used for setting individual set point temperature, and setting toast times.

Programming the Set Point Temperature

- Press and hold the temperature button for six seconds. A beep will sound, the temperature indicator light will blink, and the display will show the current set point temperature. See figure 7.

figure 7

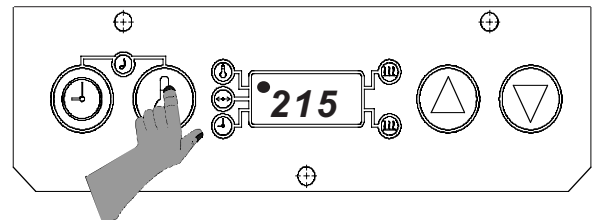

- To change the set point temperature, use the up or down arrow. Once the desired temperature is displayed, press the temperature button to store the new setting. See figure 8.

figure 8

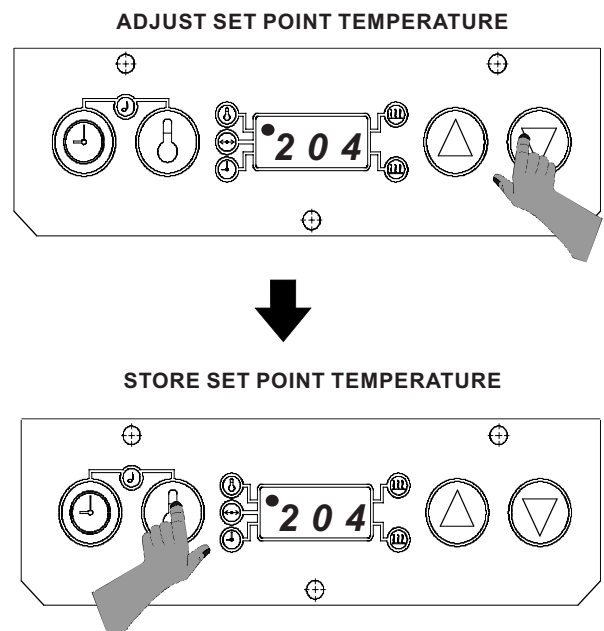

3. To cancel the set point programming mode at any time, press and release the time button. The display will change to show the actual platen temperature. See figure 9.

figure 9

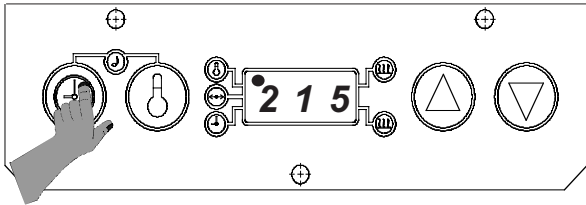

3. To cancel the time set function at any time, press and release the temperature button. The time indicator light will turn off, and the display will change to show the actual platen temperature. See figure 12.

figure 12

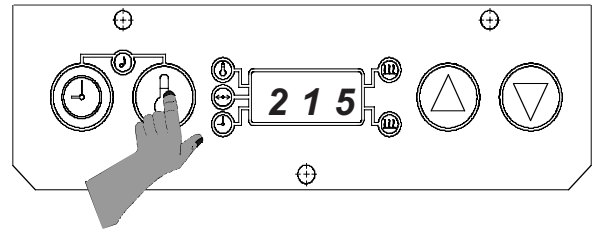

Programming Toast Times

1. Press and hold the time button for 6 seconds. A beep will sound, and the time indicator light will blink. Release the time button to show the current toast time. See figure 10.

figure 10

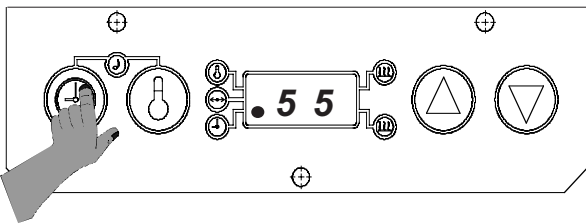

2. Use the up and down arrow buttons to set your desired toast time. The range is from 20 seconds to 1 minute, 30 seconds. When desired time is reached, press and release the time button to store the new time. See figure 11.

figure 11

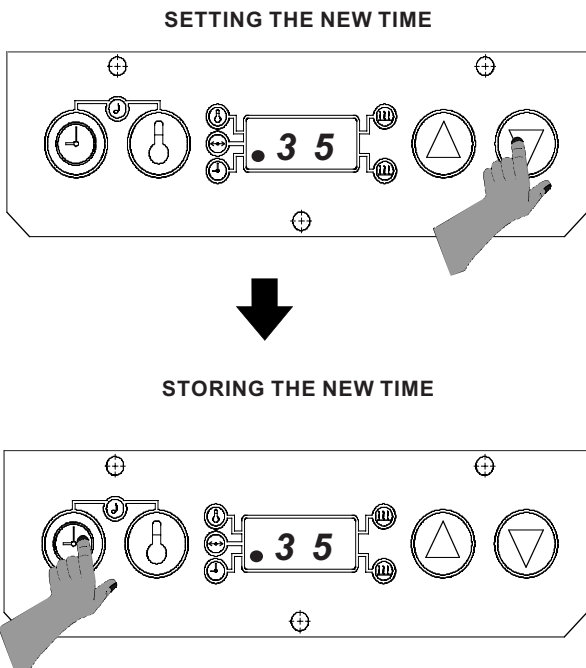

SETTING STOP BLOCKS

Stop blocks allow for proper crush when toasting buns. The toaster leaves the factory with the stop blocks set on R/Q.

Dual stop blocks allow you to switch back and forth from Reg/Qtr. bun and Big Mac Bun toasting, or Rib bun or Rye bun toasting.

1. Ensure the stop blocks are on the correct setting. There are (6) combination Stop Block Settings:

- | | |
|-----------------|-----------------|
| 1. R/Q / MAC | 4. RIB / RYE |
| 2. R/Q+ / MAC + | 5. RIB+ / RYE + |
| 3. R/Q- / MAC - | 6. RIB- / RYE - |

THE (+) SETTING IS FOR BUNS THAT ARE CUT TOO THICK. THE (-) SETTING IS FOR BUNS CUT TOO THIN. FOR NORMAL SIZE BUNS DO NOT USE (+) or (-) SETTINGS.

[R/Q = REG/QTR]

2. Rotate stop blocks by hand to the desired combination bun setting listed above.
3. View the stop block setting selected through the index window bracket, which is located over the left stop block. See figure 13.

figure 13

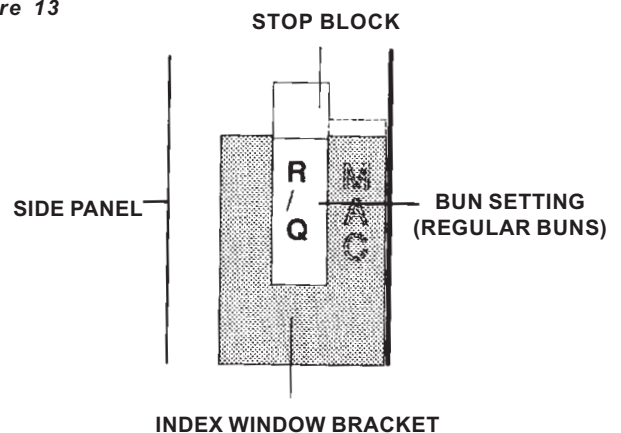

- To switch between the two types of buns per your stop block setting, locate the selector lever on the front of the toaster frame. Move the lever left or right to switch back and forth between the combination setting. See figure 14.

figure 14

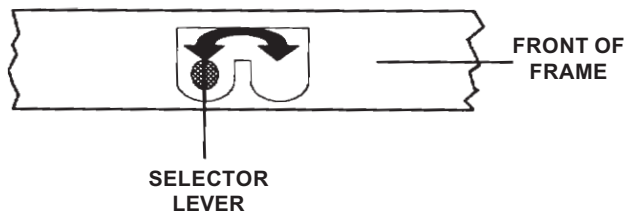
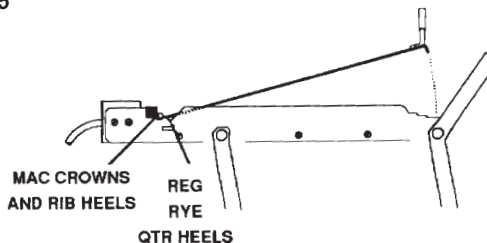

figure 15



BUN BOARD ADJUSTMENTS

- Push or pull the bun board handle to desired notched setting as indicated by graphics stamped on top of bun board. See figure 15.
- Bun board graphics are:
 FRONT = REG, RYE, QTR HEELS
 REAR = BIG MAC, (CROWNS) AND RIB HEELS

CLEANING

- Press the power switch to the off position.
- Unplug toaster.
- Allow toaster and platens to cool down.
- Wipe entire platen with clean, damp grill cloth. Full toaster cleaning must be done in the morning when toaster is cold. See your *Planned Maintenance Card* for proper cleaning procedures.

IMPORTANT: Do not drape cord over hot toaster bun board or platen. This will cause cord to burn.

TROUBLESHOOTING GUIDE

PROBLEM	CAUSE	SOLUTION
Platen loose.	Platen bolts loose.	Tighten platen bolts.
Speaker sounds, but no bun done light comes on.	Done light burned out.	Replace done light.
No audio alarm or amber colored bun "done" light.	Interconnect cable connection loose. Keyhole slot filled with debris. Speaker defective Opto-Sensor board defective	Check connections at Opto-Sensor board and main board. Clean keyhole slot. Replace speaker. Replace Opto-Sensor board.
Buns being crushed.	Stop blocks not adjusted properly. Warped bun trays. Buns cut improperly.	Adjust stop blocks. Straighten or replace bun trays. Contact bakery.
Platen does not heat.	No power. Power switch defective. Shorted power board. Platen burned out or shorted.	Check power source. Replace power switch. Replace power board. Check platen with ohmmeter for 11 ohms, if reading is less than 7 ohms or more than 14 ohms, replace platen.
No Display.	Fuse Defective.	Check fuse with ohmmeter, reading should be 1-2 ohms.

DIAGNOSTIC TROUBLESHOOTING

If the toaster malfunctions, the display will flash an error code **E** and a number between **1-9**, or a letter between **A-E**. Below are different error codes and their solutions. For Example If error code is **EO1**, a failure related to the lower platen controls has occurred. If error code is **E10** a failure related to the upper platen controls has occurred.

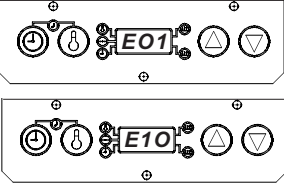
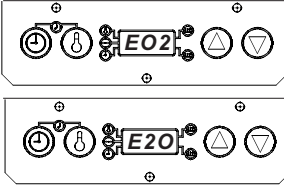
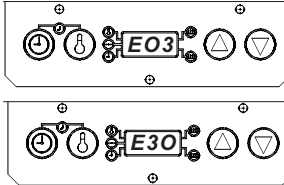
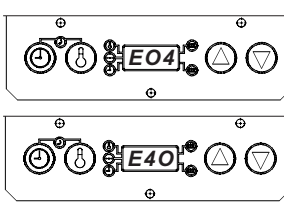
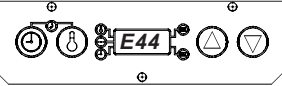
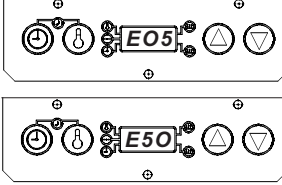
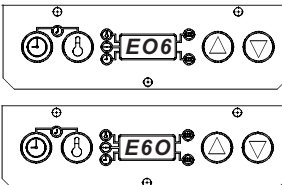
Diagnostics	Problem	Solution
	<p>1. Lower Relay Contacts Shorted. Lower Platen Overheating.</p> <p>1. Upper Relay Contacts Shorted. Upper Platen Overheating.</p>	<p>Replace Lower Relay. Replace P. C. Board.</p> <p>Replace Upper Relay. Replace P. C. Board.</p>
	<p>2. Lower Probe Open.</p> <p>2. Upper Probe Open</p>	<p>Replace Lower Probe.</p> <p>Replace Upper Probe.</p>
	<p>3. Lower Failures 1 And 2 Combined</p> <p>3. Upper Failures 1 And 2 Combined</p>	
	<p>4. Lower Platen Underheating.</p> <p>4. Upper Platen Underheating.</p>	<p>Replace Lower Relay. Check Lower Platen Resistance. Replace P. C. Board.</p> <p>Replace Upper Relay Check Upper Platen Resistance. Replace P. C. Board.</p>
	<p>Both Platens Underheating.</p> <p>2. A maximum of 900 sets of buns can be toasted in 1 hour, anything over that and the toaster can go into an E44 failure. If this happens discontinue using the toaster for 3 minutes and the failure will clear. You can then resume using the toaster again. If None of the above occurs, replace the P. C. Board.</p>	<p>1. Check For Cool Air Blowing On Toaster.</p>
	<p>5. Lower Failures 1 And 4 Combined.</p> <p>5. Upper Failures 1 And 4 Combined.</p>	
	<p>6. Lower Failures 2 And 4 Combined.</p> <p>6. Upper Failures 2 And 4 Combined.</p>	

 	<p>7. Lower Failures 1, 2 And 4 Combined.</p> <p>7. Upper Failures 1, 2 And 4 Combined.</p>	
 	<p>8. Lower Probe Circuit Failure.</p> <p>8. Upper Probe Circuit Failure.</p>	<p>Replace P. C. Board.</p> <p>Replace P. C. Board.</p>
 	<p>9. Lower Failures 1 And 8 Combined.</p> <p>9. Upper Failures 1 And 8 Combined.</p>	
 	<p>10. Lower Failures 2 And 8 Combined.</p> <p>10. Upper Failures 2 And 8 Combined.</p>	
 	<p>11. Lower Failures 1, 2 And 8 Combined.</p> <p>11. Upper Failures 1, 2 And 8 Combined.</p>	
 	<p>12. Lower Failures 4 And 8 Combined.</p> <p>12. Upper Failures 4 And 8 Combined.</p>	
 	<p>13. Lower Failures 1, 4 And 8 Combined.</p> <p>13. Upper Failures 1, 4 And 8 Combined.</p>	
 	<p>14. Lower Failures 2, 4 And 8 Combined.</p> <p>14. Upper Failures 2, 4 And 8 Combined.</p>	

SYMBOLES ET TERMES

- C -- A** Le grille-pain est réglé sur Celsius.
F -- A Le grille-pain est réglé sur Fahrenheit.
AL - Réglage du niveau d alarme 1-4.



Touche de son : utilisée avec la touche de minuterie et la touche de température afin de fixer le niveau d alarme.



Touche de minuterie : utilisée pour examiner la durée en mode opération. Utilisée pour fixer la durée en mode programme.



Touche de température : utilisée pour examiner la température de point de repère en mode opération, et utilisé pour fixer la température de point de repère en mode programme.



Flèche ascendante : utilisée pour fixer la durée, le son et la température en mode programme.



Flèche descendante : utilisée pour fixer la durée, le son et la température en mode programme.

PRE-REGLAGE EN USINE

Les grille-pain Prince Castle à affichage numérique d état solide sont pré-réglés en usine.

Si votre modèle de grille-pain est réglé pour une durée de toasting de 35 secondes, la température est pré-réglée et étalonnée à 215°C.

Si votre modèle votre grille-pain est réglé pour une durée de toasting de 55 secondes, la température est pré-réglée et étalonnée à 204°C.

INSTALLATION

- Se référer à la plaque d identification sur la boîte de commandes afin de connaître la tension correcte de fonctionnement. Raccorder le grille-pain à une prise de courant mise à la terre qui corresponde à l information sur la tension, indiquée sur la plaque d identification. Appuyer sur l interrupteur d alimentation pour le mettre en position MARCHE, et laisser l appareil 30 minutes en opération afin qu il atteigne sa température de fonctionnement.
- Le grille-pain est pré-réglé en usine afin d afficher des relevés de température en Celsius. Lorsque le grille-pain est allumé, l affichage numérique sur la boîte de commandes sera C -- A pour les Celsius, et le "A" commencera à décompter 9 secondes. Pendant ce décompte, vous pouvez changer l affichage de température des Celsius en Fahrenheit. Pour changer l affichage de température, appuyer et maintenir la touche de température pendant six secondes. Voir la figure 1.

figure 1

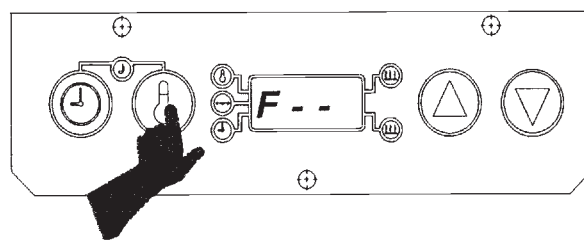

- Pendant le cycle de préchauffage, l affichage indiquera **L O -**. Lorsque la température des plaques atteint 149°C (300°F), l affichage commencera à indiquer les températures réelles des plaques pour tous les cycles de toasting. Voir la figure 2.

figure 2

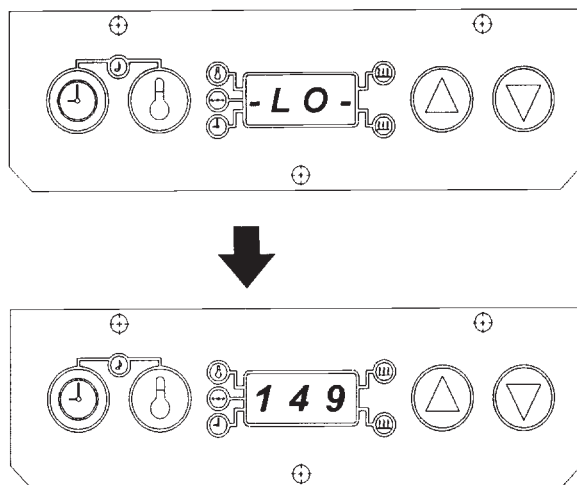

Réglage du niveau du son



L alarme sonore possède quatre niveaux.

- Appuyer et maintenir simultanément les touches de durée et de température. L affichage indiquera le niveau de son en cours. Les grille-pain sont pré-réglés en usine au niveau 4, et l affichage indiquera **AL 4**, ce qui signifie Niveau d Alarme 4. Voir la figure 3.

figure 3

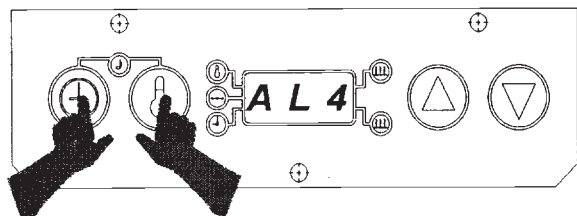

2. Tout en maintenant les touches de durée et de température, appuyer sur les touches de flèche ascendante et flèche descendante afin de fixer le niveau sonore. Une tonalité continue se fera entendre. Relâcher toutes les touches lorsque le niveau de tonalité désiré est atteint. L'affichage indiquera le niveau sonore en cours. Voir la figure 4.

figure 4

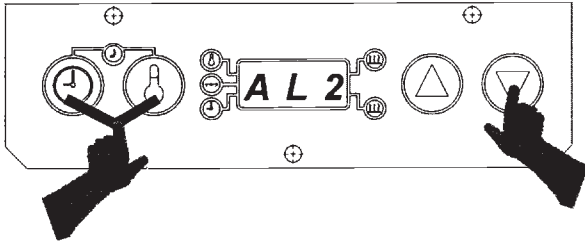

EXAMEN DE LA TEMPERATURE DE POINT DE REPERE

1. Appuyer et relâcher la touche de température. (Ne pas la maintenir pendant plus de 6 secondes). Un bip se fera entendre, l'indicateur de température s'allumera et l'affichage indiquera la température de point de repère pendant trois secondes. L'affichage changera ensuite afin d'indiquer la température en cours. Voir la figure 5.

figure 5

REGLAGE DE LA TEMPERATURE DE POINT DE REPERE

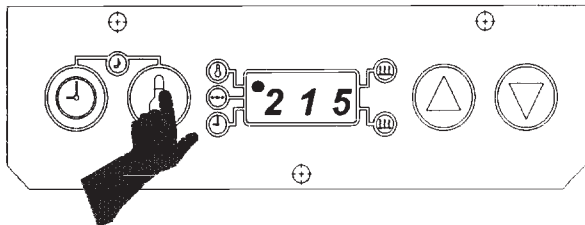

TEMPERATURE EN COURS

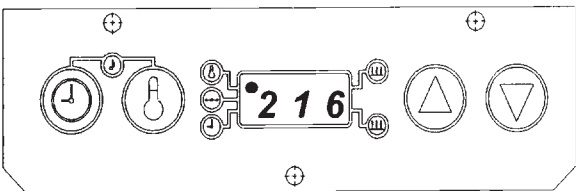

EXAMEN DU REGLAGE DE MINUTERIE

1. Appuyer et relâcher la touche de durée. (Ne pas appuyer pendant plus de 6 secondes). La durée réglée s'affichera pendant trois secondes. Si la minuterie est activée et en séquence de décompte, la durée restante sera affichée, et continuera de décompter jusqu'à zéro. Après trois secondes, l'affichage changera afin d'indiquer les températures présentes de plaque. Voir la figure 6.

figure 6

REGLAGE DE LA DUREE

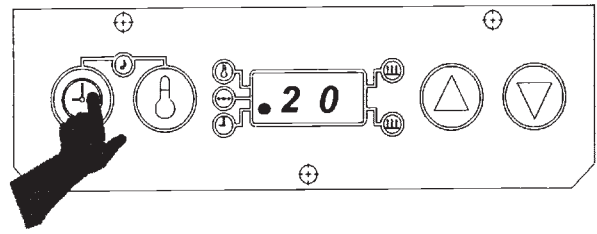

PROGRAMMATION

Les modes de programmation sont utilisés pour fixer la température des points de repère individuels, et pour fixer les durées de toasting.

Programmation de la température des points de repère

1. Appuyer et maintenir la touche de température pendant 6 secondes. Un bip se fera entendre, la lumière de l'indicateur de température clignotera et l'affichage indiquera la température du point de repère en cours. Voir la figure 7.

figure 7

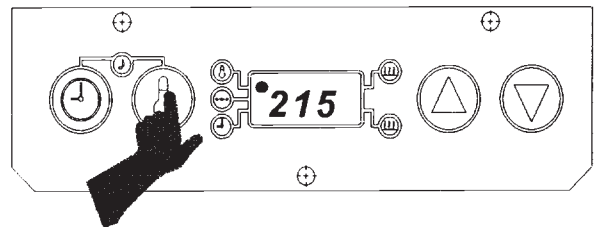

2. Pour changer la température du point de repère, utiliser les flèches ascendante et descendante. Une fois que la température désirée est indiquée, appuyer sur la touche de température afin de mettre en mémoire le nouveau réglage. Voir la figure 8.

figure 8

REGLAGE DE LA TEMPERATURE DE POINT DE REPERE

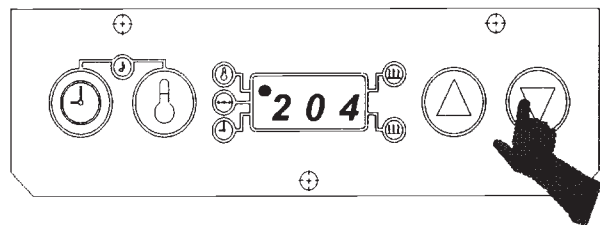

MISE EN MEMOIRE DE LA TEMPERATURE DE POINT DE REPERE

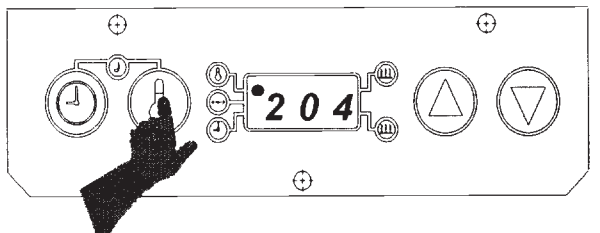

3. Pour annuler le mode de programmation du point de repère à n importe quel moment, appuyer et relâcher la touche de durée. L affichage changera pour indiquer la température de plaque en cours. Voir la figure 9.

figure 9

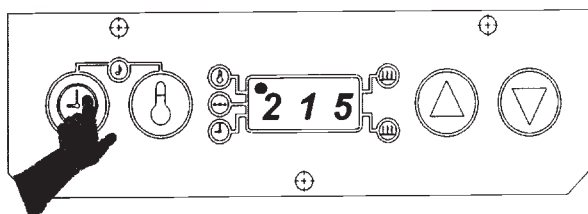

Programmation des durées de toasting

1. Appuyer et maintenir la touche de durée pendant 6 secondes. Un bip se fera entendre, la lumière de l indicateur de durée clignotera. Relâcher la touche de durée afin d indiquer la durée du toasting en cours. Voir la figure 10.

figure 10

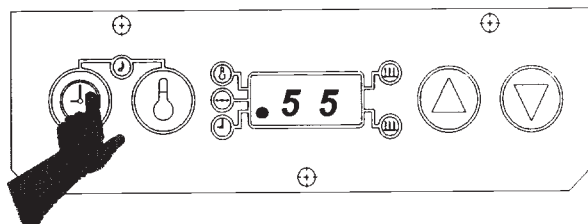

2. Utiliser les touches de flèches ascendante et descendante afin de fixer votre durée de toasting désirée. La gamme est de 20 secondes à 1 minute et 30 secondes. Une fois que la durée désirée est atteinte, appuyer et relâcher la touche de durée afin de mettre en mémoire la nouvelle durée. Voir la figure 11.

figure 11

REGLAGE DE LA NOUVELLE DUREE

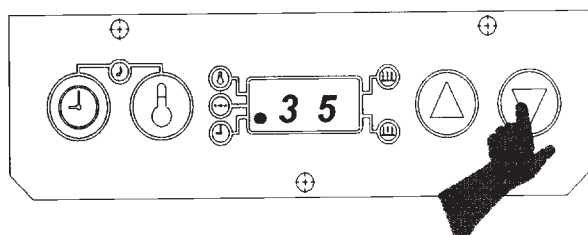

MISE EN MEMOIRE DE LA NOUVELLE DUREE

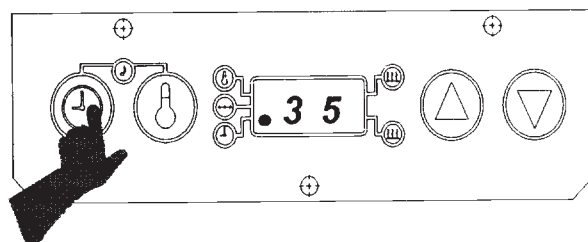

3. Pour annuler à n importe quel moment la fonction de réglage de durée, appuyer et relâcher la touche de température. La lumière de l indicateur de durée s éteindra et l affichage changera afin d indiquer la température de plaque en cours. Voir la figure 12.

figure 12

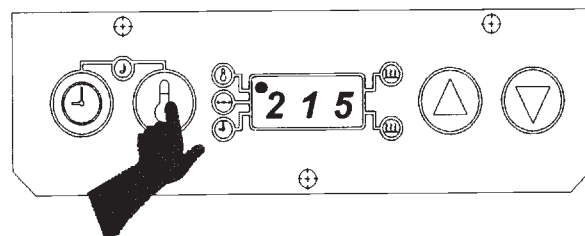

REGLAGE DES BLOCS D ARRÊT

Les blocs d arrêt permettent un maintien correct lorsque l on grille des petits pains. Le grille-pain quitte l usine avec les blocs d arrêt réglés sur le numéro trois. Les blocs d arrêt se situent vers l avant du grille-pain sur les côtés droit et gauche de la base. Pour augmenter le maintien, fixer les blocs d arrêt sur le numéro 2. Pour diminuer le maintien, fixer les blocs d arrêt sur le numéro 4. Voir la figure 13.

figure 13

REGLAGE DES BLOCS D ARRÊT

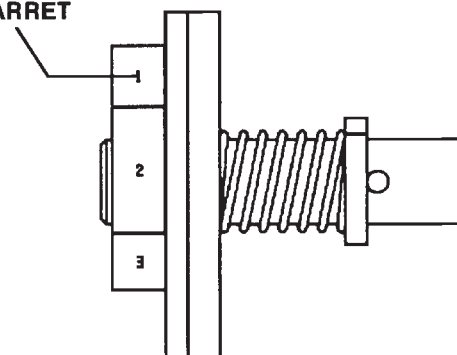

IMPORTANT: Les blocs d arrêt sont réglés sur le chiffre qui touche le levier. L exemple dans la figure 13 indique un réglage de bloc d arrêt de 1.

1. Pour changer le réglage du bloc d arrêt, abaisser le bloc d arrêt droit et retirer la cheville d arrêt. Tourner le bloc d arrêt jusqu au réglage correct.

NETTOYAGE

1. Placer l'interrupteur d'alimentation en position ARRET.
2. Débrancher le grille-pain.
3. Laisser le grille-pain et les plaques se refroidir.
4. Essuyer entièrement les plaques avec un chiffon pour grill propre et humide. Le nettoyage entier du grille-pain doit s'effectuer le matin lorsque le grille-pain est froid. Examiner votre *Carte de Planification d'Entretien* afin de connaître les procédures correctes de nettoyage.



IMPORTANT: Ne pas enrouler le fil autour du panneau ou des plaques de grille-pain pour petits pains lorsqu'ils sont chauds. Le fil pourrait brûler.

GUIDE DE DEPANNAGE

PROBLEME	CAUSE	SOLUTION
Les plaques sont déserrées.	Les boulons des plaques sont déserrés.	Les reserrer.
La sonnerie retentit, mais la lumière indiquant que les petits pains sont faits ne s'allume pas.	La lampe est brûlée.	Remplacer la lampe.
La sonnerie ne retentit pas et la lumière indiquant que les petits pains sont faits ne s'allume pas.	L'interrupteur de la minuterie est défectueux. Le raccord de la minuterie est court-circuité sur le panneau d'alimentation L'interrupteur de la minuterie n'est pas activé.	Remplacer l'interrupteur de minuterie. Remplacer le panneau d'alimentation. Vérifier le support d'activation afin de vous assurer qu'il pousse l'interrupteur de la minuterie jusqu'au bout
Les petits pains sont écrasés.	Les blocs d'arrêt ne sont pas réglés correctement. Les plateaux pour petits pains sont ondulés. Les petits pains ne sont pas coupés correctement.	Régler les blocs d'arrêt. Redresser ou remplacer les plateaux pour petits pains. Contacter la boulangerie.
Les plaques ne chauffent pas.	Il n'y a pas d'alimentation. L'interrupteur d'alimentation est défectueux. Le panneau d'alimentation est court-circuité. Les plaques sont brûlées ou court-circuitées.	Vérifier la source d'alimentation. Remplacer l'interrupteur d'alimentation. Remplacer le panneau d'alimentation. Vérifier les plaques avec un ohmmètre pour 11 ohms. Si le relevé est inférieur à 7 ohms ou supérieur à 14 ohms, remplacer les plaques.
Pas d'affichage	Le fusible est défectueux.	Vérifier le fusible avec l'ohmmètre. Le relevé devrait être de 1-2 ohms

DEPANNAGE DIAGNOSTIQUE

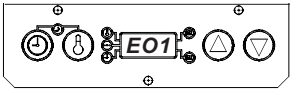
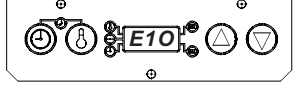
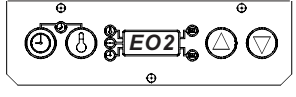
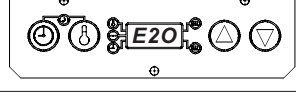
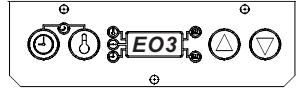
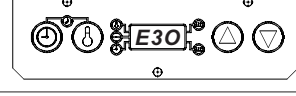
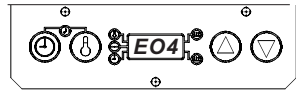
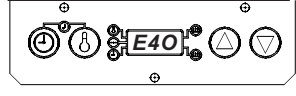
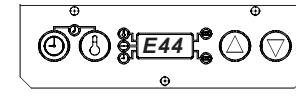
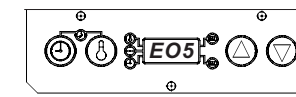
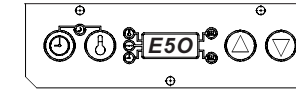
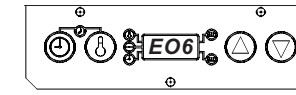
Si le grille-pain ne fonctionne pas correctement, l'affichage indiquera un code erreur **E** clignotant et un numéro entre **1 et 9**, ou une lettre entre **A et F**. Ci-dessous sont indiqués les différents codes erreur et leurs solutions. Par exemple, si le code erreur est **E01**, une panne est survenue qui se rapporte aux commandes des plaques inférieures. Si le code erreur est **E10**, une panne est survenue qui se rapporte aux commandes des plaques supérieures.

Diagnostic	Problème	Solution
 	<p>1. Les contacts de relais inférieurs sont court-circuités. Les plaques inférieures surchauffent.</p> <p>1. Les contacts de relais supérieurs sont court-circuités. Les plaques supérieures surchauffent.</p>	<p>Remplacer le relais inférieur. Remplacer le panneau circuit sonde.</p> <p>Remplacer le relais supérieur. Remplacer le panneau circuit sonde.</p>
 	<p>2. La sonde inférieure est ouverte.</p> <p>2. La sonde supérieure est ouverte.</p>	<p>Remplacer la sonde inférieure.</p> <p>Remplacer la sonde supérieure.</p>
 	<p>3. Les pannes inférieures 1 et 2 sont combinées.</p> <p>3. Les pannes supérieures 1 et 2 sont combinées.</p>	
 	<p>4. Réchauffement insuffisant des plaques inférieures.</p> <p>4. Réchauffement insuffisant des plaques supérieures.</p>	<p>Remplacer le relais inférieur. Vérifier la résistance des plaques inférieures.</p> <p>Remplacer le panneau circuit sonde. Remplacer le relais supérieur. Vérifier la résistance des plaques supérieures. Remplacer le panneau circuit sonde.</p>
	<p>Réchauffement insuffisant des deux plaques.</p> <p>2. Un maximum de 900 jeux de petits pains peut être grillé en 1 heure. Pour une quantité supérieure, le grille-pain pourrait se mettre en panne E44. Si ceci se produit, laisser le grille-pain refroidir pendant 3 minutes et la panne disparaîtra. Vous pourrez recommencer à utiliser le grille-pain. Si aucune panne ci-dessus ne se produit, remplacer le panneau circuit sonde.</p>	<p>Vérifier le flux d'air frais sur le grille-pain.</p>
 	<p>5. Les pannes inférieures 1 et 4 sont combinées.</p> <p>5. Les pannes supérieures 1 et 4 sont combinées.</p>	
 	<p>6. Les pannes inférieures 2 et 4 sont combinées.</p> <p>6. Les pannes supérieures 2 et 4 sont combinées.</p>	

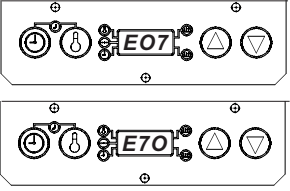
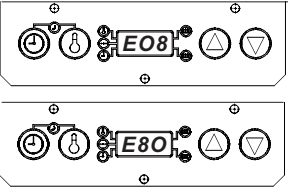
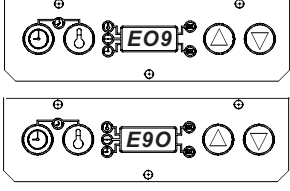
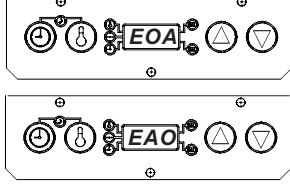
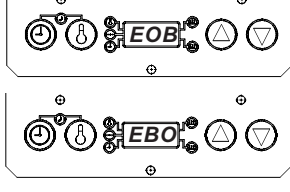
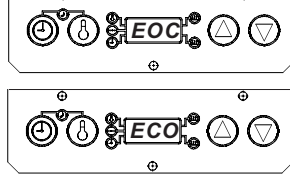
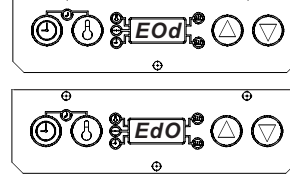
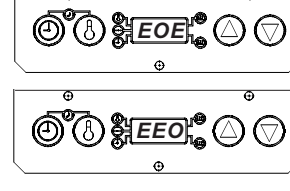
	<p>7. Les panes inférieures 1, 2 et 4 sont combinées.</p> <p>7. Les panes supérieures 1, 2 et 4 sont combinées.</p>	
	<p>8. Panne de circuit sonde inférieur.</p> <p>8. Panne de circuit sonde supérieur.</p>	<p>Remplacer le panneau circuit sonde.</p> <p>Remplacer le panneau circuit sonde.</p>
	<p>9. Les panes inférieures 1 et 8 sont combinées.</p> <p>9. Les panes supérieures 1 et 8 sont combinées.</p>	
	<p>10. Les panes inférieures 2 et 8 sont combinées.</p> <p>10. Les panes supérieures 2 et 8 sont combinées.</p>	
	<p>11. Les panes inférieures 1, 2 et 8 sont combinées.</p> <p>11. Les panes supérieures 1, 2 et 8 sont combinées.</p>	
	<p>12. Les panes inférieures 4 et 8 sont combinées.</p> <p>12. Les panes supérieures 4 et 8 sont combinées.</p>	
	<p>13. Les panes inférieures 1, 4 et 8 sont combinées.</p> <p>13. Les panes supérieures 1, 4 et 8 sont combinées.</p>	
	<p>14. Les panes inférieures 2, 4 et 8 sont combinées.</p> <p>14. Les panes supérieures 2, 4 et 8 sont combinées.</p>	

SYMBOLS & BEGRIFFE

- C--A** Der Toaster ist auf Celsius eingestellt.
- F--A** Der Toaster ist auf Fahrenheit eingestellt.
- AL-** Signalton-Einstellung 1-4.



Signal-Taste: Wird mit der Timer- und der Temperatur-Taste verwendet, um den Signalpegel einzustellen.



Timer-Taste: Zum Anzeigen der Zeit im Betriebsmodus. Zum Einstellen der Zeit im Programmier-Modus.



Temperatur-Taste: Zur Anzeige der Betriebs-Temperatur im Betriebsmodus und zur Einstellung der Betriebs-Temperatur im Programmier-Modus.



Pfeil nach oben: Zur Einstellung der Zeit, Signalpegel und Temperatur im Programmier-Modus.



Pfeil nach unten: Zur Einstellung der Zeit, Signalpegel und Temperatur im Programmier-Modus.

EINSTELLUNGEN AB WERK

Die Toaster mit digitaler Elektronik Anzeige von Prince Castle sind ab Werk voreingestellt.

Beträgt die Toaszeit Ihres Toasters 35 Sekunden, so ist die Betriebstemperatur auf 215°C eingestellt.

Beträgt die Toaszeit Ihres Toasters 55 Sekunden, so ist die Betriebstemperatur, auf 204°C eingestellt.

AUFBAU

1. Die korrekte Spannung ist auf dem Typenschild des Steuergehäuses angegeben. Schließen Sie den Toaster an eine geerdete Steckdose mit der entsprechend auf dem Typenschild angegeben Spannung an. Bedienen Sie den Netzschalter und warten Sie 30 Minuten bis das Gerät die Betriebstemperatur erreicht hat.
2. Ab Werk zeigt der Toaster die Temperatur in Celsius an. Bei Einschalten des Toasters wird im digitalen Display des Steuergehäuses C A angezeigt und der Buchstabe A schaltet auf einen 9 Sekunden Count-Down. Während diesem Count-Down kann die Anzeige von Celsius auf Fahrenheit umgeschaltet werden. Dieses Umschalten wird durch Halten der Temperatur-Taste für 6 Sekunden erreicht. Siehe abbildung 1.

abbildung 1

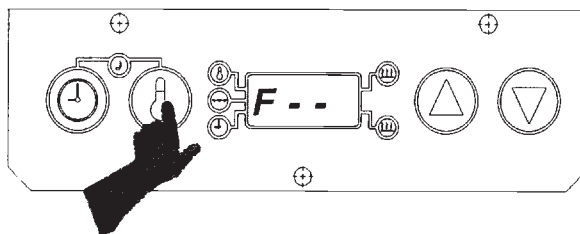

3. Während dem Aufheizen wird im Display **LO-** angezeigt. Sobald die Heizplatten eine Temperatur von 149°C (300°F) erreicht haben, zeigt das Display die eigentliche Temperatur der Heizplatten an. Siehe abbildung 2.

abbildung 2

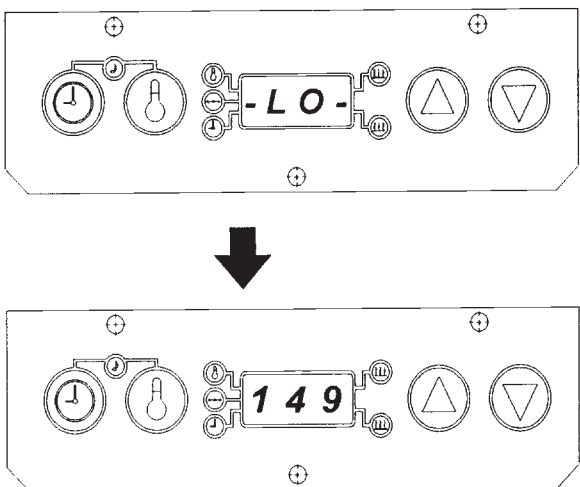

Einstellen des Signalpegels



Das akustische Signal verfügt über 4 verschiedene Lautstärken.

1. Halten Sie die Timer- und die Temperatur-Tasten gedrückt und das Display zeigt den eingestellten Signalpegel an. Die Toaster sind ab Werk auf Pegel 4 eingestellt, deshalb wird im Display **AL 4** für den Signalpegel 4 angezeigt. Siehe abbildung 3.

abbildung 3

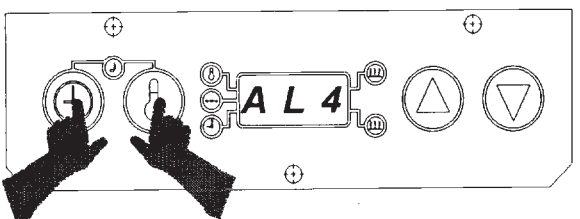

2. Während dem Halten der Time- und Temperatur-Tasten kann der Signalpegel mit den Pfeiltasten eingestellt werden. Bei dieser Einstellung wird ein konstantes Signal ertönen. Lassen Sie alle Tasten los, wenn der gewünschte Signalpegel eingestellt ist. Das Display wird nun den neuen Signalpegel anzeigen. Siehe abbildung 4.

abbildung 4

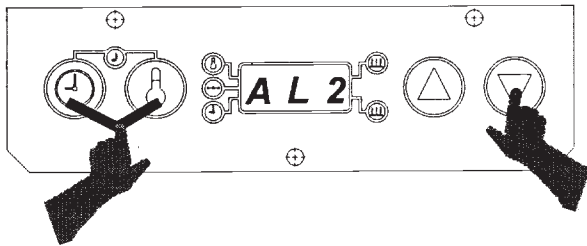

ANZEIGEN DER BETRIEBSTEMPERATUR

1. Bedienen Sie kurz die Temperatur-Taste (nicht für länger als 6 Sekunden gedrückt halten). Ein Signal ertönt, das Temperatursymbol erscheint und das Display zeigt die eingestellte Betriebstemperatur für 3 Sekunden an. Danach schaltet das Display auf die momentane erreichte Temperatur um. Siehe abbildung 5.

abbildung 5

BETRIEBS-TEMPERATUR

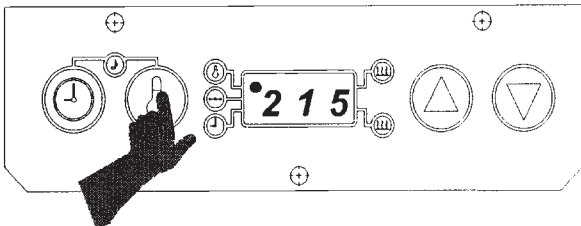

ERREICHTE TEMPERATUR

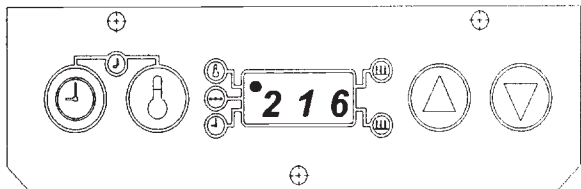

ANZEIGEN DER TIMER-EINSTELLUNGEN

1. Bedienen Sie kurz die Time-Taste (nicht für länger als 6 Sekunden gedrückt halten). Die eingestellte Zeit wird für 3 Sekunden angezeigt. Ist der Timer aktiviert und befindet sich dieser in einem Count-Down, schaltet das Display auf die verbleibende Toast-Zeit um und der Count-Down läuft weiterhin ab. Nach 3 Sekunden schaltet das Display auf die Anzeige der erreichten Heizplatten-Temperatur zurück. Siehe abbildung 6.

abbildung 6

EINSTELLEN DER ZEIT

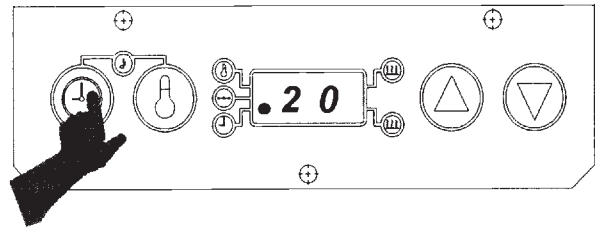

PROGRAMMIERUNG

Der Programmier-Modus wird zum Einstellen der individuellen Betriebstemperaturen und der Toast-Zeit verwendet.

Programmierung der Betriebstemperatur

1. Halten Sie die Temperatur-Taste für 6 Sekunden gedrückt. Ein Signal wird ertönen, das Temperatursymbol blinkt und das Display wird die bisher eingestellte Betriebstemperatur anzeigen. Siehe abbildung 7.

abbildung 7

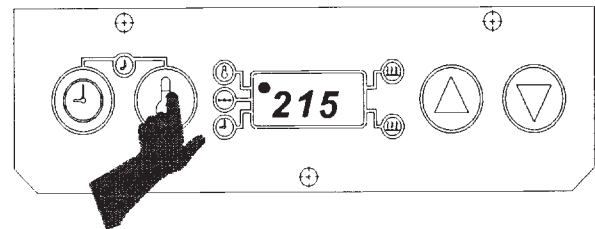

2. Die Betriebstemperatur kann mit den Pfeil-Tasten eingestellt werden. Sobald die gewünschte Betriebstemperatur angezeigt wird, bedienen Sie die kurz die Temperatur-Taste, um diese neue Einstellung zu speichern. Siehe abbildung 8.

abbildung 8

EINSTELLEN DER BETRIEBS-TEMPERATUR

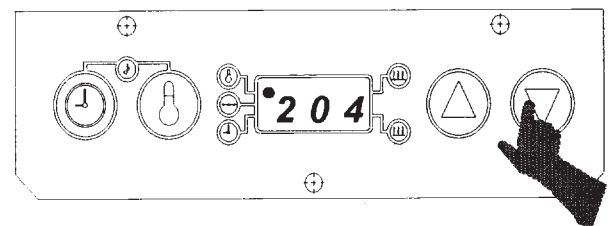

SPEICHERN DER BETRIEBS-TEMPERATUR

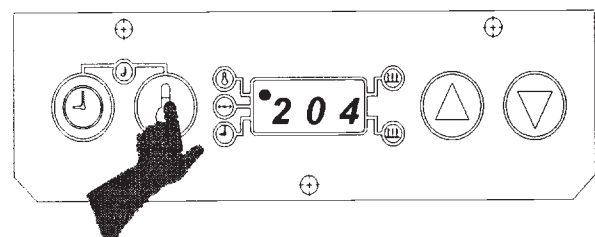

- Die Programmierung der Betriebs-Temperatur kann jederzeit durch kurzes Bedienen der Time-Taste abgebrochen werden. Das Display wird dann auf die Anzeige der erreichten Heizplatten-Temperatur umschalten. Siehe abbildung 9.

abbildung 9

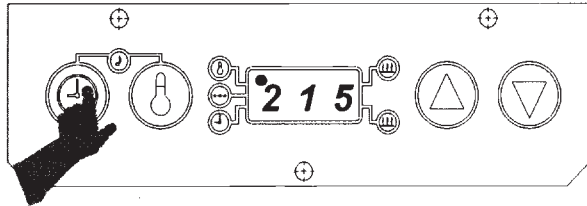

Programmieren der Toastzeit

- Halten Sie die Time-Taste für 6 Sekunden gedrückt. Ein Signal wird ertönen und das Time-Symbol wird blinken. Lassen Sie die Taste los und das Display wird die eingestellte Toast-Zeit anzeigen. Siehe abbildung 10.

abbildung 10

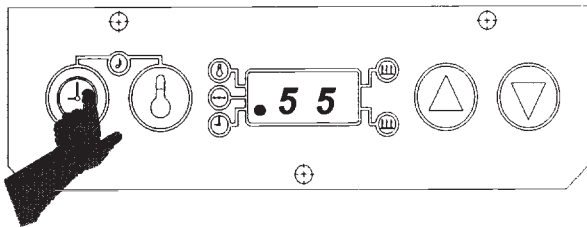

- Die Toast-Zeit kann mit den Pfeil-Tasten eingestellt werden. Die Zeitgrenzen liegen zwischen 20 und 90 Sekunden. Sobald die gewünschte Toast-Zeit angezeigt wird, bedienen Sie kurz die Time-Taste, um diese neue Einstellung zu speichern. Siehe abbildung 11.

abbildung 11

EINSTELLEN DER NEUEN TOAST-ZEIT

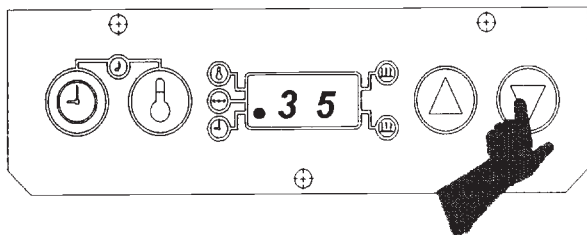

SPEICHERN DER NEUEN TOAST-ZEIT

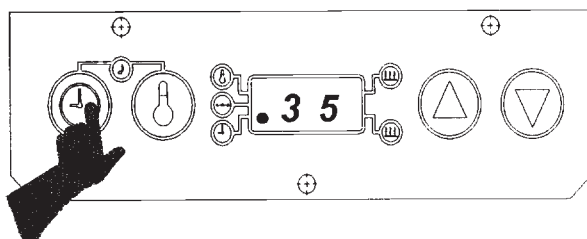

- Die Programmierung der Toast-Zeit kann jederzeit durch kurzes Bedienen der Temperatur-Taste abgebrochen werden. Das Time-Symbol wird erlöschen und das Display wird dann auf die Anzeige der erreichten Heizplatten-Temperatur umschalten. Siehe abbildung 12.

abbildung 12

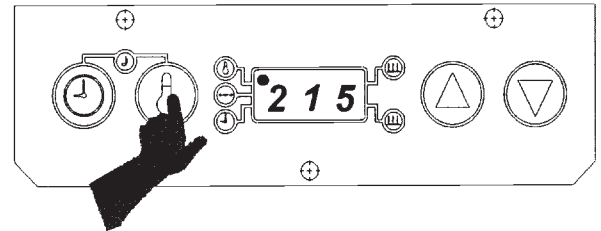

EINSTELLEN DER ANSCHLÄGE

Die Anschläge ermöglichen das korrekte Andrücken der Brötchen während dem Toasten. Ab Werk ist der Anschlag des Toasters auf die Position Nr. 3 eingestellt. Die Anschläge befinden sich an der vorderen Seite des Toasters auf der linken und rechten Seite des Sockels. Um den Andruck zu erhöhen können die Anschläge auf die Nr. 2 gestellt werden. Um weniger Andruck zu erhalten können die Anschläge auf die Nr. 4 gestellt werden. Siehe abbildung 13.

abbildung 13

ANSCHLAGS-TELLUNG

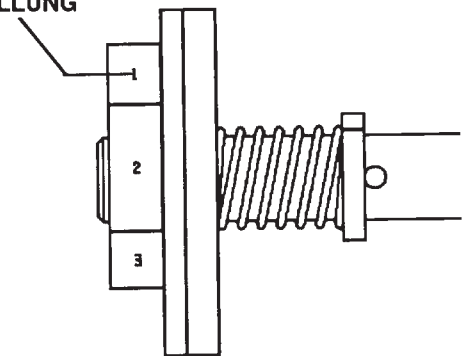

WICHTIG: Die Anschlagstellung, welche mit dem Hebel in berührung ist, ist der gewählte Anschlag. Das Beispiel in Abbildung 13 zeigt eine Einstellung des Anschlags auf Position Nr. 1.

- Um die Einstellung des Anschlags zu ändern, den rechten Anschlag eindrücken, die Sicherung mit dem Feststift lösen und in beliebiger Richtung bis zur richtigen Einstellung drehen.

REINIGUNG

1. Schalten Sie den Netzschalter aus.
2. Ziehen Sie den Netzstecker aus der Steckdose.
3. Lassen Sie den Toaster und die Heizplatten abkühlen.
4. Wischen Sie die gesammte Heizplatte mit einem sauberen und feuchten Grilltuch ab. Die Vollreinigung des Toasters muß am Morgen erfolgen, wenn der Toaster noch kalt ist. Für diese Reinigungsvorgänge beziehen Sie sich auf die entsprechende Karte für geplante Wartung.







WICHTIG: Um das Verbrennen des Kabels zu vermeiden, hängen Sie das Netzkabel nicht über ein heißes Brötchen Tablett oder eine heiße Heizplatte.

FEHLERSUCHE

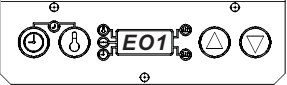
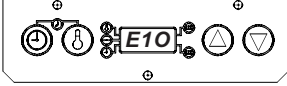
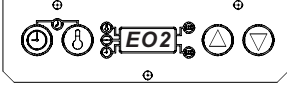
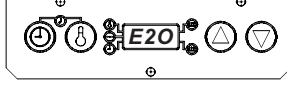
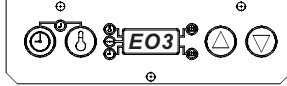
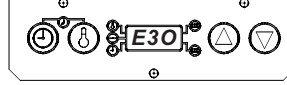
PROBLEM	URSACHE	BEHEBUNG
Heizplatte ist lose.	Schrauben der Heizplatten sind lose.	Schrauben nachziehen.
Das Signal ertönt aber die "Bun Done" Anzeige erleuchtet nicht.	"Bun Done" Lampe ist defekt.	Glühbirne austauschen.
Das Signal ertönt nicht und die "Bun Done" Anzeige erleuchtet nicht.	Der Timer-Schalter ist defekt. Der Timer-Anschluß auf der Stromversorgungs-Platine ist kurzgeschlossen. Der Timer-Schalter schaltet nicht.	Timer-Schalter austauschen Stromversorgungsplatine austauschen Halterung prüfen, der Schalter muß völlig eingedrückt werden.
Brötchen werden zerdrückt.	Anschläge sind nicht korrekt eingestellt. Die Brötchentabletts sind verbogen. Brötchen sind nicht korrekt geschnitten.	Anschläge einstellen Brötchentabletts gerade ausrichten oder austauschen Mit der Bäckerei Kontakt aufnehmen
Heizplatte wird nicht heiß.	Spannungsunterbrechung. Der Netzschalter ist defekt. Die Stromversorgungsplatine hat einen Kurzschluss. Die Heizplatte ist durchgebrannt oder kurzgeschlossen.	Stromquelle prüfen. Netzschalter austauschen Stromversorgungsplatine austauschen Heizplatte mit einem Ohm-Meter auf 11 Ohm prüfen. Sollte der Messwert weniger als 7 Ohm bzw. mehr als 14 Ohm betragen muß die Heizplatte ausgetauscht werden.
keine Anzeige	Die Sicherung ist durchgebrannt	Die Sicherung mit einem Ohm-Meter prüfen. Der Messwert sollte 1-2 Ohm betragen.

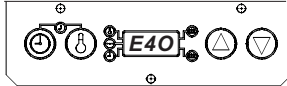
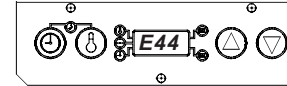
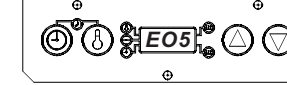
DIAGNOSE UND FEHLERSUCHE

Sollte der Toaster nicht funktionsfähig sein blinkt in der Anzeige ein Fehler-Code (**E**) und eine Nummer zwischen **1 bis 9** oder ein Buchstabe von **A bis E**. Nachfolgend sind die Fehler-Codes und deren Behebung aufgeführt. Ist der Fehler-Code zum Beispiel **E01**, liegt ein Fehler der unteren Heizplatte vor. Sollte der Fehler-Code **E10** nagezeigt werden, liegt ein Fehler der oberen Heizplatte vor.

Diagnose	Ursache	Behebung
 	<p>1. Kontakte des unteren Relais sind kurzgeschlossen. Untere Heizplatte überhitzt.</p> <p>1. Kontakte des oberen Relais sind kurzgeschlossen. Obere Heizplatte überhitzt.</p>	<p>Unteres Relais austauschen. Platine austauschen.</p> <p>Oberes Relais austauschen. Platine austauschen.</p>
 	<p>2. Unterbrechung des unteren Temperaturfühlers</p> <p>2. Unterbrechung des oberen Temperaturfühlers</p>	<p>Unteren Temperaturfühler austauschen</p> <p>Oberen Temperaturfühler austauschen</p>
 	<p>3. Fehler Nr. 1 & 2 der unteren Heizplatte treten gleichzeitig auf</p> <p>3. Fehler Nr. 1 & 2 der oberen Heizplatte treten gleichzeitig auf</p>	
 	<p>4. Untere Heizplatte erreicht nicht die gewünschte Temperatur</p> <p>4. Obere Heizplatte erreicht nicht die gewünschte Temperatur</p>	<p>Unteres Relais austauschen. Widerstand der unteren Heizplatte prüfen. Platine austauschen.</p> <p>Oberes Relais austauschen. Widerstand der oberen Heizplatte prüfen. Platine austauschen.</p>
	<p>Beide Heizplatten erreichen nicht die gewünschte Temperatur</p>	<p>1. Auf kalte Zugluft um den Toaster prüfen.</p> <p>2. Maximal können 900 Brötchen pro Stunde getoasted werden. Wird diese Anzahl überschritten kann der Toaster den Fehler-Code E44 anzeigen. In solch einem Fall den Toaster für ca. 3 Minuten nicht verwenden, somit wird der Fehler von selbst gelöscht. Danach kann der Toaster weiter verwendet werden. Sollte dies nicht zutreffen muss die Platine ersetzt werden.</p>
 	<p>5. Fehler Nr. 1 & 4 der unteren Heizplatte treten gleichzeitig auf.</p> <p>5. Fehler Nr. 1 & 4 der oberen Heizplatte treten gleichzeitig auf.</p>	
 	<p>6. Fehler Nr. 2 & 4 der unteren Heizplatte treten gleichzeitig auf.</p> <p>6. Fehler Nr. 2 & 4 der oberen Heizplatte treten gleichzeitig auf.</p>	

 	<p>7. Fehler Nr. 1, 2 & 4 der unteren Heizplatte treten gleichzeitig auf.</p> <p>7. Fehler Nr. 1, 2 & 4 der oberen Heizplatte treten gleichzeitig auf.</p>	
 	<p>8. Fehler des unteren Temperaturfühler-Stromkreises</p> <p>8. Fehler des unteren Temperaturfühler-Stromkreises</p>	<p>Platine austauschen</p> <p>Platine austauschen</p>
 	<p>9. Fehler Nr. 1 & 8 der unteren Heizplatte treten gleichzeitig auf.</p> <p>9. Fehler Nr. 1 & 8 der oberen Heizplatte treten gleichzeitig auf.</p>	
 	<p>10. Fehler Nr. 2 & 8 der unteren Heizplatte treten gleichzeitig auf.</p> <p>10. Fehler Nr. 2 & 8 der oberen Heizplatte treten gleichzeitig auf.</p>	
 	<p>11. Fehler Nr.1, 2 & 8 der unteren Heizplatte treten gleichzeitig auf.</p> <p>11. Fehler Nr.1, 2 & 8 der oberen Heizplatte treten gleichzeitig auf.</p>	
 	<p>12. Fehler Nr.4 & 8 der unteren Heizplatte treten gleichzeitig auf.</p> <p>12. Fehler Nr.4 & 8 der oberen Heizplatte treten gleichzeitig auf.</p>	
 	<p>13. Fehler Nr.1, 4 & 8 der unteren Heizplatte treten gleichzeitig auf.</p> <p>13. Fehler Nr.1, 4 & 8 der oberen Heizplatte treten gleichzeitig auf.</p>	
 	<p>14. Fehler Nr.2, 4 & 8 der unteren Heizplatte treten gleichzeitig auf.</p> <p>14. Fehler Nr.2, 4 & 8 der oberen Heizplatte treten gleichzeitig auf.</p>	

SÍMBOLOS Y TÉRMINOS

- C - - A** Temperatura de tostadora graduada en Celcius
F - - A Temperatura de tostadora graduada en Fahrenheit
AL - Nivel de graduación de alarma 1-4



Botón de sonido: Se usa con los botones del cronómetro y temperatura para graduar el nivel de la alarma



Botón del cronómetro: Se usa para leer el tiempo en modalidad de marcha. Se usa además para fijar el tiempo en modalidad de programación.



Botón de temperatura: Se usa para leer en modalidad de marcha el punto establecido de temperatura y para graduar el punto de temperatura en modalidad de programación.



Flecha ascendente: Se usa para fijar la hora, el sonido y la temperatura en modalidad de programación.



Flecha descendente: Se usa para fijar la hora, el sonido y la temperatura en modalidad de programación.

PROGRAMACIÓN DE FÁBRICA

Las tostadora con Visualizador Digital de Estado Sólido de Prince Castle vienen programadas de fábrica.

Si el tiempo de tostado ha sido fijado en 35 segundos, la temperatura en el modelo de su tostadora ha sido graduada y calibrada a 215°C.

Si el tiempo de tostado ha sido fijado en 55 segundos, la temperatura en el modelo de su tostadora ha sido graduada y calibrada a 204°C.

INSTALACIÓN

1. Examine la placa sobre la caja de control para verificar el voltaje correcto de funcionamiento. Conecte la tostadora en un enchufe con conexión a tierra para el voltaje indicado en la placa. Coloque el interruptor en posición ON (encendido) y deje calentar la tostadora durante 30 minutos hasta que alcance la temperatura de funcionamiento adecuada.
2. La tostadora ha sido programada en fábrica para indicar temperaturas en grados Celsius. Al encenderse la tostadora, aparecerá en el visualizador digital de la caja de control la leyenda **C - - A**, lo que representa grados Celsius y la "A" comenzará un conteo regresivo de 9 segundos. Podrá cambiar la lectura de temperatura de Celsius a Farenheit durante el conteo regresivo. Para el efecto, presione el botón de temperatura por un espacio de seis segundos. Véase la figura 1.

figura 1

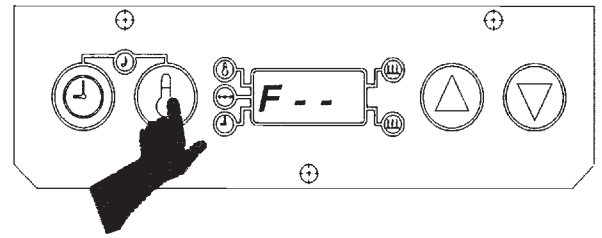

3. Durante el ciclo de precalentamiento, aparecerá en el visualizador la leyenda **L O -**. Al alcanzar el rodillo una temperatura de 149°C (300°F), aparecerá en el visualizador, durante el ciclo de tostado, las temperaturas reales del rodillo. Véase la figura 2.

figura 2

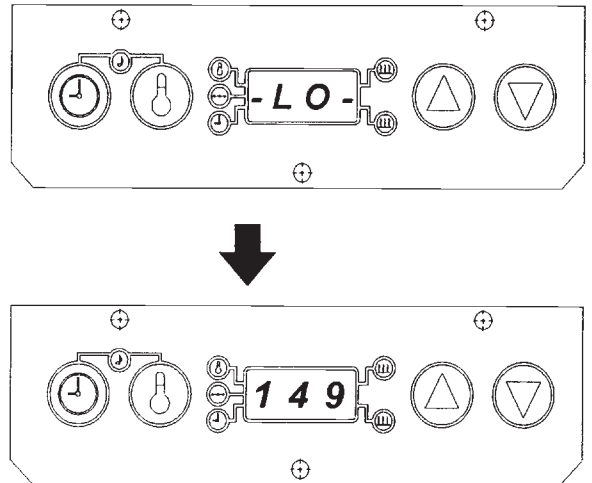

Para graduar el nivel de sonido



El audio de la alarma puede graduarse en cuatro niveles de sonido.

1. Para leer en el visualizador el nivel de sonido predeterminado, presione y sujete simultáneamente los botones del cronómetro y temperatura. Las tostadoras vienen programadas de fábrica en el nivel 4. En el visualizador aparecerá la leyenda **AL 4** que representa el Nivel de Alarma 4. Véase la figura 3.

figura 3

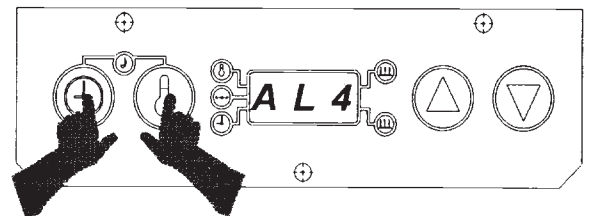

- Para graduar el nivel de sonido, presione el botón de la flecha ascendente o descendente mientras sujeta los botones del cronómetro y temperatura. Se escuchará una señal continua. Suelte todos los botones una vez graduado el sonido en el nivel deseado. En el visualizador aparecerá el nivel de sonido actual. Véase la figura 4.

figura 4

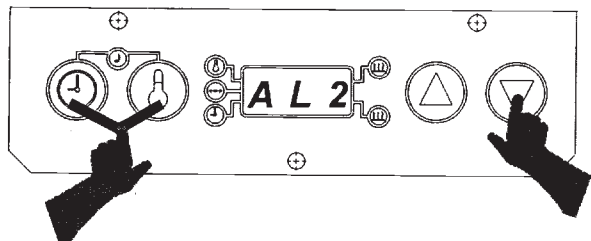

PARA LEER EL PUNTO ESTABLECIDO DE TEMPERATURA

- Presione y suelte el botón de temperatura. (No presione durante más de 6 segundos.) Se escuchará una señal, se activará el indicador de temperatura y en el visualizador aparecerá el punto de temperatura fijado durante tres segundos. El visualizador indicará luego la temperatura real. Véase la figura 5.

figura 5

PUNTO ESTABLECIDO DE TEMPERATURA

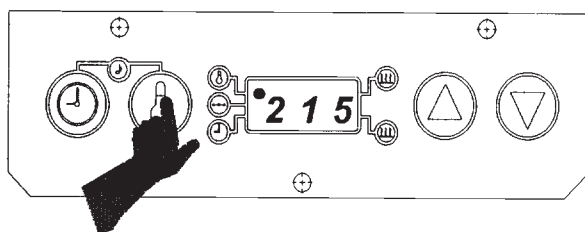

TEMPERATURA REAL



figura 6

TIEMPO ESTABLECIDO

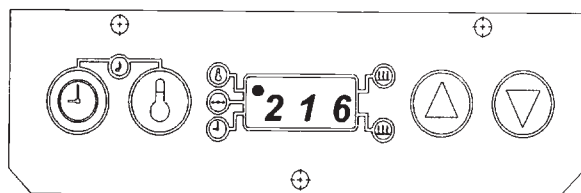
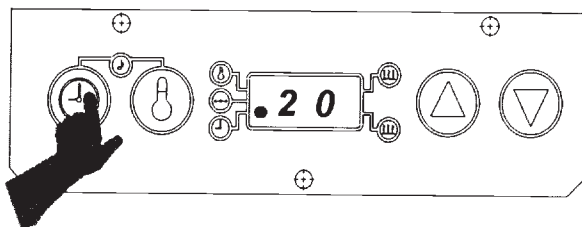

PROGRAMACIÓN

Las modalidades de programación se utilizan para graduar un punto de temperatura individual y fijar el tiempo de tostado.

Para programar el punto de temperatura predeterminado

- Presione y sujete el botón de temperatura por espacio de seis segundos. Se escuchará una señal, la luz del indicador de temperatura centelleará y en el visualizador aparecerá el punto de temperatura predeterminado. Véase la figura 7.

figura 7

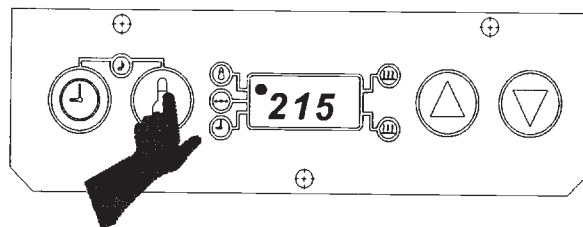

- Para cambiar el punto de temperatura predeterminado, utilice la flecha ascendente o descendente. Al indicar el visualizador la temperatura deseada, presione el botón de temperatura para almacenar la misma. Véase la figura 8.

figura 8

PARA CAMBIAR EL PUNTO DE TEMPERATURA PREDETERMINADO

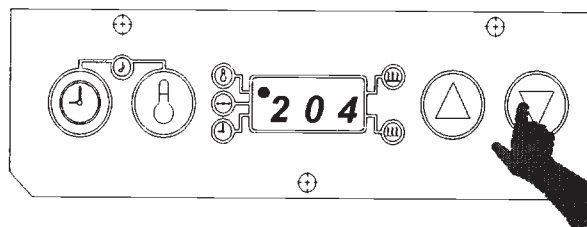

PARA ALMACENAR EL PUNTO DE TEMPERATURA

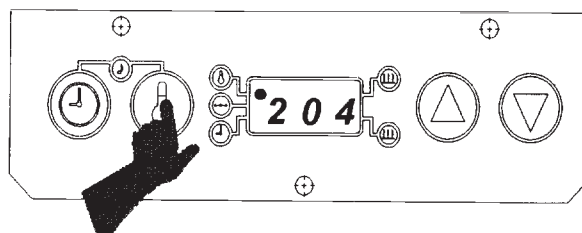

PARA LEER EL CON METRO

- Presione y suelte el botón del cronómetro. (No presione durante más de 6 segundos.) En el visualizador aparecerá el tiempo fijado durante tres segundos. Si el cronómetro ha sido activado y se encuentra en una secuencia de conteo regresivo, en el visualizador aparecerá el tiempo restante y el conteo continuará hasta llegar a cero. Después de tres segundos, aparecerá en el visualizador la temperatura actual del rodillo. Véase la figura 6.

3. Para desactivar la modalidad de programación en cualquier momento, presione y suelte el botón del cronómetro. En el visualizador aparecerá la temperatura real del rodillo. Véase la figura 9.

figura 9

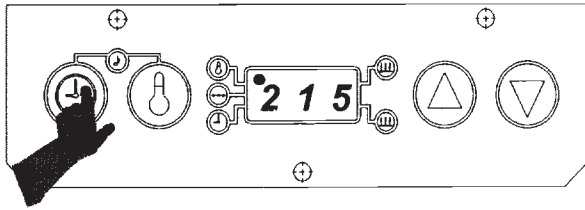

Para programar el tiempo de tostado

1. Presione y sujete el botón del cronómetro por espacio de seis segundos. Se escuchará una señal y la luz del indicador del cronómetro centelleará. Suelte el botón del cronómetro para leer el tiempo actual de tostado. Véase la figura 10.

figura 10

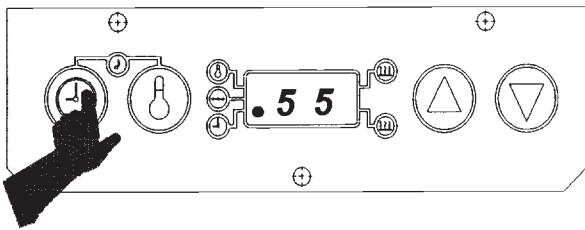

2. Para fijar el tiempo de tostado deseado, utilice la flecha ascendente o descendente. El margen es de 20 segundos a 1 minuto, 30 segundos. Al indicar el visualizador el tiempo deseado, presione y suelte el botón del cronómetro para almacenar el nuevo tiempo. Véase la figura 11.

figura 11

PARA FIJAR UN TIEMPO NUEVO

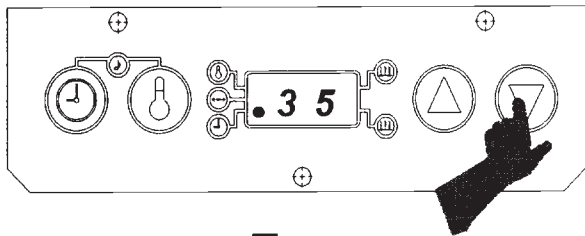

PARA ALMACENAR EL TIEMPO NUEVO

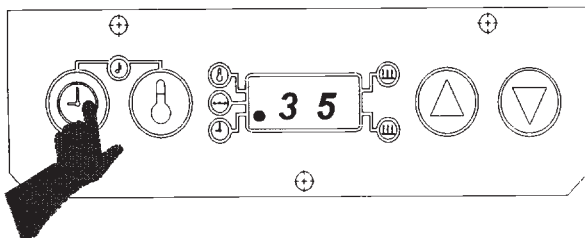

3. Para desactivar la modalidad de programación en cualquier momento, presione y suelte el botón de temperatura. La luz del indicador del cronómetro se apagará y en el visualizador aparecerá la temperatura real del rodillo. Véase la figura 12.

figura 12

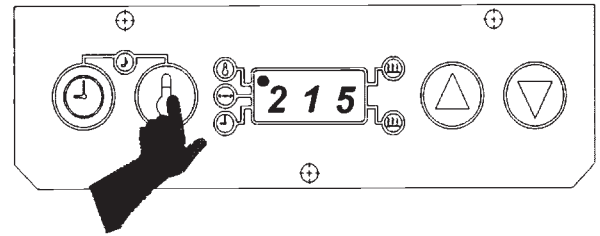

PARA AJUSTAR LOS BLOQUES DE DISTANCIA

Los bloques de distancia permiten que se aplique la compresión adecuada al tostarse los bollos. La tostadora viene de fábrica con los bloques de distancia programados en el número 3. Los bloques de distancia están ubicados en la parte frontal de la tostadora a ambos lados (derecho e izquierdo) de la base. Para aplicar mayor compresión, ajuste los bloques de distancia en el número 2. Para aplicar menor compresión, ajuste los bloques de distancia en el número 4. Véase la figura 13.

figura 13

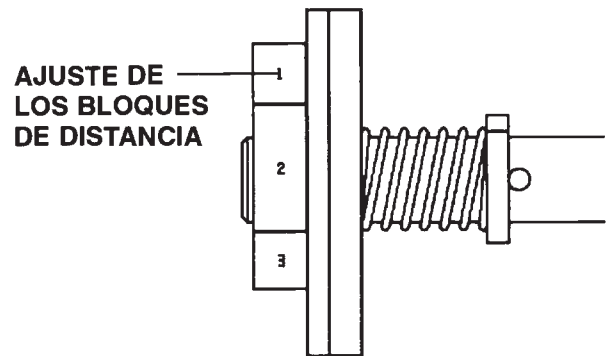

AJUSTE DE LOS BLOQUES DE DISTANCIA

IMPORTANTE: Los bloques de distancia se encuentran graduados en el número que toca la palanca. El ejemplo de la figura 13 muestra un bloque de distancia graduado en el número 1.

1. Para cambiar el ajuste de los bloques de distancia, baje el bloque de distancia derecho y desactive el pasador de seguridad. Gire el bloque de distancia al número deseado.

LIMPIEZA

1. Coloque el interruptor en la posición Off (apagado)
2. Desenchufe la tostadora.
3. Deje enfriar la tostadora y los rodillos.
4. Limpie el rodillo con un estropajo para parrilla limpio y húmedo. La limpieza total de la tostadora deberá realizarse en la mañana cuando la máquina está fría. Para más información sobre los métodos adecuados de limpieza, consulte la Tarjeta de plan de mantenimiento.





IMPORTANTE: No enrolle el cordón sobre la bandeja para bollos o el rodillo cuanto están calientes puesto que el cordón podría quemarse.

GU A PARA LA SOLUCIÓN DE PROBLEMAS

PROBLEMA	CAUSA	SOLUCIÓN
Rodillo suelto	Las tuercas del rodillo están sueltas.	Ajustar las tuercas del rodillo.
Se escucha sonido pero no se enciende la luz que indica que los bollos están listos.	La bombilla está quemada.	Cambiar la bombilla.
Se escucha sonido y se enciende la luz que indica que los bollos están listos.	Interruptor del cronómetro está defectuoso. Cortocircuito en la conexión del cronómetro en el conmutador de electricidad. El interruptor del cronómetro no se activa.	Cambiar el interruptor del cronómetro. Cambiar el conmutador de electricidad. Chequear el soporte de accionamiento para verificar si empuja el interruptor debidamente.
Los bollos se deshacen.	Los bloques de distancia no están ajustados adecuadamente. Las bandejas para bollos están combadas. Bollos mal cortados.	Ajustar los bloques de distancia. Enderezar o cambiar las bandejas para bollos. Comunicarse con la panadería.
No calienta el rodillo.	No pasa electricidad. Interruptor de alimentación defectuoso. Cortocircuito en el conmutador de electricidad. Cortocircuito en el rodillo o se quemó el rodillo.	Chequear la fuente de alimentación. Cambiar el interruptor de alimentación. Cambiar la fuente de electricidad. Chequear el rodillo con un ohmímetro para 11 ohmios, si la lectura es menor de 7 ohmios o mayor de 14 ohmios, cambiar el rodillo.
No funciona el visualizador.	Fusible defectuoso.	Chequear el fusible con un ohmímetro, la lectura debe estar entre los 1 y 2 ohmios.

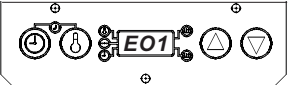
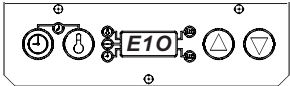
RESOLUCION DE PROBLEMAS DE DIAGNOSTICO

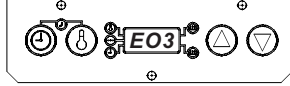
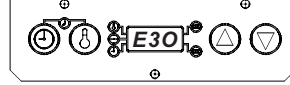
Si el tostador funciona mal, el visualizador mostrará un código de error (**E**) y un número del **1 al 9**, o una letra de la **A a la E**. Abajo aparecen diferentes códigos de errores y sus soluciones correspondientes. Por ejemplo, si el código de error es **E01**, esto significa que ha ocurrido una falla relacionada con los controles inferiores de la plancha. Si el código de error es **E10**, esto significa que ha ocurrido una falla relacionada con los controles superiores de la plancha.

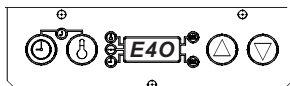
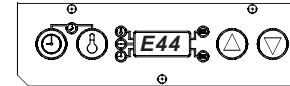
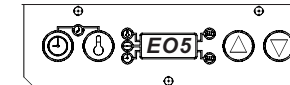
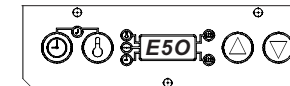
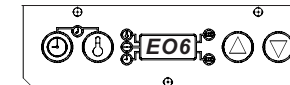
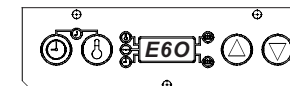
Diagnóstico	Problema	Solución
 	<p>1. Cortocircuito en los contactos de relé inferiores. Sobrecalentamiento de la plancha inferior.</p> <p>1. Cortocircuito en los contactos de relé superiores. Sobrecalentamiento de la plancha superior.</p>	<p>Reemplace el relé inferior. Reemplace el tablero de P.C.</p> <p>Reemplace el relé superior. Reemplace el tablero de P.C.</p>
 	<p>2. Sonda inferior abierta.</p> <p>2. Sonda superior abierta.</p>	<p>Reemplace la sonda inferior.</p> <p>Reemplace la sonda superior.</p>
 	<p>3. Fallas inferiores 1 y 2 combinados.</p> <p>3. Fallas superiores 1 y 2 combinados.</p>	
 	<p>4. Calentamiento insuficiente de la plancha inferior.</p> <p>4. Calentamiento insuficiente de la plancha superior.</p>	<p>Reemplace el relé inferior. Revise la resistencia de la plancha inferior. Reemplace el tablero de P.C.</p> <p>Reemplace el relé superior. Revise la resistencia de la plancha superior. Reemplace el tablero de P.C.</p>
	<p>Calentamiento insuficiente de ambas planchas.</p> <p>1. Revise si hay un flujo de aire frío en dirección del tostador.</p> <p>2. Se puede tostar una cantidad máxima de 900 grupos de bollos en 1 hora. El tostador puede experimentar una falla de tipo E44 si se excede esta cantidad. Si esto ocurre, deje de usar el tostador durante 3 minutos para corregir la falla. Después, puede volver a usar el tostador. Si lo anterior no ocurre, reemplace el tablero de P.C.</p>	
 	<p>5. Fallas inferiores 1 y 4 combinados.</p> <p>5. Fallas superiores 1 y 4 combinados.</p>	
 	<p>6. Fallas inferiores 2 y 4 combinados.</p> <p>6. Fallas superiores 2 y 4 combinados.</p>	

	<p>7. Fallas inferiores 1, 2 y 4 combinados.</p> <p>7. Fallas superiores 1, 2 y 4 combinados.</p>	
	<p>8. Falla del circuito de sondeo inferior</p> <p>8. Falla del circuito de sondeo superior.</p>	<p>Reemplace el tablero de P.C.</p> <p>Reemplace el tablero de P.C.</p>
	<p>9. Fallas inferiores 1 y 8 combinados.</p> <p>9. Fallas superiores 1 y 8 combinados.</p>	
	<p>10. Fallas inferiores 2 y 8 combinados.</p> <p>10. Fallas superiores 2 y 8 combinados.</p>	
	<p>11. Fallas inferiores 1, 2 y 8 combinados.</p> <p>11. Fallas superiores 1, 2 y 8 combinados.</p>	
	<p>12. Fallas inferiores 4 y 8 combinados.</p> <p>12. Fallas superiores 4 y 8 combinados.</p>	
	<p>13. Fallas inferiores 1, 4 y 8 combinados.</p> <p>13. Fallas superiores 1, 4 y 8 combinados.</p>	
	<p>14. Fallas inferiores 2, 4 y 8 combinados.</p> <p>14. Fallas superiores 2, 4 y 8 combinados.</p>	

SIMBOLI E TERMINOLOGIA

C -- A Il tostapane è impostato in gradi Centigradi.

F -- A Il tostapane è impostato in gradi Fahrenheit.

AL - Impostazione Livello dell'Allarme 1-4.



Pulsante del segnale acustico: da usare con i pulsanti timer e temperatura per impostare il livello dell'allarme.



Pulsante timer: da usare per vedere il tempo in modalità "run" (in funzione). Da usare per impostare il tempo in modalità di programmazione.



Pulsante temperatura: da usare per vedere la temperatura impostata in modalità "run" (in funzione) e da usare per impostare la temperatura in modalità di programmazione.



Freccia sù: da usare per impostare tempo, suono e temperatura in modalità di programmazione.



Freccia giù: da usare per impostare tempo, suono e temperatura in modalità di programmazione.

PREIMPOSTAZIONE DI FABBRICA

I Quadranti Digitali a Stato Solido dei tostapane della Prince Castle sono preimpostati in fabbrica.

Se il Vostro modello di tostapane è impostato per un un tempo di tostatura di 35 secondi, la temperatura è preimpostata e calibrata a 215°C.

Se il Vostro modello di tostapane è impostato per un tempo di tostatura di 55 secondi, la temperatura è preimpostata e calibrata a 204°C.

APPONTAMENTO

1. Per il corretto voltaggio, fate riferimento all'etichetta sulla scatola dei comandi. Collegare il tostapane ad una presa di corrente con messa a terra dal voltaggio richiesto. Spostate l'interruttore nella posizione "ON" e lasciate che l'unità si riscaldi per 30 minuti fino ad arrivare alla temperatura d'uso.
2. Il tostapane è impostato in fabbrica a visualizzare la temperatura in gradi Centigradi. Quando accendete il tostapane, il quadrante digitale sulla scatola dei comandi visualizza C-- A per Centigradi e la "A" comincia un conto alla rovescia di 9 secondi. Durante questo conto alla rovescia, potete modificare la lettura della temperatura nel quadrante da Centigradi a Fahrenheit tenendo premuto il pulsante temperatura per 6 secondi. Vedi figura 1.

figura 1

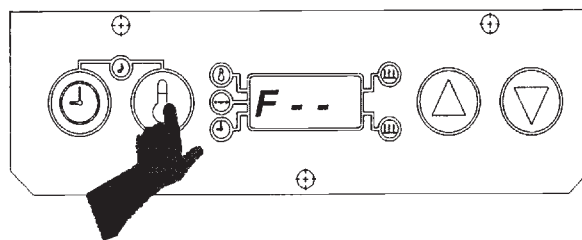

3. Durante il ciclo di riscaldamento sul quadrante si vede **LO**-. Una volta che la temperatura della piastra raggiunge i 149°C. (300°F.), il quadrante comincerà a visualizzare la reale temperatura della piastra per tutti i cicli di tostatura. Vedi figura 2.

figura 2

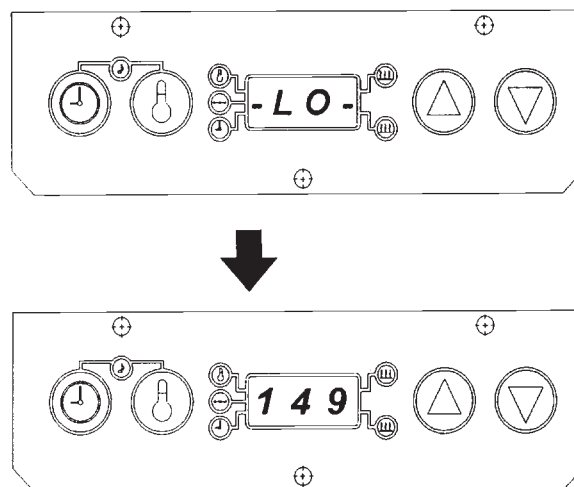

Regolazione livello sonoro.



L'allarme sonoro ha tre livelli di suono.

1. Tenete premuti simultaneamente i pulsanti tempo e temperatura. Sul quadrante si vede l'attuale livello di suono. I tostapane sono impostati alla fabbrica al livello di suono 4 e, sul quadrante, si dovrebbe leggere **AL 4** che significa **Allarme Livello 4**. Vedi figura 3.

figura 3

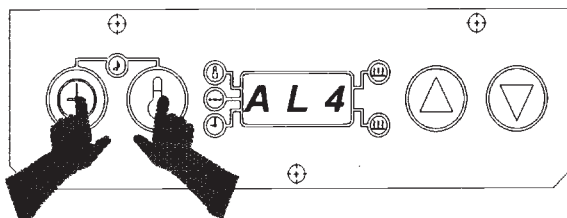

2. Tenendo premuti i pulsanti tempo e temperatura, premete i pulsanti "freccia sù" o "freccia giù" per regolare il livello del suono. Sentirete un segnale acustico continuo. Una volta raggiunto il livello sonoro desiderato, lasciate andare i pulsanti. Sul quadrante si leggerà l'attuale livello sonoro. Vedi figura 4.

figura 4

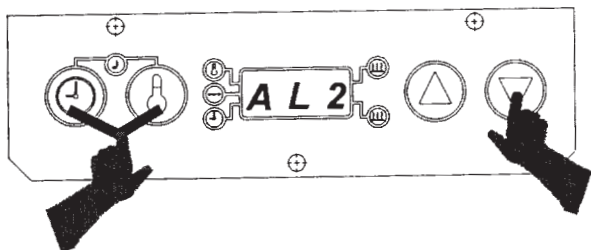

VISUALIZZAZIONE DEL PUNTO DI TEMPERATURA IMPOSTATO

1. Premete e rilasciate il pulsante della temperatura. (Non tenetelo premuto per più di 6 secondi). Al segnale acustico si accenderà l'indicatore della temperatura e, sul quadrante, sarà possibile leggere, per tre secondi, la temperatura impostata. Dopo i tre secondi, sul quadrante apparirà la temperatura reale. Vedi figura 5.

figura 5

PUNTO DI TEMPERATURA IMPOSTATO

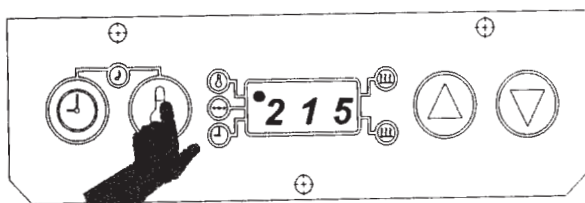

TEMPERATURA REALE

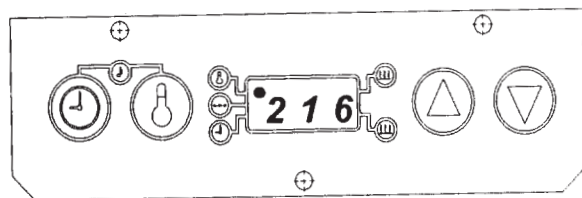

VISUALIZZAZIONE IMPOSTAZIONE DEL TIMER

1. Premete e rilasciate il pulsante tempo. (Non tenetelo premuto per più di 6 secondi.). Il tempo impostato sarà visualizzato per tre secondi. Se il timer è attivato e sta effettuando un conto alla rovescia, sul quadrante si vedrà il tempo mancante e il conto alla rovescia continuerà fino allo zero. Dopo tre secondi, sul quadrante ritornerà la reale temperatura della piastra. Vedi figura 6.

figura 6

TEMPO IMPOSTATO

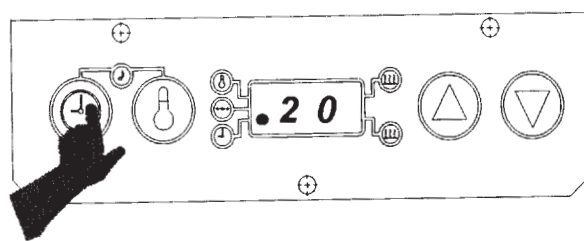

PROGRAMMAZIONE

Le modalità di programmazione sono usate per impostare individuali temperature e tempi di tostatura.

Programmazione del punto di temperatura impostato

1. Premete e tenete premuto il pulsante temperatura per sei secondi. Al segnale acustico, la luce dell'indicatore della temperatura lampeggerà e sul quadrante si leggerà l'attuale punto di temperatura. Vedi figura 7.

figura 7

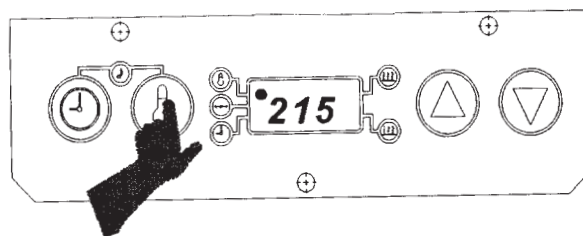

2. Per cambiare il punto di temperatura impostato, usate le frecce sù e giù. Quando sul quadrante si legge la temperatura desiderata, premete il pulsante temperatura per fissare la nuova regolazione. Vedi figura 8.

figura 8

REGOLAZIONE DEL PUNTO DI TEMPERATURA IMPOSTATO

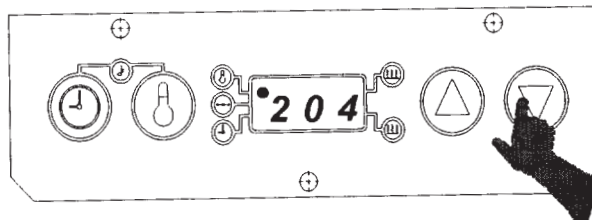

FISSAGGIO DEL PUNTO DI TEMPERATURA IMPOSTATO

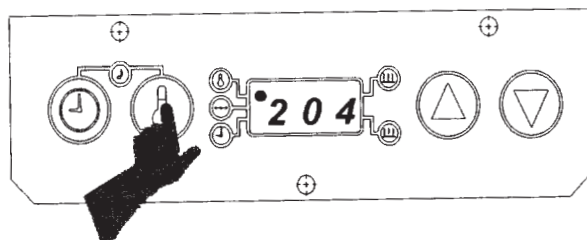

- È possibile uscire dalla modalità di programmazione in ogni momento semplicemente premendo e rilasciando il pulsante tempo. Sul quadrante apparirà, allora, la reale temperatura della piastra. Vedi figura 9.

figura 9

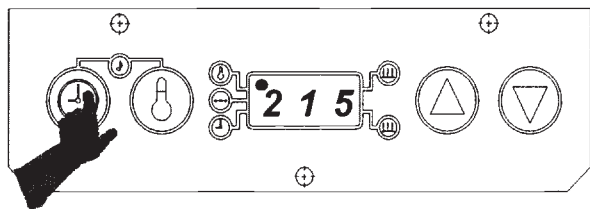

Programmazione tempi di tostatura

1. Premete e tenete premuto il pulsante tempo per 6 secondi. Al segnale acustico, la luce dell'indicatore del tempo comincerà a lampeggiare. Rilasciate il pulsante per vedere l'attuale tempo di tostatura. Vedi figura 10.

figura 10

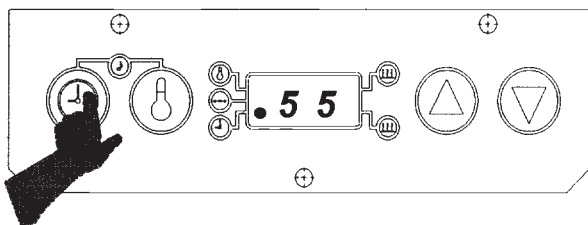

2. Usando le frecce sù e giù, regolate il tempo di tostatura come desiderato entro il raggio tra 20 secondi a 1 minuto e 30 secondi. Una volta raggiunto il tempo desiderato, premete e rilasciate il pulsante tempo per fissare il nuovo tempo di tostatura. Vedi figura 11.

figura 11

REGOLAZIONE DEL NUOVO TEMPO

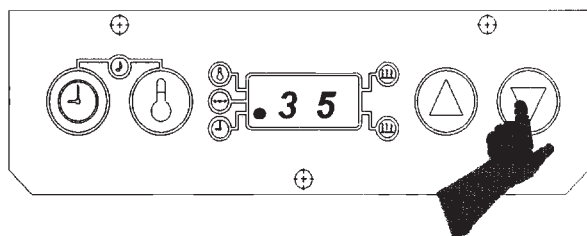

FISSAGGIO DEL NUOVO TEMPO

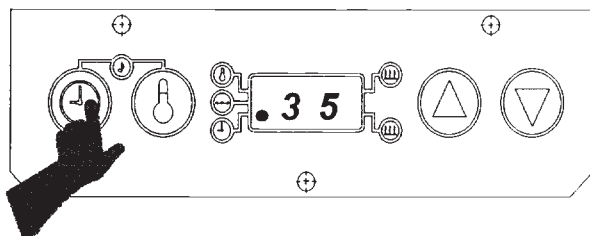

- È possibile uscire dalla regolazione in ogni momento semplicemente premendo e rilasciando il pulsante temperatura. La luce dell'indicatore del tempo si spegnerà e sul quadrante apparirà l'attuale temperatura della piastra. Vedi figura 12.

figura 12

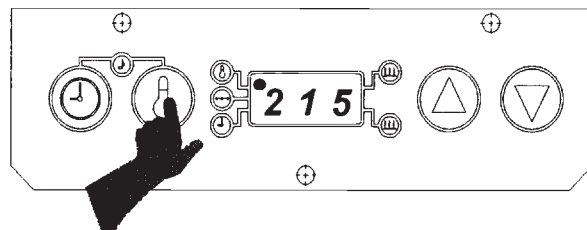

REGOLAZIONE DEI BLOCCHI D'ARRESTO

I blocchi d'arresto permettono di esercitare la giusta pressione sui panini durante la tostatura. Il tostapane lascia la fabbrica con i blocchi d'arresto regolati sulla posizione 3. I blocchi d'arresto si trovano verso la parte anteriore, a destra e a sinistra, della base del tostapane. Per aumentare la pressione, regolate i blocchi d'arresto sulla posizione 2. Per diminuirla, regolate i blocchi d'arresto sulla posizione 4. Vedi figura 13.

figura 13

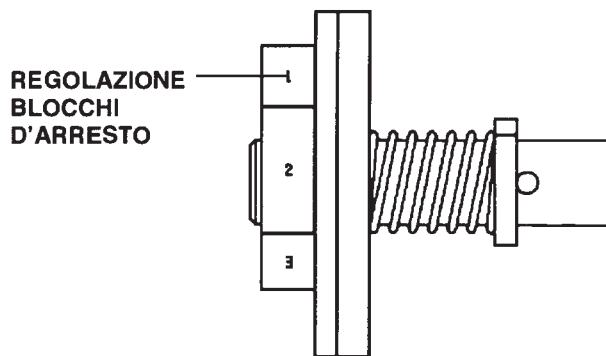

NOTA BENE: la regolazione dei blocchi d'arresto è quella del numero toccato dalla levetta. L'esempio in figura 13 illustra i blocchi d'arresto in posizione 1.

1. Per modificare la regolazione dei blocchi d'arresto, rilasciate il blocco d'arresto a destra e disinnestate il perno di bloccaggio. Girate poi il blocco d'arresto per la regolazione voluta.

PULIZIA

1. Premete l'interruttore e mettetelo in posizione "off".
2. Scollegate il tostapane.
3. Lasciate che il tostapane e le piastre si raffreddino.
4. Strofinare l'intera piastra con un panno da griglia umido e pulito. La pulizia completa del tostapane deve essere eseguita alla mattina quando il tostapane è freddo. Consultate la Vostra *Scheda Manutenzione Ordinaria* per le corrette procedure di pulizia.



NOTA BENE: per evitare che si bruci, non mettete la spina sopra la piastra o il piatto dei panini quando sono caldi.

GUIDA LOCALIZZAZIONE GUASTI

PROBLEMA	CAUSA	SOLUZIONE
Piastra allentata.	Bulloni della piastra allentati.	Serrare i bulloni della piastra.
Il segnalatore acustico funziona, l'indicatore luminoso "Bun Ready" no.	Lampadina bruciata.	Sostituire la lampadina.
Segnalatore acustico e indicatore luminoso "Bun Ready" non funzionanti.	Interruttore del timer difettoso. I collegamenti del timer sulla scheda a circuiti sono cortocircuitati Interruttore del timer non funzionante.	Sostituire l'interruttore del timer. Sostituire la scheda a circuiti stampati Controllare che la staffa di azionamento faccia pressione sull'interruttore del timer premendolo completamente
I panini vengono schiacciati.	Blocchi d'arresto non regolati correttamente. Vassoi dei panini contorti. Panini tagliati scorrettamente. Manca la corrente.	Regolare i blocchi d'arresto. Raddrizzare o sostituire i vassoi. Contattare la forneria.
La piastra non riscalda.	Interruttore difettoso. Scheda a circuiti cortocircuitata Piastra bruciata o cortocircuitata.	Controllare la fonte di corrente. Sostituire l'interruttore. Sostituire la scheda a circuiti Controllare la piastra, con un ohmmetro, che la piastra misuri 11 ohm. Se la lettura è meno di 7 ohm o più di 14 ohm, sostituire la piastra.
Quadrante spento.	Fusibile difettoso.	Controllate il fusibile con l'ohmmetro: la lettura dovrebbe essere di 1-2 ohm.

GUIDA LOCALIZZAZIONE GUASTI

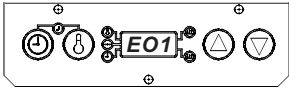
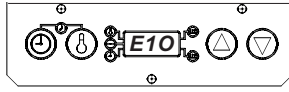
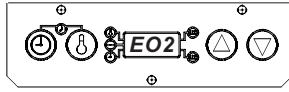
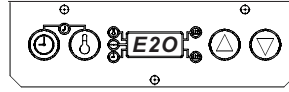
In caso di cattivo funzionamento del tostapane, appariranno sul quadrante il codice errore **E** ed un numero compreso tra **1 e 9**, o una lettera compresa tra **A e E**. Segue un elenco dei codici errore e della loro soluzione. Per esempio, se il codice errore è **E01**, c'è un guasto alla piastra inferiore. Se il codice errore è **E10**, c'è un guasto alla piastra superiore.

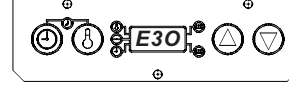
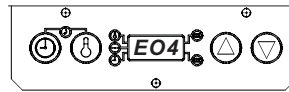
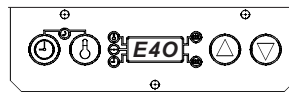
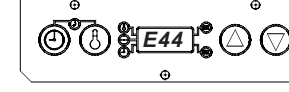
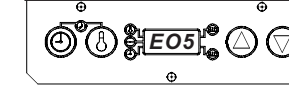
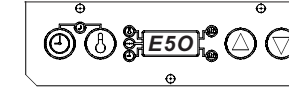
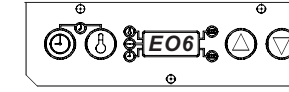
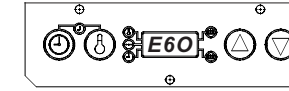
Diagnostica	Problema	Soluzione
 	<p>1. Contatti relé della piastra inferiore cortocircuitati. Surriscaldamento della piastra inferiore.</p> <p>1. Contatti relé della piastra superiore cortocircuitati. Surriscaldamento della piastra inferiore.</p>	<p>Sostituire il relé inferiore Sostituire la Scheda P.C.</p> <p>Sostituire il relé superiore Sostituire la Scheda P.C.</p>
 	<p>2. Sonda inferiore aperta</p> <p>2. Sonda superiore aperta.</p>	<p>Sostituire la sonda inferiore.</p> <p>Sostituire la sonda superiore.</p>
 	<p>3. Combinazione di guasti 1 e 2, piastra inferiore.</p> <p>3. Combinazione di guasti 1 e 2, piastra superiore</p>	
 	<p>4. Sottoriscaldamento della piastra inferiore.</p> <p>4. Sottoriscaldamento della piastra superiore.</p>	<p>Sostituire il relé inferiore. Controllare la resistenza della piastra inferiore. Sostituire la Scheda P.C.</p> <p>Sostituire il relé superiore. Controllare la resistenza della piastra superiore. Sostituire la Scheda P.C.</p>
	<p>Sottoriscaldamento di entrambe le piastre.</p> <p>2. Il numero massimo di panini che è possibile tostare in un ora è 900; superato detto numero, il tostapane potrebbe fermarsi e potrebbe apparire il codice errore E44. Per risolvere tale problema, sospendere l'uso del tostapane per 3 minuti. Se dopo tre minuti il tostapane non funzionasse, sostituire la Scheda P.C.</p>	<p>1. Verificare che sul tostapane non ci sia un flusso di aria fredda.</p>
 	<p>5. Combinazione di guasti 1 e 4, piastra inferiore.</p> <p>5. Combinazione di guasti 1 e 4, piastra superiore.</p>	
 	<p>6. Combinazione di guasti 2 e 4, piastra inferiore.</p> <p>6. Combinazione di guasti 2 e 4, piastra superiore.</p>	

	<p>7. Combinazione di guasti 1, 2 e 4, piastra inferiore.</p> <p>7. Combinazione di guasti 1, 2 e 4, piastra superiore.</p>	
	<p>8. Guasto al circuito della sonda inferiore.</p> <p>8. Guasto al circuito della sonda superiore.</p>	<p>Sostituire la Scheda P.C.</p> <p>Sostituire la Scheda P.C.</p>
	<p>9. Combinazione di guasti 1 e 8, piastra inferiore.</p> <p>9. Combinazione di guasti 1 e 8, piastra superiore.</p>	
	<p>10. Combinazione di guasti 2 e 8, piastra inferiore.</p> <p>10. Combinazione di guasti 2 e 8, piastra superiore.</p>	
	<p>11. Combinazione di guasti 1, 2 e 8, piastra inferiore.</p> <p>11. Combinazione di guasti 1, 2 e 8, piastra superiore.</p>	
	<p>12. Combinazione di guasti 4 e 8, piastra inferiore.</p> <p>12. Combinazione di guasti 4 e 8, piastra superiore.</p>	
	<p>13. Combinazione di guasti 1, 4 e 8, piastra inferiore.</p> <p>13. Combinazione di guasti 1, 4 e 8, piastra superiore.</p>	
	<p>14. Combinazione di guasti 2, 4 e 8, piastra inferiore.</p> <p>14. Combinazione di guasti 2, 4 e 8, piastra superiore.</p>	

WIRING DIAGRAM

