

# OPERATING INSTRUCTIONS

PRINCE CASTLE INC. 

## Universal Toaster Model No. 411-SL Series

*Excalibur*



Prince Castle's Universal Batch Bun Toaster caramelizes up to 12 regular 4" (10.16 cm) buns at one time. Perfectly toasts two and three-part buns by allowing operators to adjust time and temperature selections. Constructed of durable stainless steel and aluminum, the 411-SL toaster features a self-diagnostic trouble shooting system and solid state controls and both audio and visual alarms. Two nickel-plated platens offer precise temperature control with superior and consistent toasting results. A stainless steel bun board makes bun removal easy.

### PRODUCT SPECIFICATION

#### Dimensions

|                |                   |
|----------------|-------------------|
| Height Open:   | 15" (38.1 cm)     |
| Height Closed: | 7" (17.7 cm)      |
| Width:         | 16-1/4" (41.2 cm) |
| Length Open:   | 35-1/4" (89.5 cm) |
| Length Closed: | 31-1/2" (80.0 cm) |

### TABLE OF CONTENTS

|                                       | PAGE |
|---------------------------------------|------|
| Installation .....                    | 2    |
| Operating .....                       | 4    |
| Troubleshooting .....                 | 5    |
| Self-Diagnostic Troubleshooting ..... | 6    |
| Non-scheduled Maintenance .....       | 7    |
| Parts List .....                      | 10   |
| Exploded View .....                   | 11   |
| Wiring Diagram .....                  | 12   |

### LIMITED WARRANTY

This product is warranted to be free from defects in material and/or workmanship for a period of two (2) year from date of original installation, not to exceed 30 months from date of shipment from our factory.

Any component which proves to be faulty in material and/or workmanship will be replaced or repaired (at the option of Prince Castle, Inc.) without cost to the customer for parts or labor.

This warranty is subject to the following exceptions/conditions:

- Use of non-genuine Prince Castle Parts voids this warranty.
- This equipment is portable; charges for on-location service (e.g., trip charges, mileage) are not included in the provisions of this warranty.
- All labor shall be performed during regular work hours. Overtime premium will be charged to the buyer.
- All problems due to operation at voltages other than specified on toaster nameplates.
- This product must be serviced by a Prince Castle Authorized Service Center or a Prince Castle Factory Service Technician. Failure to do so may void this warranty.
- Damage caused by carelessness, neglect, and/or abuse (e.g., dropping, tampering or altering parts), equipment damaged in shipment, by fire, flood or an act of God is not covered under this warranty.

355 East Kehoe Blvd. • Carol Stream, IL 60188

Tel: (630) 462-8800 • Fax: (630) 462-1460

Toll Free: 1-800-PCASTLE

## INSTALLATION

1. After you have removed the toaster from the carton, inspect the unit for signs of damage. If there is damage to the unit:
  - Notify carrier within 24 hours after delivery.
  - Save carton and packing materials for inspection purposes.
  - Contact the Prince Castle Customer Sales Department at 1-800-722-7853 to arrange for a replacement to be sent.
2. Verify that all parts have been received.
3. If you find a part missing call 1-800-722-7853 and ask for the Customer Sales Department. If you have a question with operation ask for the Service Department.
4. Toaster must be cold before Teflon release sheets can be installed.

**IMPORTANT:** Toaster must be locked in the open position by engaging the safety latch so toaster cannot be closed before installing the Teflon release sheet.

5. Install the stretcher bar (A) into the loop (B) of each release sheet (C). See figure 1.

figure 1

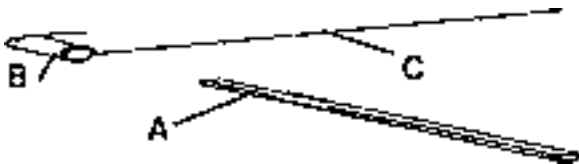

6. Slide release sheet (A) to rear of bottom platen (B) and attach to hooks (C). See figure 2.

figure 2

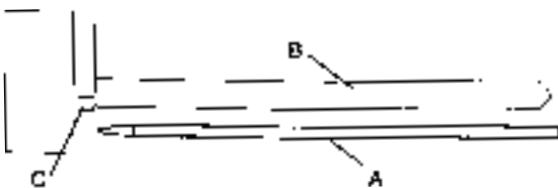

**IMPORTANT:** Slots in the stretcher bar are to face the front of the toaster.

7. Pull the release sheet tight against the bottom of the platen and spring retainer on the front of the platen.
8. Push round bar and release sheet into the spring retainer. See figure 3.

figure 3



**IMPORTANT:** The release sheet should be tight to the bottom of the platen. If not, remove round bar and repeat step 5.

9. Repeat steps 3-6 to install the release sheet on upper platen.

## OPERATION



**CAUTION:** Before plugging in, make sure toaster power switch is in the OFF position.

1. Insert the power cord into an ANSI 125/250 volt, 3 pole 4 wire grounding outlet. The receptacle should be a type NEMA #L14-20R. For European units the receptacle should be a MENNEKES #316 P6 1302.

**IMPORTANT:** This should be a dedicated outlet. No other equipment should be operating on this line (i.e. fryers, refrigerators, cash registers, etc.).

2. Place the power switch in the ON position. See figure 4.

figure 4

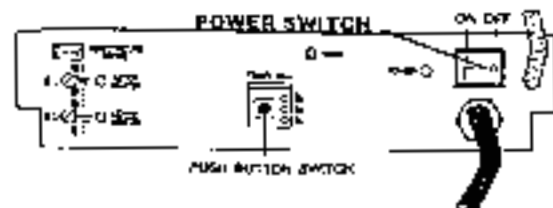

3. Platens must be in the "UP" position while the toaster warms up so that the timer is not activated. Warm-up takes 30 minutes. See figure 5.

figure 5

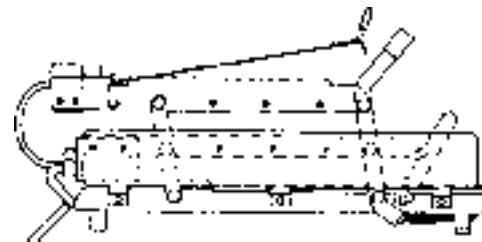

## SETTING TOAST TIMES (See figure 6.)

figure 6

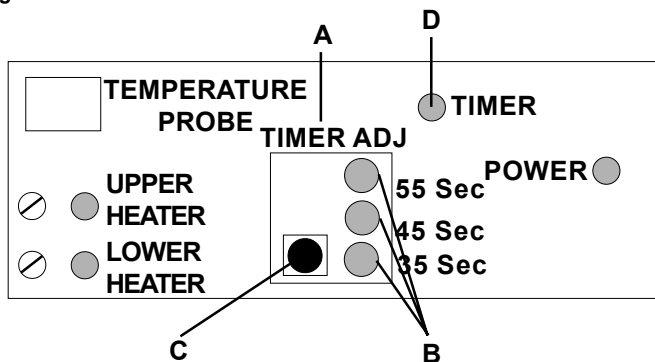

The toaster is preset at the factory for a 35 second toasting time and a 420° F toasting temperature on both platens. Temperature settings using commercial bakery buns are:

35 seconds 420° F  
 45 seconds 410° F  
 55 seconds 400° F

Settings may have to be adjusted because sugar within the product being toasted may vary from bakery to bakery.

1. On the lower control box panel, locate and lift the sliding door marked **TIMER ADJ** (A). Behind the door are three red LED's (B) each denoting a bun toasting time setting of either 35 sec, 45 sec or 55 sec.

**IMPORTANT:** There should be only one time setting light on.

2. Behind the **TIMER ADJ** (A) door there is a small **PUSH BUTTON SWITCH** (C). The bun toasting time can be set or changed whenever the toasting cycle is **NOT** active (i.e. when the red timer light (D) is not lit).
3. Press and hold the **TIMER ADJ** (A) button in for 5 seconds until an audio alarm sounds. At this point the next bun toasting time light will turn on. Release and press the **TIMER ADJ** (A) button until the desired bun toasting time for your product is selected.
4. Activate toaster timing cycle by pulling the handle/lever assembly forward and down. After selected time (35, 45, or 55 seconds) has elapsed the audible alert will sound and the "bun ready light" will come on.

## SETTING TOAST TEMPERATURES (See figure 7.)

(See figure 7.)

figure 7

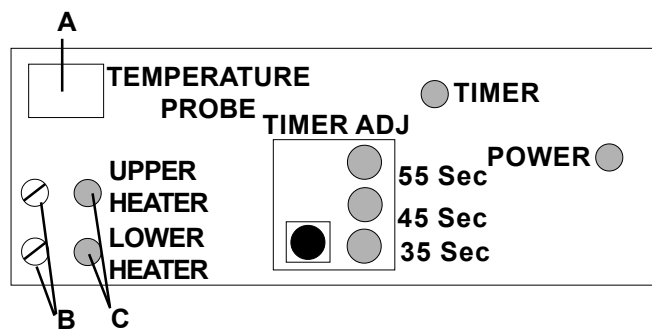

To properly calibrate and set cooking temperatures the following tools are required:

- ▣ "K" Type Pyrometer
- ▣ Thermo - Electric Patch Cord #SF001-250
- ▣ Flat Blade Screwdriver

1. Locate the two yellow-colored temperature probe jacks (A) on the upper and lower control boxes.
2. Plug one end of the Patch Cord into the temperature probe jack (A) of either the upper or lower control box depending on which platen you are calibrating first. Plug the other end of the patch cord into the "K" type pyrometer.
3. Directly beneath the temperature probe jack (A) on the lower control box are the two platen temperature control potentiometers (B), labeled upper adj and lower adj for upper platen and lower platen. Next to each temperature control potentiometer is a yellow indicating light (C) (upper header and lower heater). These indicating lights will be lit when power is being supplied to the corresponding platen. Thus these lights will cycle on/off as the corresponding platen temperature is being controlled.
4. To set a temperature use the flat blade screwdriver to turn the temperature control potentiometer (B). Turning the pot clockwise will increase the platen temperature counterclockwise to decrease.
5. Observe the potentiometers temperature display and note the temperature at the point when the Yellow heater indicator light (C) of the corresponding platen turns off. This temperature is considered the calibration temperature.

**IMPORTANT:** Toasting temperatures will vary by bread product so your calibrated temperature may vary for different products.

6. Remove the patch cord from the toaster temperature.

---

## SETTING STOP BLOCKS (See figures 8 & 9.)

The stop blocks allow toasting different sizes, cuts and brands of bread product. There are (6) combination stop block settings in  $\frac{1}{16}$ " increments. The overall range is  $\frac{3}{4}$ " to  $1\text{-}\frac{1}{4}$ ". The stop block settings allow a better crush when toasting different styles of buns.

1. Ensure stop blocks are on the correct setting before operating toaster. There are (6) stop block combinations available.
2. To change a stop block setting, depress the right stop block to disengage locking pin and turn in either direction to the desired setting.
3. View the stop block setting selected through the index window bracket which is located over each stop block. See figure 8.

figure 8

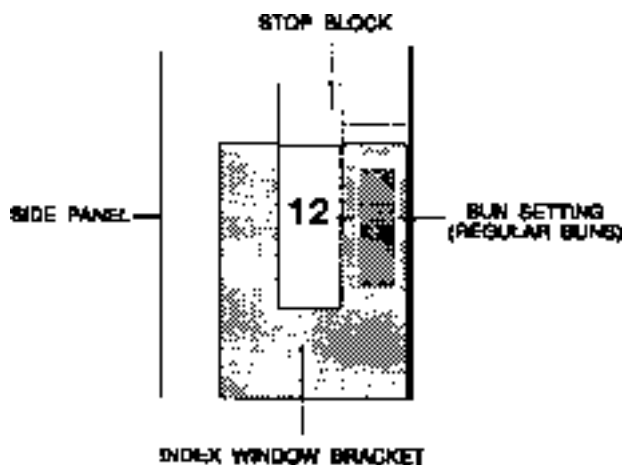

4. Locate the selector lever (A) on the front of the toaster frame and move the lever left or right to allow you to switch back and forth between the combination setting selected on the stop block. See figure 9.

figure 9

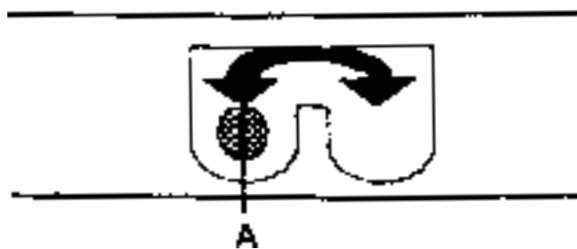

---

## CENTER OPENING ADJUSTMENT

To adjust the opening between the upper and lower platens, loosen the two screws holding the adjustment plate on each side of the lower platen. There are 11 adjustments. The middle adjustment is  $\frac{1}{2}$ ". Each adjustment moves the opening  $\frac{1}{16}$ ". Moving the adjustment plate to the left increases the opening, moving it to the right decreases the opening. The center adjustment should be used when toasting different cuts of bread.

---

## OPERATION

After selecting a cooking time and temperature, and setting the stop blocks and the center adjustment plate you are ready to begin toasting buns.

1. Using the bun spatula place the crowns face up.
2. Using the other bun spatula place the heels cut face down.
3. Lift the bun board on the upper platen up and insert the spatula with the heels on it.
4. Lower bun board down on top of heels and spatula slide spatula out leaving heels on platen with bun board on top.
5. Insert spatula with crowns on it into the center section or lower section of toaster.
6. Pull toaster handle forward to move platen on top of crowns, the timer will automatically activate and the red timer light will come on.
7. When the audio alarm sounds and the bun done light comes on, immediately push handle back to release crowns from platen. Remove spatula with crowns from toaster.
8. Lift bun board on upper platen and slide the spatula in under the heels and remove

## REMOVAL & CLEANING OF RELEASE SHEETS

### TO REMOVE:

1. Toaster must be cold before release sheets can be removed.



**CAUTION:** Before removing release sheets the toaster platen must be locked in its open position by engaging the “safety latch”.

2. Remove release sheets by removing the round bar from the spring clip on the front of platens and then remove the stretcher bar from rear hooks.
3. Remove stretcher bar from release sheets.

### TO CLEAN:

1. Lightly scrub the release sheet on both sides using a damp clean towel. Keep sheet flat while cleaning to ensure no wrinkles or creases are put into sheet.

**IMPORTANT:** Do not use green pads to scrub release sheets.

2. Rinse release sheets using clean running water and wipe the sheets dry in one direction only using a clean damp grill cloth until all residue is removed. Do not fold or crease (air dry).
3. Rinse release sheets using clean running water and wipe the sheets dry in one direction only using a clean damp grill cloth. Keep wiping until all residue is removed.

## CLEANING



**CAUTION:** Before unplugging power cord make sure the toaster power switch is turned OFF.

1. Unplug toaster power cord from outlet.
2. Allow toaster to cool.
3. Follow cleaning instructions.

**IMPORTANT:** Always lock platens in open position using the safety latch before cleaning or relocating toaster to a different location.

**IMPORTANT:** When cleaning do not pour water on the platen. This may cause an electrical hazard and cause serious damage to the sensitive solid state circuitry in this toaster.

## TROUBLESHOOTING CHART



**CAUTION:** Service is to be performed by qualified service personnel.



**CAUTION:** Use extreme caution during electrical circuit tests. Live circuits will be exposed.



**CAUTION:** Inspection, testing and repair of electrical equipment should be performed only by qualified service personnel. The unit should be unplugged when servicing, except when electrical tests are required.

| PROBLEM   | PROBABLE CAUSE  | CORRECTIVE ACTION                                       |
|---|---|---|
| Platen Has excessive movement.                    | Platen attachment bolts loose.                            | Tighten bolts.  |
| Audio Alarm works, no amber colored bun light.    | Light burned out.   | Replace amber colored bun done light.                   |
| No audio alarm or amber colored bun done light.   | Speaker defective.<br>Opto sensor board defective.        | Replace speaker.<br>Replace opto sensor board.          |
| Buns being crushed.                               | Stop blocks not adjusted properly<br>Buns cut improperly. | Adjust stop blocks.<br>Adjust stop block to (=) or (-). |
| Buns sticking to platen.                          | Excessive heat.<br>Built up caramelized sugar on platen.  | Calibrate toaster.<br>Clean platen (PM Card #17).       |
| One platen not heating but no diagnostic signals. | Corresponding probe inoperable.                           | Replace probe.  |

# SELF-DIAGNOSTIC TROUBLESHOOTING CHART

Observe the (3) red indicator lights (A), and the (2) yellow lights controlling the upper & lower heater area (B). An audio alarm will sound, match the lights in the malfunction section below to the toaster malfunction to identify the corrective action.

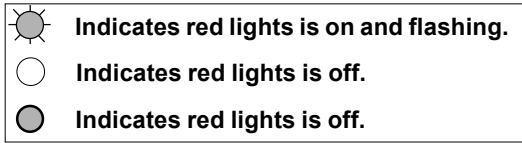

## LOWER CONTROL BOX FACEPLATE

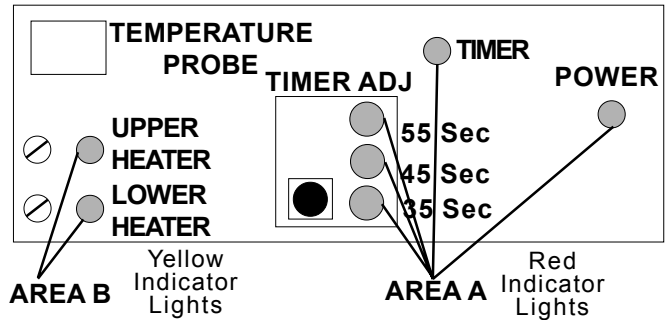

# SELF-DIAGNOSTIC TROUBLESHOOTING CHART

For the five malfunctions in this column, replace the 411-261S Power Board located in the lower control box.

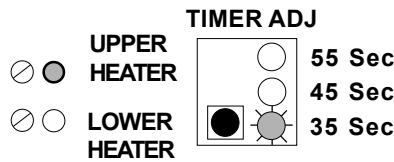

Check the lower probe connector at the main P.C. Board. Replace the 411-85S located in the lower control box.

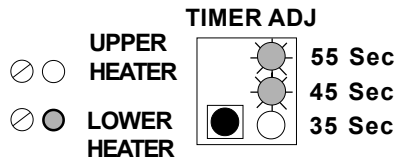
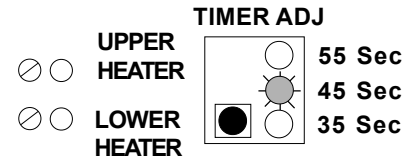

Check the upper probe connection at the opto-sensor board located in the upper control box. Replace the 411-85S located in the upper control box.

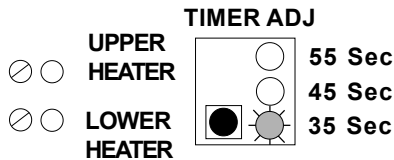
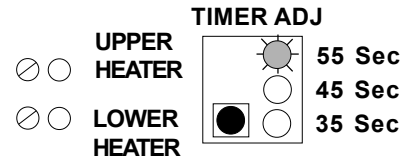

Replace the No. 411-262S Main P.C. board located on the front faceplate on the lower control box.

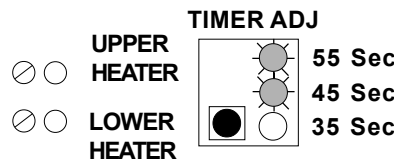
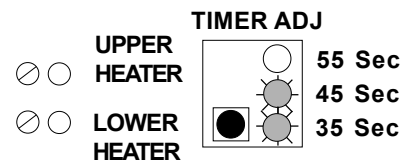

If there is no timer or heater lights on, but the audio alarm is sounding replace the [411-262S](#) Main P.C. Board.

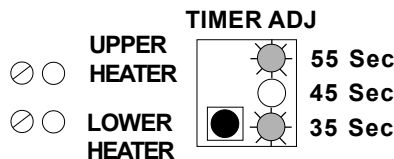
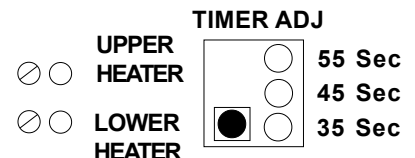

If (3) timer lights are flashing and an audio alarm is sounding the upper and lower platens are over heating. Turn the toaster OFF and disconnect the power cord from receptacle.

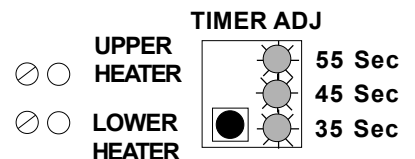

Then call the Prince Castle Service Department at 1-800-323-2930 for assistance.

# NON-SCHEDULED MAINTENANCE

## Model No. 411-14 Opto-Sensor P.C. Board

Tools Needed: 1/4" Flat blade screwdriver

1. With the toaster in the up position and the safety latch in place use the flat blade screwdriver to remove (7) screws (A) from the upper control box and slowly lift up the back. See figure 10.

figure 10

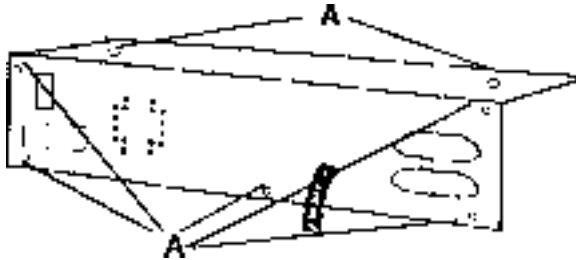

2. Disconnect the (4) wire connectors (A) from the P.C. Board (B). Using the flat blade screwdriver remove (4) screws (C) holding the P.C. Board to the standoffs (D) and carefully remove the P.C. Board. See figure 11.

figure 11

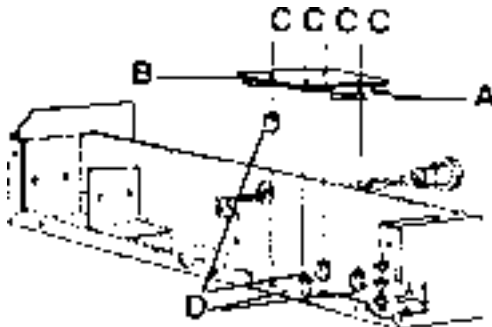

3. To install replacement Opto-Sensor P.C. Board reverse steps 1 and 2. When reconnecting the (4) wire connectors the RED connector goes into PROBE slot on board, the 3 prong white connector goes into the done light slot on the board, the 2 pronged white connector goes into the speaker slot on the board and the six prong maroon connector goes into the main P.C. Board slot on the board. Make sure all connections are tight. See figure 12.

figure 12

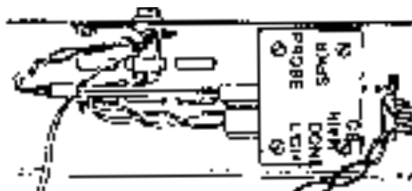

## Model No. 411-261S Power P.C. Board

Tools Needed: 1/4" Flat Blade Screwdriver

1. Disengage safety latch and lower toaster to toast position. Using 1/4" flat blade screw driver remove (2) screws (A) from cover (B) on the lower control box, and remove cover. See figure 13.

figure 13

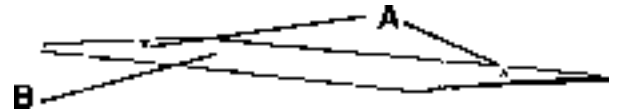

2. Carefully disconnect the wire connectors (A) from the board, using the 1/4" flat blade screwdriver remove the (3) wire connections (B) from the terminal block (C). See figure 14.

figure 14

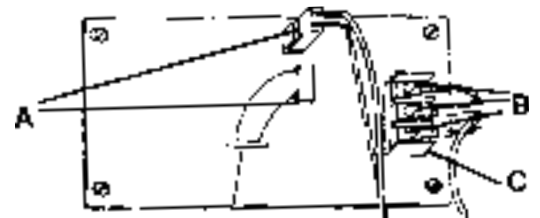

3. Using the 1/4" flat blade screwdriver remove the (2) screws and washers (A) that hold the power board to the standoffs from the top of the power board. Slide the P.C. Board out of the (2) rear mounting brackets (B) and lift out of the control box. See figure 15.

figure 15

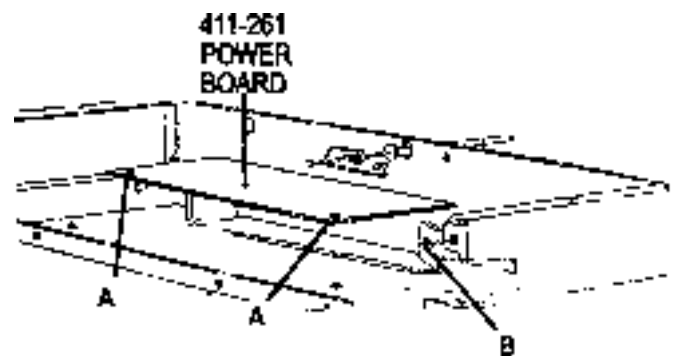

4. Reverse steps 1-3 to install the replacement board. Be sure all wire connections are tight and properly located.

## Model No. 411-262S Main P.C. Board

Tools Needed: 1/4" Flat Blade Screwdriver

1. Disengage safety latch and lower toaster to toast position. Using 1/4" flat blade screwdriver remove (2) screws (A) from cover (B) on lower control box, and remove cover. See figure 16.

figure 16

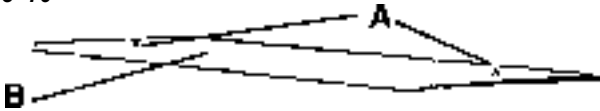

2. Using the 1/4" flat blade screwdriver remove (2) screws (A) from the front of the lower control box and carefully pull back faceplate exposing main P.C. Board. See figure 17.

figure 17

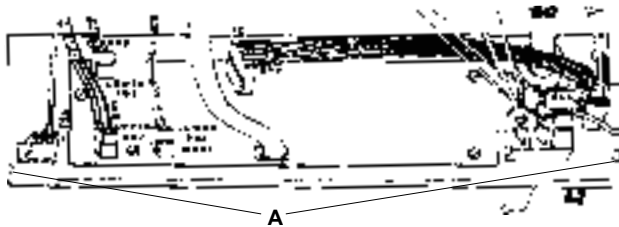

3. Disconnect the (5) wire connectors (A) from the board. See figure 18.

figure 18

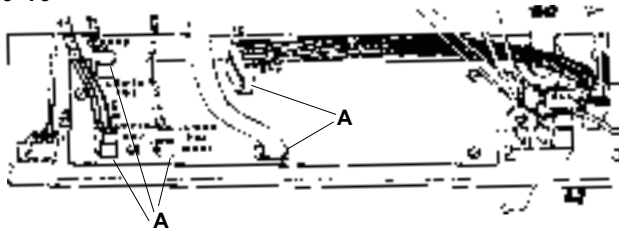

4. Using the 1/4" flat blade screwdriver remove the (5) screws (A) from the front of the faceplate which holds the board to the faceplate, and remove the old board. See figure 19.

figure 19

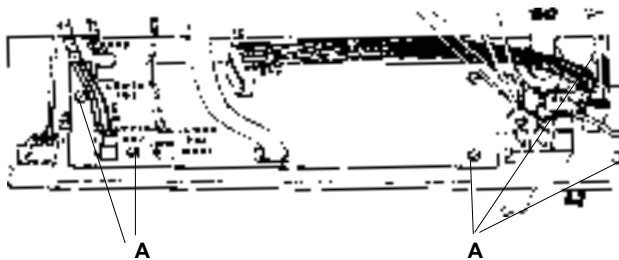

5. To install the new P.C. Board reverse steps 1-4. Make sure all wire connections are tight.

## Model No. 411-85S Probe Assembly

Tools Needed: 3/16" Flatblade Screwdriver  
1/4" Flatblade Screwdriver  
Nut Driver 8-32

1. Using the 1/4" flat blade screwdriver remove (7) screws (A) that secure the cover to the control box. See figure 20.

figure 20

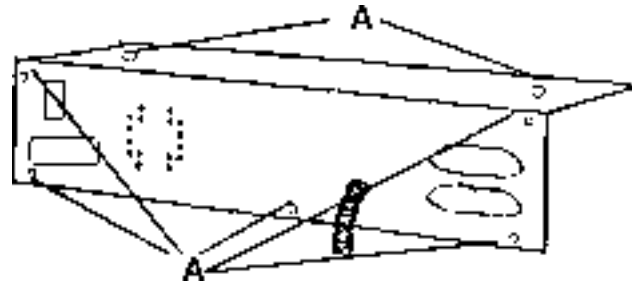

2. Using a 3/16" flatblade screwdriver loosen the (2) screws (A) that attach probe wires to the yellow mini-jack (B) and remove the (2) wires from this connection. See figure 21.

figure 21

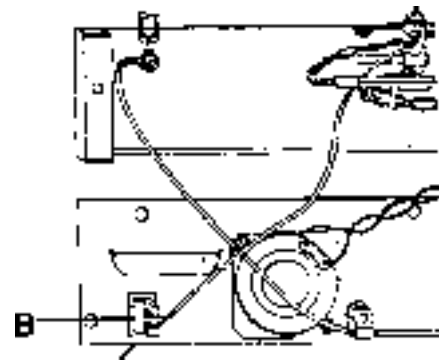

3. Unplug wire connector (A) from the probe (B) to the printed circuit board (C). See figure 22.

figure 22



- Using a nut driver remove nut (A) which secures probe bracket (B) to screw (C) on the control box. See figure 23.

figure 23

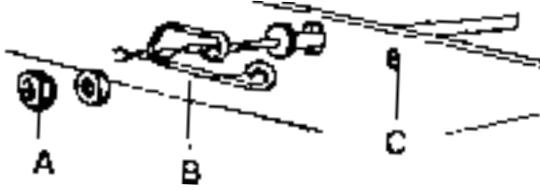

- Remove probe bracket (A) and carefully slide probe (B) out of the platen tube. Discard old probe assembly. See figure 24.

figure 24

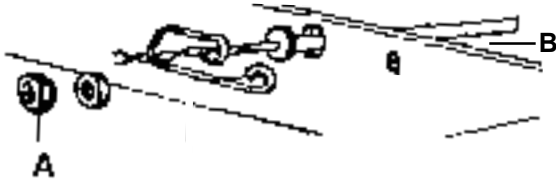

- Install new probe by reversing steps 2 through 5. For probe replacement in the lower control box follow these same instructions.

### Model No. 78-166S Power Switch

Tools needed: 1/4" Flat Blade Screwdriver.

- Lower toaster to toast position. Using 1/4" Flat Blade Screwdriver remove (2) screws (A) from the lower control box and lift off cover. See figure 25.

figure 25

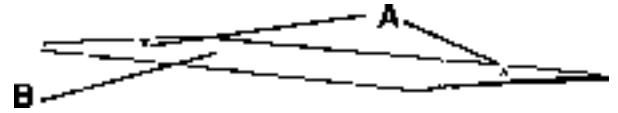

- Disconnect (4) wire connections (A) from the power switch (B). See figure 26.

figure 26

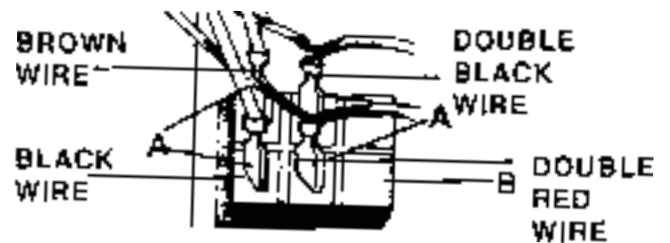

- Remove power switch by squeezing bezel clips on switch (A) and pushing switch (B) out of the control box. See figure 27.

figure 27



- To install new power switch reverse steps 1-3.

Make sure all wire connections are tight and on the right posts.

|              |   |                   |
|--------------|---|-------------------|
| Top Left     | = | Brown Wires       |
| Bottom Left  | = | Black Wire        |
| Top Right    | = | Double Black Wire |
| Bottom Right | = | Double Red Wire   |

## PARTS LIST

| ITEM | PART NO. | DESCRIPTION                   |    |         |  |
|------|----------|-------------------------------|----|---------|--|
| 1    | 411-2S   | Base                          | 62 | 88-573  | Cable Clamp  |
| 2    | 89-959S  | Rubber Foot                   | 63 | 89-921  | Nylon Spacer   |
| 3    | 411-243  | Rear Lever Assy.              | 65 | 411-72  | Upper Chassis Assy.  |
| 7    | 411-200  | Safety Latch                  | 66 | 411-74  | Upper Face Plate   |
| 8    | 411-238  | Front Lever Assy.             | 67 | 213-229 | Speaker Assy.  |
| 9    | 411-118  | Safety Latch Pin              | 68 | 482-18  | Speaker Grease Seal  |
| 10   | 411-8S   | Lower Platen                  | 69 | 411-14S | Sensor P.C. Board  |
|      | 411-26S  | Lower Platen (220 Volt)       | 70 | 213-257 | Done Light Assy.   |
| 11   | 411-42   | Lower Rear Bun Fence          | 71 | 411-140 | Insulator  |
| 12   | 411-44   | Lower Left Hand Bun Fence     | A  | 411-59  | Base Stud <sup>5</sup> / <sub>16</sub> -18                                   |
| 13   | 411-43   | Lower Right Hand Bun Fence    |    | 411-113 | Base Spacer  |
| 14   | 411-70   | Platen Tube                   |    | 73-167  | Self Locking Hex Nut <sup>5</sup> / <sub>16</sub> -18                        |
| 15   | 411-6S   | Upper Platen                  | B  | 411-60  | Lower Rear Platen Stud   |
|      | 411-24S  | Upper Platen (220 Volt)       |    | 411-57  | Lower Platen Spacer  |
| 16   | 411-254  | Upper Rear Bun Fence          | C  | 411-60  | Upper Platen Stud  |
| 17   | 411-234  | Upper Left Hand Bun Fence     |    | 411-241 | Safety latch Spacer  |
| 18   | 411-223  | Upper Right Hand Bun Fence    | D  | 411-60  | Upper Platen Stud  |
| 19   | 411-86   | Spring Rod                    |    | 411-221 | Upper Platen Spacer  |
| 20   | 81-013   | Extension Spring              | E  | 76-218  | Slotted Binder Head Screw <sup>1</sup> / <sub>4</sub> -20                    |
| 21   | 411-146  | Guide Rod (Shaft)             | F  | 411-60  | Lower Front Lever Platen Stud  |
| 22   | 411-108  | Lever Block                   |    | 411-57  | Upper Platen Spacer  |
| 23   | 89-925   | Plunger Spring                | H  | 76-179  | Slotted Binder Head Screw 10-18  |
| 24   | 411-107  | Lever                         | J  | 76-382  | Hex Head Screw <sup>1</sup> / <sub>4</sub> -20 x <sup>3</sup> / <sub>8</sub> |
| 25   | 411-117  | Cover Plate                   | K  | 76-343  | Set Screw 10-32 x <sup>3</sup> / <sub>4</sub>                                |
| 26   | 411-230  | Left Hand Stop Block          | L  | 68-039  | Roll Pin   |
| 27   | 411-231  | Right Hand Stop Block         | M  | 76-600  | Slotted Flat Head Screw 10-24 x 1  |
| 28   | 411-127  | Index Window                  |    | 73-008  | Self Lock Hex Nut 10-32  |
| 29   | 411-123  | Bun Tray Stop                 | N  | 76-040  | Slotted Binder Head Screw 10-32  |
| 30   | 411-256  | Right Side Panel Assy.        | P  | 76-043  | Slotted Binder Head Screw 8-32   |
| 31   | 411-41   | Strain Relief Bracket         | R  | 76-095  | Slotted Binder Head Screw 6-32   |
| 32   | 66-015   | Strain Relief Bushing         | S  | 76-095  | Slotted Binder Head Screw 6-32   |
| 33   | 72-126S  | Power Cord                    |    | 79-002  | Intl. Tooth Washer #6  |
| 34   | 411-257  | Left Side Panel Assy.         | T  | 76-044  | Slotted Binder Head Screw 8-32   |
| 40   | 411-77   | Lower Chassis                 |    | 73-021  | Hex Nut 8-32   |
| 41   | 411-80   | Lower Face Plate Assy.        | U  | 76-095  | Slotted Binder Head Screw 6-32   |
| 42   | 411-32   | Potentiometer Bracket         |    | 79-033  | Split Lock Washer #6   |
| 43   | 411-133S | Lower Potentiometer Assy.     |    | 73-031  | Self Locking Hex Nut   |
| 44   | 411-132S | Upper Potentiometer Assy.     | V  | 76-043  | Slotted Binder Head Screw 8-32   |
| 46   | 411-261S | Power P.C. Board              |    | 79-031  | Split Lock Washer #8   |
| 47   | 89-924   | Standoff                      |    | 73-021  | Hex Nut 8-32   |
| 48   | 77-058   | Barrier Strip                 | W  | 76-043  | Slotted Binder Head Screw 8-32   |
| 49   | 411-85S  | Probe Assy.                   |    | 79-143  | Flat Washer  |
| 50   | 213-166  | Probe Retainer                |    | 73-013  | Self Locking Hex Nut   |
| 51   | 411-31   | Chassis Cover                 | X  | 920-184 | Hex Nut  |
| 52   | 411-262S | Main P.C. Board               |    | 79-144  | Washer   |
| 53   | 88-497   | Mini-Jack                     | Y  | 76-043  | Slotted Binder Head Screw 8-32   |
| 54   | 71-117   | Clear Lens                    |    | 73-013  | Self Locking Hex Nut   |
| 55   | 78-166S  | Power Switch                  | AA | 76-043  | Slotted Binder Head Screw 8-32   |
| 56   | 411-69S  | Interconnect Cable            |    | 73-013  | Self Locking Hex Nut   |
|      | 411-109S | Interconnect Cable (220 Volt) | BB | 76-064  | Slotted Binder Head Screw 8-32   |
| 57   | 66-027   | Aluminum Strain Relief        |    | 73-021  | Hex Nut 8-32   |
|      | 66-062   | Strain Relief (220 Volt)      | CC | 76-043  | Slotted Binder Head Screw  |
| 58   | 411-83   | Cable Cord Bracket            |    | 73-021  | Hex Nut  |
| 59   | 89-938   | Loop Steel Clamp              | DD | 76-051  | Slotted Binder Head Screw 6-32   |
| 60   | 411-33   | Door Plate                    |    | 73-015  | Self Locking Hex Nut 6-32  |
| 61   | 411-34   | Door Guard                    | EE | 76-300  | Slotted Pan Head Screw   |
|      |          |                               | 72 | 411-233 | Upper Bracket  |

|    |         |                |
|----|---------|----------------|
| 73 | 411-234 | Upper Bracket  |
| 74 | 411-240 | Front Bracket  |
| 75 | 212-622 | Front Bracket  |
| 76 | 411-227 | Platen Bracket |

|    |         |                |
|----|---------|----------------|
| 77 | 411-228 | Platen Bracket |
| 78 | 411-239 | Front Bracket  |
| 79 | 411-242 | Teflon Holder  |
| 80 | 212-331 | Platen Plate   |

## EXPLODED VIEW

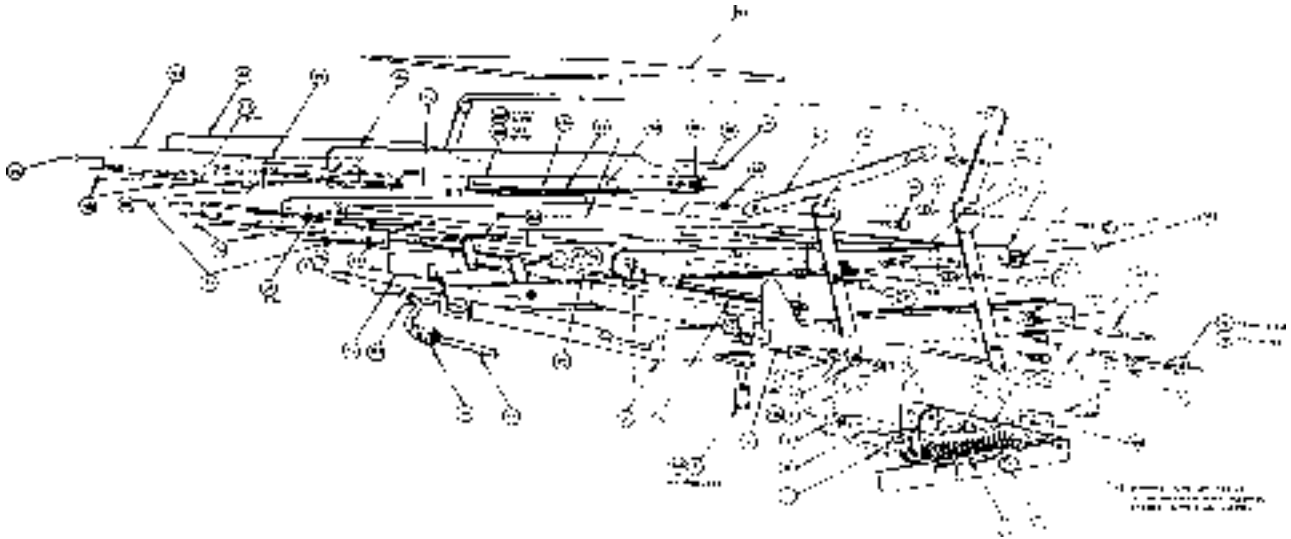

## UPPER CHASSIS ASSEMBLY

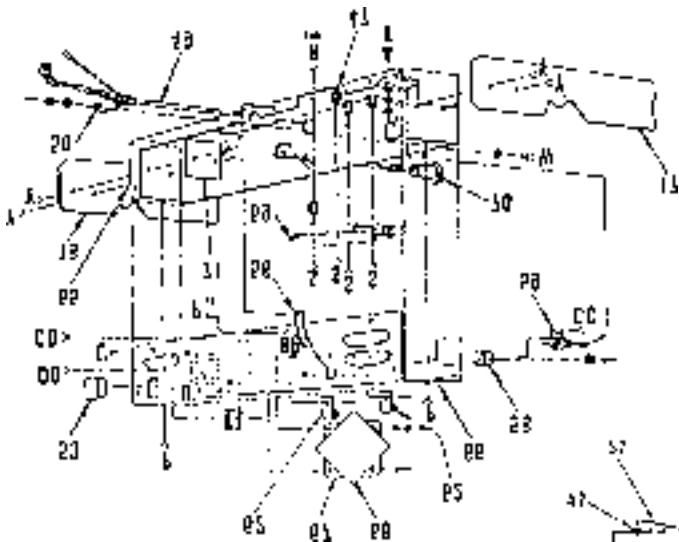

## LOWER CHASSIS ASSEMBLY

