

**SOLID STATE DIGITAL ENERGY SAVING TOASTER
PRINCE CASTLE MODEL NO. 416-S SERIES**



This equipment chapter is to be placed in the toasters section of your *Equipment Manual*.

**MANUFACTURED FOR
MCDONALD'S®
BY
PRINCE CASTLE INC.
355 KEHOE BLVD.
CAROL STREAM, IL. 60188 USA
PHONE 1-630-462-8800
TOLL FREE NUMBER
1-800-323-2930
FAX:1-630-462-1460**



WARRANTY	Page 1
SIDE VIEW	Page 2
FRONT VIEW	Page 3
REAR VIEW	Page 3
INTERNAL VIEW	Page 4
EQUIPMENT SET-UP	Page 5
PROGRAMMING	Page 6
CLEANING	Page 8
TROUBLESHOOTING	Page 8
DIAGNOSTIC TROUBLESHOOTING	Page 9-10
TRANSLATIONS (FRENCH, GERMAN, SPANISH, ITALIAN)	Page 11-34
WIRING DIAGRAM	Page 35

LIMITED WARRANTY

This product is warranted to be free from defects in material and/or workmanship for a period of (2) years from date of original installation not to exceed 30 months from date of shipment from our factory. Printed circuit boards and platen are warranted for a period of (3) years from date of original installation not to exceed 42 months from date of shipment from our factory. Any part or component which proves to be faulty in material and/or workmanship within the warranty period will be replaced or repaired without cost to the customer for parts or labor. (At the option of Prince Castle, Inc.)

This warranty is subject to the following exceptions/conditions:

- Any use of Non-genuine Prince Castle spare parts voids this warranty, and all work must be performed by an authorized Prince Castle Service Agent.
- All labor should be performed during regular working hours. Overtime premium will not be covered.
- Travel charges are limited to 200KM round trip, 2 hours travel time, one trip per repair.
- Damage caused by carelessness, neglect, and/or abuse (e.g., using wrong current, dropping, tampering with or altering electrical components, or improper cleaning) is not covered.
- Equipment damaged in shipment, by fire, flood or an act of God.

This manual is for the exclusive use of licensees and employees of McDonald's Systems, Inc.

Printed in January

Part No. 416-5009

SIDE VIEW

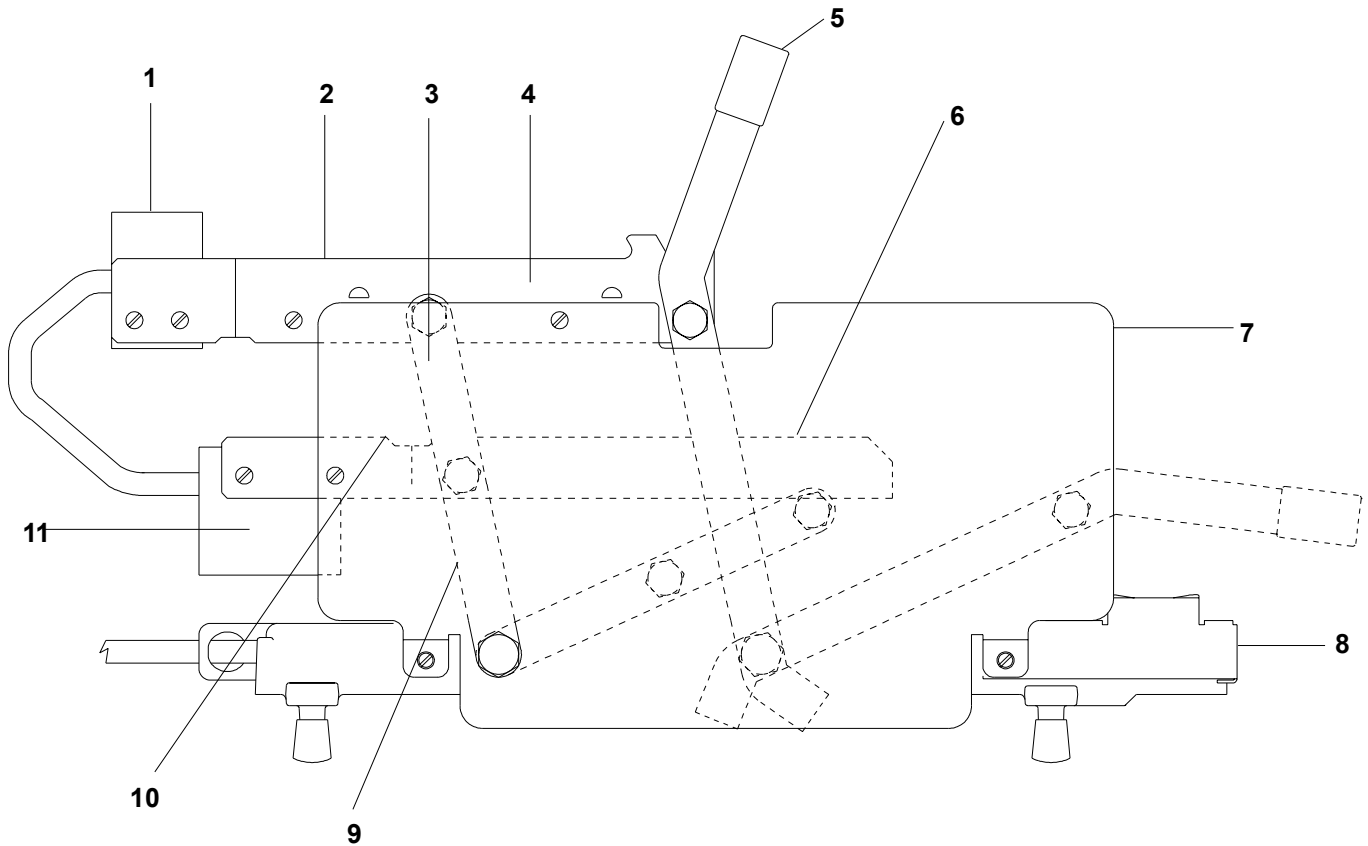

PARTS LIST

ITEM	PART NUMBER	DESCRIPTION
1	416-117	Upper Chassis
2	416-763	Upper Rear Bun Fence
3	416-858S	Rear Upper Lever Assy.
4	416-829	Left Hand Upper Bun Fence
	416-830	Right Hand Upper Bun Fence
5	416-413	Front Lever and Handle
6	416-802	Left Hand Lower Bun Fence
	416-801	Right Hand Lower Bun Fence
7	416-852	Side Panels (416-SFMCE & 416-SFK)
	416-787	Side Panels (416-S & 416-SP)
8	416-680	Base
9	416-856S	Rear Lower Lever Assy.
10	416-762	Lower Rear Bun Fence
11	416-843	Lower Chassis

FRONT VIEW

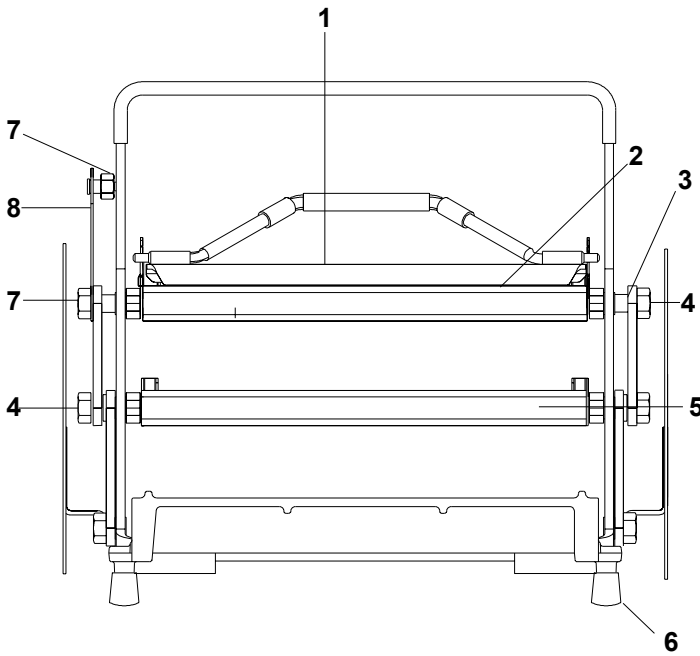

PARTS LIST

ITEM	PART NUMBER	DESCRIPTION
1	416-864	Bun Board
2	416-629S	Upper Platen 220-230V
	416-495S	Upper Platen 120V
	416-612S	Upper Platen 200V
3	212-283	Front Upper Spacer
4	212-285	Platen Bearing Stud
5	416-625S	Lower Platen 220-230V
	416-600S	Lower Platen 120V
	416-615S	Lower Platen 200V
6	89-959S	Black Rubber Foot (Pkg of 4)
7	213-304	Safety Latch Bearing
8	416-488	Safety Latch

REAR VIEW

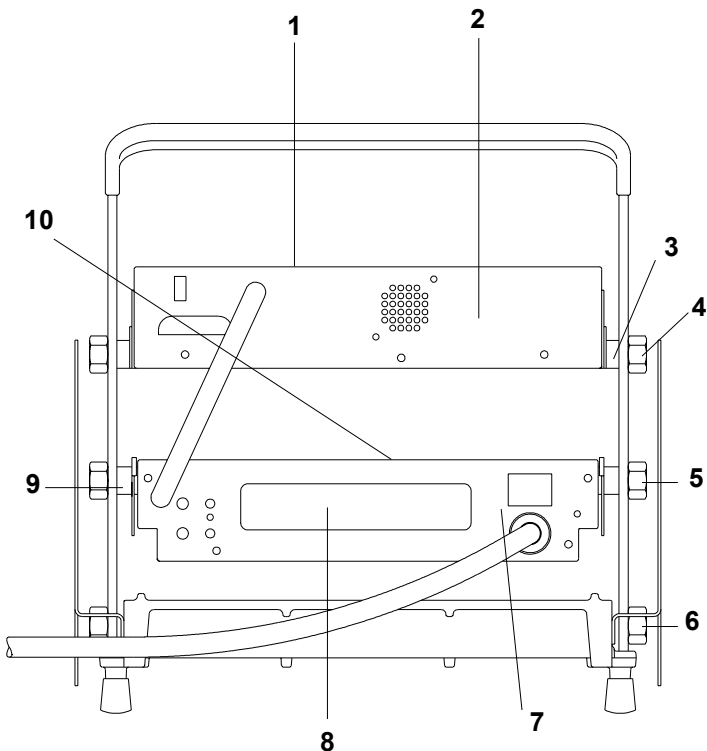

PARTS LIST

ITEM	PART NUMBER	DESCRIPTION
1	416-121	Upper Cover
2	416-753	Upper Faceplate
3	416-652	Upper Rear Spacer
4	416-653	Upper Rear Stud
5	416-654	Lower Rear Stud
6	212-284	Base Stud
7	416-755	Lower Faceplate Assy.
8	411-707	Overlay
9	212-283	Lower Platen Spacer
10	416-128	Lower Cover

INTERNAL VIEW UPPER CONTROL BOX

PARTS LIST

ITEM	PART NUMBER	DESCRIPTION
1	213-700S	Upper Probe
2	213-257S	Bun Done Light
3	213-229S	Speaker
4	416-717S	Interconnect Board
5	416-842	Interconnect Cable

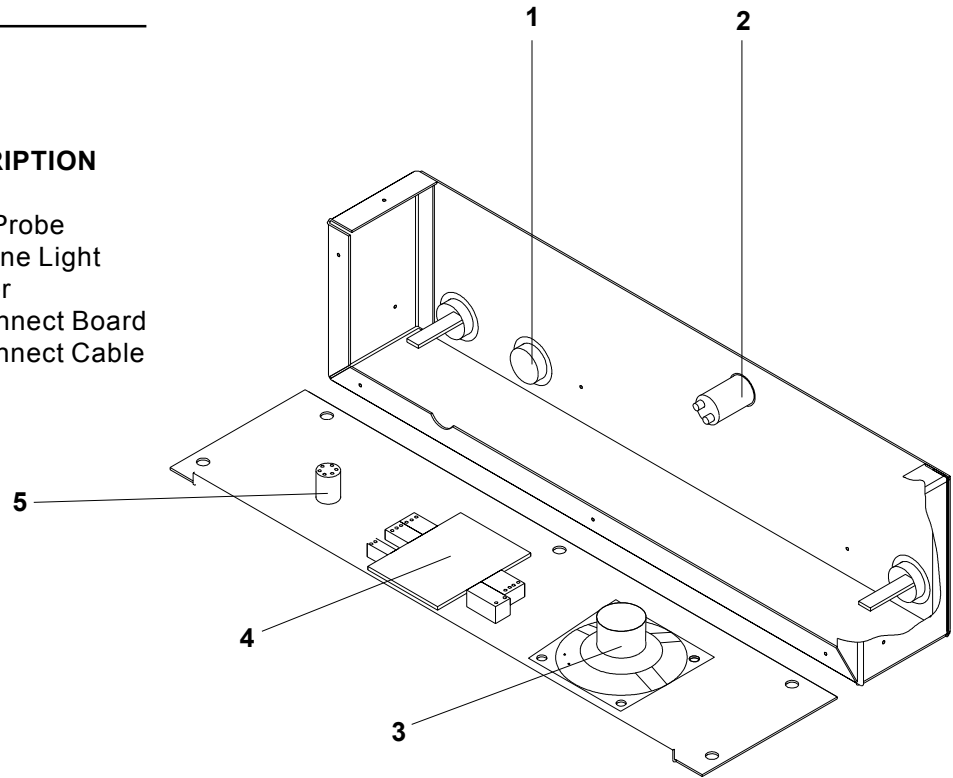

INTERNAL VIEW LOWER CONTROL BOX

PARTS LIST

ITEM	PART NUMBER	DESCRIPTION
1	78-146S	Timer Activating Switch
2	213-700S	Probe
3	65-053-04S	Relay
4	72-134S	Power Cord Only
5	78-166S	Rocker Switch
6	411-427-05S	Control PCB 220-230V
	411-601S	Control PCB 120V

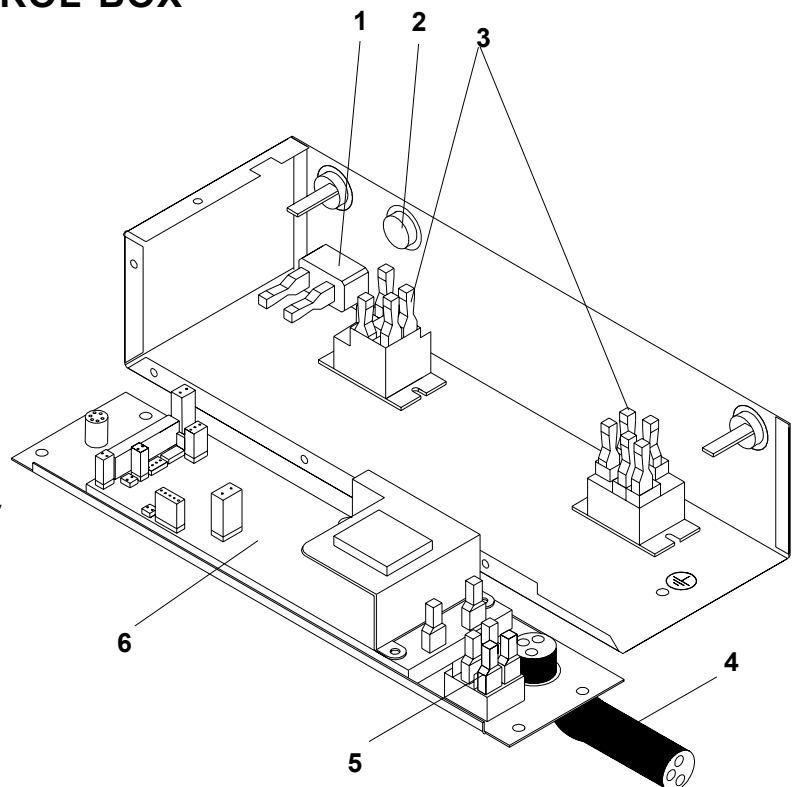

SYMBOLS & TERMS

C -- A Toaster is set on Celsius.

F -- A Toaster is set on Fahrenheit.

A L - Alarm Level setting 1-4.



Sound Button: Used with timer button and temperature button to set alarm level.



Timer Button: Used to view time in run mode. Used to set time in program mode.



Temperature Button: Used to view set point temperature in run mode, and used to set the set point temperature in program mode.



Up Arrow: Used to set time, sound and temperature in program mode.



Down Arrow: Used to set time, sound, and temperature in program mode.

FACTORY PRE-SET

Prince Castle's Solid State Digital Display toasters are pre-set at the factory.

If your toaster model is set for a 35 second toast time, then the temperature is pre-set and calibrated to 215°C(419°F).

If your toaster model is set for a 55 second toast time, then the temperature is pre-set and calibrated to 204°C(400°F).

SET-UP

1. Refer to the nameplate on the control box for the proper operating voltage. Connect the toaster to a grounded receptacle that matches the nameplate voltage information. Press the power switch to the on position, allow the unit 30 minutes to reach operating temperature.
2. The toaster is factory-set to display temperatures reading in Celsius. When the toaster is turned on, the digital display on the control box will read C--A for Celsius, and the "A" will begin to count down 9 seconds. During this countdown, you can change the temperature display from Celsius to Fahrenheit readings. To change temperature display, press

figure 1

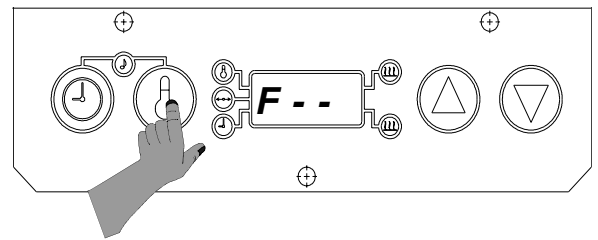

and hold the temperature button for six seconds. See figure 1.

3. During the pre-heat cycle, the display will read - L O -. When the platen temperature reaches 149° C (300° F), the display will begin to show the actual platen temperatures throughout the

figure 2

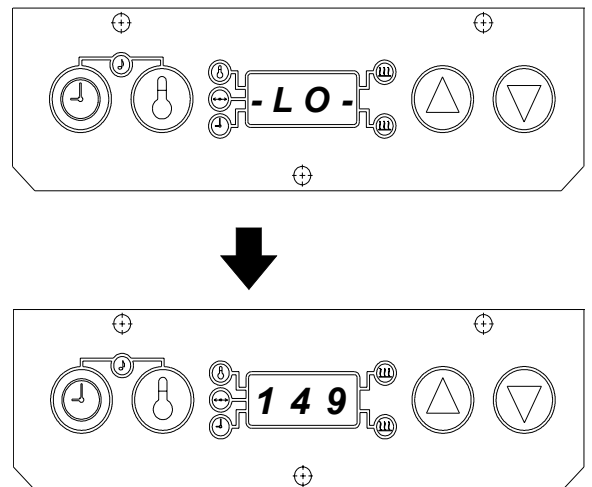

toasting cycles. See figure 2.



Sound Level Adjustment

The audio alarm has four sound levels.

1. Press and hold the time button and temperature buttons simultaneously. The display will show the current sound level. The toasters are factory set

figure 3

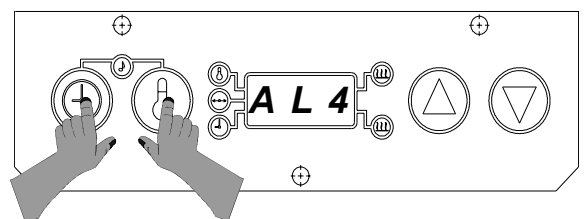

at level 4, and the display will read, **AL 4** for Alarm Level 4. See figure 3.

2. While holding the time and temperature buttons, press the up or down arrow buttons to adjust the sound level. A continuous tone will sound. Release all buttons when the desired sound level

figure 4

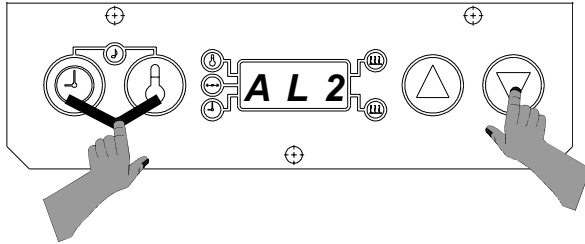

is reached. The display will show the current sound level. See figure 4.

VIEW SET POINT TEMPERATURE

1. Press and release the temperature button. (Do not hold for more than 6 seconds.) A beep will sound, the temperature indicator will turn on, and the display will show the set point temperature for three

figure 5

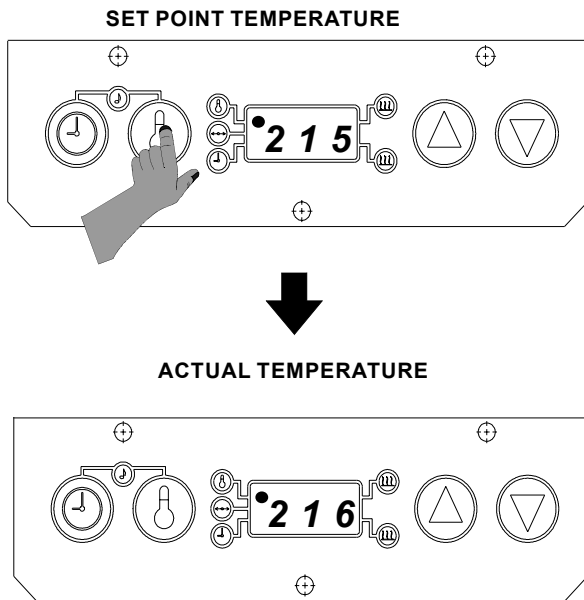

seconds. The display will then change to show the actual temperature. See figure 5.

VIEW TIMER SETTING

1. Press and release the time button. (Do not press the time button for more than 6 seconds.) The set time will be displayed for three seconds. If the timer is activated and is in a countdown sequence, the time remaining will be displayed, and will continue to countdown to zero. After

figure 6

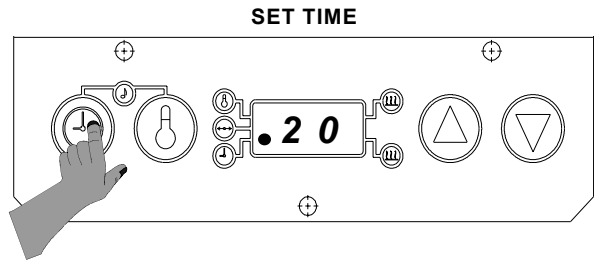

three seconds, the display will change to show actual platen temperature. See figure 6.

PROGRAMMING

The programming modes are used for setting individual set point temperature, and setting toast times.

Programming the Set Point Temperature

1. Press and hold the temperature button for six seconds. A beep will sound, the temperature

figure 7

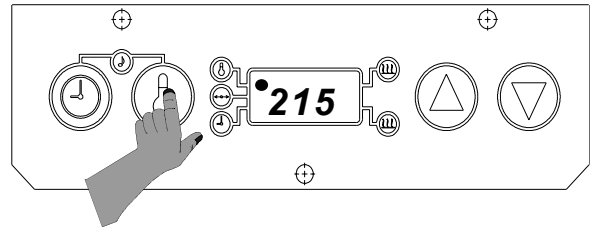

indicator light will blink, and the display will show the current set point temperature. See figure 7.

2. To change the set point temperature, use the up or down arrow. Once the desired temperature is

figure 8

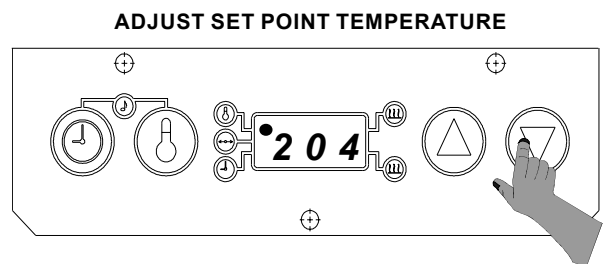

STORE SET POINT TEMPERATURE

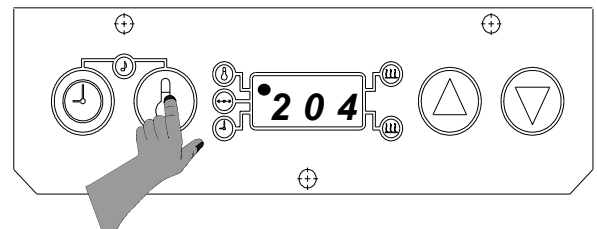

displayed, press the temperature button to store the new setting. See figure 8.

3. To cancel the set point programming mode at any time, press and release the time button. The

figure 9

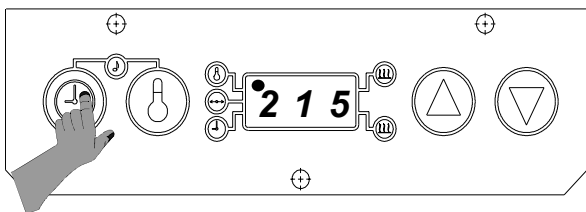

display will change to show the actual platen temperature. See figure 9.

Programming Toast Times

1. Press and hold the time button for 6 seconds. A beep will sound, and the time indicator light will

figure 10

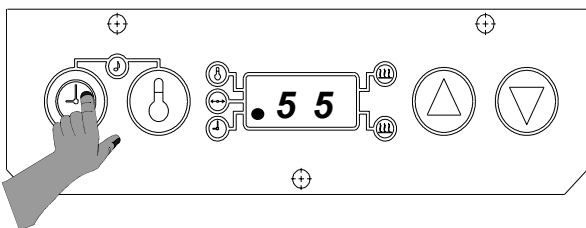

blink. Release the time button to show the current toast time. See figure 10.

2. Use the up and down arrow buttons to set your desired toast time. The range is from 20 seconds to 1 minute, 30 seconds. When desired time is

figure 11

SETTING THE NEW TIME

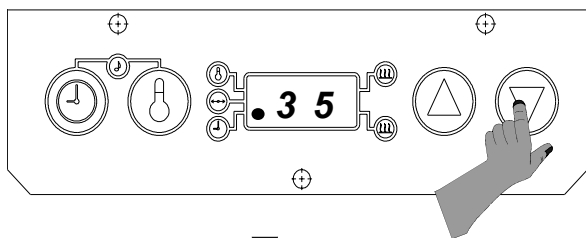

STORING THE NEW TIME

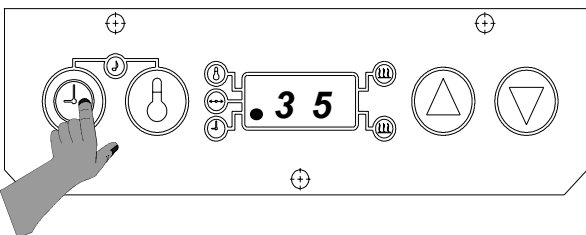

reached, press and release the time button to store the new time. See figure 11.

3. To cancel the time set function at any time, press and release the temperature button. The time indicator light will turn off, and the display will

figure 12

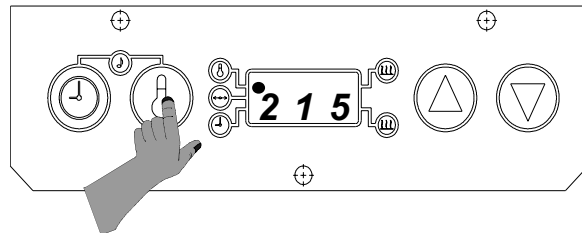

change to show the actual platen temperature. See figure 12.

ENERGY SAVING MODE

To conserve energy during non-toasting periods, pull the toaster handle down, so that the timing cycle activates. When the audio alarm goes off, indicating that the toasting time is complete, **DO NOT** pull the handle up. Allow the audio alarm to sound until the alarm shuts off, the display will alternately flash "Stand" and "By", indicating the toaster is in the energy savings mode. The toaster platens will continue to maintain the programmed operating temperature, raising the toaster handle will put the toaster back into the operation mode.

SETTING STOP BLOCKS

Stop blocks allow for proper crush when toasting buns. The toaster leaves the factory with the stop blocks set on number 3. The stop blocks are located toward the front of the toaster on the right and left sides of the base. To increase the crush, set the stop blocks to the number 2 setting. To decrease the crush, set the stop block to the number 4 setting. See figure 13.

IMPORTANT: The stop blocks are set at the number that is touching the lever. The example in figure 13 shows a stop block setting of 1.

1. To change the stop block setting, depress the right stop block and disengage the locking pin.

figure 13

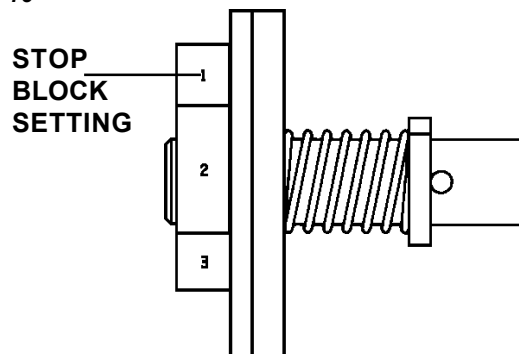

CLEANING

1. Press the power switch to the off position.
2. Unplug toaster.
3. Allow toaster and platens to cool down.
4. Wipe entire platen with clean, damp grill cloth.
Full toaster cleaning must be done in the morning when toaster is cold. See your *Planned Maintenance Card* for proper cleaning procedures.







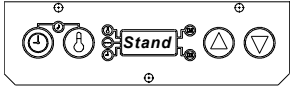
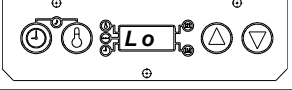
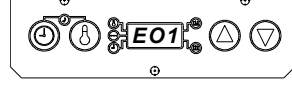

IMPORTANT: Do not drape cord over hot toaster bun board or platen. This will cause cord to burn.

TROUBLESHOOTING GUIDE

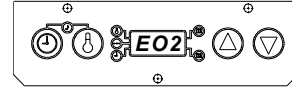
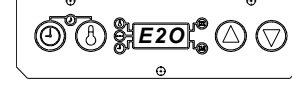
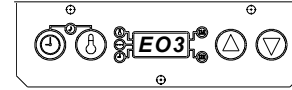
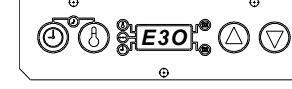
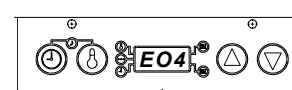
PROBLEM	CAUSE	SOLUTION
Platen loose.	Platen bolts loose.	Tighten platen bolts.
Buns being crushed.	Stop blocks not adjusted properly. Warped bun trays. Buns cut improperly.	Adjust stop blocks. Straighten or replace bun trays. Contact bakery.
No Display.	Fuse Defective.	Check fuse with ohmmeter, reading should be 1-2 ohms.

DIAGNOSTIC SIGNALS

This toaster comes with self-diagnostic signals. When the P.C. Board senses a component failure, the display will change from showing the actual temperature to one of the signals listed on the following two pages, an audio alarm will sound when an error code message is displayed. There are two different error code alarms. During a "LO" temp signal, the alarm will alternately beep 5 times then pause for 5 seconds until the platen heats back up to the toasting temperature. All other error code messages will be accompanied by an alarm that alternately sounds for 6 seconds then goes silent for 2 minutes.

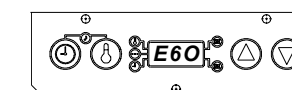
Diagnostics	Problem	Solution
	Display alternately flashes “Stand” and “bY” Toaster in Energy Saving Mode	Raise handle to begin toasting. If display doesn’t change, replace timer switch.
	Platen temperature dropped 54°F (12°C) below set point temperature.	Stop toasting for 5-10 minutes to allow toaster to reach set point temperature
	1. Lower Relay Contacts Shorted. Lower Platen Overheating.	Replace Lower Relay.
	1. Upper Relay Contacts Shorted. Upper Platen Overheating.	Replace Upper Relay.
	2. Lower Probe Open.	Replace Lower Probe.
	2. Upper Probe Open	Replace Upper Probe.
	3. Lower Failures E01 And E02	Replace Lower Relay & Probe
	3. Upper Failures E10 And E20 or Interconnect board failure.	Replace Upper Relay & Probe or Replace Interconnect Board
	4. Lower Platen Underheating.	Replace Lower Relay. Check Lower Platen Resistance.
	4. Upper Platen Underheating.	Replace Upper Relay Check Upper Platen Resistance.
	4. Both Platens Underheating.	Replace Both Relays. Check resistance on platens.
<p>NOTE: E04, E40 and E44 codes indicate the platen temperatures have dropped 90° F or 30°C below the set point temperature and can be caused by the following:</p> <ol style="list-style-type: none"> 1. Cool air blowing on the platens 2. Low voltage applied to toaster. 3. Continued toasting during “LO” temp periods. 4. Defective P.C. Board. 		
	5. Lower Failures E01 And E04	Replace Lower Relay
	5. Upper Failures E10 And E40	Replace Upper Relay
	6. Lower Failures E02 And E04	Replace Lower Relay & Probe
	6. Upper Failures E20 And E40	Replace Upper Relay & Probe

 	<p>7. Lower Failures E01, E02 And E04</p> <p>7. Upper Failures E10, E20 And E40</p>	<p>Replace Lower Relay & Probe</p> <p>Replace Upper Relay & Probe</p>
 	<p>8. Lower Probe Circuit Failure.</p> <p>8. Upper Probe Circuit Failure.</p>	<p>Replace P. C. Board.</p> <p>Replace P. C. Board.</p>
 	<p>9. Lower Failures E01 And E08</p> <p>9. Upper Failures E10 And E80</p>	<p>Replace Lower Relay & PC Board</p> <p>Replace Upper Relay & PC Board</p>
 	<p>10. Lower Failures E02 And E08</p> <p>10. Upper Failures E20 And E80</p>	<p>Replace Lower Probe & PC Board</p> <p>Replace Upper Probe & PC Board</p>
 	<p>11. Lower Failures E01, E02 And E08</p> <p>11. Upper Failures E10, E20 And E80</p>	<p>Replace Lower Relay, Probe & PC Board</p> <p>Replace Upper Relay, Probe & PC Board.</p>
 	<p>12. Lower Failures E04 And E08</p> <p>12. Upper Failures E40 And E80</p>	<p>Replace Lower Relay & PC Board</p> <p>Replace Upper Relay & PC Board</p>
 	<p>13. Lower Failures E01, E04 And E08</p> <p>13. Upper Failures E10, E40 And E80</p>	<p>Replace Lower Relay & PC Board</p> <p>Replace Upper Relay & PC Board</p>
 	<p>14. Lower Failures E02, E04 And E08</p> <p>14. Upper Failures E20, E40 And E80</p>	<p>Replace Lower Probe, Relay & PC Board</p> <p>Replace Upper Probe, Relay & PC Board.</p>

WIRING DIAGRAM

