

Mini Wiring Diagram Continued

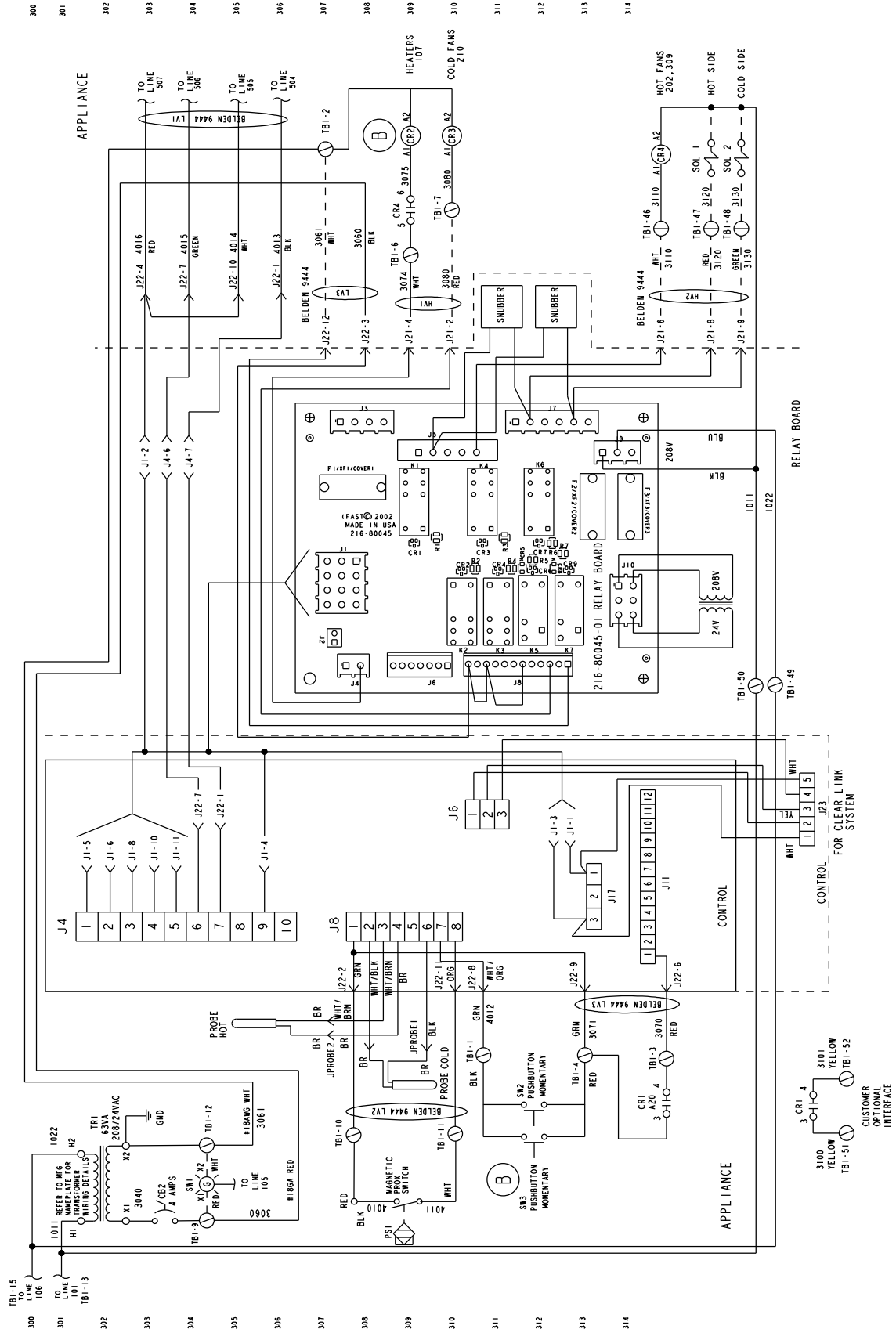

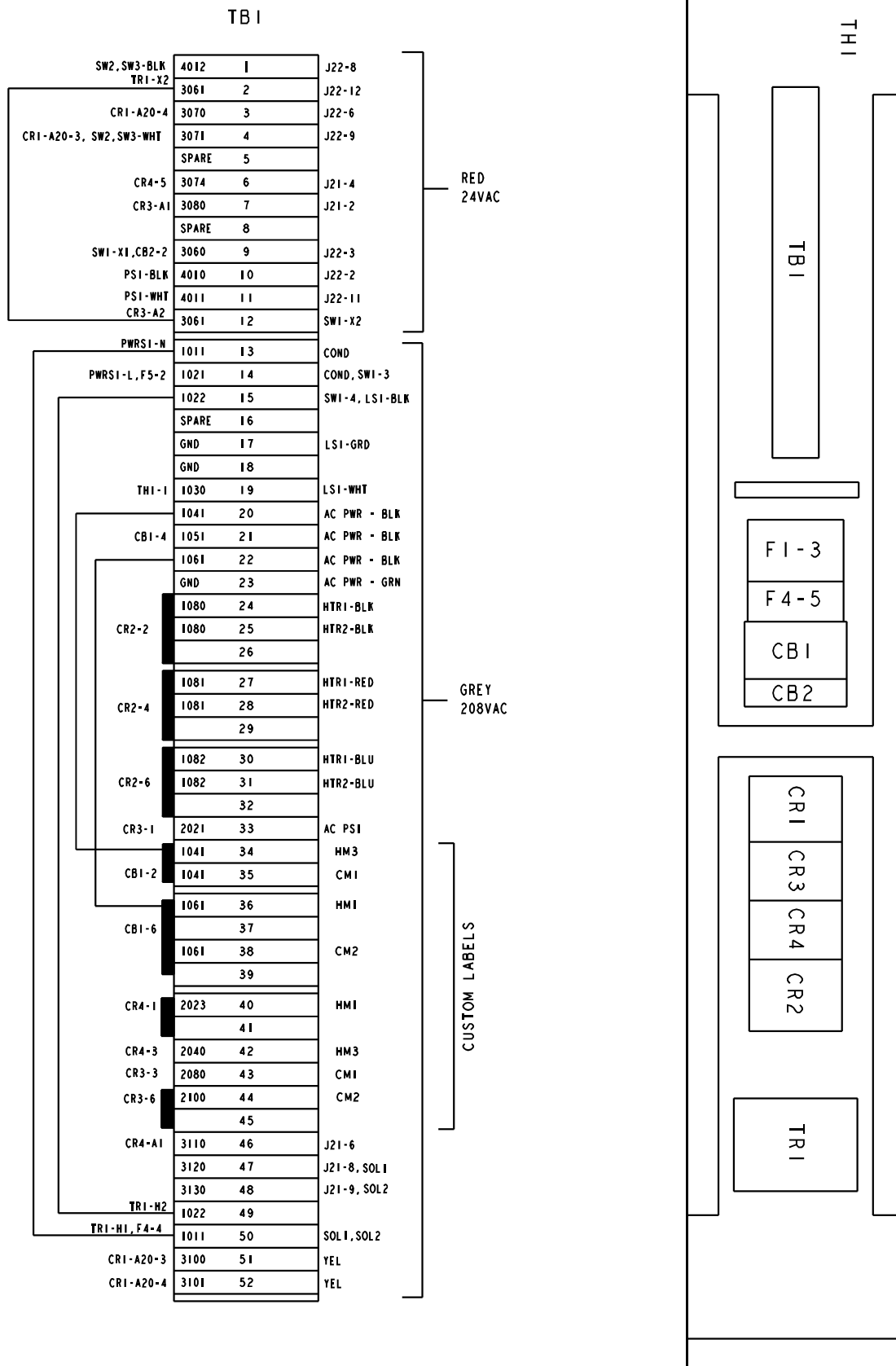

Mini Wiring Diagram Continued

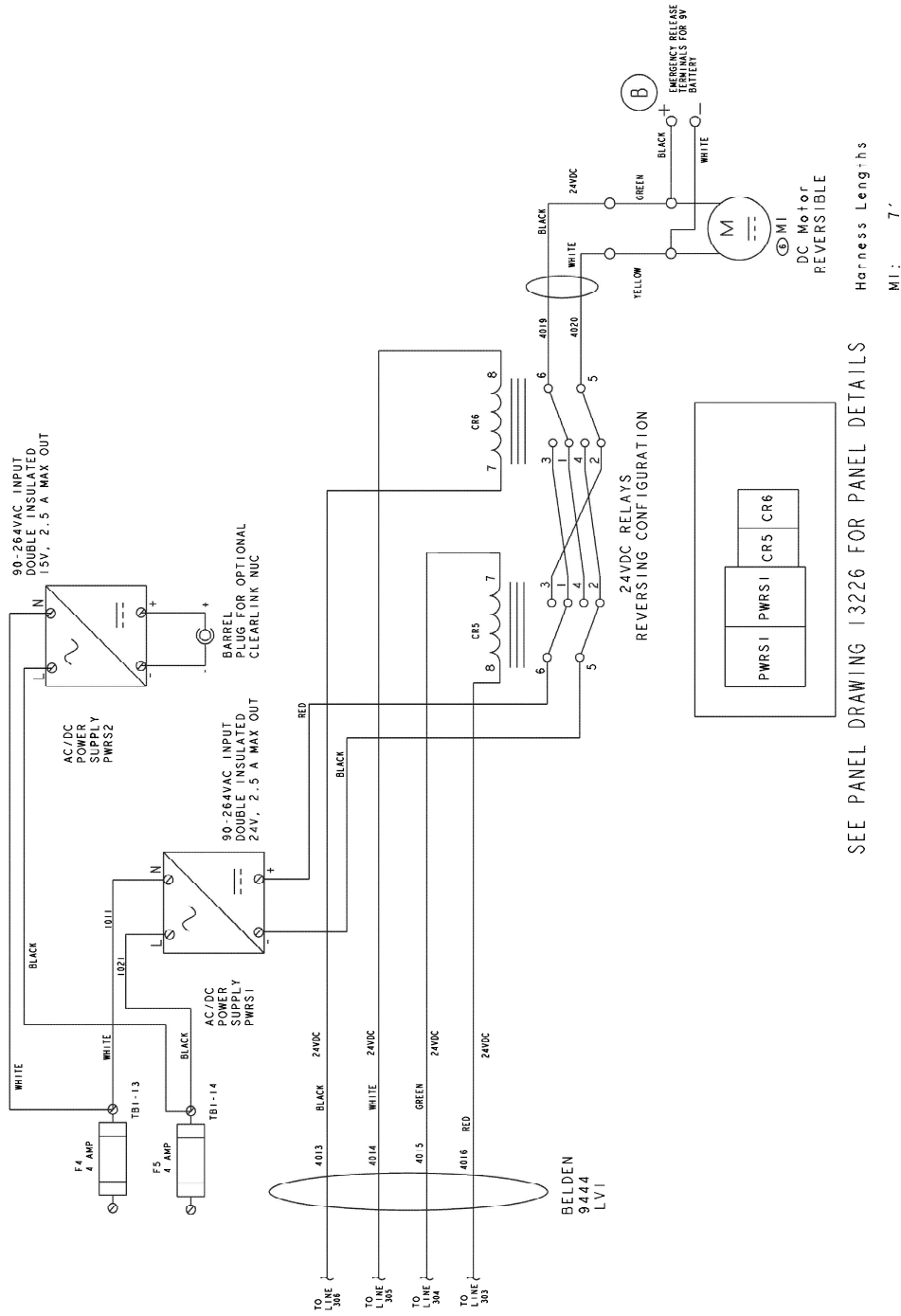

500
501
502
503
504
505
506
507
508
509
510
511
512
513
514

SEE PANEL DRAWING 13226 FOR PANEL DETAILS

Harness Lengths
MI : 7'

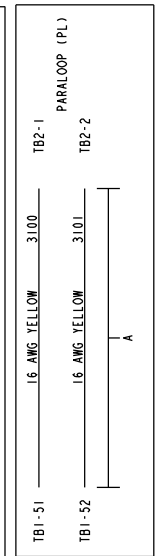
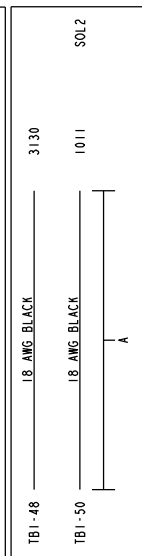
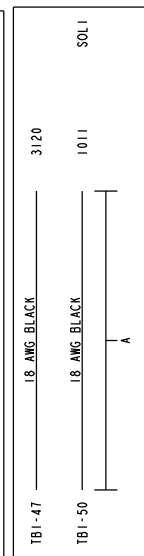
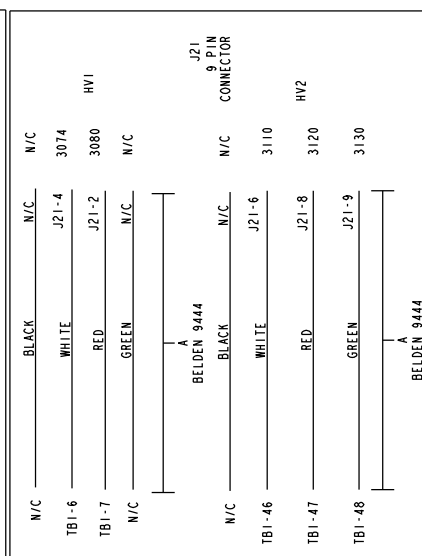
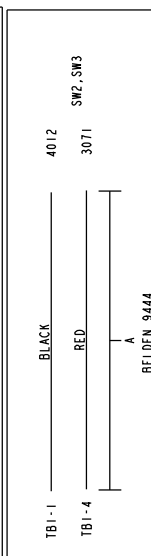
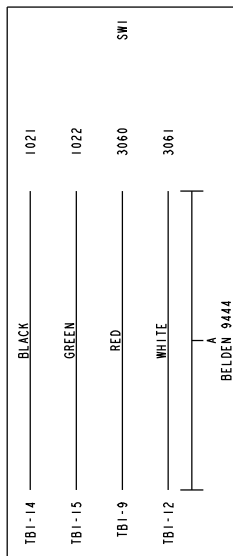
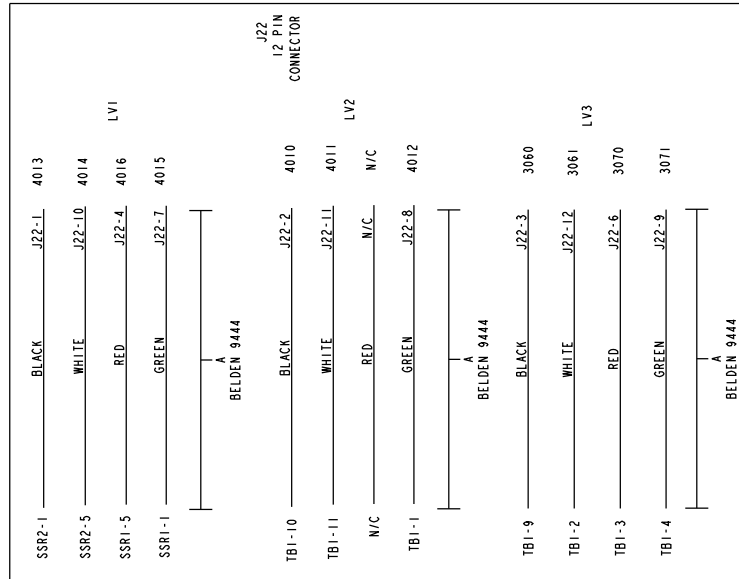
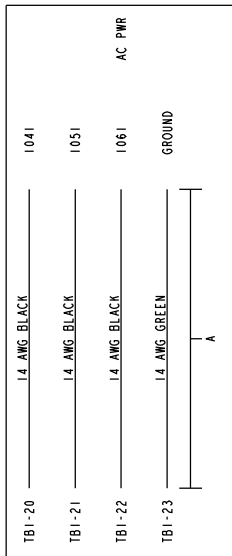
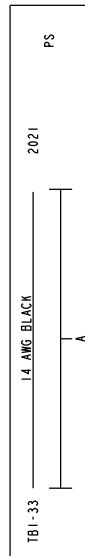
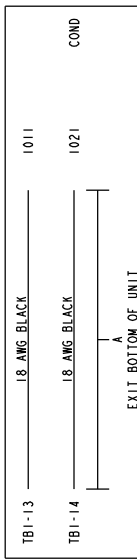
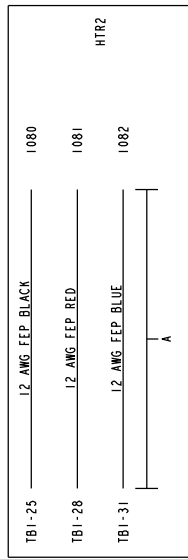
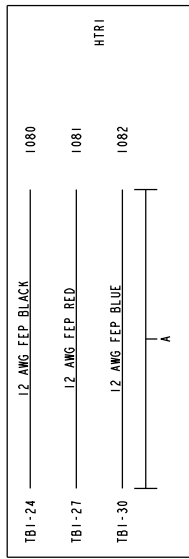

HARNES LENGTHS		CABLE	LENGTH
SW1, SW2, SW3	PS		7'
	AC PWR		7'
J21 9P IN CONNECTOR	HV1		7'
	HV2		7'
	LVI		7'
J22 12P IN CONNECTOR	LV2		7'
	LV3		7'
	COND		7'
HTR1		7'	
HTR2		7'	
SV1		7'	
SV2		7'	
PARALOOP (PL)		7'	

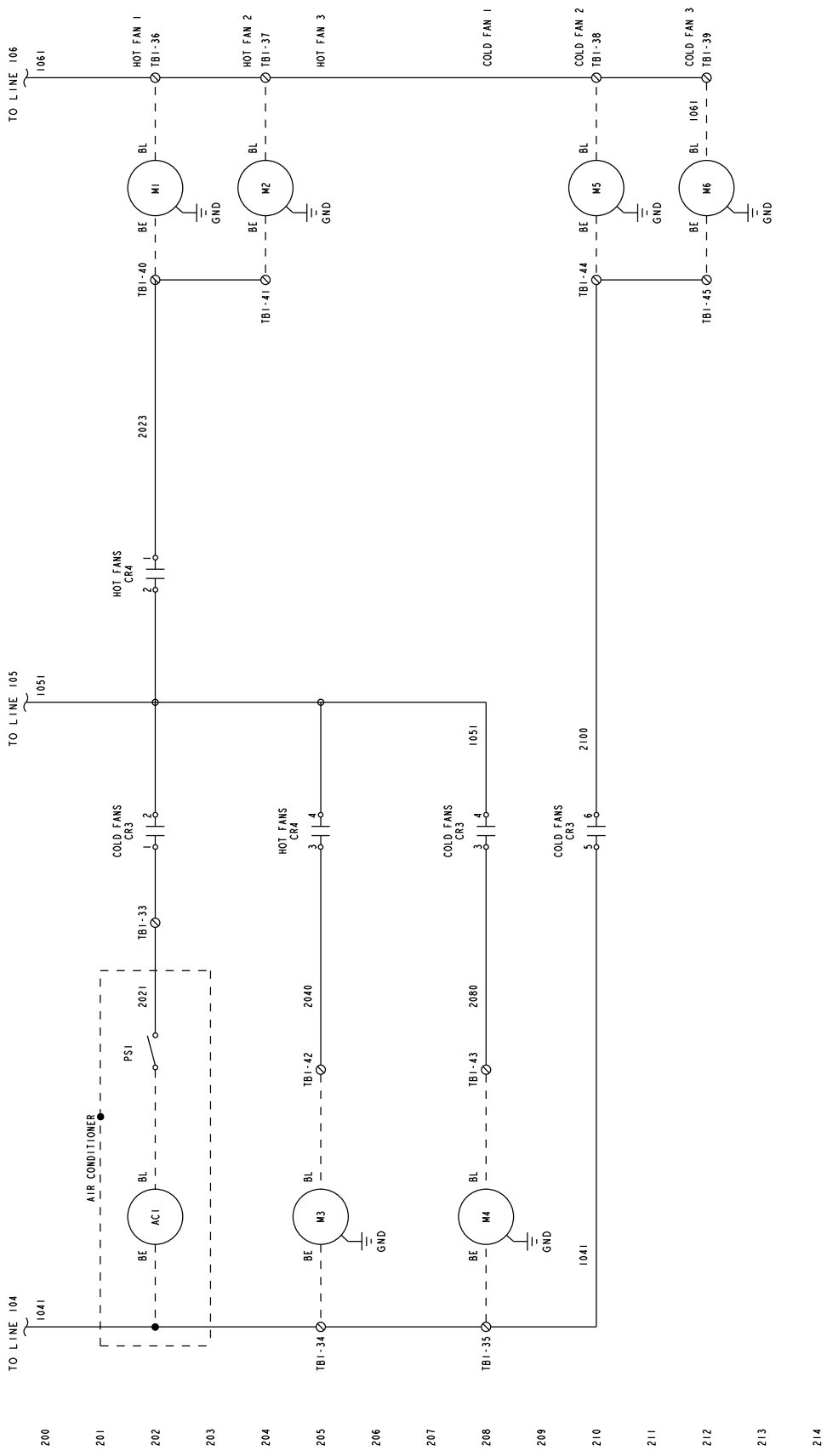

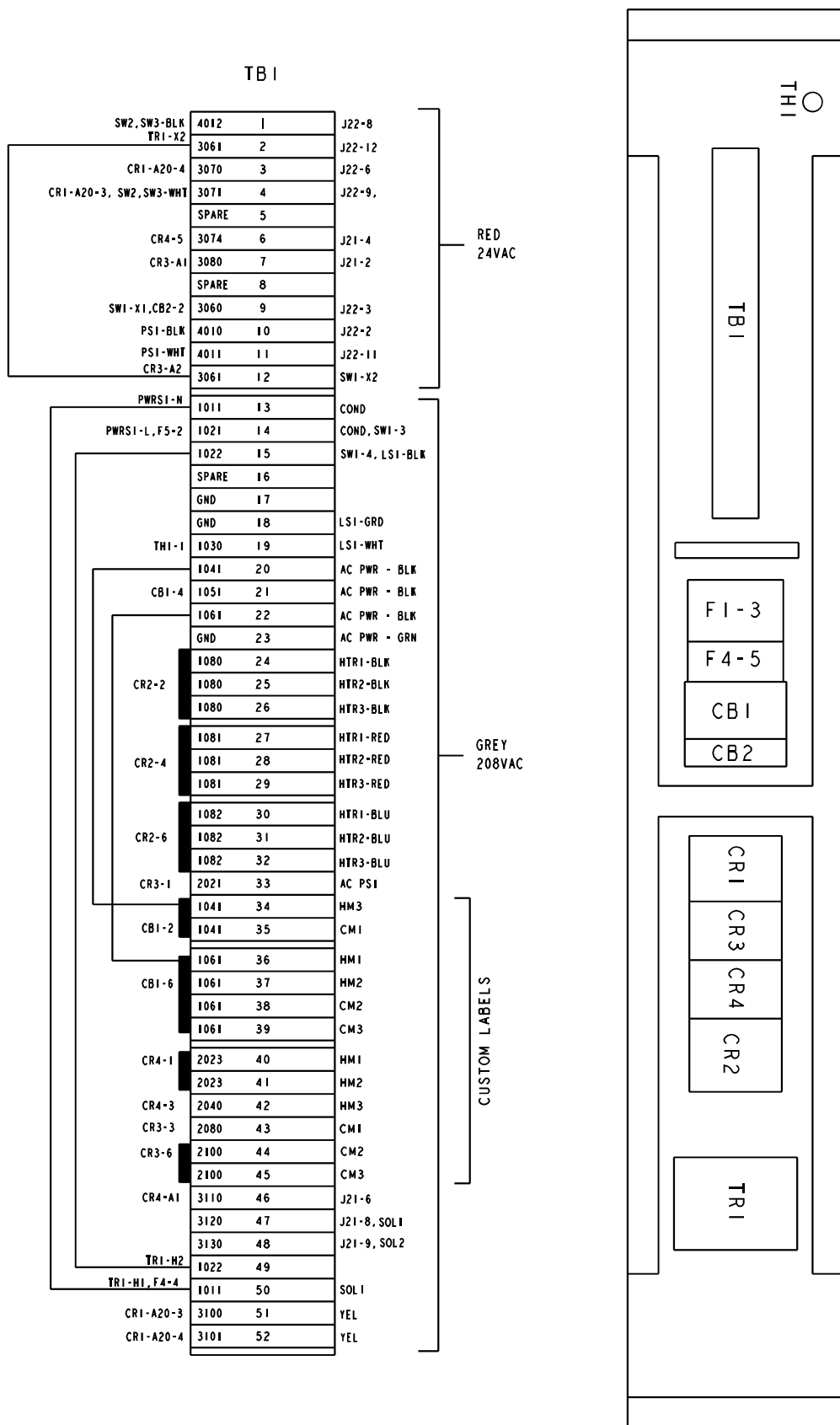

Junior

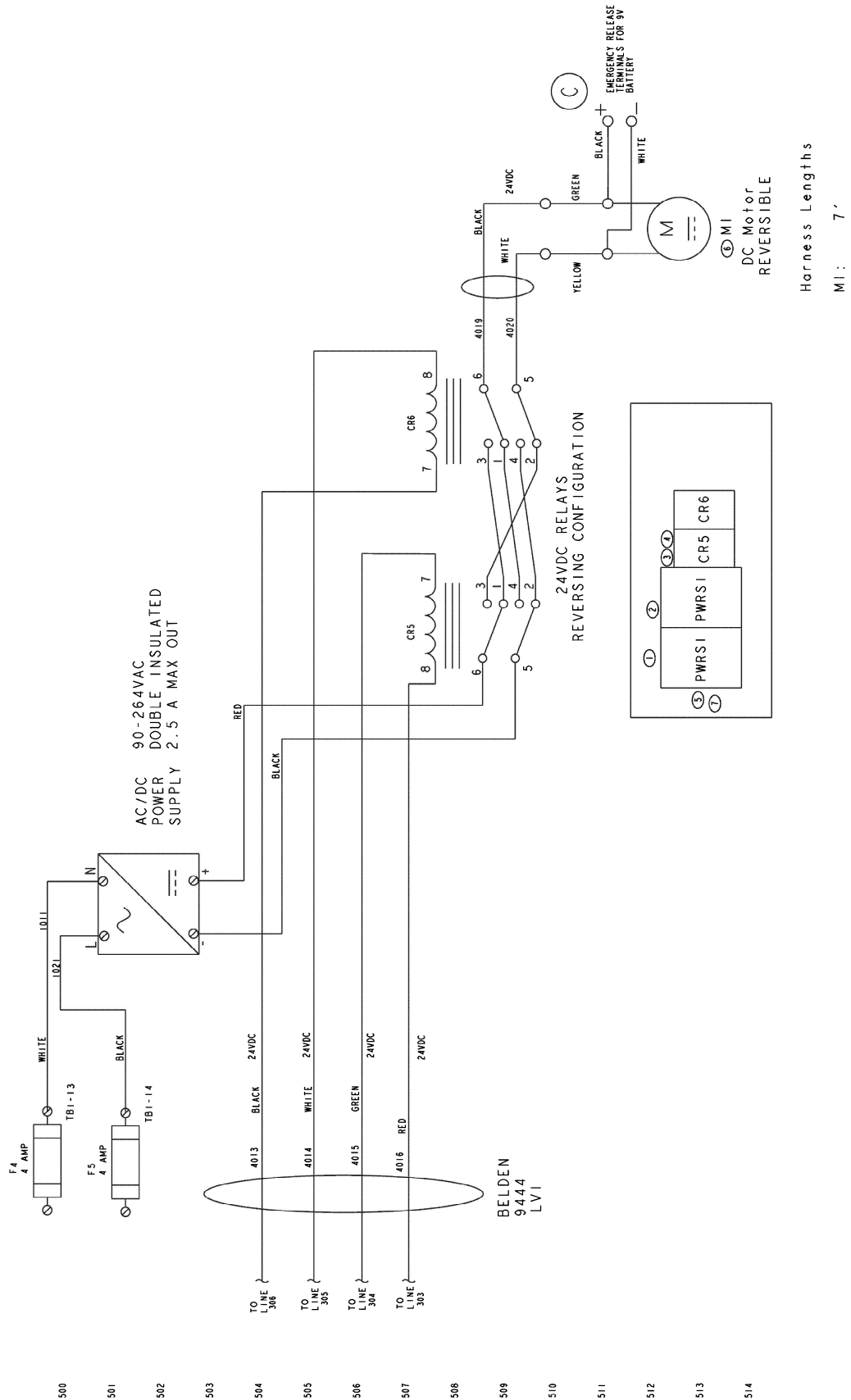

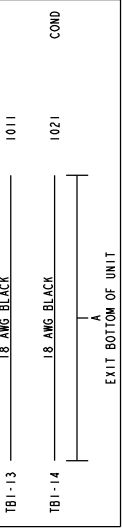
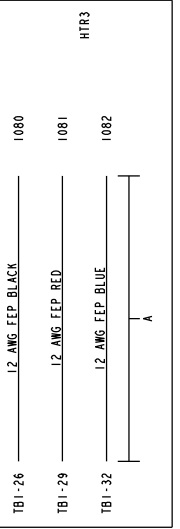
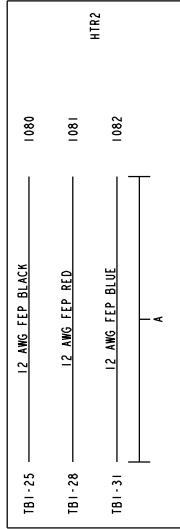
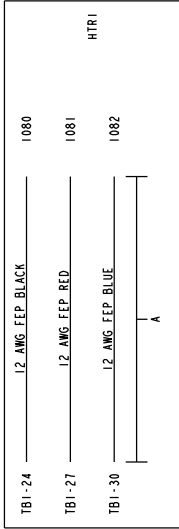

CABLE	LENGTH
SW1, SW2, SW3	7'
PS	7'
AC PWR	7'
J21, 9P IN CONNECTOR	7'
HV1	7'
HV2	7'
LV1	7'
J22, 12P IN CONNECTOR	7'
LV2	7'
LV3	7'
COND	7'
HTR1	7'
HTR2	7'
HTR3	7'
SV1	7'
SV2	7'
PARALOOP (PL)	7'

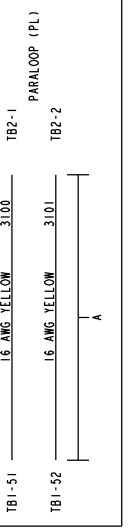
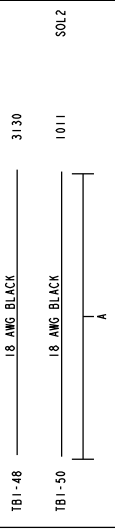
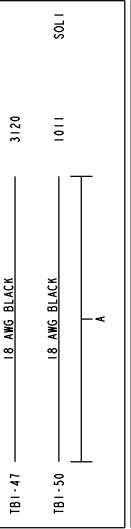
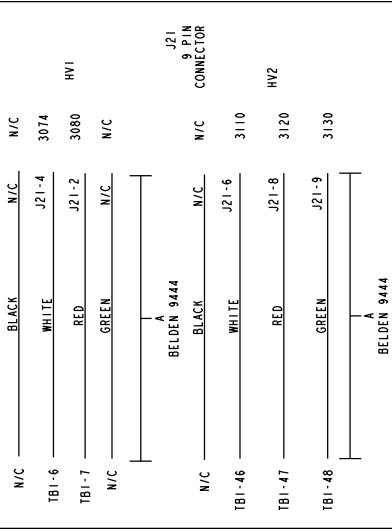
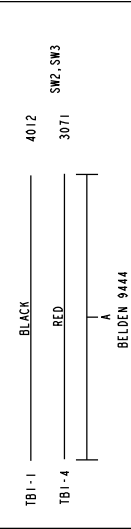
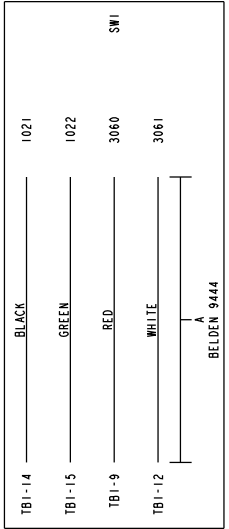
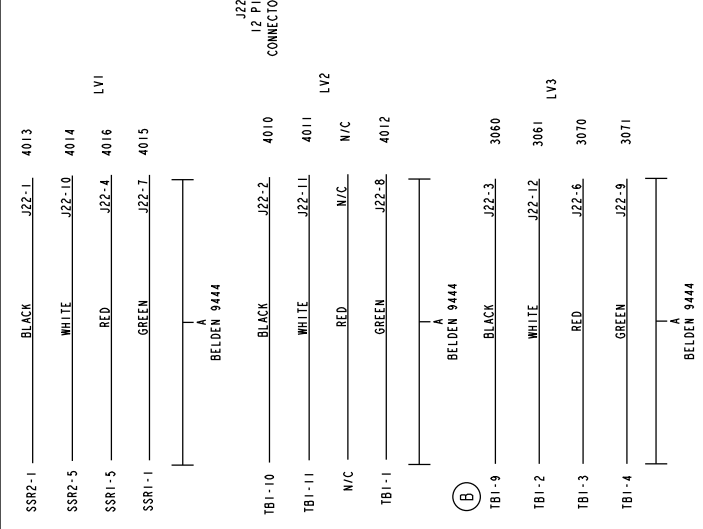
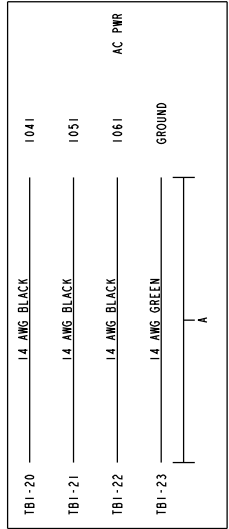
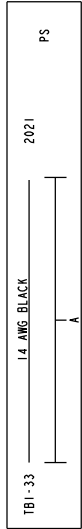

OPTIONAL SAFE TEMP II WI-FI WIRING DIAGRAM

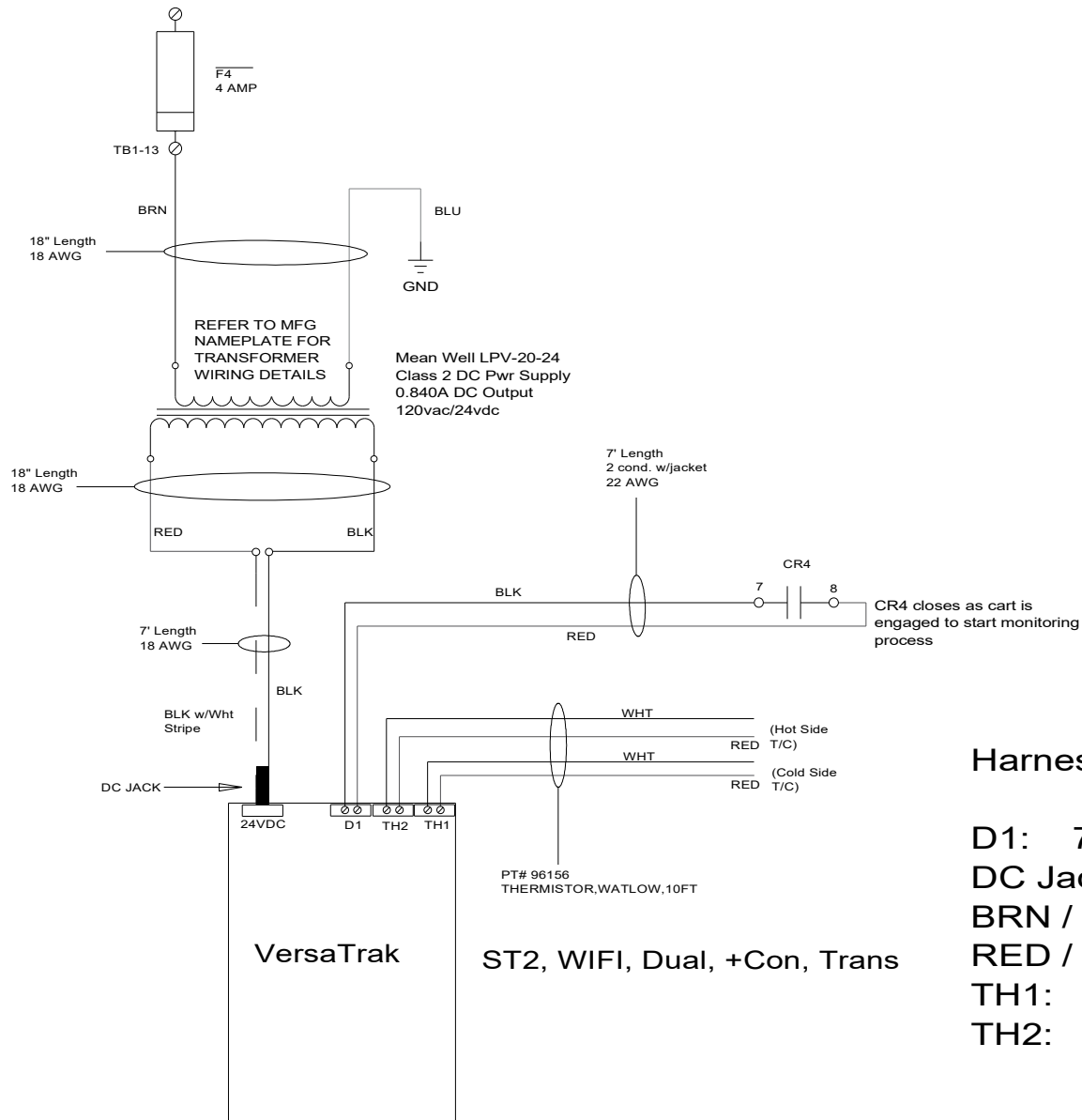

Harness Lengths

- D1: 7'
- DC Jack: 7'
- BRN / BLU: 18"
- RED / BLK: 18"
- TH1: 10'
- TH2: 10'

ST2, WIFI, Dual, +Con, Trans