



1000-BQ2/96



1000-BQ2/128



1000-BQ2/192

Hot Food Holding

1000-BQ2/96

1000-BQ2/128

1000-BQ2/192

- Installation
- Operation
- Maintenance

W164 N9221 Water Street • P.O. Box 450
Menomonee Falls, Wisconsin 53052-0450 U.S.A.

PHONE: 262.251.3800 • 800.558.8744 U.S.A. / CANADA
FAX: 262.251.7067 • 800.329.8744 U.S.A. ONLY
www.alto-shaam.com



Consult instructions for operation and use.

Manufacturer's Information

Copyright

© Copyright 04/25 by Alto-Shaam, Inc.

All rights reserved.

This manual or any portion thereof may not be reproduced or used in any manner whatsoever without the express written permission of Alto-Shaam, Inc.

Trademarks

All trademarks referenced in this documentation are the property of their respective owners.

Manufacturer

Alto-Shaam, Inc.

P.O. Box 450

W164 N9221 Water Street

Menomonee Falls, WI 53052

Original Instructions

The content in this manual is written in American English.

Warranty and Service Information 4
Delivery 5
Unpacking 6
Safety Procedures..... 7
Labels 9
Installation 10
Electrical Connection 14
Operation 17
Cleaning and Preventative Maintenance 19
Troubleshooting..... 21
Wire Diagrams 23
Warranty 24

Enjoy your Alto-Shaam Mobile Banquet Cart!

Halo Heat® Technology

Time stands still. Only Alto-Shaam Mobile Banquet Carts use Halo Heat® technology. No fans or harsh heating elements. There's more to hot food holding than just keeping food hot. Support food production and extend preparation times outside of peak hours while maintaining the highest quality of food.

Register your Appliance

Register

Registering your appliance ensures prompt service in the event of a warranty claim. You will also receive direct notifications of software updates and additional product information.

Your personal information will not be shared with any other company.

www.alto-shaam.com/warranty

Alto-Shaam 24/7 Emergency Repair Service

Call

Call 800-558-8744 to reach our 24-hour emergency service call center for immediate access to local authorized service agencies outside standard business hours. The emergency service access is provided exclusively for Alto-Shaam equipment and is available throughout the United States through Alto-Shaam's toll free number.

Availability

Emergency service access is available seven days a week, including holidays.

This Alto-Shaam appliance has been thoroughly tested and inspected to ensure only the highest quality appliance is provided. Upon receipt, check for any possible shipping damage and report it at once to the delivering carrier.

This appliance, including unattached items and accessories, may be delivered in one or more packages. Ensure all standard items and options have been received with each appliance as ordered. Save all the information included with the appliance. Register the appliance online at www.alto-shaam.com/en/customer-support/warranty-registration to ensure prompt service in the event of a warranty parts and labor claim.

This manual must be read and understood by all people using or installing the appliance. Contact the Alto-Shaam Tech Team Service Department if you have any questions concerning installation, operation, or maintenance.

1-800-558-8744; servicedept@alto-shaam.com

The serial number is required for all inquiries.
 Always include both model and serial number(s) in any correspondence regarding the appliance.

Model: _____

Serial number: _____

Purchased from: _____

Date installed: _____ **Voltage:** _____

CAUTION

Appliance and accessories may be heavy. To prevent serious injury, **always** use a sufficient number of trained and experienced workers when moving or leveling appliance and handling accessories.

Environmental Conditions

- Operational Environmental Conditions
- Before use, appliance must acclimate to room temperature in the environment it is placed – 24 hours is recommended.
 - Ambient temperature range of 60°F to 110°F (16°C to 43°C).
 - Relative humidity of less than 95% non-condensation.
 - Atmospheric pressure range of 50kPa to 106kPa.

Unpacking

- Carefully remove the appliance from the carton or crate.

NOTE: Do not discard the carton and other packaging material until you have inspected the appliance for hidden damage and tested it for proper operation.

Do not discard this manual. This manual is considered to be part of the appliance and is to be provided to the owner or manager of the business or to the person responsible for training operators. Additional manuals are available from the manufacturer.

- Read all instructions in this manual carefully before installing this appliance, using the appliance or performing routine maintenance. Following procedures other than those indicated in this guide to use and clean the appliance is considered inappropriate and may cause damage, injury or fatal accidents, in addition to voiding the warranty and relieving Alto-Shaam of all liability.
- Remove all protective plastic film, packaging materials, and accessories from the appliance before connecting electrical power. Store any accessories in a convenient place for future use.

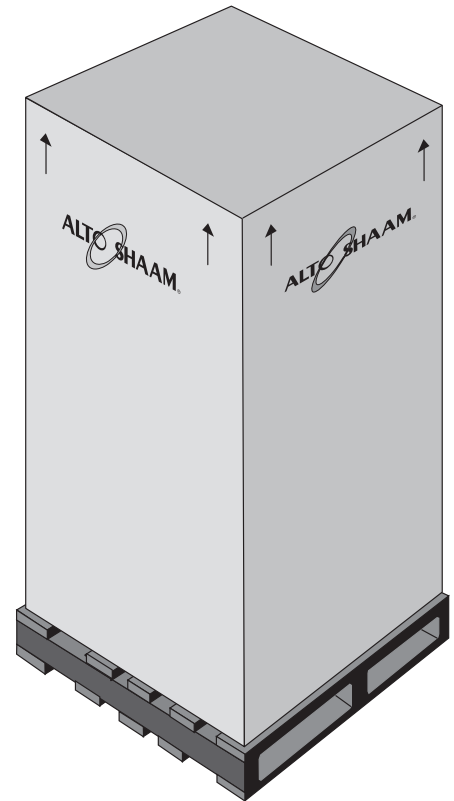

- The appliance is intended to hold hot food for the purpose of human consumption. No other use for this appliance is authorized and is therefore considered dangerous.
- The appliance must not be used to hold food containing flammable materials (such as food with alcohol). Substances with a low flash point can ignite spontaneously and cause a fire.
- The appliance is intended for use in commercial establishments where all operators are familiar with the purpose, limitations, and associated hazards of this appliance. Operating instructions and warnings must be read and understood by all operators and users.
- This appliance is intended to be used for commercial applications, for example in kitchens of restaurants, canteens, hospitals and in commercial enterprises such as bakeries, butcheries, etc., but not for continuous mass production of food.
- This appliance is not intended to be used by laymen in household and similar applications such as: staff kitchen areas in shops, offices, and other working environments; farmhouses, hotels, motels and other residential type environments; bed and breakfast type environments.
- Any troubleshooting guides, component views, and parts lists included in this manual are for general reference only and are intended for use by qualified and trained technicians.
- This manual should be considered a permanent part of this appliance. This manual and all supplied instructions, diagrams, schematics, parts lists, notices, and labels must remain with the appliance if the appliance is sold or moved to another location.

The following signal words and symbols may be used throughout this manual.

⚠ DANGER

Indicates a hazardous situation that, if not avoided, will result in death or serious injury.

⚠ WARNING

Indicates a hazardous situation that, if not avoided, could result in death or serious injury.



⚠ CAUTION

Indicates a hazardous situation that, if not avoided, could result in minor or moderate injury.

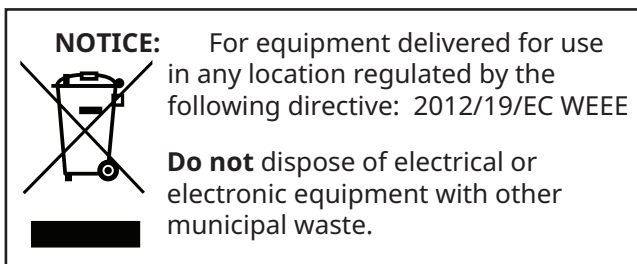
NOTICE: Indicates information considered important, but not hazard-related (e.g., messages relating to property damage).



- To prevent serious injury, death or property damage, the appliance should be inspected and serviced at least every twelve (12) months by an authorized service partner or trained technician.
- **Only** allow an authorized service partner or trained technician to service or to repair the appliance. Installation or repairs that are not performed by an authorized service partner or trained technician, or the use of non-factory authorized parts will void the warranty and relieve Alto-Shaam of all liability.
- When working on this appliance, observe precautions in the literature, on tags, on labels attached to or shipped with the appliance and other safety precautions that may apply.
- If the appliance is installed on casters, freedom of movement of the appliance must be restricted so that utility connections (including gas, water, and electricity) cannot be damaged when the appliance is moved. If the appliance is moved, ensure that all utility connections are properly disconnected. If the appliance is returned to its original position, ensure that retention devices and utility connections are properly connected.
- **Only** use the appliance when it is stationary. Mobile appliance racks, mobile plate racks, transport trolleys, and appliances on casters can tip over when being moved over an uneven floor or threshold and cause serious injury.
- **Always** apply caster brakes on mobile appliances or accessories when these are not being moved. These items could move or roll on uneven floors and cause property damage or serious injury.
- Be extremely careful when moving appliances because the food trays may contain hot fluids that may spill, causing serious injury.
- **Always** open the appliance door very slowly. Escaping hot vapors or steam can cause serious injury.

 WARNING	
	<p>To prevent serious personal injury, death, or property damage:</p> <p>The appliance must be cleaned thoroughly to avoid deposits of grease and or food residue inside the appliance that may catch fire. If fat deposits and/or food waste inside the appliance ignite, shut down the appliance immediately and keep the appliance door closed to extinguish the fire. If further extinguishing is required, disconnect the appliance from the main power and call the fire department. Failure to clean the appliance properly voids the warranty and relieves Alto-Shaam of all liability.</p>

Operator qualifications

Only trained personnel with the following operator qualifications are permitted to use the appliance:





- Have received proper instruction on how to use the appliance.
- Have demonstrated their ability with commercial kitchens and commercial appliances.

The appliance must not be used by:

- Persons (including children) with reduced physical, sensory or mental capabilities, or lack of experience and knowledge, unless they have been given supervision concerning use of the appliance by person responsible for their safety.
- People impaired by drugs or alcohol.

Regarding children:

- Children should be supervised to ensure that they do not play with the appliance.
- Children shall neither clean nor maintain the appliance.

	<p>Made in U.S.A.</p>
	<p>Security seal</p>
<p>ALTO-SHAAM</p> <p>Every Alto-Shaam product is precision calibrated prior to release from the factory to ensure accurate temperature control.</p> <p>CALIBRATION TECHNICIAN _____</p> <p>LA-26378</p>	<p>Every Alto-Shaam product is precision calibrated prior to release from the factory to ensure accurate temperature control.</p>
	<p>WARNING Hot surface</p>
<p>For use on individual branch circuit only.</p> <p>Utiliser exclusivement sur un propre circuit de dérivation séparé.</p> <p>Nur zum Anschluss an einen Einzelstromkreis geeignet.</p> <p>Para su uso en circuitos derivados individuales solamente.</p> <p>禁止和其他任何电器设备共用供电回路。必须独立分配一路给该设备</p> <p>LA-3088</p>	<p>For use on individual branch circuit only.</p>
	<p>WARNING Electric shock</p>

! WARNING

Improper installation, alteration, adjustment, service, cleaning, or maintenance could result in property damage, severe injury, or death.

Read and understand the installation, operating and maintenance instructions thoroughly before installing, servicing, or operating this equipment.

! WARNING



To prevent personal injury, death or property damage:
Do not store or use gasoline or other flammable vapors or liquids in the vicinity of this or any other appliance.

! CAUTION



Appliance and accessories may be heavy. To prevent serious injury, **always** use a sufficient number of trained and experienced workers when moving or leveling appliance and handling accessories.

The Alto-Shaam Hot Food Holding Cabinet must be installed in a location that will permit the oven to function for its intended purpose and to allow adequate clearance for ventilation, proper cleaning, and maintenance access.

1. The appliance must be installed on a stable and level surface free of vibration and suitably strong enough to support the combined weights of the appliance plus the maximum product load weight.
2. **Do not** install this appliance in any area where it may be affected by any adverse conditions such as steam, grease, dripping water, high temperatures, or any other adverse conditions.
3. This appliance must be kept free and clear of any combustible materials.
4. This appliance must be kept free and clear of any obstructions blocking access for maintenance or service.

Emissions testing conducted by Underwriters Laboratories, Inc.® was found to be in compliance with the applicable requirements of NFPA96: 2004 Edition, Par. 4.1.1.2. U.L emissions sampling of grease laden vapor resulted in a total of 0.55 milligrams per cubic meter with no visible smoke and is considered representative of all oven models in the line. Based on these results, hood installation and/or outside venting should not be a requirement in most areas. Verify local codes for locations where more restrictive codes are applicable.

Clearance Requirements

Full perimeter bumper accommodates all clearance requirements.

Weight	1000-BQ2/96	1000-BQ2/128	1000-BQ2/192
Net	322 lbs (146 kg)	370 lbs (168 kg)	618 lbs (280 kg)
Ship	415 lbs (188 kg)	485 lbs (220 kg)	750 lbs (340 kg)

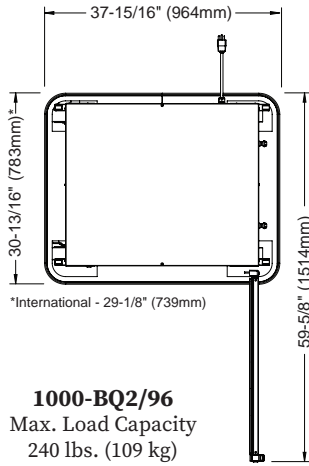

1000-BQ2/96
 Max. Load Capacity
 240 lbs. (109 kg)
 240 qts. (304 lt)

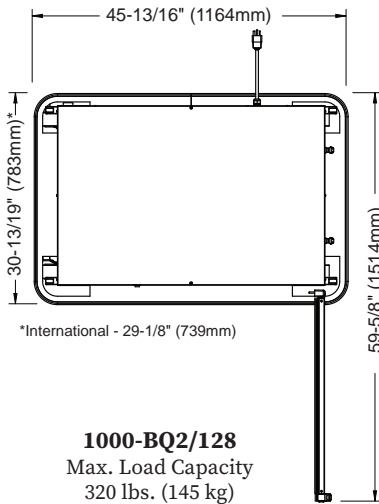
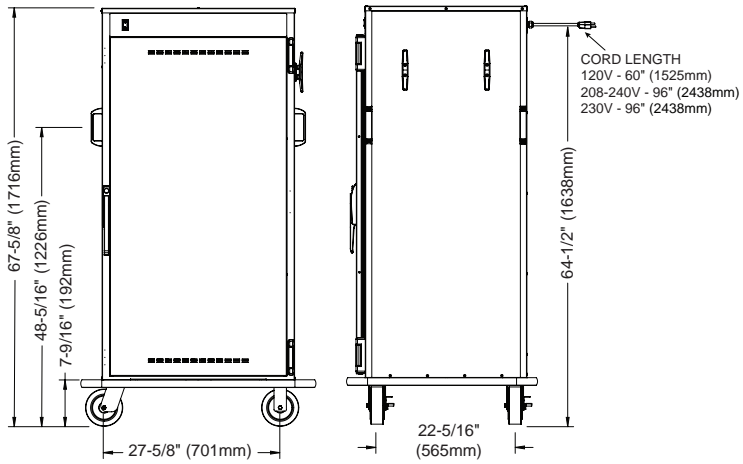

1000-BQ2/128
 Max. Load Capacity
 320 lbs. (145 kg)
 240 qts. (304 lt)

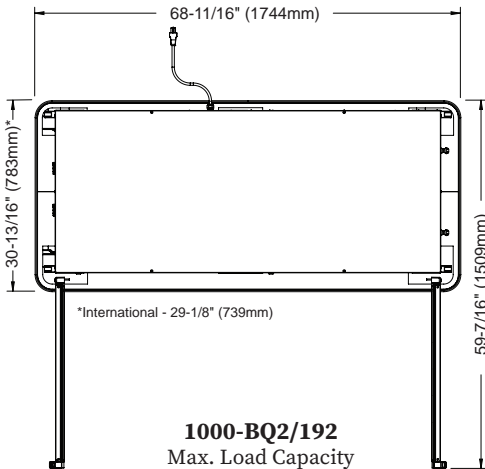
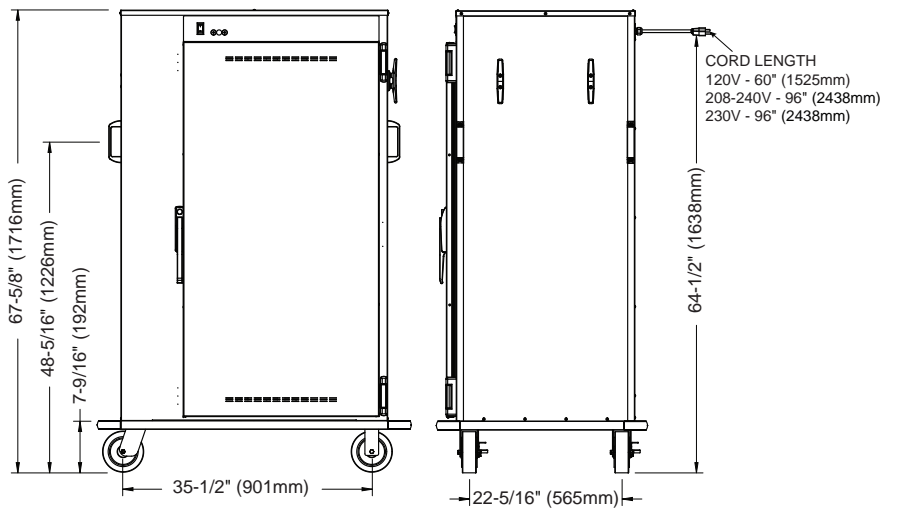

1000-BQ2/192
 Max. Load Capacity
 480 lbs. (218 kg)
 480 qts. (608 lt)

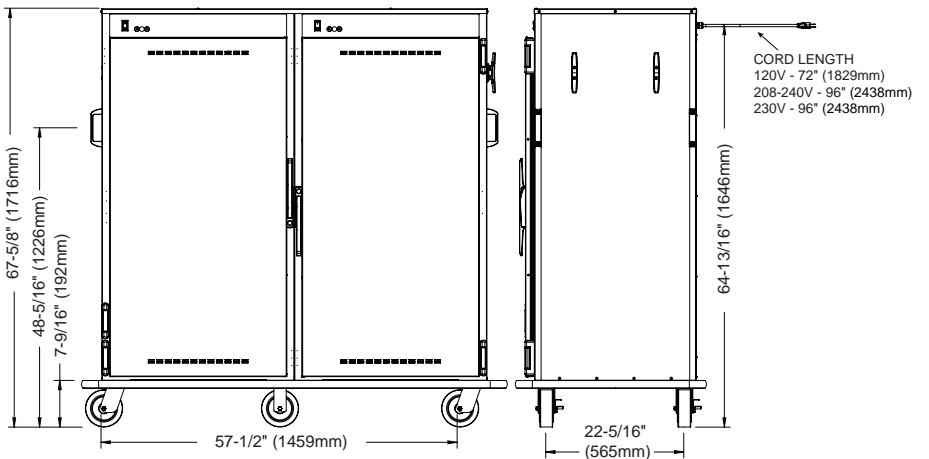
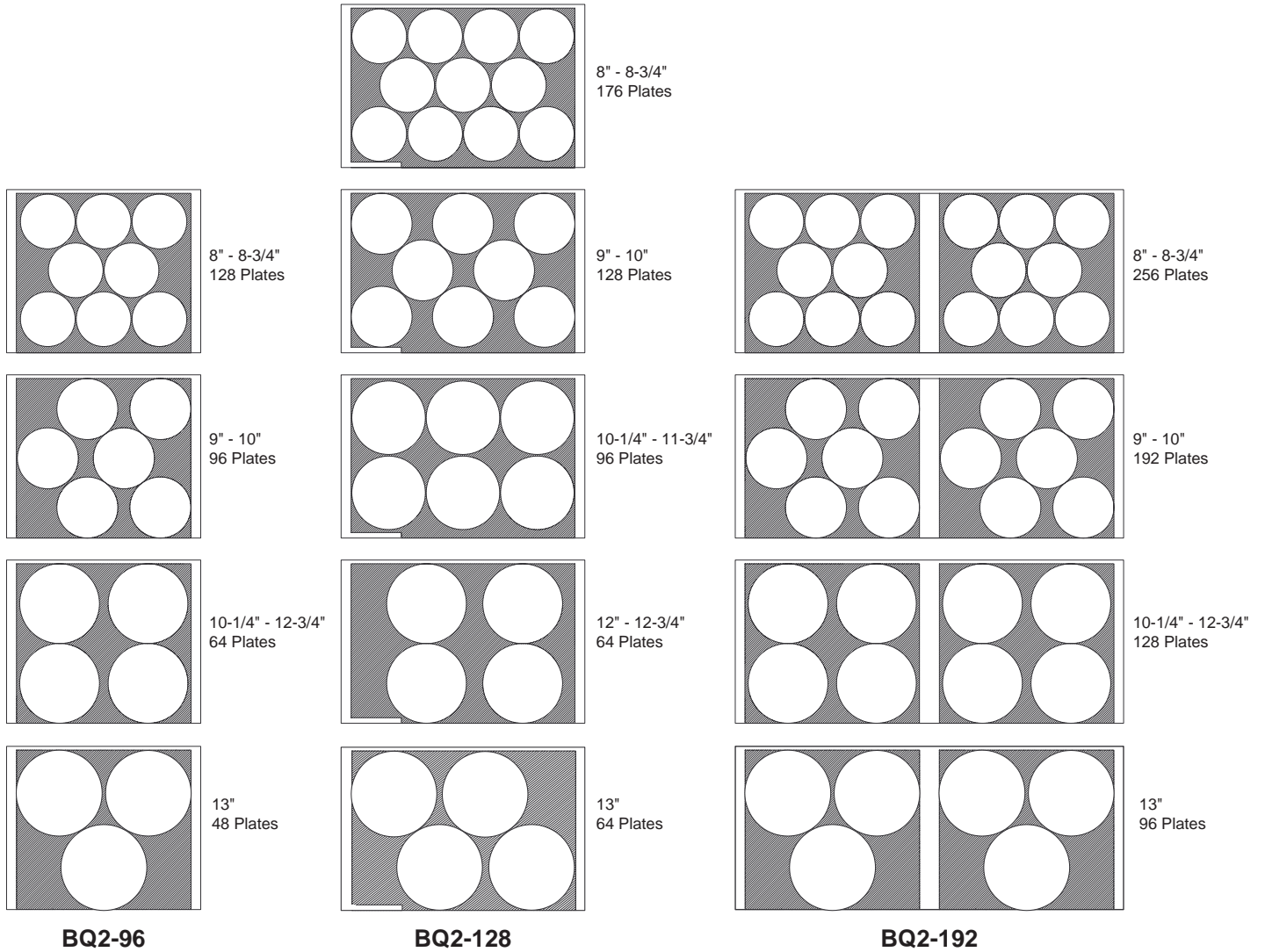
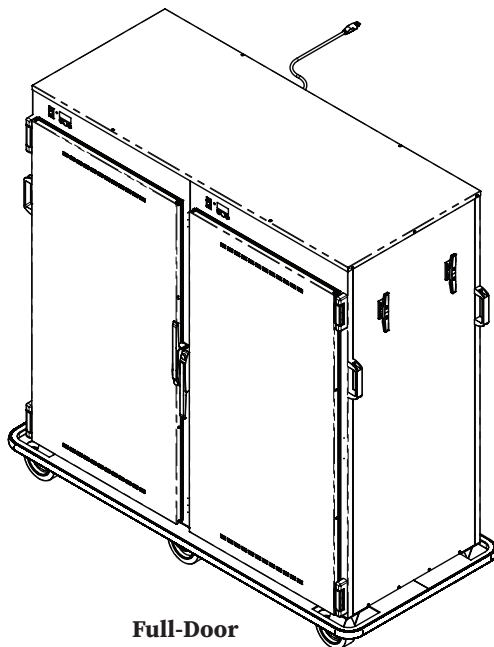

Plate Capacity (16 plates high, 3" plate height)



Accessories			
Plate Carriers, Chrome Plated (each holds four (4) preplated meals)	1000-BQ2/96 Capacity	1000-BQ2/128 Capacity	1000-BQ2/192 Capacity
Uncovered "P" Carriers Plate Diameter: Max. 10" (254mm) Min. 7-3/4" (197mm) Vertical rung spacing: 2-5/8" (67mm)	DC-2868 24 carriers 96 preplated meals	DC-2868 32 carriers 128 preplated meals	DC-2868 48 carriers 192 preplated meals
Covered "C" Carriers Plate Diameter: Max. 9-3/4" (248mm) Min. 7-3/4" (197mm) Vertical clearance between top and bottom carrier: 11-5/8" (295mm)	DC-2869 24 carriers 96 preplated meals	DC-2869 32 carriers 128 preplated meals	DC-2869 48 carriers 192 preplated meals
Uncovered "EP" Carriers Plate Diameter: Max. 12-1/2" (318mm) Min. 9-1/2" (241mm) Vertical rung spacing: 2-5/8" (67mm)	DC-23580 16 carriers 64 preplated meals	DC-23580 24 carriers 96 preplated meals	DC-23580 32 carriers 128 preplated meals
Covered "EC" Carriers Plate Diameter: Max. 12-1/2" (318mm) Min. 9-1/2" (241mm) Vertical clearance between top and bottom carrier: 11-5/8" (295mm)	DC-23676 16 carriers 64 preplated meals	DC-23676 24 carriers 96 preplated meals	DC-23676 32 carriers 128 preplated meals
Shelf Support (2 req'd for each shelf)	1061	1061	1061
Shelf Support Clip (1 req'd for each shelf)	11533	11533	11533
Wire Shelf, Chrome Plated	SH-2835	SH-22727	SH-2835
Door Lock with Key	LK-22567	LK-22567	LK-22567
Security Devices - includes tamper-proof screws, control panel security cover, and door lock	5013816	5013816	5013816
Trailer Hitch (factory installed)	contact factory	contact factory	contact factory
Split Door(s) (factory installed)	5016853	5016929	5016934



Full-Door

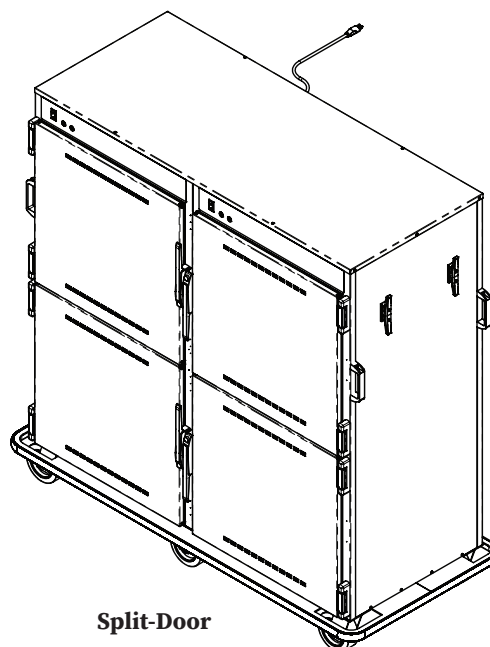



Split-Door

 **WARNING**

 **ELECTRIC SHOCK HAZARD.**

To prevent **SERIOUS INJURY** or **DEATH**, your appliance must be secured to building structure to prevent unintended movement.

 **WARNING**

 To prevent personal injury, death or property damage:

Do not store or use gasoline or other flammable vapors or liquids in the vicinity of this or any other appliance.

A number of adjustments are associated with initial installation and start-up. It is important that these adjustments be conducted by a qualified service technician. Installation and start-up adjustments are the responsibility of the dealer or user. These adjustments include but are not limited to thermostat calibration, door adjustment, leveling, electrical hook-up and installation of optional casters or legs.

1. The appliance must be installed on a stable, non-combustible level horizontal surface. For appliance installed with casters, it is important that the floor surface be level due to the probability of frequent oven repositioning.

Level the appliance from side-to-side and front-to-back with the use of a spirit level.









- NOTE:** Failure to properly level this appliance may result in spills from a semi-liquid product.
2. **DO NOT** install this appliance in any area where it may be affected by any adverse conditions such as steam, grease, dripping water, high temperatures, or any other severely adverse conditions.
 3. This appliance must be kept free and clear of any combustible materials.

Restraint Requirements for Mobile Equipment

Any appliance that is not furnished with a power supply cord but includes a set of casters must be installed with a tether. Adequate means must be provided to limit the movement of this appliance without depending on or transmitting stress to the electrical conduit. The following requirements apply:

1. Casters must be a maximum height of 6" (152mm).
2. Two of the casters must be the locking type.
3. Mobile appliances or appliances on mobile stands must be installed with the a flexible connector secured to the building structure.

A mounting connector for a restraining device is located on the upper back flange of the appliance. A flexible connector is not supplied by nor is it available from the factory.





Electrical Specifications (Wire diagrams are located inside the bonnet of the unit)												
Voltage	Phase	Hz	Amps	kW	 NEMA 5-15P 15A-125v plug	 NEMA 6-15P 15A-250v plug	 NEMA 5-20P 20A-125v plug	 NEMA 5-30P 30A-125v plug	 CEE 7/7 plug rated 250V	 CH2-16P plug rated 250V	 BS1363 plug rated 250V (U.K. only)	 AS/NZS 3112 plug rated 250V
1000-BQ2-96												
120V	1	60	12.5	1.5	✓							
208V 240V	1	60	5.9 6.8	1.2 1.6		✓						
230V	1	50/60	6.5	1.5					✓	✓	✓	✓
1000-BQ2-128												
120V	1	60	17.5	2.1			✓					
208V 240V	1	60	7.7 8.9	1.6 2.1		✓						
230V	1	50/60	8.4	2.0					✓	✓	✓	
1000-BQ2-192												
120V Power switch in low position	1	60	24.0 16.0	2.9 1.9			✓					
120V Power switch in high position	1	60	25.0 max	3.0				✓				
208V 240V	1	60	11.8 13.6	2.5 3.3		✓						
230V	1	50/60	13.0	3.0					✓	✓	✓	✓



- A rating tag is permanently mounted on the appliance. Make sure the power source matches the voltage identified on the rating tag.
- Plug the appliance into a properly grounded receptacle **only**, positioning the appliance so the power supply cord is easily accessible in case of an emergency.
- Arcing will occur when connecting or disconnecting the appliance unless the controller is OFF.

Hard wired models

Hard wired models must be equipped with a country certified external all-pole disconnection switch with sufficient contact separation. Hard wired models that are mounted on casters must have a strain relief device (tether) to prevent strain on the power supply cord. If a power cord is used for the connection of the product an oil resistant cord like H05RN or H07RN or equivalent

NOTICE: Where local codes and CE regulatory requirements apply, appliances must be connected to an electrical circuit that is protected by an external GFCI outlet.

 WARNING	
	To prevent serious injury, death, or property damage: All electrical connections must be made by a qualified and trained service technician in accordance with applicable electrical codes.
	This appliance must be adequately grounded in accordance with local electrical codes or, in the absence of local codes, with the current edition of the National Electrical Code ANSI/NFPA No. 70. In Canada, all electrical connections are to be made in accordance with CSA C22.1, Canadian Electrical Code Part 1 or local codes.
	CE-approved appliances include an equipotential-bonding terminal marked with the symbol shown on the left. Provisions for earthing are to be made in accordance with IEC:2010 60335-1 section 27 or local codes.

 CAUTION	
	Power source must match voltage identified on appliance rating tag. The rating tag provides essential technical information required for any appliance installation, maintenance or repairs. Do not remove, damage or modify the rating tag.

 WARNING	
Improper installation, alteration, adjustment, service, cleaning, or maintenance could result in property damage, severe injury, or death.	
Read and understand the installation, operating and maintenance instructions thoroughly before installing, servicing, or operating this equipment.	

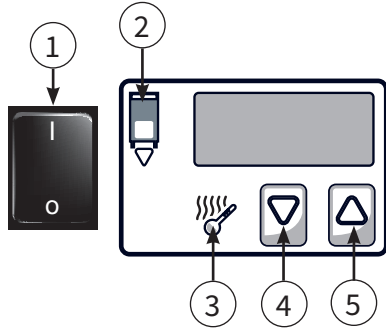

1. Preheat the holding cabinet at 200°F (93°C) for 30 minutes before loading hot food.
 - a) Press the ON/OFF switch ① to the ON (I) position.
To reduce preheat time, rotate the vents inside the door to close them.
 - b) Press the up arrow button ⑤ or the down arrow button ④ until the controller shows 200°F (93°C).
 - Press and release the button to change the holding temperature by one degree.
 - Press and hold the button to change the holding temperature by ten degrees.
 The heat indicator ② illuminates and preheat starts.
2. Wait thirty (30) minutes.
3. Place hot food in the holding cabinet.

WARNING

Only food which has been heated to an internal temperature of 140°F to 160°F (60°C to 71°C) should be placed in the holding cabinet.

4. Select at least one food item in every pan and insert a food thermometer into the center to check internal temperature. Heat any food items which are below the minimum temperature before placing them in the holding cabinet.
5. Close the holding cabinet door securely.
6. Press the down arrow button ④ until the controller shows 160°F (71°C).
 - a) Press and release the button to change the holding temperature by one degree.
 - b) Press and hold the button to change the holding temperature by ten degrees.

How to Display Set-Point or Actual Holding Temperature

NOTE: The factory default is the set-point holding temperature.

Press and hold the temperature display button ③ and the up arrow button ⑤ simultaneously, for five (5) seconds.

The controller shows "ACT" for Actual compartment temperature, or "SET" for the Set-point holding temperature, and then the selected temperature.

NOTE: Press the temperature display button ③ at any time to temporarily display the alternate temperature.

How to Change Controller from Fahrenheit to Celsius

NOTE: The factory default is Fahrenheit.

Press and hold the temperature display button ③ and the down arrow button ④ simultaneously, for five (5) seconds.

The controller shows °C for Celsius or °F for Fahrenheit, then the temperature at the selected setting.

NOTE: The last selected setting is retained by the control board if there is a power failure.

SureTemp™ Heat Recovery

The patented SureTemp™ heat recovery system in this appliance will immediately compensate for any loss of heat when the door is opened. In order to maintain a more consistent compartment temperature, the control will automatically apply heat to the appliance's interior while the door is open and for a short time after the door is closed. If the door remains open for more than three minutes, the control will sound three rapid beeps every ten seconds until the door is closed.

Holding Procedure

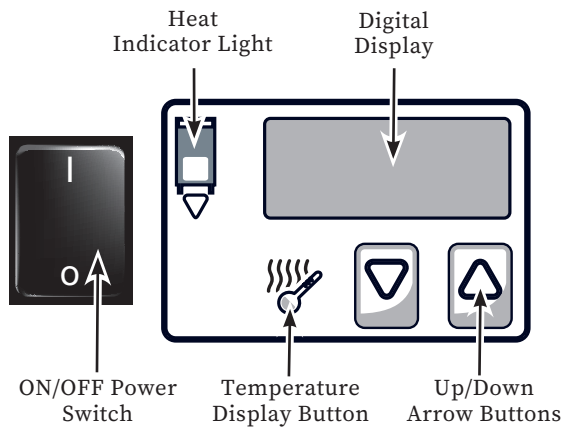

1. Preheat at 200°F for 30 minutes.

Allow a minimum of 30 minutes for preheating before loading the banquet cart with product.

2. Load the cart with hot food only.

The purpose of the banquet cart is to maintain hot food at proper serving temperature. Only hot food should be placed into the banquet cart. Before loading the cart with food, use a food thermometer to make certain all products have reached an internal temperature range of 140°F to 160°F (60°C to 71°C). Any food product not within the proper temperature range should be heated before loading into the banquet cart. For best results, use a Halo Heat Low Temperature Cooking and Holding Oven set at 250°F to 275°F (121°C to 135°C), or a Combitherm oven, to bring the product within the correct temperature range.

3. Load covered plates or carriers into the banquet cart.

After the food has reached proper serving temperature:

- Use **heated** plates only.
- Load each series of four (4) plates into the banquet cart as soon as assembled and as quickly as possible to retain maximum heat.
- Load the plates in the upper section of the banquet cart first.
- Securely close the door(s) of the banquet cart after loading.

4. Reset the thermostat to desired temperature.

After the cart has been completely filled with product, check to make certain the doors are securely closed, and reset the thermostat to the desired holding temperature or the suggested 180°F (82°C).

The proper temperature range for the products being held, and whether or not to open or close the door vents, will depend on the type and quantity of product. When holding food for prolonged periods, it is advisable to periodically check the internal temperature of each item with a food thermometer to assure maintenance of the proper temperature range of 140°F to 160°F (60°C to 71°C).

5. Unload covered plates, trays or plate carriers as needed.

- Unload the items from the lower section of the cart first, and work up toward the top of the cart.
- Securely close the door(s) of the cart after each product removal.

⚠ WARNING



To prevent serious personal injury, death, or property damage:

Do not steam clean, hose down or flood the interior or exterior with water or liquid solution of any kind. **Do not** use water jet to clean. Failure to observe this precaution will void the warranty.

⚠ WARNING

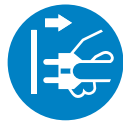

To prevent serious injury, death, or property damage, **always** disconnect the appliance from the power source before cleaning or servicing.

How to Clean the Holding Cabinet

1. Disconnect the appliance from the power source. Let the appliance cool.
 2. After the appliance has cooled, remove the cover or wrap, and store unused products under refrigeration.
 3. Remove all the detachable items such as plate carriers, wire shelves, side racks, and any drip pans. Clean these items separately.
 4. Clean the interior with a damp cloth or sponge with any good commercial detergent.
- NOTICE:** Avoid the use of abrasive cleaning compounds, chloride-based cleaners, or cleaners containing quaternary salts. Never use hydrochloric acid (muriatic acid) on stainless steel.
5. Spray heavily soiled areas with a water soluble degreaser and let stand for 10 minutes, then remove soil with a plastic scouring pad.
 6. Wipe the control panel, door vents, door handles, and door gaskets.
 7. Rinse surfaces by wiping with sponge and clean warm water.
 8. Remove excess water with sponge and wipe dry with a clean cloth or air dry. Leave door open until interior is completely dry.
 9. Wipe the interior with a sanitizing solution that is approved for use on stainless steel food contact surfaces.
 10. Re-install the side racks/pan slides, drip tray, drip pan and shelves.
- NOTE:** Shelves must be installed with the curved end up and toward the back of the compartment.
11. Spray a clean cloth with a cleaning solution approved for stainless steel and wipe the exterior of the cabinet.
 12. Clean door glass with glass cleaner or distilled vinegar.
 13. Cart Cleaning --
Remove cart to a wash area and use any mild cleaning detergent and warm water. Hand wipe all framing, slides, drip pan, and base. Thoroughly clean debris from the casters. A spray hose can be used for cart cleaning. Rinse detergent solution off with warm water. Wipe or spray with a sanitizing solution designed for use on metal and vinyl food contact surfaces. Allow cart to air dry.
- Always follow appropriate state or local health (hygiene) regulations regarding all applicable cleaning and sanitation requirements for food service equipment.

Cleaning and Preventative Maintenance

Preventative Maintenance Checklist	
Daily	
	Perform daily cavity cleaning as stated in the cleaning section of this manual
	Clean out the front drip tray
Monthly	
	Inspect door gasket
	Inspect door window gasket
	Inspect cavity door vent slides for proper operation
	Inspect side racks, shelves and shelf supports to ensure nothing is damaged or in need of replacement
Every 12 months (Inspection by a factory authorized technician)	
	Open control area and inspect/tighten all wiring
	Inspect all electrical components
	Test elements for electrical short to ground. Replace/repair as needed.
	Visually inspect the cavity for structural integrity
	Inspect door gasket. Replace if needed.
	Visually inspect any door handles and hinges. Replace/repair as needed.
	Remove any loose handle and hinge screws. Then properly secure the screws using Loctite.
	Inspect and test control and control functions
	Inspect casters. Repair/replace as needed.
	Inspect perimeter bumper. Repair/replace as needed.
	Inspect power cord. Tighten cord connection inside the appliance control area
	Perform cavity temperature calibration per manufacturer's recommended calibration procedures
	Check site voltage
	Confirm proper current draw of heating pads

⚠ WARNING

Electric shock hazard.

Perform lockout/tagout procedures before cleaning or servicing this appliance.



This section is provided for the assistance of qualified and trained service technicians only and is not intended for use by untrained or unauthorized service personnel. Failure to observe this precaution may void the warranty.

Thermostat Accuracy

The electronic thermostat is a precise instrument and is designed to offer trouble free service. If you suspect the temperature inside the holding compartment does not match the temperature indicated on the digital display, follow the instructions listed below.

1. Make sure the appliance voltage matches the power source.
2. Verify the temperature inside the holding compartment with a qualify thermal indicator.
 - A. With the exception of the wire shelves, completely empty the holding compartment.
 - B. Make sure the air temperature sensor, located inside the holding cabinet is completely clean.
 - C. Suspend a quality thermometer from the center of the holding compartment.
 - D. Allow the temperature set on the electronic thermostat to stabilize for a minimum of one hour before comparing the digital display with the reading on the thermal indicator.

Do not open the cabinet door(s) during the temperature stabilization period.

If the reading on the thermometer does not match the temperature on the controller, the air sensor may be faulty.

How to verify sensor integrity

Place the sensor in ice water. Test with an ohmmeter set to the ohm scale.

Air sensor	1000 ohms \pm 20
------------	--------------------



















If the reading is more than \pm 20 ohms, replace sensor.

Always verify that the circuit breaker is turned to the On position and your appliance is receiving power **before** calling your authorized Alto-Shaam Service Agent.

Troubleshooting

Code	Description	Possible Causes
E-10	Cavity air sensor shorted	Cavity air sensor reading < 5°F (-15°C). Verify sensor integrity.
E-11	Cavity air sensor open	Cavity air sensor reading > 517°F (269°C). Verify sensor integrity.
E-20	Product probe is shorted <i>Oven will cook in time only</i>	Product probe reading < 5°F (-15°C). Verify sensor integrity.
E-21	Product probe is open <i>Oven will cook in time only</i>	Product Probe reading > 517°F (269°C). Verify sensor integrity.
E-30	Under temperature	Unit has been more than 25°F (14°C) below set point for longer than 90 minutes.
E-31	Over temperature	Unit has been more than 60°F (33°C) above the maximum set-point for longer than 3 minutes. Holding Cabinets with this error code are more than 145°F (81°C) above the maximum set-point.
E-32	Safety switch open (Aux hi-limit switch)	Contact factory.
E-38	Internal software error	Contact factory.
E-39	Sensor error	Contact factory.
E-50	Temp. measurement error	Contact factory.
E-51	Temp. measurement error	Contact factory.
E-60	Real time clock error	Data set to factory default. Ensure that date and time are correct if applicable.
E-61	Real time clock error	Contact factory.
E-64	Clock is not oscillating	Contact factory.
E-70	Configuration connector error (DIP switch)	Refer to the electrical schematic and ensure dip switches on the control match the settings called out on the schematic. If the dip switch settings are correct, according to the schematic, replace the control.
E-78	Voltage low	Voltage below 90 VAC on a 125 VAC unit, or below 190 VAC on a 208-240 VAC unit. Adjust DC voltage. See "How to Adjust DC Voltage" in this manual.
E-79	Voltage high	Voltage over 135 VAC on a 125 VAC unit, or over 250 VAC on a 208-240 VAC unit. Adjust DC voltage. See "How to Adjust DC Voltage" in this manual.
E-80	EEPROM Error	Ensure that all temperatures and times are properly set. Contact factory if problem persists.
E-81	EEPROM Error	Contact factory.
E-82	EEPROM Error	Contact factory.
E-83	EEPROM Error	Contact factory.
E-85	EEPROM Error	All timers, if previously on, are now off. Possible bad EEPROM.
E-86	EEPROM Error	Stored HACCP memory corrupted. HACCP Address reset to 1. Possible bad EEPROM. Contact factory if problem persists.
E-87	EEPROM Error	Stored offsets corrupted. Offsets reset to 0. Control may need a recalibration. Possible bad EEPROM. Contact factory if problem persists.
E-88	EEPROM Error	All timer set-points are reset to 1 minute. Timers, if previously on, are now off. Possible bad EEPROM.
E-90	Button stuck	A button has been held down for > 60 seconds. Adjust control. Error will reset when the problem has been resolved.
E-91	Input failure	Contact factory.
E-dS	Datakey error	Datakey digital signature incompatible. Cycle power, and install compatible Datakey if error persists.
E-dT	Datakey error	Datakey incompatible with control. Install compatible Datakey.
E-dU	Datakey unplugged	Install Datakey and cycle power to control to clear error.
dLto	Datalogger has timed out	Cycle power. Contact factory if error persists.
dLSD	Micro SD card not plugged in	Plug in SD card and cycle power. Contact factory if error persists.
NOTE: If in doubt, always cycle the power to the control and contact factory if the problem persists.		

For the most current schematics, use the QR code or click link.

<p>77401 1000-BQ2/96 120V 60Hz</p>		
<p>77402 1000-BQ2/96 208-240V 1Ph 60Hz</p>		
<p>77403 1000-BQ2/96 230V 1Ph 50/60Hz</p>		
<p>77404 1000-BQ2/128 120V 60Hz</p>		
<p>77405 1000-BQ2/128 208-240V 1Ph 60Hz</p>		
<p>77406 1000-BQ2/128 230V 1Ph 50/60Hz</p>		
<p>77407 1000-BQ2/192 120V 60Hz</p>		
<p>77408 1000-BQ2/192 208-240V 1Ph 60Hz</p>		
<p>77409 1000-BQ2/192 230V 1Ph 50/60Hz</p>		

Warranty

Introduction

Alto-Shaam, Inc. warrants to the original purchaser only, that any original part found to be defective in material or workmanship will be replaced with a new or rebuilt part at Alto-Shaam's option, subject to provisions hereinafter stated.

Warranty Period

The original parts warranty period is as follows:

- For all other original parts, one (1) year from the date of installation of appliance or fifteen (15) months from the shipping date, whichever occurs first.
 - The labor warranty period is one (1) year from the date of installation or fifteen (15) months from the shipping date, whichever occurs first.
 - Alto-Shaam will bear normal labor charges performed during standard business hours, excluding overtime, holiday rates or any additional fees.
 - For the refrigeration compressor, if installed, the warranty period is five (5) years from the date of original installation of the appliance.
 - For heating elements on Halo Heat® Cook and Hold ovens, the warranty period is for as long as the original owner owns the oven. This warranty period applies to units sold after 2/1/2009 and excludes holding-only ovens.
 - To be valid, a warranty claim must be asserted during the applicable warranty period. This warranty is not transferable.
-

Exclusions

This warranty does not apply to:

- Calibration.
 - Replacement of light bulbs, rubber gaskets, grease filters, air filters, racks, jet plates, and/or the replacement of glass due to damage of any kind.
 - Equipment damage caused by accident, shipping, improper installation or alteration.
 - Equipment used under conditions of abuse, misuse, carelessness or abnormal conditions, including but not limited to, equipment subjected to harsh or inappropriate chemicals, including but not limited to, compounds containing chloride or quaternary salts, poor water quality, or equipment with missing or altered serial numbers.
 - Equipment damage caused by use of any cleaning agents other than those recommended by Alto-Shaam, including but not limited to damage due to chlorine or other harmful chemicals.
 - Any losses or damage resulting from malfunction, including loss of food product, revenue, or consequential or incidental damages of any kind.
 - Equipment modified in any manner from original model, substitution of parts other than factory authorized parts, unauthorized removal of any parts including legs, or unauthorized addition of any parts.
 - Equipment damage incurred as a direct result of poor water quality*, inadequate maintenance of steam generators and/or surfaces affected by water. Water quality and required maintenance of steam generating equipment is the responsibility of the owner/operator.
 - Equipment damage incurred as a result of not following the required maintenance schedule published in the manuals for the equipment.
-

Conclusion

This warranty is exclusive and is in lieu of all other warranties, express or implied, including the implied warranties of merchantability and fitness for a particular purpose. No person except an officer of Alto-Shaam, Inc. is authorized to modify this warranty or to incur on behalf of Alto-Shaam any other obligation or liability in connection with Alto-Shaam equipment.

**Refer to the product spec sheet for water quality standards.*