



1000-MR2-1

1000-MR2-1
1000-MR2-2



1000-MR2-2

- **Installation**
- **Operation**
- **Maintenance**

W164 N9221 Water Street • P.O. Box 450
Menomonee Falls, Wisconsin 53052-0450 U.S.A.

PHONE: 262.251.3800 • 800.558.8744 U.S.A. / CANADA
FAX: 262.251.7067 • 800.329.8744 U.S.A. ONLY
www.alto-shaam.com



Consult instructions
for operation and use.



Table of Contents

Delivery	3
Transportation Damage and Claims.....	4
Unpacking	5
Safety Procedures.....	6
Installation	8
Dimensions.....	9
Electrical Connections	11
Operation	12
Food Safety	17
Cleaning and Preventative Maintenance	18
Troubleshooting.....	20
Service.....	21
Limited Warranty	28

This Alto-Shaam appliance has been thoroughly tested and inspected to ensure only the highest quality appliance is provided. Upon receipt, check for any possible shipping damage and report it at once to the delivering carrier. See Transportation Damage and Claims section located in this manual.

This appliance, including unattached items and accessories, may be delivered in one or more packages. Ensure all standard items and options have been received with each appliance as ordered. Save all the information packed with the appliance. Register the appliance online at www.alto-shaam.com/en/support/warranty-registration to ensure prompt service in the event of a warranty parts and labor claim.

This manual must be read and understood by all people using or installing the appliance. Contact the Alto-Shaam Tech Team Service Department if you have any questions concerning installation, operation, or maintenance.

1-800-558-8744; servicedept@alto-shaam.com

The serial number is required for all inquiries.
 Always include both model and serial number(s) in any correspondence regarding the appliance.

Model: _____

Serial number: _____

Purchased from: _____

Date installed: _____ **Voltage:** _____

CAUTION

Appliance and accessories may be heavy. To prevent serious injury, **always** use a sufficient number of trained and experienced workers when moving or leveling appliance and handling accessories.

Environmental Conditions

Operational Environmental Conditions

- Before use, appliance must acclimate to room temperature in the environment it is placed – 24 hours is recommended.
- Ambient temperature range of 60°F to 110°F (16°C to 43°C).
- Relative humidity of less than 95% non-condensation.
- Atmospheric pressure range of 50kPa to 106kPa.

Climate 4: Tests in accordance with Clauses 10, 11 and 13 are performed at an ambient temperature of 32 °C ± 2 °C

Transportation Damage and Claims



All Alto-Shaam equipment is sold Free on Board (F.O.B.) shipping point, and when accepted by the carrier, such shipments become the property of the consignee.

Should damage occur in shipment, do not put the appliance into service until the damage has been inspected by an authorized Alto-Shaam service provider.

Shipping damages are a matter between the carrier and the consignee. In such cases, the carrier is assumed to be responsible for the safe delivery of the merchandise, unless negligence can be established on the part of the shipper.

1. Make an immediate inspection while the appliance is still in the truck or immediately after it is moved to the receiving area. Do not wait until after the appliance is moved to a storage area.
2. Do not sign a delivery receipt or a freight bill until a proper count has been made and inspection of all appliances are received.

3. Note all damage to packages directly on the carrier's delivery receipt.
4. Make certain the driver signs the delivery receipt. If the driver refuses to sign, make a notation of this refusal on the receipt.
5. If the driver refuses to allow inspection, write the following on the delivery receipt: **Driver refuses to allow inspection of containers for visible damage.**
6. Contact the carrier's office immediately upon finding damage, and request an inspection. Mail a written confirmation to the carrier's office with the time, date, and the person called.
7. Save any packages and packing material for further inspection by the carrier.
8. Promptly file a written claim with the carrier and attach copies of all supporting paperwork.

Alto-Shaam will continue our policy of assisting our customers in collecting claims which have been properly filed and actively pursued. Alto-Shaam cannot, however, file any damage claims, assume the responsibility of any claims, or accept deductions in payment for such claims.

Record the model and serial number of the appliance for easy reference. Always refer to both model and serial number in any contact with Alto-Shaam regarding this appliance.

Model: _____

Serial Number: _____

Date Installed: _____

Voltage: _____

Purchased From: _____



Alto-Shaam has established a twenty-four hour emergency service call center to offer immediate customer access to a local authorized service agency outside of standard business hours. The emergency service access is provided exclusively for Alto-Shaam equipment and is available throughout the United States through the use of Alto-Shaam's toll-free number. Emergency service access is available seven days a week including holidays.

- Carefully remove the appliance from the carton or crate.

NOTE: Do not discard the carton and other packaging material until you have inspected the appliance for hidden damage and tested it for proper operation.

Do not discard this manual. This manual is considered to be part of the appliance and is to be provided to the owner or manager of the business or to the person responsible for training operators. Additional manuals are available from the manufacturer.

- Read all instructions in this manual carefully before installing this appliance, using the appliance or performing routine maintenance. Following procedures other than those indicated in this guide to use and clean the appliance is considered inappropriate and may cause damage, injury or fatal accidents, in addition to voiding the warranty and relieving Alto-Shaam of all liability.
- Remove all protective plastic film, packaging materials, and accessories from the appliance before connecting electrical power. Store any accessories in a convenient place for future use.

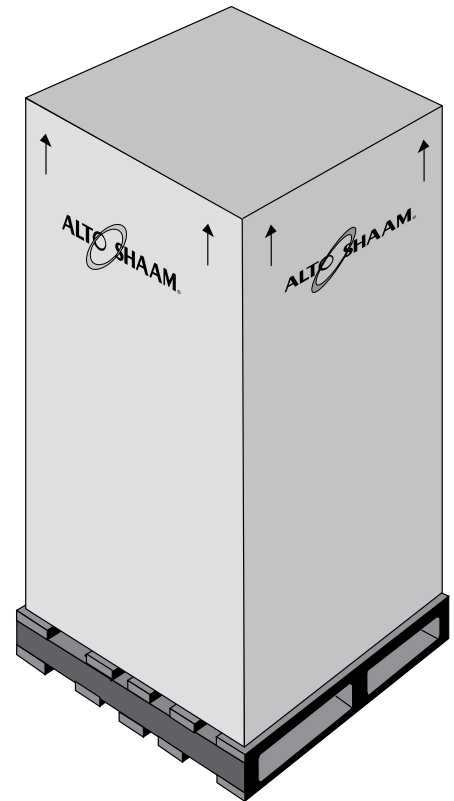

Safety Procedures

- The appliance is intended to cook, hold or process foods for the purpose of human consumption. No other use for this appliance is authorized and is therefore considered dangerous. The appliance must not be used to cook food containing flammable materials (such as food with alcohol). Substances with a low flash point can ignite spontaneously and cause a fire.
- The appliance is intended for use in commercial establishments where all operators are familiar with the purpose, limitations, and associated hazards of this appliance. Operating instructions and warnings must be read and understood by all operators and users. Alto-Shaam recommends regular staff training to avoid the risk of accident or damage to the appliance. Operators must also receive regular safety instructions.
- Any troubleshooting guides, component views, and parts lists included in this manual are for general reference only and are intended for use by qualified and trained technicians.
- This manual should be considered a permanent part of this appliance. This manual and all supplied instructions, diagrams, schematics, parts lists, notices, and labels must remain with the appliance if the item is sold or moved to another location.

NOTICE: For equipment delivered for use in any location regulated by the following directive: 2012/95/EC WEEE



Do not dispose of electrical or electronic equipment with other municipal waste.

Knowledge of proper procedures is essential to the safe operation of electrically and/or gas energized equipment. The following signal words and symbols may be used throughout this manual.

DANGER

Indicates a hazardous situation that, if not avoided, will result in death or serious injury.

WARNING

Indicates a hazardous situation that, if not avoided, could result in death or serious injury.

CAUTION

Indicates a hazardous situation that, if not avoided, could result in minor or moderate injury.

NOTICE: Indicates information considered important, but not hazard-related (e.g., messages relating to property damage).



Indicates that referral to operating instructions is a mandatory action. If not followed the operator could suffer personal injury.



Indicates that referral to operating instructions is recommended to understand operation of equipment.

- To prevent serious injury, death or property damage, the appliance should be inspected and serviced at least every twelve (12) months by an authorized service partner or trained technician.
- **Only** allow an authorized service partner or trained technician to service or to repair the appliance. Installation or repairs that are not performed by an authorized service partner or trained technician, or the use of non-factory authorized parts will void the warranty and relieve Alto-Shaam of all liability.
- When working on this appliance, observe precautions in the literature, on tags, on labels attached to or shipped with the appliance and other safety precautions that may apply.
- If the appliance is installed on casters, freedom of movement of the appliance must be restricted so that utility connections (including gas, water, and electricity) cannot be damaged when the appliance is moved. If the appliance is moved, ensure that all utility connections are properly disconnected. If the appliance is returned to its original position, ensure that retention devices and utility connections are properly connected.
- **Only** use the appliance when it is stationary. Mobile appliance racks, mobile plate racks, transport trolleys, and appliances on casters can tip over when being moved over an uneven floor or threshold and cause serious injury.
- **Always** apply caster brakes on mobile appliances or accessories when these are not being moved. These items could move or roll on uneven floors and cause property damage or serious injury.

WARNING

This appliance is not intended for use by persons (including children) with reduced physical, sensory or mental capabilities, or lack of experience and knowledge, unless they have been given supervision concerning use of the appliance by person responsible for their safety.

Children should be supervised to ensure that they do not play with the appliance.

Installation

WARNING

Improper installation, alteration, adjustment, service, cleaning, or maintenance could result in property damage, severe injury, or death.

Read and understand the installation, operating and maintenance instructions thoroughly before installing, servicing, or operating this equipment.

Position the refrigerated cart to allow sufficient air ventilation through the condensing unit(s).

Avoid installing the chiller immediately adjacent to fryers, charbroilers, or any other equipment producing grease laden air; heat producing equipment such as ovens and ranges; and steam discharging equipment such as steamer ovens and kettles. Do not locate the refrigerated cart in direct sunlight.

Installation

Prior to moving the refrigerated cart to the installation site, check the dimensions of doors, passageways, and ceiling heights in the areas through which the cabinet must be moved. Also check the turning radius if the cabinet must be moved around an existing structure. The use of a fork lift or pallet lift truck is required for moving and leveling most refrigerated cart models.

NOTE: In certain instances, it may be necessary to remove doors and door hardware to negotiate tight spaces.

This unit must be placed on a level floor to ensure the automatic door closing and correct draining of condensate.

WARNING – Do not store explosive substances such as aerosol cans with a flammable propellant inside the appliance.

WARNING – Keep clear of obstruction all ventilation openings in the appliance enclosure or in the structure for building-in.

WARNING – Do not use mechanical devices or other means to accelerate the defrosting process, other than those recommended by the manufacturer.

WARNING – Do not damage the refrigerant circuit.

WARNING – Do not use electrical appliances inside the food storage compartments of the appliance, unless they are of the type recommended by the manufacturer.

CAUTION



Appliance and accessories may be heavy. To prevent serious injury, **always** use a sufficient number of trained and experienced workers when moving or leveling appliance and handling accessories.

Clearance Requirements

Full perimeter bumper accommodates all clearance requirements.

Appliance should not be tipped on its side.

If tipped, unit must stand in the upright position for a minimum of 12 hours before operating. Tipping will damage the appliance and void the warranty if not allowed to "rest".

If unit must be tipped, use extreme care. Block casters to prevent unit from rolling while lowering or lifting.

1000-MR2-1

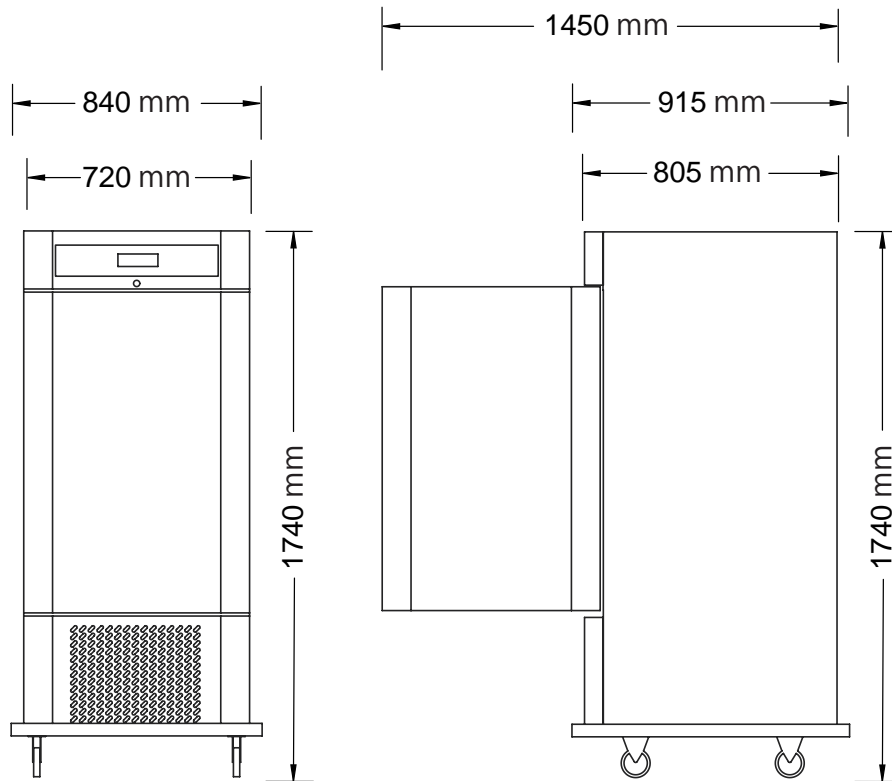

Weight	
Net	Ship
130kg	Standard pallet: 155kg Wood crate: 191kg
Shipping dimensions: (L x W x H) 970mm x 890mm x 1920mm	

Product/Pan Capacity
131 kg maximum
Volume maximum: 228 liters
Gastronorm 1/1: Twenty-four (24) 530 mm x 325 mm x 65 mm

Refrigeration
270g R134a refrigerant Refrigeration duty of 1584 Btu/h Heat of rejection 2060btu/h

Drainage
Evaporator pan — No installation required

Dimensions

1000-MR2-2

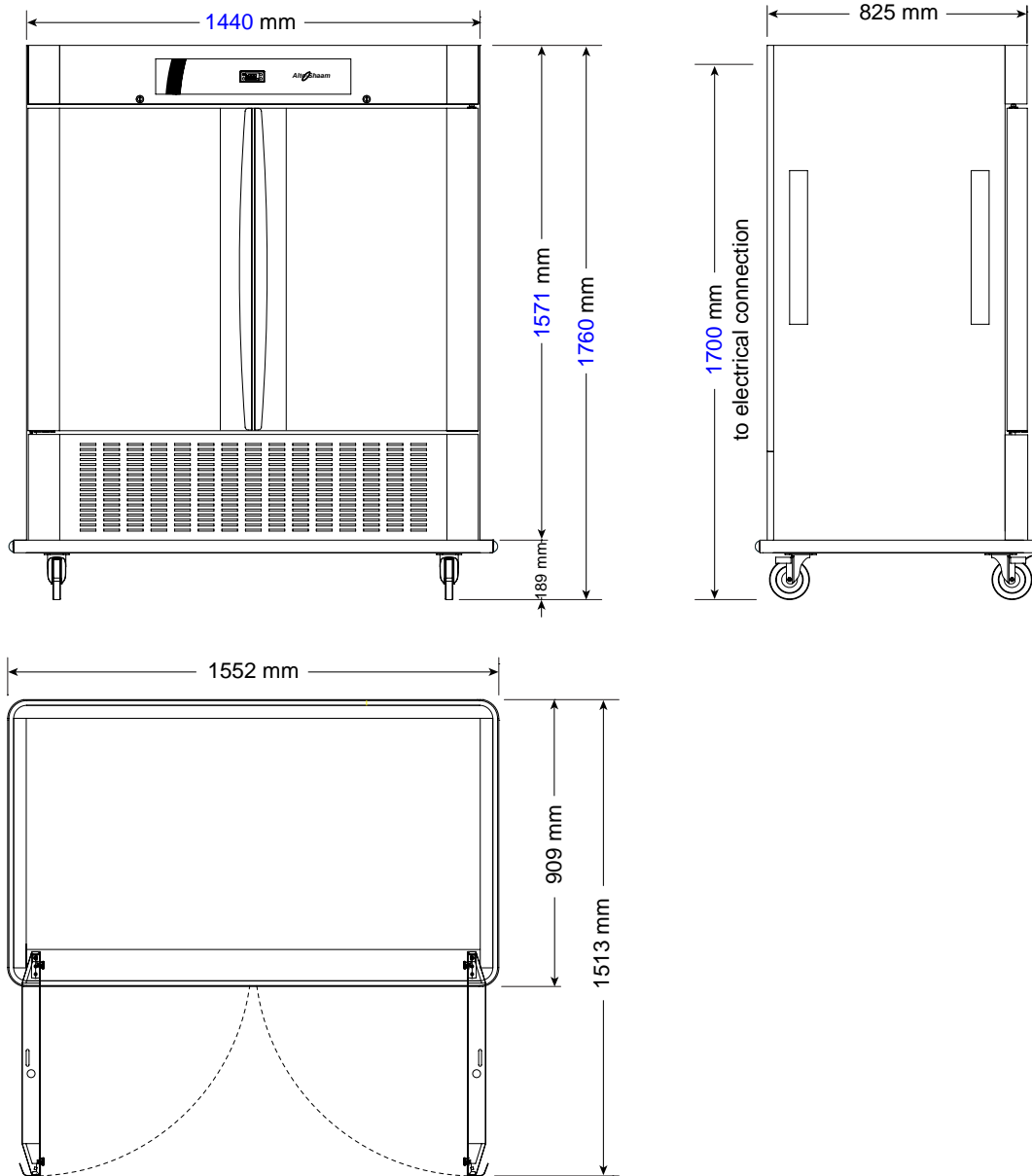

Weight	
Net: 180 kg	Ship: 230 kg
Carton dimensions: (L x W x H) 1605 mm x 975 mm x 1895 mm	



Refrigeration
370g R134a refrigerant Refrigeration duty of 2170 Btu/h Heat of rejection 3380 Btu/h



Product/Pan Capacity
181 kg maximum Volume maximum: 456 liters
Gastronorm 1/1: Fourty-eight (48) 530 mm x 325 mm x 65 mm

Drainage
Evaporator pan — No installation required

Electrical Connections

This product is supplied with a moulded 13 Amp plug which needs a suitable socket. This cabinet should not be used outside and should be used in a dry environment. The plug needs to be accessible once the equipment is placed in its final position. Should the plug need changing, this must be done by a qualified person.

Electrical - 1000-MR2-1						
V	Ph	Hz	A	kW		
220	1	50/60	2.5	.3		SASO-2203 13A Plug
						CEE 7/7 Plug rated 250v

Electrical - 1000-MR2-2						
V	Ph	Hz	A	kW		
220	1	50/60	4	.65		SASO-2203 13A Plug
						CEE 7/7 Plug rated 250v

If the supply cord is damaged, it must be replaced by the manufacturer or its service agent or a similarly qualified person in order to avoid a hazard.

After connecting electric power to the appliance, no other adjustments are needed for operation.

⚠ CAUTION



Power source must match voltage identified on appliance rating tag. The rating tag provides essential technical information required for any appliance installation, maintenance or repairs. Do not remove, damage or modify the rating tag.

⚠ WARNING



To prevent serious injury, death, or property damage:
All electrical connections must be made by a qualified and trained service technician in accordance with applicable electrical codes.



This appliance must be adequately grounded in accordance with local electrical codes or, in the absence of local codes, with the current edition of the National Electrical Code ANSI/NFPA No. 70. In Canada, all electrical connections are to be made in accordance with CSA C22.1, Canadian Electrical Code Part 1 or local codes.



CE-approved appliances include an equipotential-bonding terminal marked with the symbol shown on the left. Provisions for earthing are to be made in accordance with IEC:2010 60335-1 section 27 or local codes.

WARNING



To prevent SERIOUS INJURY, DEATH or PROPERTY DAMAGE:
All electrical connections must be made by a qualified and trained service technician in accordance with applicable electrical codes.

Operation

1. Display



2. Display Legend

LED		BUTTONS	
	Thermostat output		Enter / Confirm
	Fan output		Decrease / Lights
	Defrost output		Increase / Eco mode
	Eco mode activated		Exit / Standby
	Keyboard unlocked (*)		Manual defrost

(*) LED off = locked, LED on = unlocked.
LED will blink to notify the key detection.

3. Operation

Unlock	Standby	Eco mode	Manual defrost	Manual lights

4. Menu

NAVIGATION and VALUE DISPLAY	ITEM MODIFICATION
<ul style="list-style-type: none"> Menu item Display value or enter in submenu + Next item - Previous item x Exit 	<ul style="list-style-type: none"> Increase Decrease Save and go to following item To exit without saving, press the key or wait 10 sec

MAIN MENU	INFO SUBMENU ITEMS
SP Display and modify main setpoint	T1 Temperature measured by probe T1
IISP ¹⁾ Display and modify alternative setpoint	T2 Temperature measured by probe T2
TIM Display and modify system minutes/hours (MIN, HRS)	T3 Temperature measured by probe T3
TAC ²⁾ Display and modify start and end time for function activation (Eco mode or light)	THI Maximum temperature measured
INF Info submenu	TLO Minimum temperature measured
1) only if IISM different from NON	CND* Compressor working weeks
2) only if IISM=RTC or LSM=RTC	PSD Enter Password for parameters submenu access
	* Only if ACC different from 0

5. Parameters Submenu

To enter in parameters submenu, enter PSD = 12 on info submenu.

<parameters table: SPL, SPH, etc...>

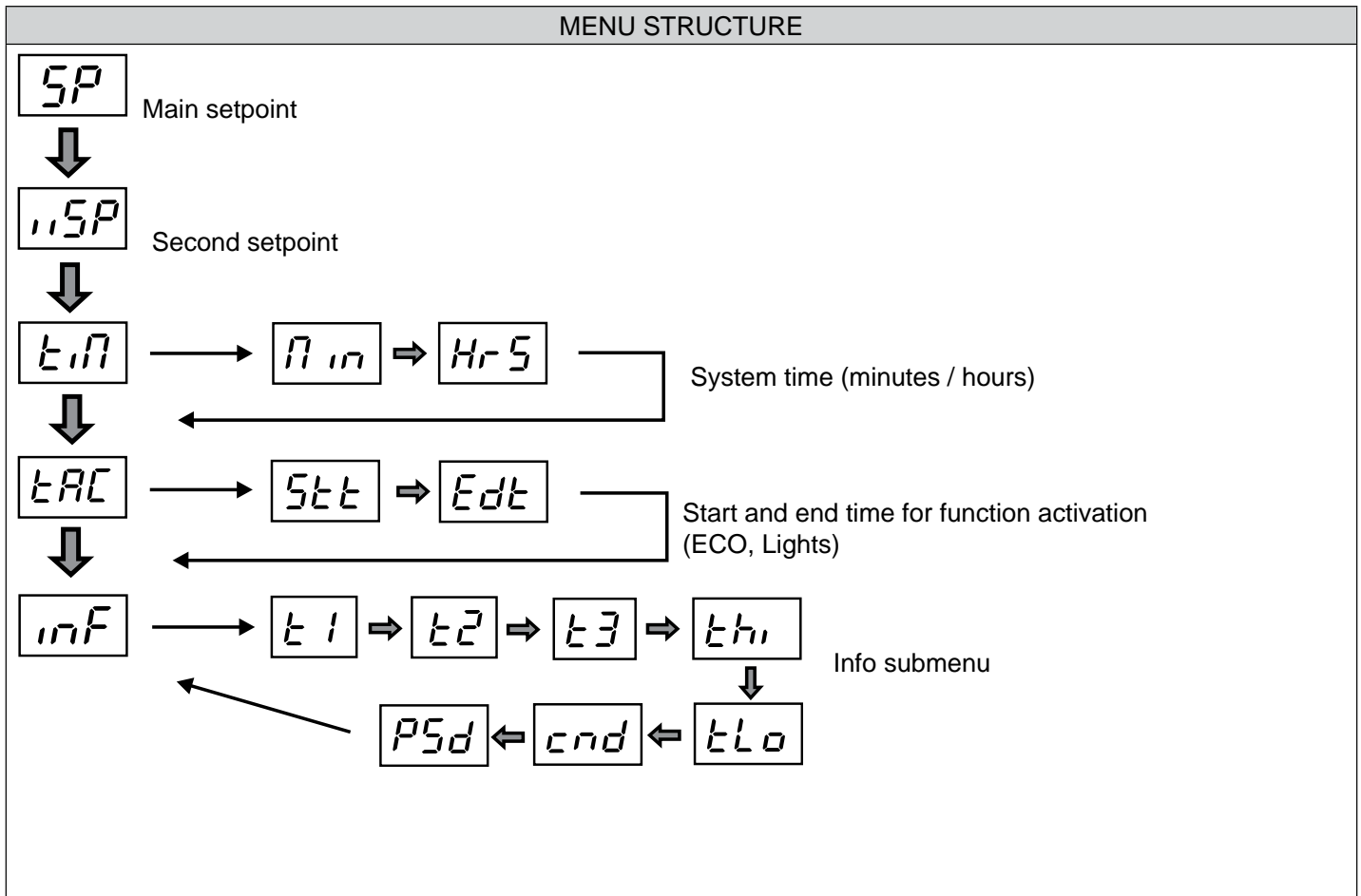

Operation

Time and Temperature Guidelines

To assure quality and safety in chilled processed food handling, it is important to observe the following guidelines.

1. Prechill refrigerated cart for 30 minutes before adding food.
2. All foods must be covered prior to chill or freeze processing.
3. Food temperature will reduce from 140°F to 40°F (60°C to 4°C) within 4 hours.
4. Do not remove food from chiller until it reaches a temperature of 40°F (4°C) or lower.
5. Chilled foods must be stored under refrigeration designed to hold products at 34° to 38°F (1° to 3°C) for a maximum of 5 days. A 5-day shelf life includes the day of production and the day of consumption.
6. Cooked food that has been chilled must be reheated to a minimum core temperature of 165°F (74°C) before serving. Refer to local food codes for possible exceptions.
7. Always reference and adhere to local food codes and HACCP guidelines with regard to time and temperature for chilling or frozen food processing.



CAUTION

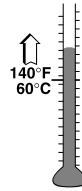

To maintain sanitation control, all foods for quick-chill or quick-freeze processing must be at a temperature above 140°F (60°C) and must be tightly covered.

NOTE

Adequate spacing must be allowed between pans for proper air circulation for both processing and subsequent holding. Stacked pans will restrict air flow and increase chill processing time.

Product Covering

To maintain sanitation control when loading the refrigerated cart, foods must be above 140°F (60°C) and should be tightly covered. A tight cover is an important part of proper chilling methods and must be used to prevent the possibility of accidental contamination by airborne bacteria.

Stainless steel pan covers may be used. Stainless steel covered pans must include a label indicating pan contents and use-by date. A cover of clear plastic wrap is also acceptable.

When using plastic wrap as a food covering, make certain the wrap comes in direct contact with the surface of the product and extends around and down each side of the pan. This is an important step to ensure proper chilling times. Spacing left between the plastic wrap and the surface of the food creates an insulating air gap resulting in more product heat retention and a slower chilling rate.

Meat roasts and other larger, dense products should be no larger than a weight of 8 to 10 pounds (4 to 5 kg) per item. Because of the density of these products, chilling could take up to 4 hours. Due to longer chilling time required, it is also suggested these items be chilled at the end of the day with the chiller set in the automatic chill/hold mode. This method provides the operator with fully chilled product holding at a refrigerated temperature on the following day.

Prior to chilling, roasts must be wrapped in clear plastic and placed in the chiller. Do not slice roasted meats until the day of service.

Portioned meat products such as pork chops or meat patties should be chilled directly on the sheet pans on which they were cooked. Cover the sheet pans with clear plastic wrap for chilling. After chilling, this type of product can be placed in steam table pans for refrigerated storage.

Portioning and Packaging

1. During portioning and packaging operations, all foods should be maintained at or above 140°F (60°C), or below 40°F (4°C).
2. If cooked foods exceed the processing capacity of the refrigerated cart, place hot product in an appropriate back-up hot holding device. Hold hot foods at a temperature above 140°F (60°C).

If a hot food holding cabinet is not available, place hot foods in short-term refrigerated storage until these products can be loaded into the refrigerated cart for the next available processing cycle. Production of cooked foods should not exceed the processing capabilities of the chiller, therefore, do not adopt short-term refrigeration as a routine practice but use only in an emergency situation.
3. Fill containers to a 12 pound (5 kg) limit or maximum depth of 2" (51 mm) of product. Do not use plastic or Lexan® containers.
4. For faster cooling, place lids and over-wrap materials directly on the surface of foods. As previously indicated, air trapped between the lid and food surface acts as an insulator and will increase chill time.
5. For faster chilling times, place low profile foods such as chicken quarters, fish fillets, or ribs in low depth containers such as 1-1/2" (38mm) deep sheet pans.
6. Large cuts of meat and poultry that weigh a maximum of 8 to 10 pounds (4 to 5 kg) should be individually wrapped with tight fitting film and placed on sheet pans in the chill cabinet.

Operation

The following chart of portion sizes and serving capacity per pan is provided as a general reference only.

Portion Sizes and Pan Capacities		
	Pan size >	325 mm x 530 mm x 65 mm
Food category	Serving size	Servings per pan
Breakfast items:		
Griddle cakes, waffles, french toast (2 to 3 each)	113 gm	48
Eggs	57 to 113 gm	96 to 48
Breakfast meats	57 gm	96
Cooked cereals or grains	113 gm	48
Fruit compote	113 gm	48
Meat, poultry, fish, seafood	113 gm	48
Casseroles and extended dishes	170 to 227 gm	32 to 24
Vegetables	113 gm	48
Starches:		
Potato, rice, pasta, stuffings, beans	113 gm	48
Gravies and au jus	57 gm	96
Sauces	113 gm	48
Protein and starch-based salads	113 to 170 gm	48 to 32
Desserts:		
Pudding, custard, mousse, jello	113 gm	48

Food flavor and aroma are usually so closely related that it is difficult, if not impossible, to separate them. There is also an important, inseparable relationship between cleanliness and food flavor. Cleanliness, operating efficiency, and appearance of equipment contribute considerably to savory, appetizing foods.

Most food imparts its own particular aroma and many foods also absorb existing odors. Unfortunately, during this absorption there is not a distinction between **good** and **bad** odors. The majority of objectionable flavors and odors troubling food service operations are caused by bacteria growth. Sourness, rancidity, mustiness, stale or other undesirable flavors are usually the result of germ activity.

The easiest way to ensure full, natural food flavor is through comprehensive cleanliness. This means good control of both visible soil (dirt) and invisible soil (germs). A thorough approach to sanitation will provide essential cleanliness. It will ensure an attractive appearance of equipment, along with maximum efficiency and utility. More importantly, a good sanitation program provides one of the key elements in the prevention of food-borne illnesses.

A comprehensive sanitation program should focus on the training of staff in basic sanitation procedures. This includes personal hygiene, proper handling of raw foods, cooking to a safe internal product temperature, and the routine monitoring of internal food temperatures from the time the food is received through the time the food is served.

A controlled holding environment for prepared foods is just one of the important factors involved in the prevention of food-borne illnesses. Temperature monitoring and control during receiving, storage, preparation, and the service of foods are of equal importance.

The most accurate method of measuring safe temperatures of both hot and cold foods is by internal product temperature. A thermometer is an effective tool for this purpose, and should be routinely used on all products that require holding at a specific temperature.

Internal Food Product Temperatures		
Hot Foods		
Danger Zone	40°F to 140°F	4°C to 60°C
Critical Zone	70°F to 120°F	21°C to 49°C
Safe Zone	140°F to 165°F	60°C to 74°C
Cold Foods		
Danger Zone	Above 40°F	Above 4°C
Safe Zone	36°F to 40°F	2°C to 4°C
Frozen Foods		
Danger Zone	Above 32°F	Above 0°C
Critical Zone	0°F to 32°F	-18°C to 0°C
Safe Zone	0°F or Below	-18°C or Below

Hazard Analysis (at) Critical Control Points (HACCP), is a quality control program of operating procedures to assure food integrity, quality, and safety. Taking steps necessary to augment food safety practices is both cost effective and relatively simple. Additional HACCP information is available by contacting:

Center for Food Safety and Applied Nutrition
 Food and Drug Administration
 Phone: 1-888-SAFEFOOD
www.foodsafety.gov

Cleaning and Preventative Maintenance

Protecting Stainless Steel Surfaces



It is important to guard against corrosion in the care of stainless steel surfaces. Harsh, corrosive, or inappropriate chemicals can completely destroy the protective surface layer of stainless steel. Abrasive pads, steel wool, or metal implements will abrade surfaces causing damage to this protective coating and will eventually result in areas of corrosion. Even water, particularly hard water that contains high to moderate concentrations of chloride, will cause oxidation and pitting that result in rust and corrosion. In addition, many acidic foods spilled and left to remain on metal surfaces are contributing factors that will corrode surfaces.

Proper cleaning agents, materials, and methods are vital to maintaining the appearance and life of this appliance. Spilled foods should be removed and the area wiped as soon as possible but at the very least, a minimum of once per day. Always thoroughly rinse surfaces after using a cleaning agent and wipe standing water as quickly as possible after rinsing.

Cleaning Agents

Use non-abrasive cleaning products designed for use on stainless steel surfaces. Cleaning agents must be chloride-free compounds and must not contain quaternary salts. Never use hydrochloric acid (muriatic acid) on stainless steel surfaces. Failure to observe this precaution will void the warranty. Always use the proper cleaning agent at the manufacturer's recommended strength. Contact your local cleaning supplier for product recommendations.

Cleaning Materials

Cleaning can usually be accomplished with the proper cleaning agent and a soft, clean cloth. When more aggressive methods are needed, use a non-abrasive scouring pad on difficult areas and make certain to scrub with the visible grain of surface metal to avoid surface scratches. Never use wire brushes, metal scouring pads, or scrapers to remove food residue. Failure to observe this precaution will void the warranty.

NOTICE



To protect stainless steel surfaces, completely avoid the use of abrasive cleaning compounds, chloride based cleaners, or cleaners containing quaternary salts. **Never** use hydrochloric acid (muriatic acid) on stainless steel. **Never** use wire brushes, metal scouring pads or scrapers.

! WARNING



To prevent **serious personal injury, death, or property damage:**

The appliance must be cleaned thoroughly to avoid deposits of grease and or food residue inside the appliance that may catch fire. If fat deposits and/or food waste inside the appliance ignite, shut down the appliance immediately and keep the appliance door closed to extinguish the fire. If further extinguishing is required, disconnect the appliance from the main power and use a fire extinguisher (do not use water to extinguish a grease fire!). Failure to clean the appliance properly invalidates the warranty and relieves Alto-Shaam of all liability.

⚠️ WARNING

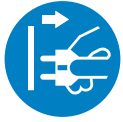

To prevent serious injury, death, or property damage, **always** disconnect the appliance from the power source before cleaning or servicing.

How to Clean the Interior

1. Disconnect appliance from power source.
2. Wipe the interior cavity with a clean cloth to remove loose food debris.
3. Clean the interior with a damp clean cloth or sponge and any good commercial detergent.
Wipe the interior door panel and clean the vinyl gaskets. Make certain to clean under the gaskets to remove any mildew accumulation or food residue.
4. Rinse all interior surfaces by wiping with a sponge and clean warm water.
5. Remove excess water with a sponge and wipe dry with a clean cloth.
6. Wipe interior surfaces with a clean cloth and sanitizing solution for use on metal and vinyl food contact surfaces. This is an important step to control the build-up of unwanted mildew and mold in the refrigeration system.
7. Allow interior to air dry with door open.

How to Clean the Exterior



1. Wipe all exterior surfaces including the control panel, door frame, latches, and hinges with a damp cloth containing a mild, non-abrasive, non-chloride detergent solution.
2. Rinse detergent solution with a cloth and warm water. Allow exterior to air dry.
3. Polish with any standard stainless steel polish designed for use on food service equipment.
When cleaning the exterior of the cabinet, always wipe with the grain of the stainless steel to avoid scratching or marring the finish.

NOTE: Do not use abrasive cleaning compounds or implements.

⚠️ WARNING



To prevent serious personal injury, death, or property damage:

Do not steam clean, hose down or flood the interior or exterior with water or liquid solution of any kind. **Do not** use water jet to clean. Failure to observe this precaution will void the warranty.

How to Clean the Condenser

All the heat removed from the cabinet is discharged into the room via the condenser which is similar to a car radiator. This must be kept clean so that the air can pass through it to remove the heat, if it becomes choked with dust the unit will over heat and this can lead to a burnt out compressor. The condenser should be brushed with a soft brush to remove any dust deposited on the alloy fins. The frequency of this cleaning is determined by the amount of dust in the surrounding area but should be cleaned at least 4 times a year.

How to Replace the Door Gasket

Damaged gaskets can easily be replaced. Remove the old gasket by gently pulling it out of the gasket retainer and simply push in the new gasket leaving the corners to last.





Troubleshooting

Before looking any further, please check the power supply to the unit and controller temperature setting.

Alarms

The controller is equipped with internal visual and audio alarms:

Press any button on the controller to silence an alarm. Verify that the  indicator is lit. If lit, verify that the door is closed and the gasket is sealing correctly. Also, check that the condenser is not choked and that the condenser and evaporator fans are running. If the evaporator is iced up, press and hold the  button to start a manual defrost cycle. If this doesn't solve the problem, please call a qualified technician.

Alarm Displayed	Description	Action Required
<i>do</i>	Door open alarm	Close door
<i>hc</i>	Condenser high temperature alarm	Check for blockage / clean
<i>ALR</i>	High temperature safety stat	Repair / replace relay
<i>hi</i>	High temperature alarm	Press a button to cancel / check
<i>Lo</i>	Low temperature alarm	Press a button to cancel / check
<i>E1</i>	Probe T1 failure	Replace probe
<i>E2</i>	Probe T2 failure	Replace probe
<i>E3</i>	Probe T3 failure	Replace probe

1000-MR2-1

Front View with Cover Removed



Interior View with Fan Guard Removed



Front View with Cover Removed

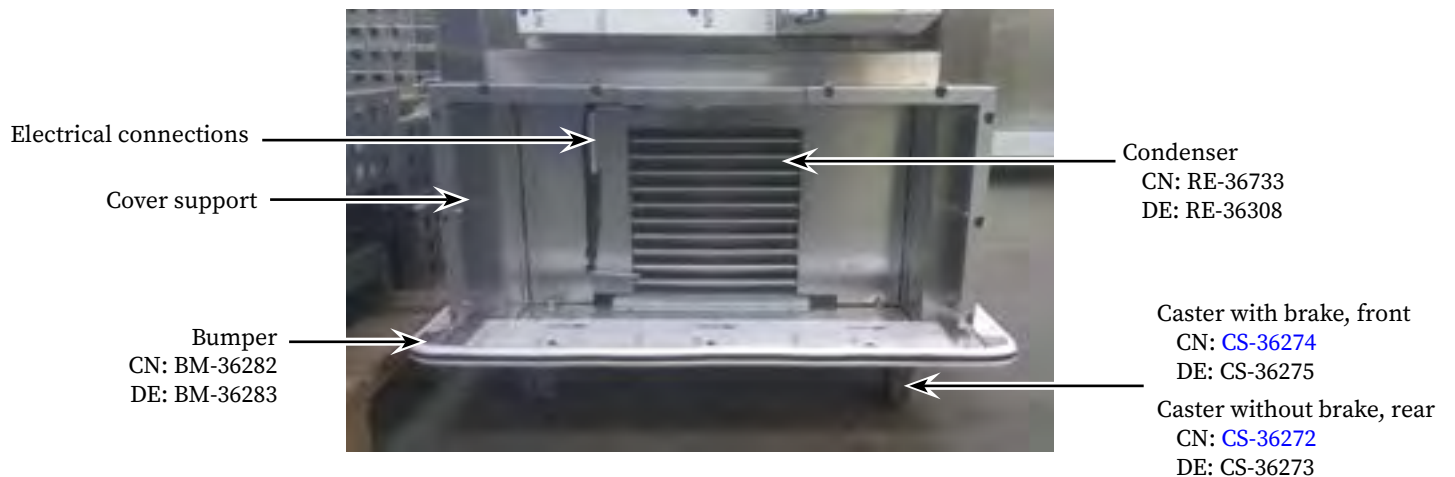

1000-MR2-1 Back View with Panel Removed



1000-MR2-2 - Spare parts

Part number	Description	Picture for reference
RE-37622	Compressor SC15G	
WH-36287	Fan Blade 10 inch 22 Deg Aluminium	
GD-36304	Fan Guard (Grid Metal Chrome) 10" (240mm)	
CN: MO-36288 DE: MO-36289	Motor Condenser Fan 10 Watt EBM PAPST	
CC-37616	Control Panel Assembly with BD1-28 Controller	
CN: BA-37610 DE: BA-37611	Controller Display Unit TU5S-B for LAE-BD1-28	
CC-37617	Controller LAE-BD1 Flat connecting cable 2.0m	
CN: PR-36260 DE: PR-36261	Probe, Air LAE -2 Wire NTC 10K SN4B20P1 2m Long	
CN: RE-36293 DE: RE-36292	Drier Trowser 1/4" Spun Copper	
EL-37618	Rod Heater Defrost 650 Deep Counters 500 Watt	
SW-37619	Door Switch, electric with round magnet	
CN: GS-36262 DE: GS-36263	Gasket PU1013 x 649mm	

Continued on next page

Service

1000-MR2-2 - Spare parts, continued

Part number	Description	Picture for reference
CN: PI-36264 DE: PI-36265	Hinge Pin 601/1401 Cabinets 7.3 mm Shank 10mm Shoulder	
CN: CB-36270 DE: CB-36271	Helicoil Cable/Curly 2-3 Mtr	
FT-36681	Schraeder Valve Access fitting 1/4 x 50mm Tail	
CB-37620	Heater Cable 5.8 Mtr 76 Watt tails 500mm	
BM-36282	Fender Rubber Black	
CN: CS-36272 DE: CS-36273	Caster 156mm High (125mm Wheel) Unbraked- Mobile Units	
CN: CS-36274 DE: CS-36275	Caster 156mm High (125mm Wheel) Braked- Mobile Units	
CN: HG-36266 DE: HG-36267	Hinge Spring Loaded Cabinet Red + Square Pin Holder	
FA-37621	Fan AC220-240V.6.20W 120x120x38mm	
RA-36277	Nylon coated wire Shelf 2/1 GN	
SH-36816	Stainless Steel Wire Shelf 2/1 GN	
CL-36934	Slides 2/1 601 Cabinet Series 579mm	

Continued on next page

1000-MR2-2 - Spare parts, continued

Part number	Description	Picture for reference
PTT26203	Condenser Cabinets 3x11x264 7.2mm	
06.009.01.003	Evaporator 3x5x500 3/8" Tubing	
PTT26216	Coil Vap Serpentine Copper 5/16" for Cabinets/Counters	
PTT26217	Vaporisor Tray Plastic 1.9L 258x136x60.5mm	

Service

1000-MR2-1

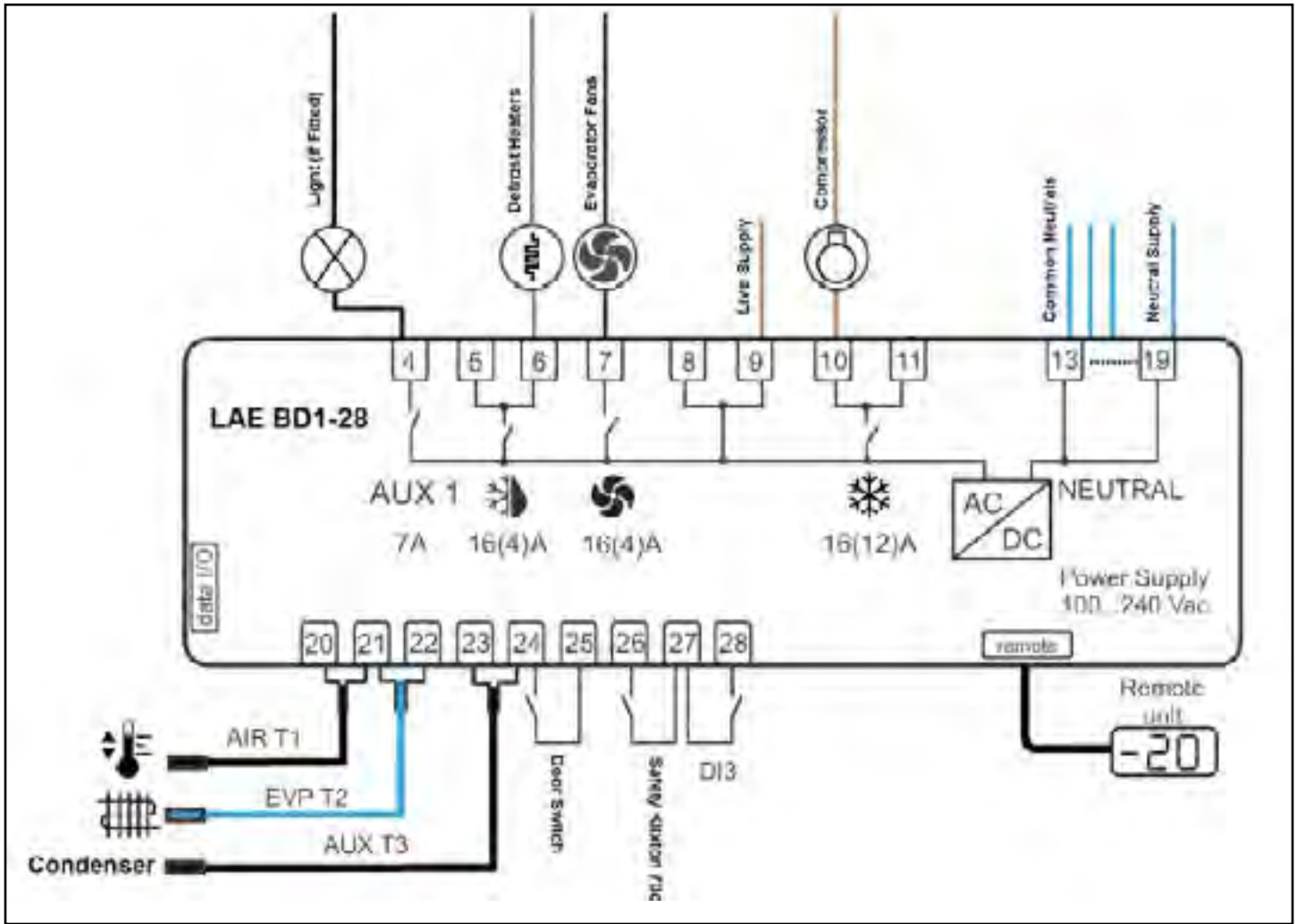

1000-MR2-2

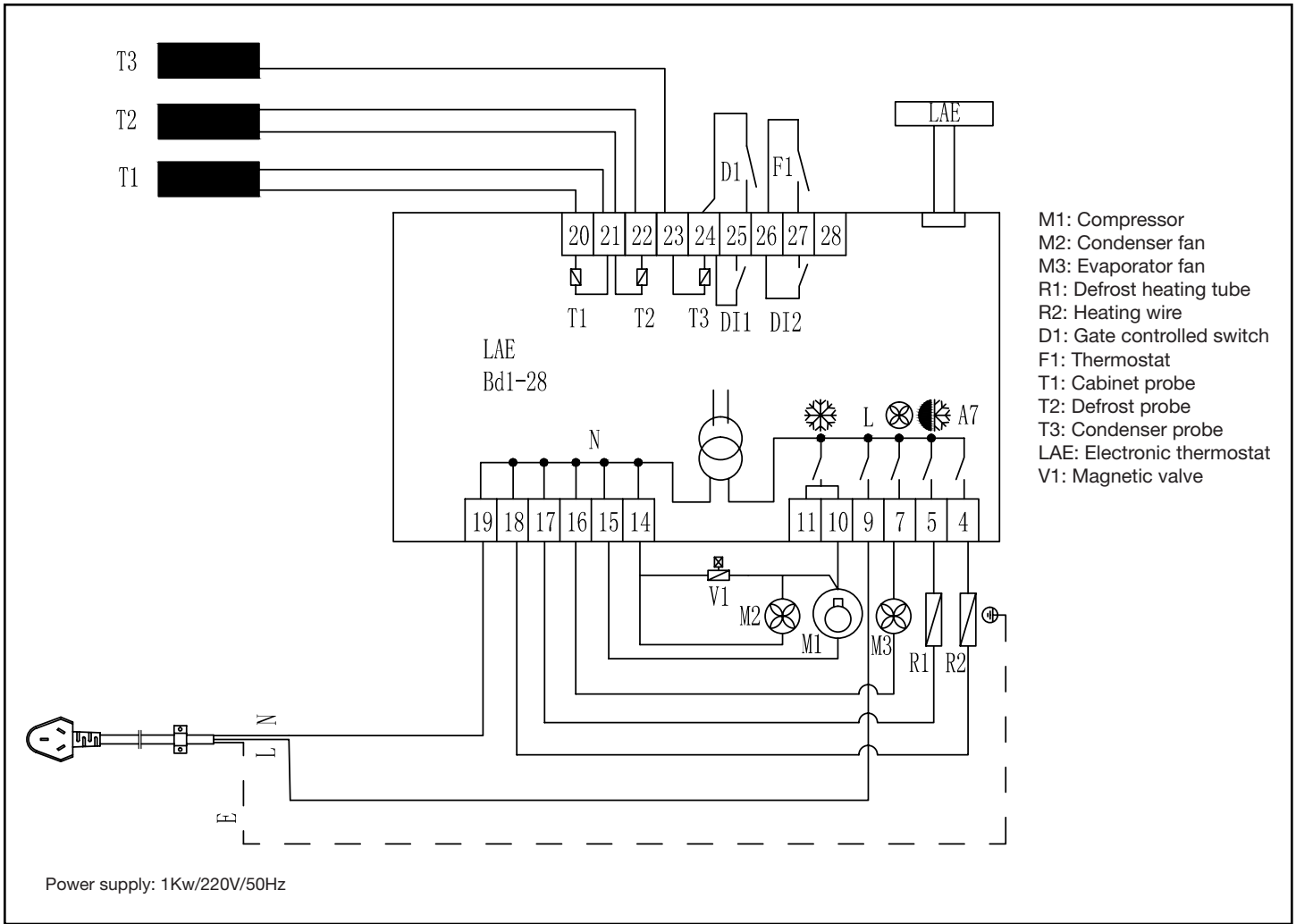

Limited Warranty

Alto-Shaam, Inc. warrants to the original purchaser only that any original part that is found to be defective in material or workmanship will, at Alto-Shaam's option, subject to provisions hereinafter stated, be replaced with a new or rebuilt part.

The original parts warranty period is as follows:

For the refrigeration compressor on Alto-Shaam Quickchillers™, five (5) years from the date of installation of appliance.

For the heating element on Halo Heat® cooking and holding ovens, as long as the original purchaser owns the oven. This excludes holding only equipment.

For all other original parts, one (1) year from the date of installation of appliance or fifteen (15) months from the shipping date, whichever occurs first.

The labor warranty period is one (1) year from the date of installation or fifteen (15) months from the shipping date, whichever occurs first.

Alto-Shaam will bear normal labor charges performed during standard business hours, excluding overtime, holiday rates or any additional fees.

To be valid, a warranty claim must be asserted during the applicable warranty period. This warranty is not transferable.

This warranty does not apply to:

1. Calibration.
2. Replacement of light bulbs, door gaskets, and/or the replacement of glass due to damage of any kind.
3. Equipment damage caused by accident, shipping, improper installation or alteration.
4. Equipment used under conditions of abuse, misuse, carelessness or abnormal conditions, including but not limited to, equipment subjected to harsh or inappropriate chemicals, including but not limited to, compounds containing chloride or quaternary salts, poor water quality, or equipment with missing or altered serial numbers.
5. Damage incurred as a direct result of poor water quality, inadequate maintenance of steam generators and/or surfaces affected by water quality. Water quality and required maintenance of steam generating equipment is the responsibility of the owner/operator.
6. Damage caused by use of any cleaning agent other than Alto-Shaam's Combitherm® Cleaner, including but not limited to damage due to chlorine or other harmful chemicals. **Use of Alto-Shaam's Combitherm® Cleaner on Combitherm® ovens is highly recommended.**
7. Any losses or damage resulting from malfunction, including loss of product, food product, revenue, or consequential or incidental damages of any kind.
8. Equipment modified in any manner from original model, substitution of parts other than factory authorized parts, removal of any parts including legs, or addition of any parts.

This warranty is exclusive and is in lieu of all other warranties, express or implied, including the implied warranties of merchantability and fitness for a particular purpose. In no event shall Alto-Shaam be liable for loss of use, loss of revenue or profit, or loss of product, or for any indirect, special, incidental, or consequential damages. No person except an officer of Alto-Shaam, Inc. is authorized to modify this warranty or to incur on behalf of Alto-Shaam any other obligation or liability in connection with Alto-Shaam equipment.

Effective November 1, 2012

W164 N9221 Water Street • P.O. Box 450
Menomonee Falls, Wisconsin 53052-0450 U.S.A.

PHONE: 262.251.3800 • 800.558.8744 U.S.A. / CANADA
FAX: 262.251.7067 • 800.329.8744 U.S.A. ONLY
www.alto-shaam.com