



# Hot Food Holding Cabinet Deluxe or Simple Control



**300-S**  
**500-S**  
**750-S**  
**1000-S**  
**1200-S**  
**1000-UP**  
**1200-UP**

- **Installation**
- **Operation**
- **Maintenance**

W164 N9221 Water Street • P.O. Box 450  
Menomonee Falls, Wisconsin 53052-0450 U.S.A.

PHONE: 262.251.3800 • 800.558.8744 U.S.A. / CANADA  
FAX: 262.251.7067 • 800.329.8744 U.S.A. ONLY  
[www.alto-shaam.com](http://www.alto-shaam.com)



Consult instructions for operation and use.

---

# Manufacturer's Information

## Copyright

© Copyright 10/23 by Alto-Shaam, Inc.

All rights reserved.

This manual or any portion thereof may not be reproduced or used in any manner whatsoever without the express written permission of Alto-Shaam, Inc.

## Trademarks

All trademarks referenced in this documentation are the property of their respective owners.

## Manufacturer

Alto-Shaam, Inc.

P.O. Box 450

W164 N9221 Water Street

Menomonee Falls, WI 53052

## Original Instructions

The content in this manual is written in American English.

## Service Parts

Interactive parts diagrams for this appliance are available online using our Parts Finder Tool:

**<https://www.alto-shaam.com/en/customer-support/parts>**.

Or, scan the QR code below.



Warranty and Service Information..... 4  
Delivery ..... 5  
Unpacking ..... 6  
Safety Procedures ..... 7  
Labels ..... 9  
Installation ..... 10  
Electrical Connection ..... 20  
Operation ..... 21  
Cleaning and Preventative Maintenance ..... 24  
Troubleshooting..... 26  
Schematics ..... 28  
Limited Warranty..... 30

# Warranty and Service Information

---

## Enjoy your Alto-Shaam Hot Food Holding Cabinet!

---

**Halo Heat® Technology** Time stands still. Only Alto-Shaam Heated Holding Cabinets use Halo Heat® technology. No fans or harsh heating elements. There's more to hot food holding than just keeping food hot. Support food production and extend preparation times outside of peak hours while maintaining the highest quality of food.

## Register your Appliance

---

**Register** Registering your appliance ensures prompt service in the event of a warranty claim. You will also receive direct notifications of software updates and additional product information.

Your personal information will not be shared with any other company.

[www.alto-shaam.com/warranty](http://www.alto-shaam.com/warranty)

## Alto-Shaam 24/7 Emergency Repair Service

---

**Call** Call 800-558-8744 to reach our 24-hour emergency service call center for immediate access to local authorized service agencies outside standard business hours. The emergency service access is provided exclusively for Alto-Shaam equipment and is available throughout the United States through Alto-Shaam's toll free number.

**Availability** Emergency service access is available seven days a week, including holidays.

This Alto-Shaam appliance has been thoroughly tested and inspected to ensure only the highest quality appliance is provided. Upon receipt, check for any possible shipping damage and report it at once to the delivering carrier.

This appliance, including unattached items and accessories, may be delivered in one or more packages. Ensure all standard items and options have been received with each appliance as ordered. Save all the information packed with the appliance. Register the appliance online at [www.alto-shaam.com/en/customer-support/warranty-registration](http://www.alto-shaam.com/en/customer-support/warranty-registration) to ensure prompt service in the event of a warranty parts and labor claim.

This manual must be read and understood by all people using or installing the appliance. Contact the Alto-Shaam Tech Team Service Department if you have any questions concerning installation, operation, or maintenance.

1-800-558-8744; servicedept@alto-shaam.com

**The serial number is required for all inquiries.**

Always include both model and serial number(s) in any correspondence regarding the appliance.

**Model:** \_\_\_\_\_

**Serial number:** \_\_\_\_\_

**Purchased from:** \_\_\_\_\_

**Date installed:** \_\_\_\_\_ **Voltage:** \_\_\_\_\_

### Environmental Conditions

#### Operational Environmental Conditions

- Before use, appliance must acclimate to room temperature in the environment it is placed — 24 hours is recommended.
- Ambient temperature range of 60°F to 110°F (16°C to 43°C).
- Relative humidity of less than 95% non-condensation.
- Atmospheric pressure range of 50kPa to 106kPa.

- Carefully remove the appliance from the carton or crate.

**NOTE:** Do not discard the carton and other packaging material until you have inspected the appliance for hidden damage and tested it for proper operation.

Do not discard this manual. This manual is considered to be part of the appliance and is to be provided to the owner or manager of the business or to the person responsible for training operators. Additional manuals are available from the manufacturer.

- Read all instructions in this manual carefully before installing this appliance, using the appliance or performing routine maintenance. Following procedures other than those indicated in this guide to use and clean the appliance is considered inappropriate and may cause damage, injury or fatal accidents, in addition to voiding the warranty and relieving Alto-Shaam of all liability.
- Remove all protective plastic film, packaging materials, and accessories from the appliance before connecting electrical power. Store any accessories in a convenient place for future use.

- The appliance is intended to hold hot food for the purpose of human consumption. No other use for this appliance is authorized and is therefore considered dangerous. The appliance must not be used to hold food containing flammable materials (such as food with alcohol). Substances with a low flash point can ignite spontaneously and cause a fire.
- The appliance is intended for use in commercial establishments where all operators are familiar with the purpose, limitations, and associated hazards of this appliance. Operating instructions and warnings must be read and understood by all operators and users.
- This appliance is intended to be used for commercial applications, for example in kitchens of restaurants, canteens, hospitals and in commercial enterprises such as bakeries, butcheries, etc., but not for continuous mass production of food.
- This appliance is not intended to be used by laymen in household and similar applications such as: staff kitchen areas in shops, offices, and other working environments; farmhouses, hotels, motels and other residential type environments; bed and breakfast type environments.
- Any troubleshooting guides, component views, and parts lists included in this manual are for general reference only and are intended for use by qualified and trained technicians.
- This manual should be considered a permanent part of this appliance. This manual and all supplied instructions, diagrams, schematics, parts lists, notices, and labels must remain with the appliance if the appliance is sold or moved to another location.

The following signal words and symbols may be used throughout this manual.

**⚠ DANGER**  
Indicates a hazardous situation that, if not avoided, will result in death or serious injury.

**⚠ WARNING**  
Indicates a hazardous situation that, if not avoided, could result in death or serious injury.

**⚠ CAUTION**  
Indicates a hazardous situation that, if not avoided, could result in minor or moderate injury.



**NOTICE:** Indicates information considered important, but not hazard-related (e.g., messages relating to property damage).

**NOTICE:** For equipment delivered for use in any location regulated by the following directive: 2012/19/EC WEEE



**Do not** dispose of electrical or electronic equipment with other municipal waste.

- To prevent serious injury, death or property damage, the appliance should be inspected and serviced at least every twelve (12) months by an authorized service partner or trained technician.
- **Only** allow an authorized service partner or trained technician to service or to repair the appliance. Installation or repairs that are not performed by an authorized service partner or trained technician, or the use of non-factory authorized parts will void the warranty and relieve Alto-Shaam of all liability.
- When working on this appliance, observe precautions in the literature, on tags, on labels attached to or shipped with the appliance and other safety precautions that may apply.
- If the appliance is installed on casters, freedom of movement of the appliance must be restricted so that utility connections (including gas, water, and electricity) cannot be damaged when the appliance is moved. If the appliance is moved, ensure that all utility connections are properly disconnected. If the appliance is returned to its original position, ensure that retention devices and utility connections are properly connected.
- **Only** use the appliance when it is stationary. Mobile appliance racks, mobile plate racks, transport trolleys, and appliances on casters can tip over when being moved over an uneven floor or threshold and cause serious injury.
- **Always** apply caster brakes on mobile appliances or accessories when these are not being moved. These items could move or roll on uneven floors and cause property damage or serious injury.
- Be extremely careful when moving appliances because the food trays may contain hot fluids that may spill, causing serious injury.
- **Always** open the appliance door very slowly. Escaping hot vapors or steam can cause serious injury.

 <b>WARNING</b>	
	<p>To prevent <b>serious personal injury, death, or property damage:</b></p> <p>The appliance must be cleaned thoroughly to avoid deposits of grease and or food residue inside the appliance that may catch fire. If fat deposits and/or food waste inside the appliance ignite, shut down the appliance immediately and keep the appliance door closed to extinguish the fire. If further extinguishing is required, disconnect the appliance from the main power and call the fire department. Failure to clean the appliance properly voids the warranty and relieves Alto-Shaam of all liability.</p>

### Operator qualifications

Only trained personnel with the following operator qualifications are permitted to use the appliance:





- Have received proper instruction on how to use the appliance.
- Have demonstrated their ability with commercial kitchens and commercial appliances.

The appliance must not be used by:

- Persons (including children) with reduced physical, sensory or mental capabilities, or lack of experience and knowledge, unless they have been given supervision concerning use of the appliance by person responsible for their safety.
- People impaired by drugs or alcohol.

Regarding children:

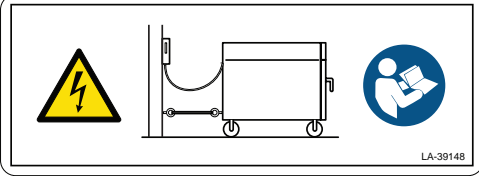
- Children should be supervised to ensure that they do not play with the appliance.
- Children shall neither clean nor maintain the appliance.

	<p>Made in U.S.A.</p>
	<p>Security seal</p>
<p style="text-align: center;"><b>ALTO-SHAAM</b></p> <p>Every Alto-Shaam product is precision calibrated prior to release from the factory to ensure accurate temperature control.</p> <p>CALIBRATION TECHNICIAN _____</p> <p><small>LA-26378</small></p>	<p>Every Alto-Shaam product is precision calibrated prior to release from the factory to ensure accurate temperature control.</p>
	<p>WARNING Hot surface</p>
<div style="border: 1px solid black; padding: 5px;"> <p><b>⚠ WARNING/ADVERTENCIA/AVERTISSEMENT</b></p> <p><b>⚡ Electric Shock Hazard</b> Appliances with permanent electrical connection that are mounted on casters must be secured to building structure. Read installation instructions.</p> <p><b>⚠ Peligro de descarga eléctrica</b> Los equipos con una conexión eléctrica permanente que estén montados sobre ruedas deben estar fijos a la estructura del edificio. Lea las instrucciones de instalación.</p> <p><b>⚠ Risque d'électrocution</b> Les appareils à branchement électrique fixe qui sont montés sur roulettes doivent être attachés à la structure du bâtiment. Lire les instructions d'installation.</p> <p style="text-align: right;"><small>LA-38912</small></p> </div> <div style="border: 1px solid black; padding: 5px; margin-top: 10px;">  <p style="text-align: right;"><small>LA-39148</small></p> </div>	<p>WARNING Electric Shock Hazard</p> <p>Appliances with permanent electrical connection that are mounted on casters must be secured to building structure. Read installation instructions.</p>
	<p>WARNING Electric shock</p>

## WARNING

Improper installation, alteration, adjustment, service, cleaning, or maintenance could result in property damage, severe injury, or death.

Read and understand the installation, operating and maintenance instructions thoroughly before installing, servicing, or operating this equipment.

## WARNING



To prevent personal injury, death or property damage:

**Do not** store or use gasoline or other flammable vapors or liquids in the vicinity of this or any other appliance.

## CAUTION



Appliance and accessories may be heavy. To prevent serious injury, **always** use a sufficient number of trained and experienced workers when moving or leveling appliance and handling accessories.

The Alto-Shaam Hot Food Holding Cabinet must be installed in a location that will permit the oven to function for its intended purpose and to allow adequate clearance for ventilation, proper cleaning, and maintenance access.

1. The appliance must be installed on a stable and level surface free of vibration and suitably strong enough to support the combined weights of the appliance plus the maximum product load weight.
2. **Do not** install this appliance in any area where it may be affected by any adverse conditions such as steam, grease, dripping water, high temperatures, or any other adverse conditions.
3. This appliance must be kept free and clear of any combustible materials.
4. This appliance must be kept free and clear of any obstructions blocking access for maintenance or service.

Emissions testing conducted by Underwriters Laboratories, Inc.® was found to be in compliance with the applicable requirements of NFPA96: 2004 Edition, Par. 4.1.1.2. U.L emissions sampling of grease laden vapor resulted in a total of 0.55 milligrams per cubic meter with no visible smoke and is considered representative of all oven models in the line. Based on these results, hood installation and/or outside venting should not be a requirement in most areas. Verify local codes for locations where more restrictive codes are applicable.

Minimum Clearance Requirements	
Rear	3" (76mm)
Top	2" (51mm)
Left side , Right side	1" (25mm)

## NOTICE

If the appliance has been unplugged for an extended period of time, the Real Time Clock may require recharging. Turn main breaker to the unit off for 10 seconds and then restore power. For more information, see Error Code E-60 in the Troubleshooting section of this manual.

**Model 300-S**

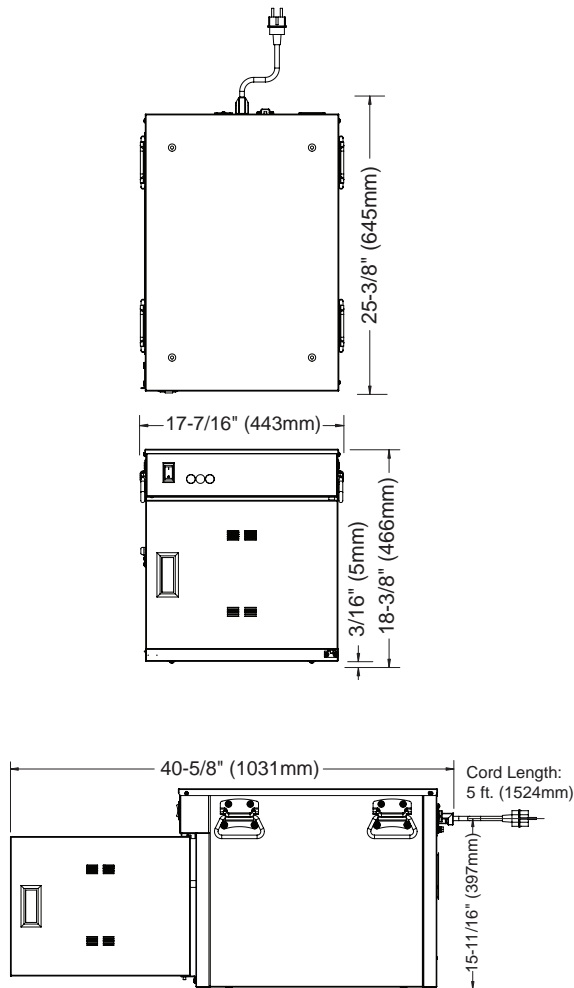

**Model 500-S**

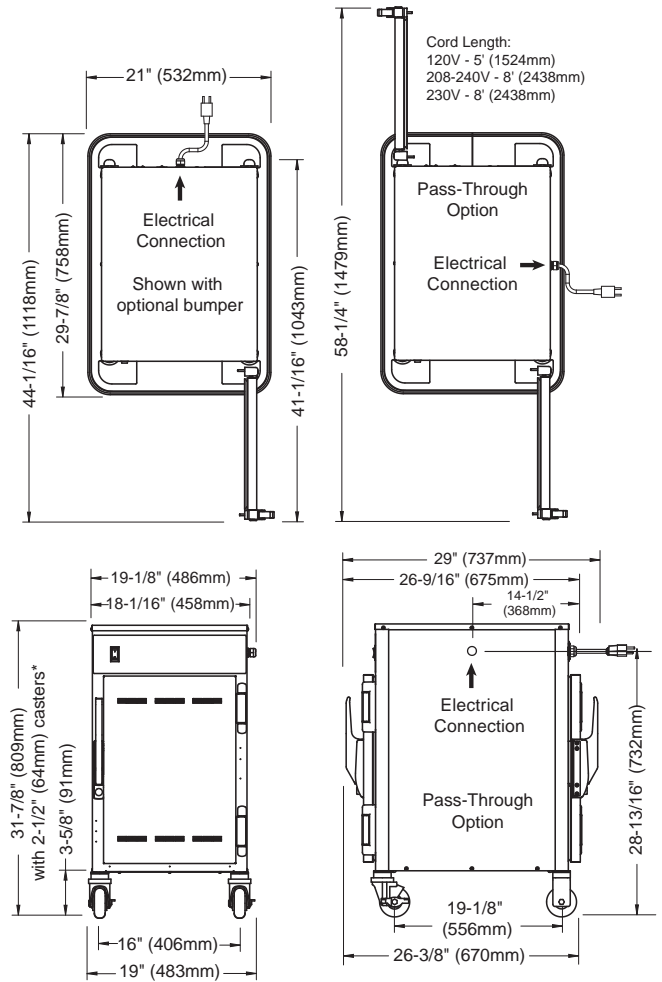

\*33-3/8" (848mm) - with optional 3-1/2" (89mm) casters  
 \*35-1/4" (894mm) - with optional 5" (127mm) casters  
 \*33-3/4" (857mm) - with optional 6" (152mm) legs

<b>300-S</b>	
<b>Weight</b>	
<b>Net</b>	65 lb (29 kg)
<b>Ship</b>	125 lb (57 kg)
<b>Capacity</b>	
36 lbs (16 kg) maximum Volume maximum: 22.5 quarts (28,5 liters)	
<b>Full-size pans:</b>	<b>Gastronorm 1/1:</b>
Three (3)	20" x 12" x 2-1/2" 530mm x 325mm x 65mm
Two (2)	20" x 12" x 4" 530mm x 325mm x 100mm
On wire shelves only	
<b>Half-size pans:</b>	
Six (6)	10" x 12" x 2-1/2" 265mm x 325mm x 65mm
Four (4)	10" x 12" x 4" 265mm x 325mm x 100mm

<b>500-S</b>	
<b>Weight</b>	
<b>Net</b>	110 lb (50kg) est.
<b>Ship</b>	150 lb (68kg)
<b>Capacity</b>	
60 lbs (27 kg) maximum Volume maximum: 50 quarts (47.5 liters)	
<b>Full-size pans:</b>	<b>Gastronorm 1/1:</b>
Six (6)	20" x 12" x 2-1/2" 530mm x 325mm x 65mm
Three (3)	20" x 12" x 4" 530mm x 325mm x 100mm
<b>Half-size sheet pans:</b>	
Eleven (11)	18" x 13" x 1" 457mm x 330mm x 25mm

## Model 750-S

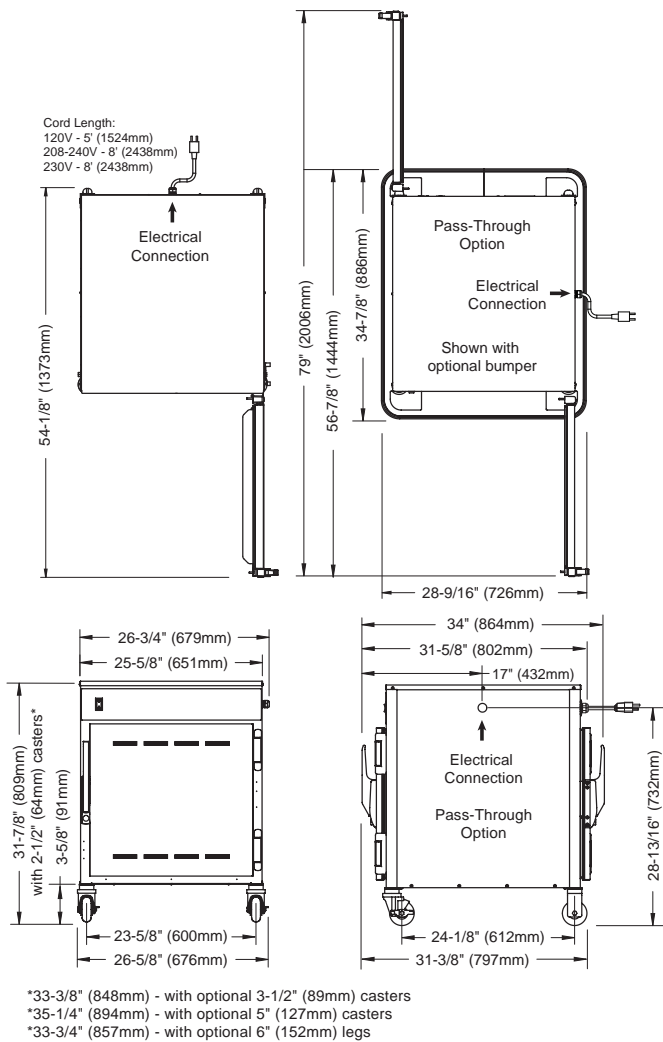

## Model 1000-S

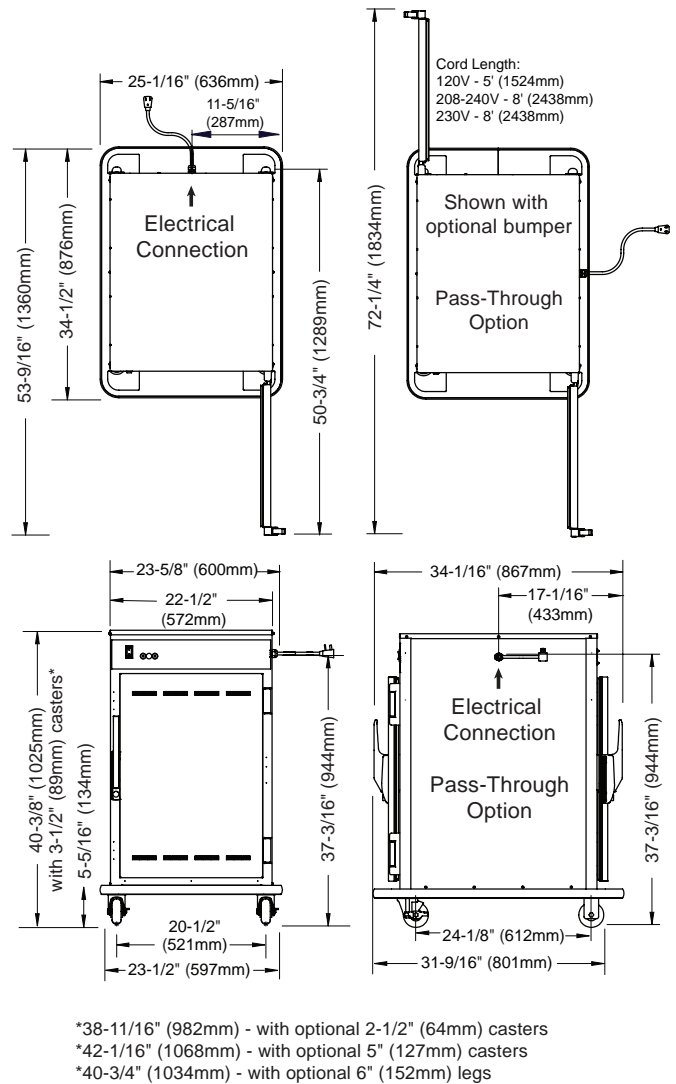

<b>750-S</b>	
<b>Weight</b>	
<b>Net</b>	157 lb (69kg)
<b>Ship</b>	228 lb (103kg) est.
<b>Capacity</b>	
120 lbs (54 kg) maximum Volume maximum: 100 quarts (95 liters)	
<b>Full-size pans:</b>	<b>Gastronorm 1/1:</b>
Ten (10) 20" x 12" x 2-1/2"	530mm x 325mm x 65mm
Six (6) 20" x 12" x 4"	530mm x 325mm x 100mm
Four (4) 20" x 12" x 6"	530mm x 325mm x 150mm
<b>Full-size sheet pans (on wire shelves only):</b>	
Up to Six (6) 18" x 26" x 1" - with additional shelves	

<b>1000-S</b>	
<b>Weight</b>	
<b>Net</b>	175 lb (79kg) est.
<b>Ship</b>	223 lb (101kg) est.
<b>Capacity</b>	
120 lbs (54kg) maximum Volume maximum: 60 quarts (76 liters)	
<b>Full-size pans:</b>	<b>Gastronorm 1/1:</b>
Four (4) 20" x 12" x 2-1/2"	530mm x 325mm x 65mm
On optional wire shelves only	
<b>Full-size sheet pans:</b>	
Eight (8) 18" x 26" x 1"	



## Model 1200-UP

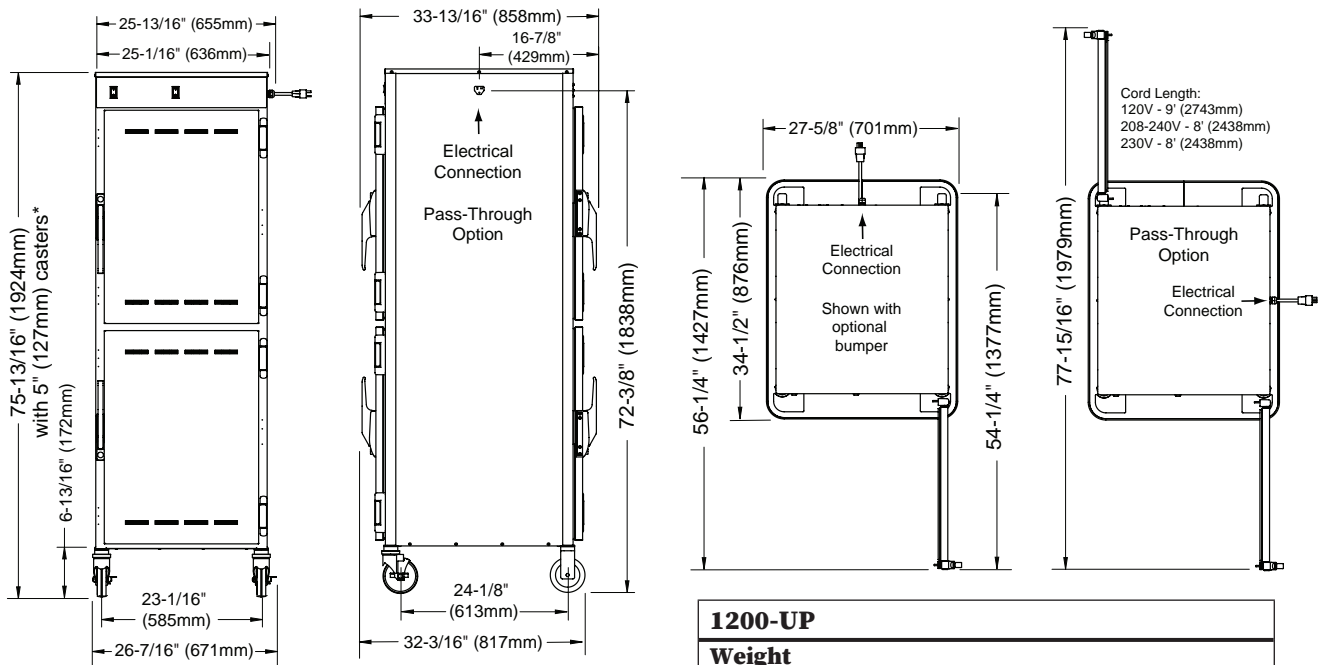

\*74-1/16" (1881mm) - with optional 3-1/2" (89mm) casters  
 \*75-5/8" (1921mm) - with optional 6" (152mm) legs

<b>1200-UP</b>	
<b>Weight</b>	
<b>Net:</b>	333 lb (151 kg)
<b>Ship: (est.)</b>	393 lb (178 kg)

<b>Capacity - 1200-S, 1200-UP (per compartment)</b>		
192 lbs (87kg) maximum • Volume maximum: 120 quarts (152 liters)		
<b>Pan slides (2 per set) - 1-3/4" (44mm) centers</b>		
<b>Pan Size</b>	<b>Four (4) sets of pan slides provided</b>	<b>Maximum capacity with additional pan slides</b>
Full size: 20" x 12" x 2-1/2" GN1/1: 530mm x 325mm x 65mm	Eight (8) pans - 2 per set of slides	Sixteen (16) pans - with 4 additional sets of pan slides
Full size: 20" x 12" x 4" GN1/1: 530mm x 325mm x 100mm	Eight (8) pans - 2 per set of slides	No additional capacity
Full size: 20" x 12" x 6" 530mm x 325mm x 150mm	Eight (8) pans - 2 per set of slides	No additional capacity
Full size sheet pans: 18" x 26" x 1"	Four (4) pans - 1 per set of slides	Sixteen (16) pans - with 12 additional sets of pan slides
<b>Side Racks and Shelves</b>		
<b>Pan Size</b>	<b>Three (3) shelves provided</b>	<b>Maximum capacity with additional shelves</b>
Full size: 20" x 12" x 2-1/2" GN1/1: 530mm x 325mm x 65mm	Sixteen (16) pans - 2 per side rack	No additional capacity
Full size: 20" x 12" x 4" GN1/1: 530mm x 325mm x 100mm	Eight (8) pans - 2 per side rack	No additional capacity
Full size: 20" x 12" x 6" GN1/1: 530mm x 325mm x 150mm	Eight (8) pans - 2 per side rack	No additional capacity
Full size sheet pans: 18" x 26" x 1"	Three (3) pans - 1 per shelf	Eight (8) pans with 5 additional shelves

**Universal Pan Slides**

Shown with universal pan slides.  
Two (2) slides needed per pan.

**Universal Pan Slides**  
SR-24762, stainless steel  
SR-24447, chrome plate

**Side Rail**  
1011741

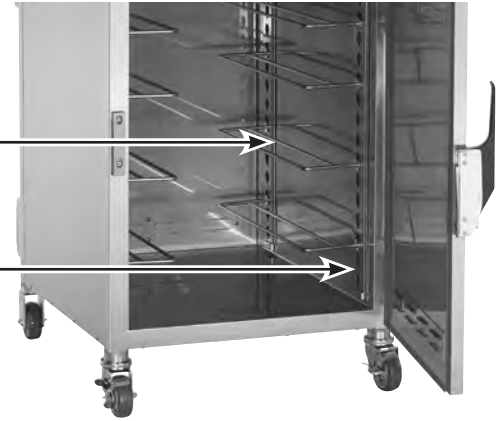
**Side Racks and Shelves (optional)**

As an alternative to universal pan slides, this appliance can be ordered as a “side rack” model which is equipped with two (2) side racks and three (3) chrome plated wire shelves. It will accommodate full and half size US hotel and European gastronorm pans on the side racks or shelves, or sheet pans on shelves.

**Shelf**  
SH-23738, stainless steel  
SH-2733, chrome plate

**Side Rack**  
1011743

**Before Initial Use**

Thoroughly clean the appliance. See the Cleaning and Preventative Maintenance section of this manual for cleaning instructions.

## Stacking Instructions

- 1) If the two appliances were shipped together from the factory, the top appliance will have the casters already removed. A stacking kit will be included with the shipment.

If casters need to be removed, lay the appliance on its back, and using a rubber or non-marring hammer, tap on the top and underside of the caster, alternating sides, until the caster slides out.

- 2) While appliance is laid on its back, insert one stacking post in each of the four corners of the upper appliance. Secure the stacking posts using one screw and two flat washers that are included with the stacking kit. Use template 68696 to locate set screw hole. Drill with #30 Bit and Tap 8-32.

**NOTE:** The flange on the stacking posts must face the outside of the appliance.

- 3) Remove the four top mounting screws from the lower appliance. Place the upper appliance, which has the stacking posts installed, on top of the bottom appliance. Center the top appliance from front to back. Re-install the four screws through the flange of the four stacking posts.

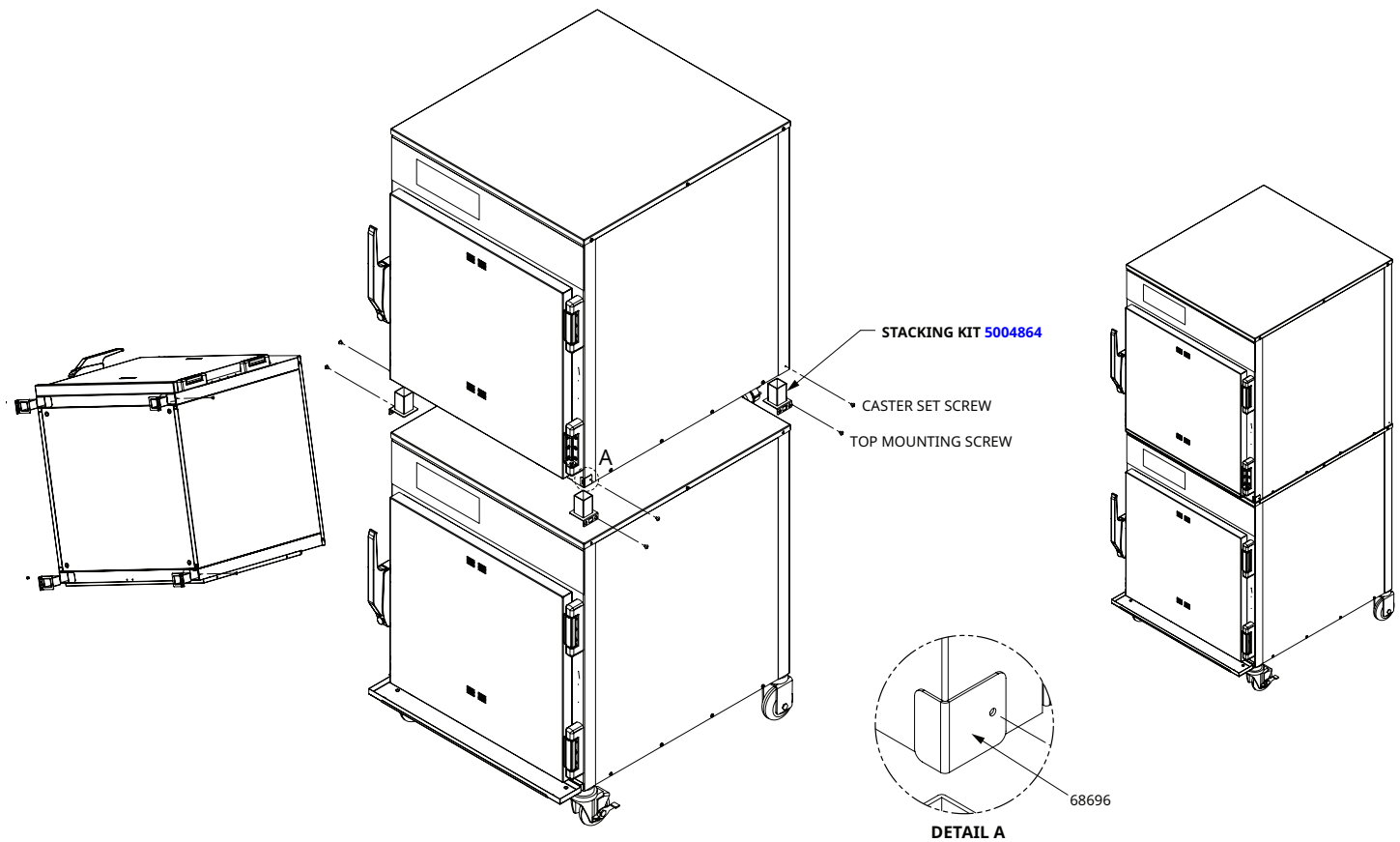

Stacking Configurations	
Model	Can be stacked with:
300-S	300-S or 300-TH/III No stacking hardware needed. Align dimples at top and bottom of appliances. It is recommended that the legs be removed from the top appliance before stacking.
500-S	500-S, 500-TH-II or 500-TH/III
750-S	750-S, 750-TH-II, 750-TH/III, 767-SK, 767-SK/III
1000-S	1000-S, 1000-TH/III, 1000-SK/II, 1000-SK/III
1200-S	1200-S

 <b>WARNING</b>	
	<p><b>ELECTRIC SHOCK HAZARD.</b></p> <p>To prevent <b>SERIOUS INJURY</b> or <b>DEATH</b>, your appliance must be secured to building structure to prevent unintended movement.</p>

 <b>WARNING</b>	
	<p>To prevent personal injury, death or property damage:</p> <p><b>Do not</b> store or use gasoline or other flammable vapors or liquids in the vicinity of this or any other appliance.</p>

A number of adjustments are associated with initial installation and start-up. It is important that these adjustments be conducted by a qualified service technician. Installation and start-up adjustments are the responsibility of the dealer or user. These adjustments include but are not limited to thermostat calibration, door adjustment, leveling, electrical hook-up and installation of optional casters or legs.

1. The appliance must be installed on a stable, non-combustible level horizontal surface. For appliance installed with casters, it is important that the floor surface be level due to the probability of frequent oven repositioning.

Level the appliance from side-to-side and front-to-back with the use of a spirit level.

**NOTE:** Failure to properly level this appliance may result in spills from a semi-liquid product.

2. **DO NOT** install this appliance in any area where it may be affected by any adverse conditions such as steam, grease, dripping water, high temperatures, or any other severely adverse conditions.
3. This appliance must be kept free and clear of any combustible materials.

### **Restraint Requirements for Mobile Equipment**

Any appliance that is not furnished with a power supply cord but includes a set of casters must be installed with a tether. Adequate means must be provided to limit the movement of this appliance without depending on or transmitting stress to the electrical conduit. The following requirements apply:

1. Casters must be a maximum height of 6" (152mm).
2. Two of the casters must be the locking type.
3. Mobile appliances or appliances on mobile stands must be installed with the a flexible connector secured to the building structure.

A mounting connector for a restraining device is located on the upper back flange of the appliance. A flexible connector is not supplied by nor is it available from the factory.

## How to Install the Drip Tray

 **WARNING**



**Personal injury hazard.**  
Install the drip tray to prevent a potential leakage hazard and equipment damage.

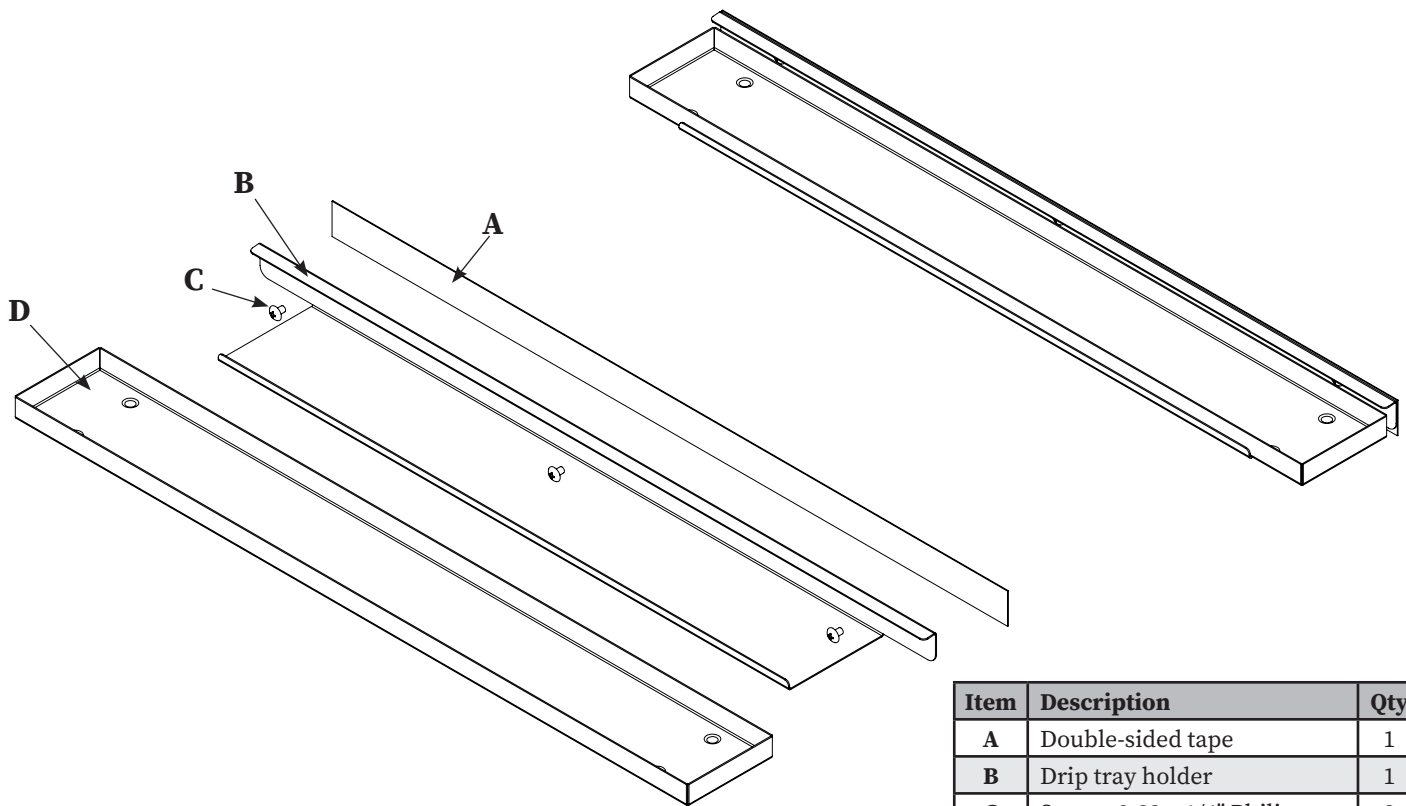

Item	Description	Qty
A	Double-sided tape	1
B	Drip tray holder	1
C	Screw, 8-32 x 1/4" Philips	3
D	Drip tray	1

1. Poke holes through the double-sided tape **A** which is attached to the back of the drip tray holder **B**.
2. Remove the backing on the double-sided tape **A**.
3. Put the screws **C** through the holes and attach the drip tray holder **B** to the front of the appliance.
4. Optional - apply a line of food-grade silicone caulk along the top edge of the drip tray holder **B** to seal.
5. Place the drip tray **D** in the drip tray holder **B**.

## Options and Accessories





Model >	300-S	500-S	750-S	1000-S	1200-S	1000-UP	1200-UP
Description	Part Number						
Bumper, Full Perimeter	---	5011161	5010371	5009767	5012932	5009767	5012932
Carving Holder, Prime Rib	HL-2635	HL-2635	HL-2635	---	---	---	---
Carving Holder, Steamship (Cafeteria) Round	---	4459	4459	---	---	---	---
Caster Package	2-1/2" (64mm)	Standard	Standard	5008022	---	---	---
	3-1/2" (89mm)	5008017	5008017	Standard	5008017	5008017	5008017
	5" (127mm)	5004862	5004862	5004862	Standard	Standard	Standard
Door Assembly, Window	---	---	5013129	5012806	5012822	5012806	5012822
Door Lock with Key	---	LK-22567	LK-22567	LK-22567	LK-22567	LK-22567	LK-22567
Drip Pan	with Drain	---	14813	14831	5005616	5014448	5005616
	without Drain	PN-2122	11898	1014684	11906	---	11906
Drip Tray, Door	---	5010736	5010391	5009716	---	---	---
Deluxe Control (factory installed)	---	Available	Available	Available	Available	Available	Available
Exterior Color Options	Stainless Steel	---	Standard	---	---	---	---
	Burgundy	---	Available	---	---	---	---
	Custom Color	---	Available	---	---	---	---
Handle Kit, Push/Pull (set of four)	STANDARD	55662	55662	55662	55662	55662	55662
Legs, 6" (152mm), Flanged	---	5011149	5011149	5011149	5011149	5011149	5011149
Pan Grid, Wire 18" x 26" (457mm x 660mm)	---	---	PN-2115	PN-2115	PN-2115	PN-2115	PN-2115
Probe, Internal Product Temp. (Deluxe only)	---	PR-36065	PR-36065	PR-36065	PR-36065	PR-36065	PR-36065
Security Panel with Key Lock	---	5013939	5013936	5013934	5013936	5013934	5013936
Shelf	Chrome Wire	SH-2107	SH-2107	SH-2105	---	SH-2733	---
	Chrome Wire, Pass-Through	---	---	SH-2327	---	---	---
	Stainless Steel Wire	---	SH-2326	SH-2324	SH-2325	SH-23738	SH-2325
	Stainless Steel, Rib Rack	---	---	SH-2743	---	---	---
	Stainless Steel, Pass-Through	---	---	---	SH-2346	---	SH-2346
Side Rack Kit (factory installed)	---	---	---	---	Available	---	Available
Stacking Hardware	S-Series over S-Series	---	5004864	5004864	5004864	5004864	---
	CTX4-10 over S-Series	---	---	5019679	5019679	---	---
Universal Angle Pan Slides	Chrome	---	---	---	---	SR-24447	---
	Stainless Steel	---	---	---	---	SR-24762	---
Water Reservoir, Pan	---	---	---	1775	1775	1775	1775
Water Reservoir, Pan Cover	---	---	---	1774	1774	1774	1774



- A rating tag is permanently mounted on the appliance. Make sure the power source matches the voltage identified on the rating tag.
- Plug the appliance into a properly grounded receptacle **only**, positioning the appliance so the power supply cord is easily accessible in case of an emergency.
- Arcing will occur when connecting or disconnecting the appliance unless the controller is OFF.

### Hard wired models

Hard wired models must be equipped with a country certified external allpole disconnection switch with sufficient contact separation. Hard wired models that are mounted on casters must have a strain relief device (tether) to prevent strain on the power supply cord. If a power cord is used for the connection of the product an oil resistant cord like H05RN or H07RN or equivalent must be used.

**NOTICE:** Where local codes and CE regulatory requirements apply, appliances must be connected to an electrical circuit that is protected by an external GFCI outlet.

 <b>WARNING</b>	
	To prevent serious injury, death, or property damage: All electrical connections must be made by a qualified and trained service technician in accordance with applicable electrical codes.
	This appliance must be adequately grounded in accordance with local electrical codes or, in the absence of local codes, with the current edition of the National Electrical Code ANSI/NFPA No. 70. In Canada, all electrical connections are to be made in accordance with CSA C22.1, Canadian Electrical Code Part 1 or local codes.
	CE-approved appliances include an equipotential-bonding terminal marked with the symbol shown on the left. Provisions for earthing are to be made in accordance with IEC:2010 60335-1 section 27 or local codes.

 <b>CAUTION</b>	
	Power source must match voltage identified on appliance rating tag. The rating tag provides essential technical information required for any appliance installation, maintenance or repairs. Do not remove, damage or modify the rating tag.

 <b>WARNING</b>	
Improper installation, alteration, adjustment, service, cleaning, or maintenance could result in property damage, severe injury, or death.	
Read and understand the installation, operating and maintenance instructions thoroughly before installing, servicing, or operating this equipment.	

## Simple Control

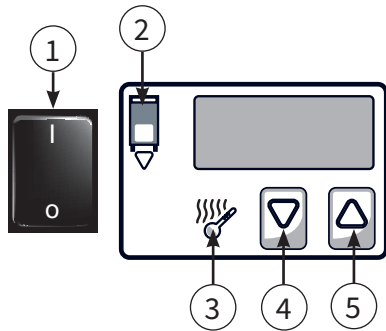

1. Preheat the holding cabinet at 200°F (93°C) for 30 minutes before loading hot food.
  - a) Press the ON/OFF switch ① to the ON (I) position.  
To reduce preheat time, rotate the vents inside the door to close them.
  - b) Press the up arrow button ⑤ or the down arrow button ④ until the controller shows 200°F (93°C).
    - Press and release the button to change the holding temperature by one degree.
    - Press and hold the button to change the holding temperature by ten degrees.
 The heat indicator ② illuminates and preheat starts.
2. Wait thirty (30) minutes.
3. Place hot food in the holding cabinet.

### **WARNING**

Only food which has been heated to an internal temperature of 140°F to 160°F (60°C to 71°C) should be placed in the holding cabinet.

4. Select at least one food item in every pan and insert a food thermometer into the center to check internal temperature. Heat any food items which are below the minimum temperature before placing them in the holding cabinet.
5. Close the holding cabinet door securely.
6. Press the down arrow button ④ until the controller shows 160°F (71°C).
  - a) Press and release the button to change the holding temperature by one degree.
  - b) Press and hold the button to change the holding temperature by ten degrees.

### How to Display Set-Point or Actual Holding Temperature

**NOTE:** The factory default is the set-point holding temperature.

Press and hold the temperature display button ③ and the up arrow button ⑤ simultaneously, for five (5) seconds.

The controller shows “ACT” for Actual compartment temperature, or “SET” for the Set-point holding temperature, and then the selected temperature.

**NOTE:** Press the temperature display button ③ at any time to temporarily display the alternate temperature.

### How to Change Controller from Fahrenheit to Celsius

**NOTE:** The factory default is Fahrenheit.

Press and hold the temperature display button ③ and the down arrow button ④ simultaneously, for five (5) seconds.

The controller shows °C for Celsius or °F for Fahrenheit, then the temperature at the selected setting.

**NOTE:** The last selected setting is retained by the control board if there is a power failure.

### SureTemp™ Heat Recovery

The patented SureTemp™ heat recovery system in this appliance will immediately compensate for any loss of heat when the door is opened. In order to maintain a more consistent compartment temperature, the control will automatically apply heat to the appliance’s interior while the door is open and for a short time after the door is closed. If the door remains open for more than three minutes, the control will sound three rapid beeps every ten seconds until the door is closed.

## Deluxe Control

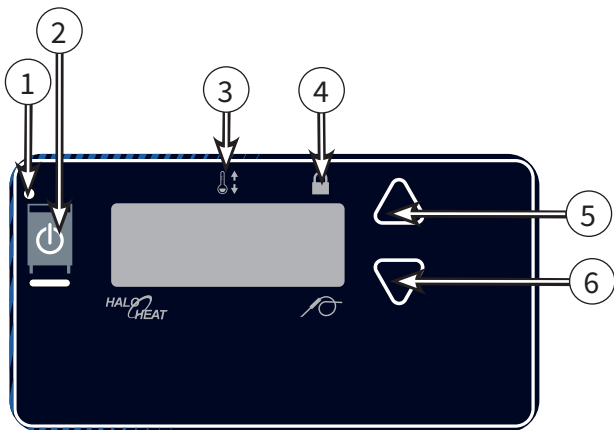

1. Preheat the holding cabinet at 200°F (93°C) for 30 minutes before loading hot food.
  - a) Press the ON/OFF button ②. The ON/OFF status indicator ① will illuminate.  
To reduce preheat time, rotate the vents inside the door to close them.
  - b) Press the up arrow button ⑤ or the down arrow button ⑥ until the controller shows 200°F (93°C).
    - Press and release the button to change the holding temperature by one degree.
    - Press and hold the button to change the holding temperature by ten degrees.
 The heat indicator ③ illuminates and preheat starts.
2. Wait thirty (30) minutes.
3. Place hot food in the holding cabinet.

WARNING

Only food which has been heated to an internal temperature of 140°F to 160°F (60°C to 71°C) should be placed in the holding cabinet.

4. Select at least one food item in every pan and insert a food thermometer into the center to check internal temperature. Heat any food items which are below the minimum temperature before placing them in the holding cabinet.
5. Close the holding cabinet door securely.

6. Press the down arrow button ⑥ until the controller shows 160°F (71°C).
  - Press and release the button to change the holding temperature by one degree.
  - Press and hold the button to change the holding temperature by ten degrees.

### How to Display Set-Point and Actual Holding Temperature

To display the actual compartment temperature, press the up arrow button ⑤. The actual compartment temperature will display for a short time and then the controller will return to the set-point holding temperature.

### How to Change Controller from Fahrenheit to Celsius

**NOTE:** The factory default is Fahrenheit.

With the controller OFF, press and hold the up arrow button ⑤ until the controller shows °C.

Press either arrow button to change from °C to °F.

**NOTE:** The last selected setting is retained by the control board if there is a power failure.

### How to Enable/Disable the Beeper

**NOTE:** The factory default is ON.

With the controller OFF, press and hold the down arrow button ⑥. The controller will display “OFF”.

Press either arrow button to turn the Beeper on.

### How to Lock the Controller

The controller lock prohibits the set temperature from being changed.

Press and hold the ON/OFF button ② and the up arrow button ⑤ simultaneously. The lock status indicator ⑤ will illuminate.

To unlock the controller, press and hold the ON/OFF button ② and the down arrow button ⑥ simultaneously. The lock status indicator ⑤ will go out.

### Deluxe Control Shelf Timers (option)

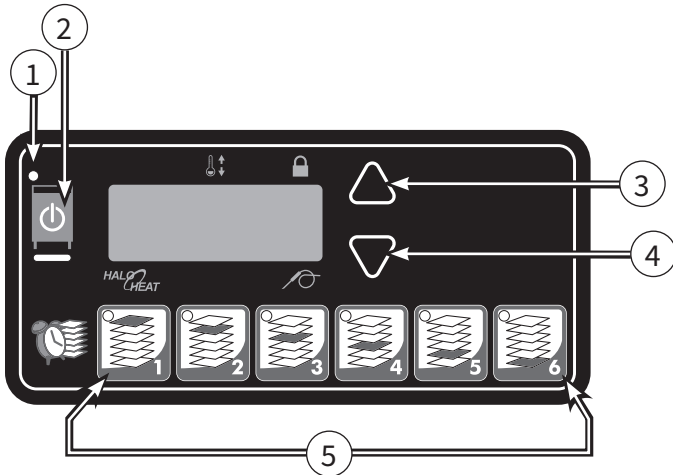

The shelf timers monitor food safety by using a first item in, first item out product management system. Holding times can be set for the products in each of the shelf positions. Products must be cooked to HACCP recommended internal temperature before being held in the holding cabinet.

#### How to Set the Shelf Timers

1. Press and hold the ON/OFF button (2) until the controller and power indicator (1) go out.
2. Press and hold the shelf timer button (5) until the controller shows the countdown time.
3. Press the up arrow button (3) or down arrow button (4) to set the desired holding time.

The holding time will display as HH:MM.

4. Repeat steps 2 and 3 for each shelf to be timed.

#### How to Proof Dough

With the addition of a pan of water, this holding cabinet can be used for proofing dough. A water reservoir pan (#1775) and pan cover (#1774) is available as an accessory from Alto-Shaam.

1. Remove dough from retarder or refrigerator and allow covered dough to come to room temperature.
2. Set holding temperature to 95°F (35°C).
3. Pour approximately 2 quarts (c. 2 liters) of 140°F to 180°F (60°C to 82°C) water into the optional water reservoir pan and place the pan on the bottom surface of the compartment.
4. Preheat holding cabinet for 45 to 60 minutes.
5. Remove covering and place dough in preheated holding cabinet.
6. Allow dough to remain in the holding cabinet until it nearly doubles in size.
7. Remove dough from the holding cabinet and bake according to product manufacturer's directions. Brush with egg wash if desired.

**NOTE:** The above proofing procedure is a suggested guideline only. Due to variation from product to product, including quality and product weight, close adherence the product manufacturer's instructions is strongly recommended.

#### How to Use the Shelf Timers

1. Press and hold the ON/OFF button (2) until the controller and power indicator (1) illuminate.
2. Press the desired shelf timer button (5).

The shelf timer button (5) will illuminate and the count down will begin. The controller will display as HH:MM when the remaining time is more than 60 minutes. It will display as MM:SS when the remaining time is less than 60 minutes.

When the shelf time has expired, the shelf timer button (5) will flash quickly. Press the button to acknowledge expired timer.

The timer with the shortest amount of time remaining will flash slowly.

To cancel a shelf timer, press and hold the shelf timer button (5) for two (2) seconds.

# Cleaning and Preventative Maintenance

 **WARNING**

 To prevent serious personal injury, death, or property damage:

**Do not** steam clean, hose down or flood the interior or exterior with water or liquid solution of any kind. **Do not** use water jet to clean. Failure to observe this precaution will void the warranty.

 **WARNING**

 To prevent serious injury, death, or property damage, **always** disconnect the appliance from the power source before cleaning or servicing.

## How to Clean the Holding Cabinet

1. Disconnect appliance from the power source. Let appliance cool.
  2. After the appliance has cooled, remove and wash wire shelves, side racks/pan slides, drip tray, and drip pan with hot soapy water.
  3. Wipe the interior of the holding cabinet with a paper towel to remove loose food debris.
  4. Clean the interior with a damp clean cloth or sponge and any good commercial detergent.
 

**NOTICE:** Never use abrasive cleaning compounds, chloride-based cleaners, or cleaners containing quaternary salts. Never use hydrochloric acid (muriatic acid) on stainless steel.
  5. Spray heavily soiled areas with a water soluble degreaser and let stand for 10 minutes, then remove soil with a plastic scouring pad.
  6. Wipe the control panel, door vents, door handles, and door gaskets.
  7. Rinse surfaces by wiping with a sponge and clean warm water.
  8. Remove excess water with a sponge and wipe dry with a clean cloth or air dry. Leave door(s) open until interior is completely dry.
  9. Wipe the interior with a sanitizing solution that is approved for use on stainless steel food contact surfaces.
  10. Replace the side racks/pan slides, drip tray, drip pan and shelves.
 

**NOTE:** Shelves must be installed with the curved end up and toward the back of the compartment.
  11. Spray a clean cloth with a cleaning solution approved for stainless steel and wipe the exterior of the cabinet.
  12. Clean door glass with glass cleaner or distilled vinegar.
- Always follow appropriate state or local health (hygiene) regulations regarding all applicable cleaning and sanitation requirements for food service equipment.

# Cleaning and Preventative Maintenance

<b>Preventative Maintenance Checklist</b>	
<b>Daily</b>	
	Perform daily cavity cleaning as stated in the cleaning section of this manual
	Clean out the front drip tray
<b>Monthly</b>	
	Inspect door gasket
	Inspect door window gasket
	Inspect cavity door vent slides for proper operation
	Inspect side racks, shelves and shelf supports to ensure nothing is damaged or in need of replacement
	Calibrate removable product probe
	Clean out cooling fan intake and exhaust vents
<b>Every 12 months (Inspection by a factory authorized technician)</b>	
	Open control area and inspect/tighten all wiring
	Inspect all electrical components
	Test elements for electrical short to ground. Replace/repair as needed.
	Visually inspect the cavity for structural integrity
	Inspect door gasket. Replace if needed.
	Visually inspect any door handles and hinges. Replace/repair as needed.
	Remove any loose handle and hinge screws. Then properly secure the screws using Loctite.
	Inspect and test product probe and product probe receptacle (where applicable)
	Inspect and test control and control functions
	Inspect casters. Repair/replace as needed.
	Inspect perimeter bumper. Repair/replace as needed.
	Inspect power cord. Tighten cord connection inside the appliance control area
	Perform cavity temperature calibration per manufacturer's recommended calibration procedures
	Check site voltage
	Confirm proper current draw of heating pads

**WARNING**

Electric shock hazard.

Perform lockout/tagout procedures before cleaning or servicing this appliance.

This section is provided for the assistance of qualified and trained service technicians only and is not intended for use by untrained or unauthorized service personnel. Failure to observe this precaution may void the warranty.

## Thermostat Accuracy

To verify that the compartment temperature matches the temperature displayed on the controller:

1. Ensure the appliance voltage matches the power source.
2. With the exception of the wire shelves, completely empty the holding cabinet.
3. Ensure the air temperature sensor, located inside the holding compartment is completely clean.
4. Suspend a quality thermometer from the center of the holding compartment.
5. Close cabinet door and set the holding temperature anywhere between 60°F and 200°F (16°C to 93°C).
6. Allow the temperature to stabilize for a minimum of one hour.

**Do not open the cabinet door(s) during the temperature stabilization period.**

7. Compare the temperature displayed on the controller with the reading on the thermometer.  
If the reading on the thermometer does not match the temperature on the controller, the air sensor may be faulty.

## How to verify sensor integrity

Place the sensor in ice water. Test with an ohmmeter set to the ohm scale.









Air sensor	1000 ohms ± 20
Air sensor (Deluxe control)	100 ohms ± 2

If the reading is more or less than above parameters, replace sensor.









**Always** verify that the circuit breaker is turned to the On position and your appliance is receiving power **before** calling your authorized Alto-Shaam Service Agent.

Code	Description	Possible Causes
E-10	<b>Cavity air sensor shorted</b>	Cavity air sensor reading < 5°F (-15°C). Verify sensor integrity.
E-11	<b>Cavity air sensor open</b>	Cavity air sensor reading > 517°F (269°C). Verify sensor integrity.
E-20	<b>Product probe is shorted</b> <i>Oven will cook in time only</i>	Product probe reading < 5°F (-15°C). Verify sensor integrity.
E-21	<b>Product probe is open</b> <i>Oven will cook in time only</i>	Product Probe reading > 517°F (269°C). Verify sensor integrity.
E-30	<b>Under temperature</b>	Unit has been more than 25°F (14°C) below set point for longer than 90 minutes.
E-31	<b>Over temperature</b>	Unit has been more than 60°F (33°C) above the maximum set-point for longer than 3 minutes. Holding Cabinets with this error code are more than 145°F (81°C) above the maximum set-point.
E-32	<b>Safety switch open (Aux hi-limit switch)</b>	Contact factory.
E-38	<b>Internal software error</b>	Contact factory.
E-39	<b>Sensor error</b>	Contact factory.
E-50	<b>Temp. measurement error</b>	Contact factory.
E-51	<b>Temp. measurement error</b>	Contact factory.
E-60	<b>Real time clock error</b>	Data set to factory default. Ensure that date and time are correct if applicable.
E-61	<b>Real time clock error</b>	Contact factory.
E-64	<b>Clock is not oscillating</b>	Contact factory.
E-70	<b>Configuration connector error (DIP switch)</b>	Refer to the electrical schematic and ensure dip switches on the control match the settings called out on the schematic. If the dip switch settings are correct, according to the schematic, replace the control.
E-78	<b>Voltage low</b>	Voltage below 90 VAC on a 125 VAC unit, or below 190 VAC on a 208-240 VAC unit. Adjust DC voltage. See "How to Adjust DC Voltage" in this manual.
E-79	<b>Voltage high</b>	Voltage over 135 VAC on a 125 VAC unit, or over 250 VAC on a 208-240 VAC unit. Adjust DC voltage. See "How to Adjust DC Voltage" in this manual.
E-80	<b>EEPROM Error</b>	Ensure that all temperatures and times are properly set. Contact factory if problem persists.
E-81	<b>EEPROM Error</b>	Contact factory.
E-82	<b>EEPROM Error</b>	Contact factory.
E-83	<b>EEPROM Error</b>	Contact factory.
E-85	<b>EEPROM Error</b>	All timers, if previously on, are now off. Possible bad EEPROM.
E-86	<b>EEPROM Error</b>	Stored HACCP memory corrupted. HACCP Address reset to 1. Possible bad EEPROM. Contact factory if problem persists.
E-87	<b>EEPROM Error</b>	Stored offsets corrupted. Offsets reset to 0. Control may need a recalibration. Possible bad EEPROM. Contact factory if problem persists.
E-88	<b>EEPROM Error</b>	All timer set-points are reset to 1 minute. Timers, if previously on, are now off. Possible bad EEPROM.
E-90	<b>Button stuck</b>	A button has been held down for > 60 seconds. Adjust control. Error will reset when the problem has been resolved.
E-91	<b>Input failure</b>	Contact factory.
E-dS	<b>Datakey error</b>	Datakey digital signature incompatible. Cycle power, and install compatible Datakey if error persists.
E-dT	<b>Datakey error</b>	Datakey incompatible with control. Install compatible Datakey.
E-dU	<b>Datakey unplugged</b>	Install Datakey and cycle power to control to clear error.
dLto	<b>Datalogger has timed out</b>	Cycle power. Contact factory if error persists.
dLSD	<b>Micro SD card not plugged in</b>	Plug in SD card and cycle power. Contact factory if error persists.
<b>NOTE:</b> If in doubt, always cycle the power to the control and contact factory if the problem persists.		

For the most current schematics, use the QR code or click link.

<p><b>77194</b> 300, 500, 750, 1000, 1200-S 120V 60Hz</p>		
<p><b>77195</b> 300, 500, 750, 1000, 1200-S 208-240V 60Hz</p>		
<p><b>77196</b> 300, 500, 750, 1000, 1200-S 230V 50Hz</p>		
<p><b>7862</b> 500, 750, 1000, 1200-S 120V 60Hz</p>		
<p><b>77075</b> 500, 750, 1000, 1200-S 208-240V 60Hz</p>		
<p><b>7863</b> 500, 750, 1000, 1200-S 230V 50Hz</p>		
<p><b>77190</b> 1000 &amp; 1200-UP/UPS 120V 60Hz</p>		
<p><b>77191</b> 1000 &amp; 1200-UP/UPS 208-240V 60Hz</p>		
<p><b>77192</b> 1000 &amp; 1200-UP/UPS 230V 50Hz</p>		
<p><b>77091</b> 1000-UP/UPS 120V 60Hz</p>		

For the most current schematics, use the QR code or click link.

<p><b>77093</b> 1000-UP/UPS 208-240V 60Hz</p>		
<p><b>77089</b> 1000-UP/UPS 230V 50Hz</p>		
<p><b>77187</b> 1200-UP/UPS 120V 60Hz</p>		
<p><b>77088</b> 1200-UP/UPS 208-240V 60Hz</p>		
<p><b>77171</b> 1200-UP/UPS 230V 50Hz</p>		

## Warranty

---

### Introduction

Alto-Shaam, Inc. warrants to the original purchaser only, that any original part found to be defective in material or workmanship will be replaced with a new or rebuilt part at Alto-Shaam's option, subject to provisions hereinafter stated.

---

### Warranty Period

The original parts warranty period is as follows:

- For all other original parts, one (1) year from the date of installation of appliance or fifteen (15) months from the shipping date, whichever occurs first.
  - The labor warranty period is one (1) year from the date of installation or fifteen (15) months from the shipping date, whichever occurs first.
  - Alto-Shaam will bear normal labor charges performed during standard business hours, excluding overtime, holiday rates or any additional fees.
  - For the refrigeration compressor, if installed, the warranty period is five (5) years from the date of original installation of the appliance.
  - For heating elements on Halo Heat<sup>®</sup> Cook and Hold ovens, the warranty period is for as long as the original owner owns the oven. This warranty period applies to units sold after 2/1/2009 and excludes holding-only ovens.
  - To be valid, a warranty claim must be asserted during the applicable warranty period. This warranty is not transferable.
- 

### Exclusions

This warranty does not apply to:

- Calibration.
  - Replacement of light bulbs, rubber gaskets, grease filters, air filters, racks, jet plates, and/or the replacement of glass due to damage of any kind.
  - Equipment damage caused by accident, shipping, improper installation or alteration.
  - Equipment used under conditions of abuse, misuse, carelessness or abnormal conditions, including but not limited to, equipment subjected to harsh or inappropriate chemicals, including but not limited to, compounds containing chloride or quaternary salts, poor water quality, or equipment with missing or altered serial numbers.
  - Equipment damage caused by use of any cleaning agents other than those recommended by Alto-Shaam, including but not limited to damage due to chlorine or other harmful chemicals.
  - Any losses or damage resulting from malfunction, including loss of food product, revenue, or consequential or incidental damages of any kind.
  - Equipment modified in any manner from original model, substitution of parts other than factory authorized parts, unauthorized removal of any parts including legs, or unauthorized addition of any parts.
  - Equipment damage incurred as a direct result of poor water quality\*, inadequate maintenance of steam generators and/or surfaces affected by water. Water quality and required maintenance of steam generating equipment is the responsibility of the owner/operator.
  - Equipment damage incurred as a result of not following the required maintenance schedule published in the manuals for the equipment.
- 

### Conclusion

This warranty is exclusive and is in lieu of all other warranties, express or implied, including the implied warranties of merchantability and fitness for a particular purpose. No person except an officer of Alto-Shaam, Inc. is authorized to modify this warranty or to incur on behalf of Alto-Shaam any other obligation or liability in connection with Alto-Shaam equipment.

*\*Refer to the product spec sheet for water quality standards.*





# ALTO-SHAAM.

Menomonee Falls, WI U.S.A.

Phone 800-558-8744 | +1-262-251-3800 | alto-shaam.com

## ASIA

Shanghai, China  
Phone +86-21-6173-0336

## AUSTRALIA

Brisbane, Queensland  
Phone 800-558-8744

## CANADA

Concord, Ontario Canada  
Toll Free Phone 866-577-4484  
Phone +1-905-660-6781

## FRANCE

Aix en Provence, France  
Phone +33(0)4-88-78-21-73

## GMBH

Bochum, Germany  
Phone +49 (0)234 298798-0

## ITALY

Padua, Italy  
Phone +39 3476073504

## INDIA

Pune, India  
Phone +91 9657516999

## MEXICO

Phone +52 1 477-717-3108

## MIDDLE EAST & AFRICA

Dubai, UAE  
Phone +971-4-321-9712

## CENTRAL & SOUTH AMERICA

Miami, FL USA  
Phone +1 954-655-5727