

# ALTO SHAAM® Retherm & Food Holding Oven

## Electronic or Manual Control



2800-RTM  
MANUAL CONTROL



2800/s-RTM  
MANUAL CONTROL  
OPTIONAL CASTERS



12•20-RTM/e  
ELECTRONIC  
CONTROL



### Models:

#### Manual Control

**12•20-RTM** WITH ROLL-IN CART

**2800-RTM**

**2800/s-RTM**

#### Electronic Control

**12•20-RTM/e** WITH ROLL-IN CART

**2800-RTM/e**

**2800/s-RTM/e**

- **INSTALLATION**
- **OPERATION**
- **MAINTENANCE**



W164 N9221 Water Street • P.O. Box 450 • Menomonee Falls, Wisconsin 53052-0450 USA

PHONE: 262.251.3800 • 800.558.8744 USA/CANADA

FAX: 262.251.7067 • 800.329.8744 U.S.A. ONLY

WEBSITE: [www.alto-shaam.com](http://www.alto-shaam.com)

# INDEX

## SECTION 1 - INSTALLATION

Delivery / Unpacking .....	1
Safety Procedures & Cautions .....	2
Site Installation / User Information .....	3
Electrical Installation .....	4
Stacking Instructions .....	5
Dimensions .....	5, 6
Product/Pan Capacity — Options & Accessories .....	7

## SECTION 2 - OPERATION

Manual Control	
Identification and Operation .....	8
Electronic Control	
Identification .....	9
Operation .....	10
Program Preset Keys .....	11
Setting the Internal Clock .....	12
Power Fail Detect .....	12
Operational Stop .....	12
Beeper Volume .....	12
Fahrenheit or Celsius Selection .....	12
Preset Keys Lock & Unlock .....	12
Control Panel Lock & Unlock .....	12
Audible Signals .....	13
Operating Features & Functions .....	13
Product Reheating Guidelines .....	14
General Holding Guidelines .....	15

## SECTION 3 - CARE AND CLEANING

Cleaning and Preventative Maintenance .....	16
Clean the Oven Daily .....	17
Roll-in Cart/Food Trolley Cleaning .....	18
Daily Gasket Cleaning .....	18
Sanitation Guidelines .....	19

## SECTION 4 - SERVICE

Service Parts List .....	20 thru 22
Service Views .....	23 thru 28
Cable Replacement Kit .....	29
Troubleshooting .....	30, 31
Wiring Diagrams .....	32 thru 39
Transportation Damage & Claims .....	40
Warranty .....	40

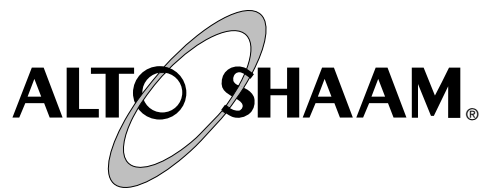

## DELIVERY

This Alto-Shaam appliance has been thoroughly tested and inspected to insure only the highest quality unit is provided. Upon receipt, check for any possible shipping damage and report it at once to the delivering carrier. *See Transportation Damage and Claims section located in this manual.*

This appliance, complete with unattached items and accessories, may have been delivered in one or more packages. Check to ensure that all standard items and options have been received with each model as ordered.

Save all the information and instructions packed with the appliance. Complete and return the warranty card to the factory as soon as possible to assure prompt service in the event of a warranty parts and labor claim.

This manual must be read and understood by all people using or installing the equipment model. Contact the Alto-Shaam service department if you have any questions concerning installation, operation, or maintenance.

**NOTE:** All claims for warranty must include the full model number and serial number of the unit.

## UNPACKING

1. Carefully remove the appliance from the carton or crate.

**NOTE:** Do not discard the carton and other packaging material until you have inspected the unit for hidden damage and tested it for proper operation.

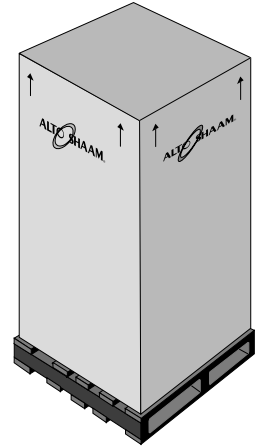

2. Read all instructions in this manual carefully before initiating the installation of this appliance.

### **DO NOT DISCARD THIS MANUAL.**

This manual is considered to be part of the appliance and is to be provided to the owner or manager of the business or to the person responsible for training operators. *Additional manuals are available from the Alto-Shaam service department.*

3. Remove all protective plastic film, packaging materials, and accessories from the appliance before connecting electrical power. Store any accessories in a convenient place for future use.

# SAFETY PROCEDURES AND PRECAUTIONS

Knowledge of proper procedures is essential to the safe operation of electrically and/or gas energized equipment. In accordance with generally accepted product safety labeling guidelines for potential hazards, the following signal words and symbols may be used throughout this manual.

 <b>DANGER</b>	Used to indicate the presence of a hazard that <b>will</b> cause severe personal injury, death, or substantial property damage if the warning included with this symbol is ignored.
---	---

 <b>WARNING</b>	Used to indicate the presence of a hazard that <b>can</b> cause personal injury, possible death, or major property damage if the warning included with this symbol is ignored.
--	--

 <b>CAUTION</b>	Used to indicate the presence of a hazard that can or will cause minor or moderate personal injury or property damage if the warning included with this symbol is ignored.
--	--

<b>CAUTION</b>	Used to indicate the presence of a hazard that can or will cause minor personal injury, property damage, or a potential unsafe practice if the warning included with this symbol is ignored.
----------------	--

<b>NOTE:</b>	Used to notify personnel of installation, operation, or maintenance information that is important but not hazard related.
--------------	---

1. This appliance is intended to cook, hold or process foods for the purpose of human consumption. No other use for this appliance is authorized or recommended.
2. This appliance is intended for use in commercial establishments where all operators are familiar with the purpose, limitations, and associated hazards of this appliance. Operating instructions and warnings must be read and understood by all operators and users.
3. Any troubleshooting guides, component views, and parts lists included in this manual are for general reference only and are intended for use by qualified technical personnel.
4. This manual should be considered a permanent part of this appliance. This manual and all supplied instructions, diagrams, schematics, parts lists, notices, and labels must remain with the appliance if the item is sold or moved to another location.

<b>NOTE</b>	
	<b>For equipment delivered for use in any location regulated by the following directive: DO NOT DISPOSE OF ELECTRICAL OR ELECTRONIC EQUIPMENT WITH OTHER MUNICIPAL WASTE.</b>

# INSTALLATION

## SITE INSTALLATION

The oven, complete with unattached items and accessories, may be delivered in one or more packages. Check to ensure that all the accessories ordered have been received with the oven.

This retherm and food holding oven is designed for the purpose of heating food to its proper temperature and maintaining the hot food at a temperature for safe consumption. It must be installed in a location that will permit it to function for its intended purpose and allow adequate access for proper cleaning and maintenance.

### CLEARANCE REQUIREMENTS

6-inches (152mm) at the back, top, and both sides

1. The oven should be installed on a stable and level surface. Level the appliance from side-to-side and back-to-back with the use of a spirit level.
2. DO NOT install the oven in any area where it may be affected by any adverse conditions like steam, grease, dripping water, high temperatures, etc.
3. DO NOT install adjacent to flammable surfaces.

### WEIGHT

2800/s-RTM	270 lbs (122 kg)
2800-RTM	384 lbs (174kg)



## CAUTION

TO PREVENT PERSONAL INJURY,  
USE CAUTION WHEN MOVING OR  
LEVELING THIS APPLIANCE.

### HEATING CHARACTERISTICS

The oven is equipped with a special, low heat density, heating cable. Through the Halo Heat concept, the heating cable is mounted against the walls of the oven compartment to provide an evenly applied heat source controlled by an electronic thermostat. Through even heat application, products are reheated to serving temperature from either a chilled or frozen state and the quality of a food product is maintained at a holding temperature up to as much as several hours.

## USER INFORMATION

### BEFORE INITIAL USE:

Clean both the interior and exterior of the cabinet with a damp cloth and mild soap solution. Rinse carefully.

Become familiar with the operation of the controls. Read this manual carefully and retain it for future reference. Alto-Shaam Retherm and Food Holding ovens have undergone extensive tests reheating individual meals, bulk convenience entrées, pre-cooked frozen items, and cooking a variety of raw foods at temperatures up to 400°F (204°C).

The design elements of this oven incorporate a series of fans to evenly distribute heat and reach temperature requirements quickly. This oven is best suited for school food service, healthcare satellite kitchens, catering, or any kitchen that is reheating individual meals or bulk food from a commissary. These meals usually consist of a casserole item such as lasagna, or a meat and starch item such as turkey with stuffing, and vegetables. Since these ovens are fully functioning ovens with high temperatures, a variety of items, such as cookies, chicken breasts, and frozen vegetables can also be cooked.

While Retherm and Food Holding ovens have both cooking and holding capabilities, using these ovens for roasting large cuts of meat is not recommended. The fans operate continuously during the retherm cycle. It is recommended to cover food to retain moisture and to maximize the holding times.

This retherm and holding oven has a distinct advantage over a convection oven. While each oven takes approximately the same time to cook or reheat, this oven automatically converts to a holding cabinet where an entire oven load can remain until serving time. **(The unit must remain connected to a electrical power source when in this holding stage.)** Since individual and bulk meals are reheated in covered containers, maximum holding life is achieved when operating these ovens with the type of precooked products suggested.

## CAUTION

TO MAINTAIN SAFE TEMPERATURE LEVELS,  
COLD FOOD FOR RETHERMALIZATION OR  
REHEATING MUST NEVER BE ADDED TO THE  
OVEN WHILE HOT FOODS ARE BEING HELD.

# INSTALLATION

## ELECTRICAL

1. An identification tag is permanently mounted on the exterior of the oven.

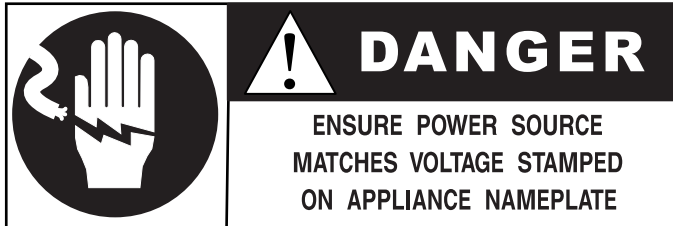

2. A proper receptacle or outlet configuration, as required for the oven, must be installed by a licensed electrician. The unit must be grounded in accordance with applicable local electric codes. In the U.S.A. the oven must be grounded in accordance with the National Electrical Code.
3. Means for disconnection must be incorporated in the fixed wiring in accordance with wiring rules.
4. Plug the unit into a properly grounded receptacle only, positioning the oven so that the supply cord is easily accessible in case of an emergency. Arcing will occur when connecting or disconnecting the unit unless all controls are in the "OFF" position.

**230V units:** To prevent an electrical shock hazard between the appliance and other appliances or metal parts in close vicinity, an equalization-bonding stud is provided. An equalization bonding lead must be connected to this stud and the other appliances / metal parts to provide sufficient protection against potential difference. The terminal is marked with the following symbol.



**NOTE:** The appliance must be connected to an electrical circuit that is protected by an external GFCI outlet.



### NOTE:

380V 3 phase units are furnished with two electrical cords. The larger cord is used when a 380V 3 phase power source is available during rethermalization or holding functions. The smaller power cord is used after moving the oven to a holding area where a lower voltage receptacle is available for hot food *holding only*.

Each cord is furnished with an individual ON/OFF circuit breaker switch located at the back next to the cord. Remember to turn ON the power for the appropriate electrical cord.

**Never plug in both cords at the same time.  
Electrical damage could occur.**

This feature is provided as a customer convenience when the oven is to be moved to a separate *holding* area (following product rethermalization) where a 380V 3 phase power source is usually not available.



Retherm Switch

Retherm Cord

Holding Cord

Holding Switch

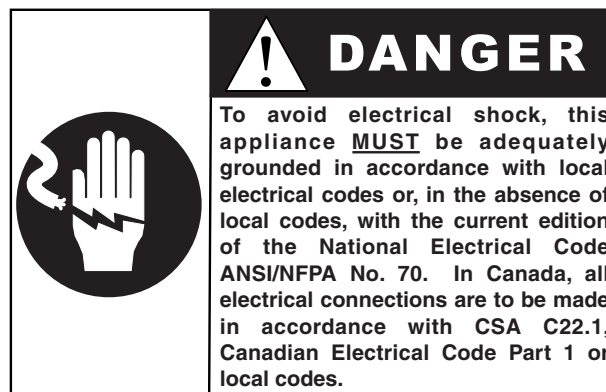

# INSTALLATION

## STACKING INSTRUCTIONS

## DIMENSIONS

Model 2800/s-RTM MANUAL CONTROL

Model 2800/s-RTM/e ELECTRONIC CONTROL

OVEN STACKING KIT 5001115  
(OPTION)

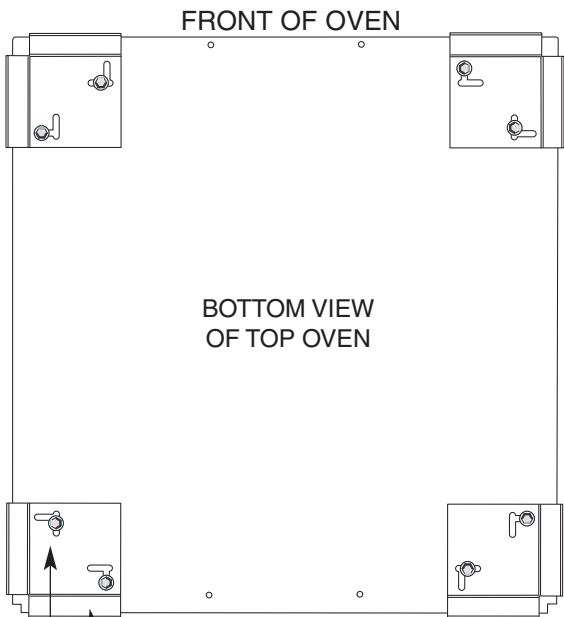

- 4: Stacking Hardware Corners
- 8: Serr. Hex Head Screws SC-2351

Fasten stacking corners to bottom of oven using 2: 5/16-189 serr. hex hd screws on each corner.

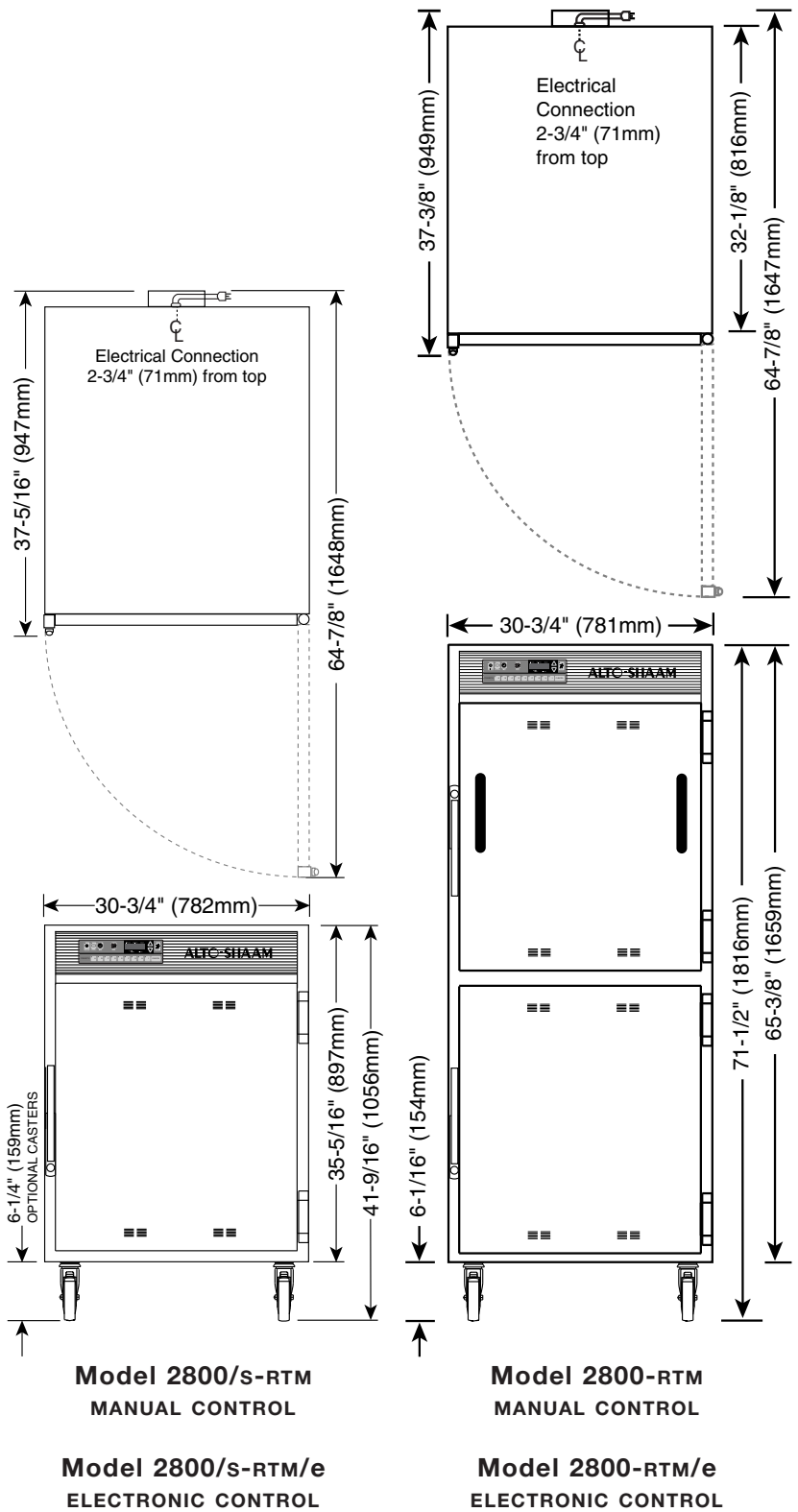

# INSTALLATION

## DIMENSIONS

**Model 12•20-RTM**  
**MANUAL CONTROL**  
**WITH ROLL-IN CART**

**Model 12•20-RTM/e**  
**ELECTRONIC CONTROL**  
**WITH ROLL-IN CART**

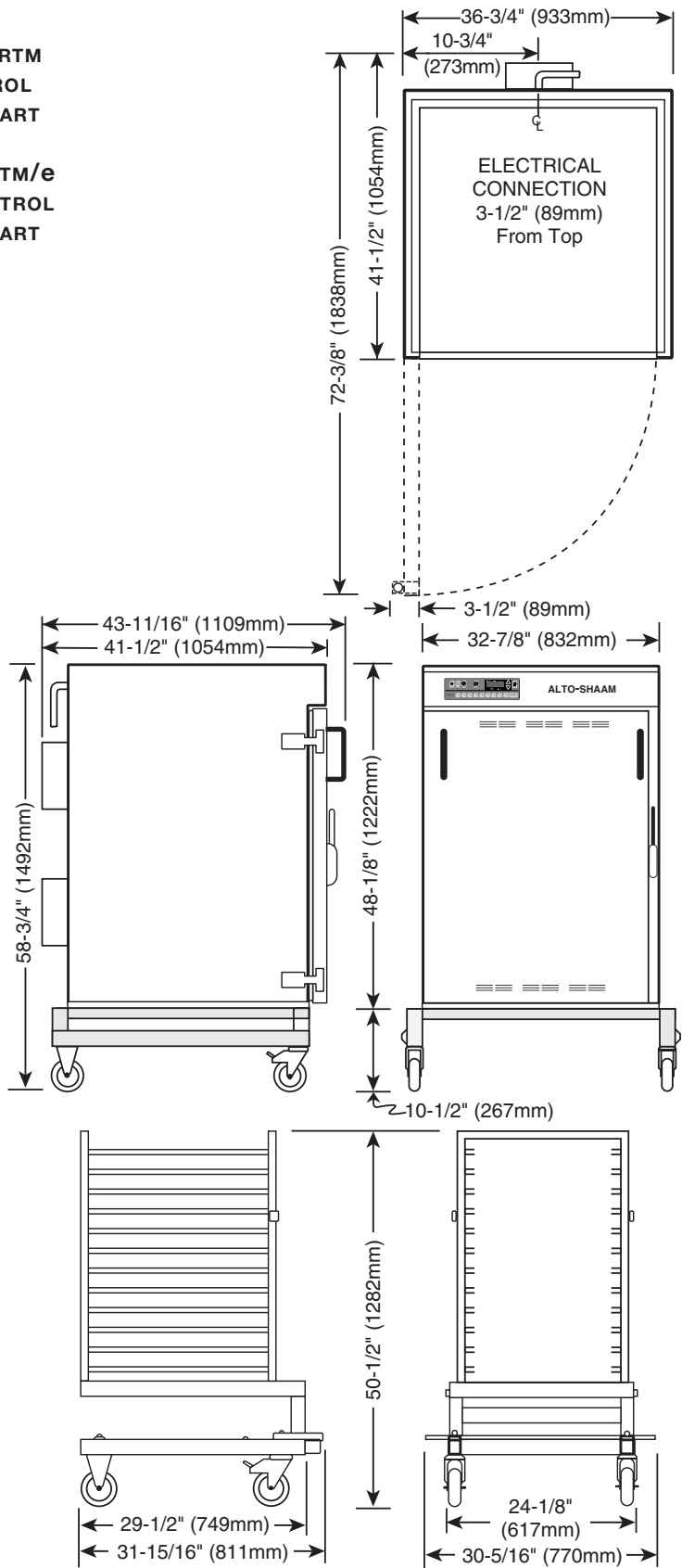

# INSTALLATION

## PRODUCT/PAN CAPACITY

	12•20-RTM	2800-RTM	2800/S-RTM
<b>MAXIMUM</b>	288 lbs (131 kg)	384 lbs (174 kg)	192 lbs (87 kg)
<b>VOLUME MAXIMUM</b>	180 QTS (228 L)	240 QTS (304 L)	120 QTS (152 L)
<b>FULL-SIZE PANS</b>			
20" x 12" x 2-1/2" (GN 1/1)	24	32	16
<b>FULL-SIZE SHEET PANS</b>			
18" x 26" x 1"	12*	16	8
<b>WIRE ENTRÉE BASKETS # 47</b>			
13" x 26" (330mm x 660mm)	--	32	16
ENTRÉE PANS PER BASKET		10	10
ENTREE PER UNIT	--	320	160
<b>WIRE ENTREE BASKETS # 53</b>			
13" x 20" (330mm x 508mm)	26	32	16
ENTRÉE PANS PER BASKET	8	8	8
ENTREE PER UNIT	--	256	128
ENTRÉE PANS PER CART	208	--	--
ENTRÉE PAN SIZE: 6-1/2" x 5" (165mm x 127mm) <span style="float: right;">*with optional shelves</span>			

## OPTIONS & ACCESSORIES

	12•20	2800-RTM	2800/S-RTM
DESCRIPTION	SERIES	SERIES	SERIES
HACCP Network Options (ELECTRONIC CONTROL ONLY)			
REFER TO SPECIFICATION #9015, DATED 10/05 OR AFTER FOR APPLICABLE PART NUMBERS			
HACCP Documentation			
HACCP with Kitchen Management			
Baskets, s/s wire entree #53 - 13" x 20" (330mm x 508mm)	BS-25591	BS-25591	BS-25591
#47 - 13" x 26" (330mm x 660mm)	--	BS-25592	BS-25592
#47C - 18" x 26" (457mm x 660mm)	--	BS-27765	BS-27765
Bumper, full perimeter assembly with 5" (127mm) casters	--	5001159	5001159
Cart, roll-in (trolley) with removable pan rail supports	5000723	--	--
Cart, roll-in (trolley) included as standard	5814	--	--
Casters, 5" (127mm)	INCLUDED	INCLUDED	4007
Probe, internal product temp., ELECTRONIC CONTROL ONLY	AVAILABLE	AVAILABLE	AVAILABLE
Legs, 6" (152mm)	--	5205	5205
Preheat Sealing Strip	1000664	--	--
Shelves, stainless steel wire	SH-22473	--	--
Stacking Hardware	--	--	5001115

## CAUTION

TO MAINTAIN SAFE TEMPERATURE LEVELS, COLD FOOD FOR RETHERMALIZATION OR REHEATING MUST NEVER BE ADDED TO THE OVEN WHILE HOT FOODS ARE BEING HELD.

# MANUAL CONTROL • OPERATION

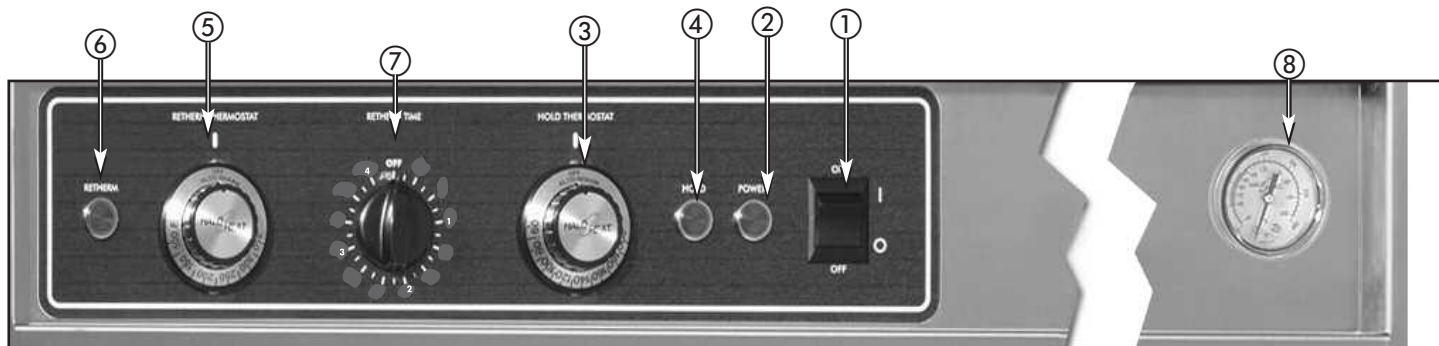

Make sure the proper electrical cord is connected to the appropriate power source, and the circuit breaker is on.

## CONTROL IDENTIFICATION

### ① ON/OFF POWER SWITCH

The ON/OFF power switch provides access to operation of the control system.

→ The power ON indicator light ② will illuminate and will remain lit as long as the power switch is ON I. To disengage power, press the power switch to the OFF O position and the ON/OFF indicator light will go out.

### ③ HOLD THERMOSTAT

The HOLD THERMOSTAT has a temperature range of 60° to 240°F (16° to 116°C).

→ The holding indicator light ④ will illuminate when the hold thermostat is turned clockwise from the OFF position to an operator set temperature. The holding indicator light will cycle ON and OFF as the hold thermostat calls for heat. This process will continue as long as the hold thermostat is engaged.

### ⑤ RETHERM THERMOSTAT

The RETHERM THERMOSTAT has a temperature range of 100° to 400°F (38° to 204°C).

→ The retherm indicator light ⑥ will illuminate when the timer ⑦ is advanced clockwise. The retherm indicator light will cycle ON and OFF as the retherm thermostat calls for heat.

### ⑦ RETHERM TIMER (4 hour maximum)

When advanced clockwise, the RETHERM TIMER will engage the retherm thermostat which will remain active until the timer is rotated or cycles to the OFF position.

### ⑧ HOLDING TEMPERATURE GAUGE

The HOLDING TEMPERATURE GAUGE reflects the air temperature inside the cabinet.

## MANUAL CONTROL OPERATION

1. Press the ON/OFF power key ① to the ON position. The power ON indicator light ② will illuminate. To disengage power, press the power switch to the OFF position and the ON/OFF indicator light will go out.
2. Turn the RETHERM THERMOSTAT ⑤ clockwise to the reheating temperature desired.
3. Turn the HOLD THERMOSTAT ③ clockwise to the holding temperature desired for the reheated product.
4. Preheat the oven by advancing the TIMER knob ⑦ clockwise to activate the Retherm Thermostat. Allow the oven to preheat until the “RETERM” indicator light goes out.
5. Load product.
6. **RESET TIMER TO THE CORRECT PERIOD OF RETHERM TIME.** (4 hour maximum)
  - A. To set time, turn the timer knob past the required time period then immediately bring it back to the correct setting.
  - B. Refer to individual cooking instructions for length of time necessary to retherm.
  - C. When timer cycles to the “OFF” position, the oven temperature automatically lowers to the selected “HOLD” temperature.
  - D. The internal temperature of the product will continue to increase as the oven temperature lowers to the selected holding temperature.



## CAUTION

IF A POWER FAILURE OCCURS, FOLLOW LOCAL HEALTH (HYGIENE) REGULATIONS TO MAKE CERTAIN THE FOOD PRODUCT IN THE RETHERM OVEN REMAINS SAFE FOR HUMAN CONSUMPTION.

# ELECTRONIC CONTROL • OPERATION

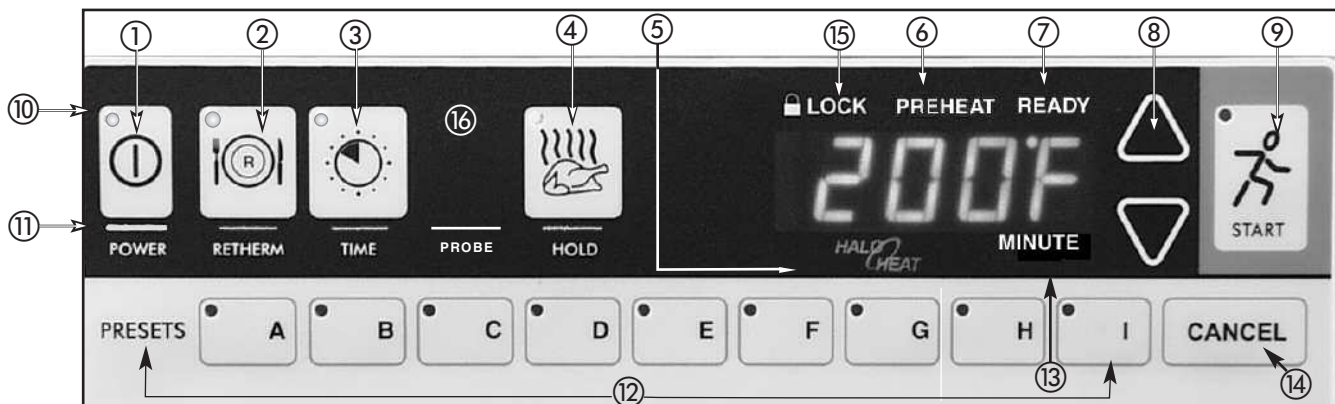

## ① ON/OFF POWER KEY

The ON/OFF power key provides access to operation of the control system. Press the ON/OFF power key to energize the control. The power ON indicator light will illuminate. To disengage power, press and hold the ON/OFF key for four seconds. An audible signal will sound and the ON/OFF indicator light will go out.

If there is a power loss during operation, the ON/OFF key light will flash. To clear a flashing ON/OFF key indicator, press and release the power key. (See Power Fail Detect paragraph for additional information).

## ② RETHERM KEY

The retherm or regeneration key provides the operator with a temperature range setting of 100°F to 400°F (38°C to 204°C).

## ③ TIME KEY

Used to select retherm time up to a maximum of 24 hours and to review operator set time.

## ④ HOLD KEY

Provides the operator with the a hot food holding temperature range of 60°F to 205°F (16°C to 96°C). Press the hold key and use the up and down arrow keys to adjust the holding temperature. Press and hold this key to review the operator set holding temperature.

## ⑤ HALO HEAT INDICATOR

The Halo Heat indicator light will illuminate during the preheating cycle and will remain lit until the oven reaches the operator set retherm temperature. Once the set temperature has been reached, the Halo Heat indicator will illuminate periodically as the unit calls for heat.

## ⑥ PREHEAT INDICATOR

The preheat indicator will illuminate until the retherm oven reaches the operator set temperature.

## ⑦ READY INDICATOR

The ready indicator will illuminate when the preheat temperature has been reached and the retherm oven is ready for product loading.

The ready indicator will illuminate again when the retherm time has expired and the temperature decreases from the retherm temperature to the holding temperature.

## ⑧ UP/DOWN ARROW KEYS

The arrow keys function to adjust the set temperature of the retherm mode and the hold mode. With the oven

power ON, press the required mode key followed by the up or down arrow key to adjust the temperature in increments of 1-degree. Press and hold the mode key while pressing the up or down arrow key to adjust the temperature in increments of 10-degrees.

The arrow keys also function to adjust the set time. With the oven power ON, press time time key followed by the up or down arrow key to adjust the time in increments of 1-minute. Press and hold the time key and the up or down arrow key to adjust the time in increments of 10 minutes.

## ⑨ START KEY

The start key is used to start or stop a retherm operation. Press and release the start key to initiate a selected mode sequence. Press and hold the start key to stop a selected mode sequence. Release the key when an audible signal is heard.

## ⑩ GREEN INDICATOR LIGHTS

Located within each function key, the green indicators identify the current mode of operation. These indicators also function as an operator prompt to initiate additional action on the part of the operator.

## ⑪ AMBER INDICATOR LIGHTS

Located below each function key, the amber indicators identify the current mode of operation. These indicators also allow the operator to identify the current LED display information.

## ⑫ PRESET PROGRAM KEYS

Keys A through H provides memory storage and operating function for up to eight individual operator set retherm programs. The I key enables the program key locking function.

## ⑬ OVEN DISPLAY

Indicates set preheat temperature, retherm time, holding temperature, and a countdown of remaining time.

## ⑭ CANCEL KEY

The cancel key erases a program from stored memory.

## ⑮ LOCK KEY

Indicates settings used in retherm are locked.

## ⑯ PROBE KEY (optional)

Used to select and review internal product probe temperature setting.

# ELECTRONIC • BASIC OPERATION



Make sure the proper electrical cord is connected to the appropriate power source, and the circuit breaker is switched on.

## REHERM BY TIME (or PROBE if equipped):

1. Press the *Control Power* key ON.
2. Press the *Retherm* key. The last operator set retherm temperature will appear in the display. To change the retherm temperature, press the *Up* or *Down* arrow keys.
3. Press *Time* key (or optional *Probe* key ). The last operator set time will appear in the display. To change the retherm (or probe) time, press the Up or Down arrow keys.
4. Press *Hold* key. The last operator set holding temperature will appear in the display. To change the holding temperature, press the Up or Down arrow keys.
5. Wait for the *Ready* indicator to illuminate.

The Retherm oven is automatically programmed to preheat to the retherm temperature. When the unit has finished preheating, a triple beep will sound every 30 seconds. Both the Ready and Start indicator lights will flash.

6. Load food products inside the retherm oven and securely close the oven door.
7. Press the *Start Key*.

To view the temperature inside the oven compartment, press and hold the *Hold* key.

## REHERM WITH PRESET MENU KEYS:

1. Press the *Control Power* key ON.
2. Press the selected *Preset* program key.

A green Preset Program key indicator light will illuminate in the upper left-hand corner of a lettered key when the key has been programmed.

### SEE FOLLOWING PAGE FOR PROGRAMMING INSTRUCTIONS.

3. Wait for the *Ready* indicator to illuminate.

The Retherm oven will automatically preheat to the programmed retherm temperature. When the unit has finished preheating, a triple beep will sound every 30 seconds. Both the Ready and Start indicator lights will flash.

4. Load food products inside the retherm oven and securely close the oven door.
5. Press the *Start Key*.

To view the temperature inside the oven compartment, press and hold the *Hold* key.

# ELECTRONIC • PROGRAM PRESET KEYS

## PRESET MENU KEYS

This Alto-Shaam Retherm oven allows the operator to set up to eight retherm programs. Each program can be preset in any program mode to retherm by time or by internal temperature. Programs are recalled and stored using the *Preset* keys labeled “A through H”. These keys, along with the key labeled “I”, share additional functions described in the operation section of this manual.

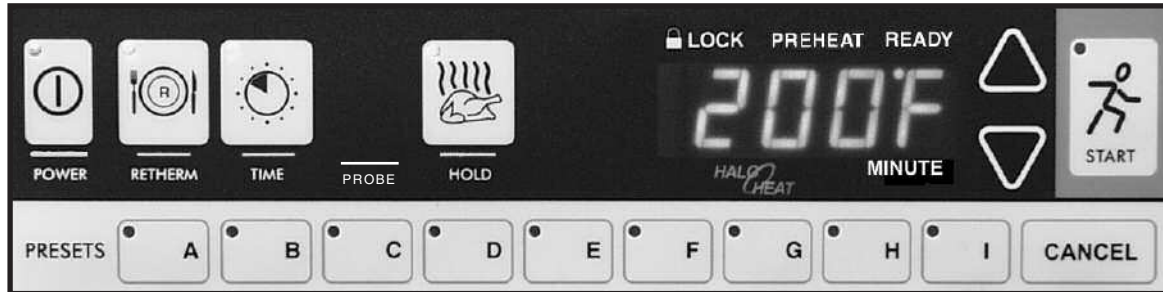

## PROGRAMMING A RETHERM PROGRAM

Prior to this procedure make sure the oven is “OFF”. Select the food product to be programmed. Press and release control *On/ Off* key. The oven will beep for one second and power to the unit will be indicated by an illuminated green indicator light located in the upper left corner of the *On/ Off* key. The oven will begin operating in the hold mode. The amber *Hold* indicator will be illuminated and the last set hold temperature will be displayed.

Press *Hold* key. To change the hold temperature, press the *Up or Down arrow* key.

Press *Retherm* key. Oven preheat indicator will illuminate and the last set retherm temperature is displayed. To change the *Retherm* temperature, press the *Up or Down arrow* key.

## TO RETHERM BY TIME

Press the *Time* key. Last set time is displayed. To change the set time, press the *Up or Down arrow* key. The green *Time* indicator will illuminate.

## TO RETHERM BY PROBE (if oven is equipped with a probe)

Press the *Probe* key. Last set internal product temperature is displayed. To change the set temperature, press the *Up or Down arrow* keys. The green *Probe* indicator will illuminate.

**The oven preheat indicator will illuminate. Oven is now in the preheat mode and is automatically programmed to preheat to the retherm temperature.**

Select a letter code for the product programmed by the previous steps. Press and hold the selected *Preset* key until you hear a brief, four second beep. The letter key program indicator light will illuminate and the product programmed is now stored in memory for the specific letter key pressed. Additional programs can be stored in the remaining *Preset* keys if not previously programmed.

**Note: The last *Preset* key used will be the oven retherm run sequence for the next products to be programmed. Setting can be manually changed for the next product and an alternate pre-programmed letter key selected.**

After programming a specific product into memory for a *Preset* key, it is important to make a written permanent record of the product and the program letter assigned.

## ERASING A RETHERM PROGRAM

To erase a program, the oven must be in either the *power-up* mode or in the *preheat* mode. The oven cannot be running a *Preset Menu* program.

When the oven is in the power-up mode or in the preheat mode, press and hold both the *Cancel* key and the appropriate letter *Preset* key to be erased. The oven will beep in approximately four seconds, and the program’s indicator light will go out to indicate the program has been erased.

# ELECTRONIC CONTROL • OPERATION

## SETTING THE INTERNAL CLOCK:

The control must be in the OFF position to adjust the internal control clock.

### A. TIME - A Preset key

Press and hold the A Preset key. After 4 seconds, the display will indicate the current setting in 24-hour (military time). Press the *Up or Down arrow* keys to adjust.

### B. YEAR - B Preset key

Press and hold the B Preset key. After 4 seconds, the display will show the current set year. Press the *Up or Down arrow* to adjust.

### C. MONTH - C Preset key

Press and hold the C Preset key. After 4 seconds the display will show the current set month. Press the *Up or Down arrow* to adjust.

### D. DATE - D Preset key

Press and hold the D Preset key. After 4 seconds the display will show the current set date. Press the *Up or Down arrow* to adjust.

### E. DAY OF WEEK - E Preset Key

Press and hold the E Preset Key. After 4 seconds the display will show the day of the week. Press the *Up or Down Arrow* key to adjust.

## POWER FAIL DETECT:

In the event of a power failure during an operation mode, the control will retain the programmed operating conditions in memory. When power is restored, the control will resume operating from the point it was interrupted and the *On/ Off* indicator light will flash to indicate a power failure has occurred. To display the amount of time the power was off and to disengage the flashing indicator, press and release the *On/ Off* key.



## CAUTION

IF A POWER FAILURE OCCURS, FOLLOW LOCAL HEALTH (HYGIENE) REGULATIONS TO MAKE CERTAIN THE FOOD PRODUCT IN THE RETHERM OVEN REMAINS SAFE FOR HUMAN CONSUMPTION.

## OPERATIONAL STOP:

Press and hold the *Start* key until an audible signal sounds. The oven will remain in a power-on state but the current operating mode will be cancelled.

## BEEPER VOLUME:

With the control in the OFF position, press and hold the *Down Arrow* key. After 5 seconds the display indicate one of four volume levels from 0 as the lowest volume to 3 as the highest. Release the down arrow after each change to clear the display. Repeat the process to select another volume level.

## FAHRENHEIT OR CELSIUS SELECTION:

With the control in the OFF position, press and hold the *Up Arrow* key. After 4 seconds the display will toggle between Celsius and Fahrenheit. Release the up arrow when the desired selection appears. The display must clear before the process can be repeated.

## PRESET KEYS LOCK & UNLOCK

*Preset* Keys A through H can be locked in order to prevent storing, altering or erasing a program.

To lock the *Preset* keys, press and hold the "I" Key for four seconds. Oven will beep. Release the "I" key. The green indicator on the "I" key will illuminate. Oven *Preset* Keys A through H are now locked.

Note: Only the oven *Preset* Keys A through H are affected by this lock-out in order to also allow the oven to be used with the unprogrammed *Retherm, Probe, or Hold* modes.

To unlock the *Preset* Keys, press and hold the *Cancel* key along with the "I" Key for four seconds. You will hear a brief beep. Release all keys. The green indicator on the "I" key will extinguish. The oven *Preset* keys are now unlocked.

## CONTROL PANEL LOCK & UNLOCK

The control panel can be locked at any time in order to prevent inadvertent or accidental setting changes.

To lock the control panel, press and hold the *Up Arrow* key and then press the *On/ Off* key. You will hear a brief beep and the panel lock indicator will illuminate. Release all keys. The oven's control panel is now locked.

Note: The control panel is now fully locked with the exception of the *On/ Off* key and *Arrow* keys. You will be unable to turn the oven control off at this point.

To unlock the control panel, press and hold the *Down Arrow* key and then press the *On/ Off* key. You will hear two brief beeps and the panel lock indicator will extinguish. Release all keys. The panel is now unlocked and ready for normal use.

# ELECTRONIC CONTROL • OPERATION

## AUDIBLE SIGNALS

OVEN BEEPING is used to indicate a YES or NO response to operator input.

Beeps also indicate mode CHANGES and ERROR conditions.

One brief beep indicates a YES (enabled) response to the information entered into the control.

Two brief beeps indicate a NO (disabled) response to the information entered into the control.

A beep that lasts for one second indicates an oven mode TRANSITION. Example: Preheat to Ready-Start.

Three brief beeps indicate the oven is in the READY mode for product loading and START-UP.

Four brief beeps indicate an existing FAULT condition. Refer to the Trouble Shooting section of this manual.

Beeper volume can be changed. With the control in the Off mode, press and hold the Down Arrow key. After 4 seconds, the display will exhibit one of the 4 volume levels (0 being Off or the lowest, and 3 being the highest). After each change, the button must be released and the display must clear before the procedure can be repeated to select a different volume level.

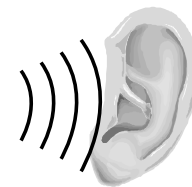

## OPERATING FEATURES & FUNCTIONS

### Turn the Oven Control Panel Off:

Press and hold the *On/ Off* key for three seconds. Oven will beep. The *On/ Off* indicator light will go out.

### Stop an Operation:

Press and hold the *Start* key for several seconds until the control beeps, indicating the operation has been cancelled. The oven will remain in a power-on state.

### Arrow Keys:

*Cook, Hold and Probe* Temperature set points can be adjusted by 1° when pressing the *Arrow* keys. To change a set point more rapidly, press and hold the *Arrow* key along with the key for the temperature function, and the temperature changes in steps of 10°F or 5°C.

The Time setting is adjusted in increments of one minute by pressing the *Arrow* keys. To make adjustment in steps of ten minutes, press and hold the *Time* key and *Arrow* key at the same time.

### Halo Heat Indicator:

When the oven is preheating the *Halo Heat* indicator light will remain illuminated until it reaches the set retherm temperature. Once the temperature has stabilized, this indicator will illuminate periodically as the oven calls for heat.

### Green and Amber Indicators:

Each program key includes a green light which indicates a requirement for additional programming by the operator or the current operational state of the oven.

The *Retherm, Time, Probe, and Hold* keys include an amber indicator light to identify the information being displayed.

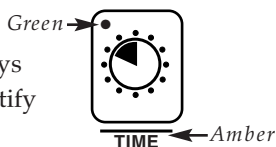

### Display High/Low Probe Temperatures: *(if oven comes equipped with an optional probe)*

To observe the recorded maximum or minimum probe temperature during a cooking program press the following keys:

Highest Temperature: Press *Probe* key and *Up Arrow* key at same time.

Lowest Temperature: Press *Probe* key and *Down Arrow* key at same time.

### Probe Usage: *(if oven comes equipped with an optional probe)*

When the probe is left in the probe bracket, the LED temperature display will indicate the ambient air temperature inside the oven. To use the probe for cooking remove it from the bracket and wipe the full length of the metal probe with a disposable alcohol pad to clean and sanitize before using.

### SPECIAL ATTENTION:

When preheating, the temperature of the product probe reaches the air temperature inside the oven. Always allow the product probe temperature to decrease to the internal temperature of the raw product by inserting the probe and waiting one full minute before pressing the start button. A false reading of the internal temperature of the product may cause the oven to default to a holding temperature.

Only the tip of the probe senses the internal product temperature; therefore, it is important the tip be placed correctly in the product for internal temperature accuracy. Push the probe tip halfway into the product, positioning the tip at the center of the food mass. When inserting the probe into solid foods such as meat roast or poultry breasts, push the probe in from a straight downward position or in from the side to the center position. If placing into a semi-liquid or liquid product, the probe cable must be secured to keep the probe positioned properly. Do not let the probe tip touch the edges, bottom or side of a container. Tape the probe cable to the lip or edge of the container.

# PRODUCT REHEATING GUIDELINES

MENU ITEM	OVEN TEMPERATURE	TIME MINUTES	OVEN VENTS	TRAYS OR PANS			NOTES
				12•20	2800/S	2800	
Beans, Baked	300°F (149°C)	55 to 60	closed	12	8	16	Reheat in 2" deep, full-size, covered steam pans (GN 1/1).
Biscuits, Buttermilk —FROZEN	350°F (177°C)	20	open full	6	8	16	Bake on sheet pans (GN 2/1).
Burritos	300°F (149°C)	50 to 60	open full	6	8	16	Reheat on sheet pans (GN 2/1).
Chicken Breasts, Grilled —FROZEN	300°F (149°C)	90	open half	12	8	16	Reheat on sheet pans (GN 2/1).
Chicken Nuggets	350°F (177°C)	40 to 50	open full	12	8	16	Cook on sheet pans in single layer.
Chicken Patties, Breaded	375°F (190°C)	50 to 60	open full	6	4	8	Reheat on sheet pans (GN 2/1). Limit to pans for maximum browning.
Cookies	350°F (177°C)	20	open full	12	8	16	Bake on evenly spaced sheet pans to produce more even browning.
Corn Dogs	300°F (149°C)	45 to 60	open full	6	4	8	Reheat on sheet pans (GN 2/1).
Entrée, Portioned 6 to 8 oz (170 to 227 gm) —i.e., LASAGNA	320°F (160°C)	60 to 90	closed	208	175	350	Time will depend on the density of the food and the portion size.
Entrée, Pans 5 lb (2,3 kg) —i.e., LASAGNA	325°F (163°C)	70 to 90	closed	24	8	16	Heat on sheet pans or shelves (GN 2/1). Time will depend on the density of the food and the portion size.
Fish Patties, Breaded	300°F (149°C)	60	open half	6	4	8	Bake on sheet pans (GN 2/1).
French Fries	375°F (190°C)	45	open full	6	4	8	Bake on sheet pans (GN 2/1).
Hamburger Patties —PREMARKED & COOKED	300°F (149°C)	60 to 70	closed	12	8	16	Reheat on sheet pans (GN 2/1).
Hot Dogs	300°F (149°C)	40 to 60	closed	12	8	16	Cook on sheet pans (GN 2/1).
Pizza	350°F (177°C)	45	open full	6	4	8	Cook on sheet pans (GN 2/1).
Potatoes, Mashed (BAGS)	300°F (149°C)	70	closed	12	8	16	Reheat bags on sheet pans.
Potatoes, Tater-Tots	375°F (190°C)	90	open full	6	4	8	Bake on sheet pans (GN 2/1). Coat pans with vegetable release spray. Reduce pan capacity for crisper product with more browning.
Rice (PRE-COOKED)	350°F (177°C)	120	closed	12	8	16	Reheat covered in 2" (51mm) steam pans.
Rolls (BROWN & SERVE)	375°F (190°C)	25 to 35	open full	6	4	8	Bake on sheet pans (GN 2/1).
Rolls, Cinnamon	350°F (177°C)	40	open full	6	4	8	Bake on sheet pans (GN 2/1) with parchment paper.
Rolls, Quesadilla	300°F (149°C)	35 to 40	open full	6	4	8	Reheat on sheet pans (GN 2/1).
Sandwiches, BEEF & CHEESE HOT POCKETS	300°F (149°C)	45	open half	6	4	8	Bake on sheet pans (GN 2/1).
Vegetables, Canned	300°F (149°C)	30	closed	12	8	16	Reheat in 2" deep, full-size, uncovered steam pans (GN 1/1).
Vegetables, Frozen	300°F (149°C)	70 to 90	closed	12	8	16	Reheat in 2" deep, full-size, covered steam (GN 1/1).

These product reheating procedures are suggested guidelines only.

# OPERATION

## GENERAL HOLDING GUIDELINES

Chefs, cooks and other specialized food service personnel employ varied methods of cooking. Proper holding temperatures for a specific food product must be based on the moisture content of the product, product density, volume, and proper serving temperatures. Safe holding temperatures must also be correlated with palatability in determining the length of holding time for a specific product.

Halo Heat maintains the maximum amount of product moisture content without the addition of water, water vapor, or steam. Maintaining maximum natural product moisture preserves the natural flavor of the product and provides a more genuine taste. In addition to product moisture retention, the gentle properties of Halo Heat maintain a consistent temperature throughout the cabinet without the necessity of a heat distribution fan, thereby preventing further moisture loss due to evaporation or dehydration.

When product is removed from a high temperature cooking environment for immediate transfer into equipment with the lower temperature required for hot food holding, condensation can form on the outside of the product and on the inside of plastic containers used in self-service applications. Allowing the product to release the initial steam and heat produced by high temperature cooking can alleviate this condition. To preserve the safety and quality of freshly cooked foods, however, a maximum of 1 to 2 minutes must be the only time period allowed for the initial heat to be released from the product.

Use a metal-stemmed thermometer to measure the internal temperature of the product(s) being held. Adjust the thermostat setting to achieve the best overall setting based on internal product temperature.

HOLDING TEMPERATURE RANGE		
MEAT	FAHRENHEIT	CELSIUS
BEEF ROAST — Rare	140°F	60°C
BEEF ROAST — Med/Well Done	160°F	71°C
BEEF BRISKET	160° — 175°F	71° — 79°C
CORN BEEF	160° — 175°F	71° — 79°C
PASTRAMI	160° — 175°F	71° — 79°C
PRIME RIB — Rare	140°F	60°C
STEAKS — Broiled/Fried	140° — 160°F	60° — 71°C
RIBS — Beef or Pork	160°F	71°C
VEAL	160° — 175°F	71° — 79°C
HAM	160° — 175°F	71° — 79°C
PORK	160° — 175°F	71° — 79°C
LAMB	160° — 175°F	71° — 79°C
POULTRY		
CHICKEN — Fried/Baked	160° — 175°F	71° — 79°C
DUCK	160° — 175°F	71° — 79°C
TURKEY	160° — 175°F	71° — 79°C
GENERAL	160° — 175°F	71° — 79°C
FISH/ SEAFOOD		
FISH — Baked/Fried	160° — 175°F	71° — 79°C
LOBSTER	160° — 175°F	71° — 79°C
SHRIMP — Fried	160° — 175°F	71° — 79°C
BAKED GOODS		
BREADS/ROLLS	120° — 140°F	49° — 60°C
MISCELLANEOUS		
CASSEROLES	160° — 175°F	71° — 79°C
DOUGH — Proofing	80° — 100°F	27° — 38°C
EGGS —Fried	150° — 160°F	66° — 71°C
FROZEN ENTREES	160° — 175°F	71° — 79°C
HORS D'OEUVRES	160° — 180°F	71° — 82°C
PASTA	160° — 180°F	71° — 82°C
PIZZA	160° — 180°F	71° — 82°C
POTATOES	180°F	82°C
PLATED MEALS	180°F	82°C
SAUCES	140° — 200°F	60° — 93°C
SOUP	140° — 200°F	60° — 93°C
VEGETABLES	160° — 175°F	71° — 79°C
The holding temperatures listed are suggested guidelines only.		

## CAUTION

**TO MAINTAIN SAFE TEMPERATURE LEVELS, COLD FOOD FOR RETHERMALIZATION OR REHEATING MUST NEVER BE ADDED TO THE OVEN WHILE HOT FOODS ARE BEING HELD.**

# CARE AND CLEANING

## CLEANING AND PREVENTIVE MAINTENANCE

### PROTECTING STAINLESS STEEL SURFACES



It is important to guard against corrosion in the care of stainless steel surfaces. Harsh, corrosive, or inappropriate chemicals can completely destroy the

protective surface layer of stainless steel. Abrasive pads, steel wool, or metal implements will abrade surfaces causing damage to this protective coating and will eventually result in areas of corrosion.

Even water, particularly hard water that contains high to moderate concentrations of chloride, will cause oxidation and pitting that result in rust and corrosion. In addition, many acidic foods spilled and left to remain on metal surfaces are contributing factors that will corrode surfaces.

Proper cleaning agents, materials, and methods are vital to maintaining the appearance and life of this appliance. Spilled foods should be removed and the area wiped as soon as possible but at the very least, a minimum of once a day. Always thoroughly rinse surfaces after using a cleaning agent and wipe standing water as quickly as possible after rinsing.

### CLEANING AGENTS

Use non-abrasive cleaning products designed for use on stainless steel surfaces. Cleaning agents must be chloride-free compounds and must not contain quaternary salts. Never use hydrochloric acid (muriatic acid) on stainless steel surfaces. Always use the proper cleaning agent at the manufacturer's recommended strength. Contact your local cleaning supplier for product recommendations.

### CLEANING MATERIALS

The cleaning function can usually be accomplished with the proper cleaning agent and a soft, clean cloth. When more aggressive methods must be employed, use a non-abrasive scouring pad on difficult areas and make certain to scrub with the visible grain of surface metal to avoid surface scratches. Never use wire brushes, metal scouring pads, or scrapers to remove food residue.

	<p><b>CAUTION</b></p> <p><b>TO PROTECT STAINLESS STEEL SURFACES, COMPLETELY AVOID THE USE OF ABRASIVE CLEANING COMPOUNDS, CHLORIDE BASED CLEANERS, OR CLEANERS CONTAINING QUATERNARY SALTS. NEVER USE HYDROCHLORIC ACID (MURIATIC ACID) ON STAINLESS STEEL. NEVER USE WIRE BRUSHES, METAL SCOURING PADS OR SCRAPERS.</b></p>
--	--

# CARE AND CLEANING



Under normal operating conditions, this oven will provide you with long and trouble-free service. There is no preventative maintenance required, however, the following guidelines will maximize the potential life and trouble-free operation of this oven.

## CLEAN THE OVEN DAILY

Cleanliness and appearance of this equipment will contribute considerably to operating efficiency and savory, appetizing food. Good equipment that is kept clean works better and lasts longer.

1. Turn oven power switch to the "OFF" position. Allow the oven to cool.
2. Remove all detachable items such as roll-in cart and shelves. Clean these items separately.
3. Wipe the interior metal surfaces of the oven with a paper towel to remove loose food debris.
4. Clean interior with a damp cloth or sponge and any good commercial detergent at the recommended strength.
5. Spray heavily soiled areas with a water soluble degreaser and let stand for 10 minutes. Remove soil with a plastic scouring pad.

**NOTE:** Avoid the use of abrasive cleaning compounds, chloride based cleaners, or cleaners containing quaternary salts. Never use hydrochloric acid (muriatic acid) on stainless steel.



6. Wipe the control panel, door vents, and door handles thoroughly since these areas harbor food debris.
7. Rinse surfaces by wiping with sponge and clean warm water.
8. Remove excess water with sponge and wipe dry with a clean cloth or air dry. Leave doors open until interior is completely dry. Replace side racks and shelves.
9. Dry the control panel with a clean, soft cloth.
10. The interior can be wiped with a sanitizing solution after cleaning and rinsing. This solution must be approved for use on stainless steel food contact surfaces.
11. To help maintain the protective film coating on polished stainless steel, clean the exterior of the cabinet with a cleaner recommended for stainless steel surfaces. Spray the cleaning agent on the cloth and wipe with the grain of the stainless steel.

Always follow appropriate state or local health (hygiene) regulations regarding all applicable cleaning and sanitation requirements for equipment.



# CARE AND CLEANING

## ROLL-IN CART/FOOD TROLLEY

### CLEANING (ON EQUIPPED MODELS)

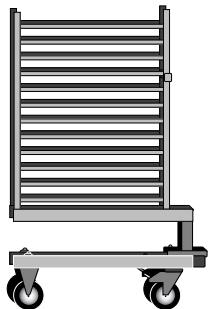

1. Remove food trolley to a cart wash area. Trolleys may be cleaned using any mild cleaning detergent and warm water.
2. Hand wipe all framing, slides, drip pan, and base. Thoroughly clean debris from the casters. A spray hose can be used for easier cart cleaning.
3. Remove detergent solution with warm water.
4. Wipe or spray with a sanitizing solution designed for use on metal and vinyl food contact surfaces.
5. Allow trolley to air dry.

### DAILY GASKET CLEANING

It is important to prolong the life of the oven gasket by cleaning this item on a daily basis. Routine cleaning will help protect the composition of the gasket from deterioration caused by acidic foods. After allowing the oven to cool, remove pull-out gasket and wash in hot, soapy water.

*Do not* place in dishwasher.

**Always replace the gasket before cleaning the oven interior or operating the oven.**



# SANITATION

Food flavor and aroma are usually so closely related that it is difficult, if not impossible, to separate them. There is also an important, inseparable relationship between cleanliness and food flavor. Cleanliness, top operating efficiency, and appearance of equipment contribute considerably to savory, appetizing foods. Good equipment that is kept clean, works better and lasts longer.

Most food imparts its own particular aroma and many foods also absorb existing odors. Unfortunately, during this absorption, there is no distinction between GOOD and BAD odors. The majority of objectionable flavors and odors troubling food service operations are caused by bacteria growth. Sourness, rancidity, mustiness, stale or other OFF flavors are usually the result of germ activity.

The easiest way to insure full, natural food flavor is through comprehensive cleanliness. This means good control of both visible soil (dirt) and invisible soil (germs). A thorough approach to sanitation will provide essential cleanliness. It will assure an attractive appearance of equipment, along with maximum efficiency and utility. More importantly, a good sanitation program provides one of the key elements in the prevention of food-borne illnesses.

A controlled holding environment for prepared foods is just one of the important factors involved in the prevention of food-borne illnesses. Temperature monitoring and control during receiving, storage, preparation, and the service of foods are of equal importance.

The most accurate method of measuring safe temperatures of both hot and cold foods is by internal product temperature. A quality thermometer is an effective tool for this purpose, and should be routinely used on all products that require holding at a specific temperature.

A comprehensive sanitation program should focus on the training of staff in basic sanitation procedures. This includes personal hygiene, proper handling of raw foods, cooking to a safe internal product temperature, and the routine monitoring of internal temperatures from receiving through service.

Most food-borne illnesses can be prevented through proper temperature control and a comprehensive program of sanitation. Both these factors are important to build quality service as the foundation of customer satisfaction. Safe food handling practices to prevent food-borne illness is of critical importance to the health and safety of your customers. HACCP, an acronym for Hazard Analysis (at) Critical Control Points, is a quality control program of operating procedures to assure food integrity, quality, and safety. Taking steps necessary to augment food safety practices are both cost effective and relatively simple. While HACCP guidelines go far beyond the scope of this manual, additional information is available by contacting:

**Center for Food Safety and Applied Nutrition  
Food and Drug Administration  
1-888-SAFEFOOD**

INTERNAL FOOD PRODUCT TEMPERATURES		
<b>HOT FOODS</b>		
DANGER ZONE	40° TO 140°F	(4° TO 60°C)
CRITICAL ZONE	70° TO 120°F	(21° TO 49°C)
SAFE ZONE	140° TO 165°F	(60° TO 74°C)
<b>COLD FOODS</b>		
DANGER ZONE	ABOVE 40°F	(ABOVE 4°C)
SAFE ZONE	36°F TO 40°F	(2°C TO 4°C)
<b>FROZEN FOODS</b>		
DANGER ZONE	ABOVE 32°F	(ABOVE 0°C)
CRITICAL ZONE	0° TO 32°F	(-18° TO 0°C)
SAFE ZONE	0°F OR BELOW	(-18°C OR BELOW)

## SERVICE PARTS LIST

PART DESCRIPTION	MANUAL CONTROL			ELECTRONIC CONTROL		
	12•20RTM	2800/S-RTM	2800-RTM	12•20RTM/e	2800/S-RTM/e	2800-RTM/e
BAFFLE ASSEMBLY	5000486	5000943	5000515	5000486	5000943	5000515
BOARD, VOLTAGE MONITOR	BA-33879	—	—	BA-33879	BA-33764	BA-33764
BUMPER, BACK	12227	—	—	12227	—	—
BUMPER, SIDE	13730	—	—	13730	—	—
CART ASSEMBLY, ROLL-IN (TROLLEY)	5000723	—	—	5000723	—	—
CART GUIDE BLOCK	BK-22100	—	—	BK-22100	—	—
CART HANDLE (TROLLEY)	HD-25590	—	—	HD-25590	—	—
CART SHELF (TROLLEY)	SH-22473	—	—	SH-22473	—	—
CART SHELF LOCK (TROLLEY)	LK-22555	—	—	LK-22555	—	—
CASING, BACK	5000828	1001608	1000986	5000356	1001608	1000986
CASING, BOTTOM	13703	5000445	5000445	13703	5000445	5000445
CASING, LEFT-HAND SIDE	1000640	1001142	1000987	1000640	1001142	1000987
CASING, RIGHT-HAND SIDE	1000639	1001143	1000988	1000639	1001143	1000988
CASING TOP	5000271	5000573	5000573	5000271	5000573	1000985
CASTERS, RIGID, 5" (127mm) CART	CS-23126	—	—	CS-23126	—	—
CASTERS, SWIVEL, 5" (127mm) CART	CS-23127	—	—	CS-23127	—	—
CASTERS, RIGID, 5" (127mm)	CS-22098	—	CS-2025	CS-22098	—	CS-2025
CASTERS, SWIVEL, 5" (127mm)	CS-22099	—	CS-2026	CS-22099	—	CS-2026
CIRCUIT BREAKER, 3PH	CI-33772	—	—	CI-33772	—	—
CIRCUIT BREAKER GUARD	16072	—	—	16072	—	—
CIRCUIT BREAKER SWITCH, 30A	SW-3715	—	—	SW-3715	—	—
CONTACTOR, 25A	CN-3052	CN-3052	CN-3052	CN-3052	CN-3052	CN-3052
AUXILIARY SWITCH 40A	CN-3654	CN-3654	CSN-33927	CN-3654	CN-3654	CN-33927
CONTROL BEEPER	—	—	—	BP-3567	BP-3567	BP-3567
CONTROL, ELECTRONIC	—	—	—	CC-33714	CC-34063	CC-34063
CONTROL PANEL	1000655	1000978	1000978	—	—	1001112

## SERVICE PARTS LIST

PART DESCRIPTION	MANUAL CONTROL			ELECTRONIC CONTROL		
	12•20RTM	2800/S-RTM	2800-RTM	12•20RTM/e	2800/S-RTM/e	2800-RTM/e
CONTROL PANEL OVERLAY	PE-25450	PE-25554	PE-25554	PE-25450	PE-25555	PE-25555
CORD, 6-3, 208-240V- 1 PH	—	—	CD-33847	—	—	CD-33847
CORD, 10-4, 208V, 3PH	—	—	CD-3557	—	—	—
CORD 8-3, 10-FOOT (305cm)	CD-33841	—	—	—	—	—
CORD 10-3, 9-FOOT (274cm)	—	CD-3304	—	—	CD-3304	—
CORD 14/3, 20' (610cm)	—	—	—	CD-3545	—	—
CORD 14/5, 20' (610cm)	—	—	—	CD-3727	—	—
CORD HOOK, COILED	16320	—	—	16320	—	—
DOOR ASSEMBLY	5000530	5000514	5000514	5000530	5000514	5000514
DRIP PAN	11747	—	—	11747	—	—
FAN, CONTROL, COOLING	FA-3974	FA-3974	FA-3974	FA-3974	FA-3974	FA-3974
FAN GUARD	GD-2396	GD-2396	GD-2396	GD-2396	GD-2396	GD-2396
FAN MOTOR	FA-33221	FA-33221	FA-33221	FA-33221	FA-33221	FA-33221
FAN MOTOR COVER	1000648	1000648	1000648	1000648	1000648	1000648
FAN WHEEL	E3045FA	E3045FA	E3045FA	E3045FA	E3045FA	E3045FA
GASKET, BOTTOM	GS-22576	—	—	GS-22576	—	—
GASKET, DOOR	GS-25461	GS-25593	GS-25593	GS-25461	GS-25593	GS-25593
GAUGE, TEMPERATURE	GU-33384	GU-33384	GU-33384			
GUIDE BLOCK, LEFT-HAND	BK-22044	—	—	BK-22044	—	—
GUIDE BLOCK, RIGHT-HAND	BK-22045	—	—	BK-22045	—	—
GUIDE BLOCK, TEFLON	BK-24077	—	—	BK-24077	—	—
HANDLE, CABINET - PULL	HD-22257	—	HD-22257	HD-22257	—	HD-22257
HANDLE, DOOR	HD-2007	HD-2007	HD-2007	HD-2007	HD-2007	HD-2007
HEATING CABLE	CB-3045	CB-3045	CB-3045	CB-3045	CB-3045	CB-3045
HINGE	HG-22338	HG-22338	HG-22338	HG-22338	HG-22338	HG-22338
INDICATOR LIGHT, RED (ROUND)	LI-3025	LI-3025	LI-3025	—	—	—
INDICATOR LIGHT (220,230V)	LI-3951	LI-3951	LI-3951	—	—	—

## SERVICE PARTS LIST

PART DESCRIPTION	MANUAL CONTROL			ELECTRONIC CONTROL		
	12•20RTM	2800/S-RTM	2800-RTM	12•20RTM/e	2800/S-RTM/e	2800-RTM/e
POWER SUPPLY BOARD	BA-33554	BA-33554	—	BA-33554	BA-33554	BA-33554
RELAY, SOLID STATE, 25A 230V	RL-3583	RL-3583	—	RL-3583	— RL-33829	— RL-33829
SENSOR	—	—	—	SN-33541	SN-33541	SN-33541
SENSOR GUARD	1496	—	—	—	—	—
SENSOR MOUNTING BLOCK	—	—	—	BK-24427	—	BK-24427
SURGE PROTECTOR RESISTOR MOV 230V	—	—	—	RS-3578	— RS-3578	RS-3578 RS-3578
SWITCH, POWER ROCKER	SW-3936	SW-3936	SW-3936	—	—	—
TERMINAL BLOCK, FAN 3 FORM	BK-3019	BK-3019	BK-3019	BK-3019	BK-3019	BK-3019
TERMINAL BLOCK, POWER 4 FORM	BK-3597	BK-3597	BK-3597	BK-3597	BK-3597	BK-3597
TERMINAL BLOCK, PORCELAIN	BK-33546	BK-33546	BK-33546	BK-33546	BK-33546	BK-33546
TERMINAL CONNECTOR	CR-3596	CR-3596	CR-3596	CR-3596	CR-3596	CR-3596
TERMINAL CONNECTOR DUAL SPADE	CR-3489	CR-3849	CR-3849	CR-3489	CR-3849	CR-3849
TERMINAL, 5 CIRCUIT STRIP	—	—	—	TM-33560	TM-33560	TM-33560
THERMOSTAT CAP BLOCK	—	BK-24878	BK-24878	—	—	—
THERMOSTAT CAP BLOCK, TEFLON	BK-33844	—	—	—	—	—
THERMOSTAT, HOLDING	TT-33843	TT-33843	TT-33843	—	—	—
THERMOSTAT KNOB, HOLDING	KN-26244	KN-26244	KN-26244	—	—	—
THERMOSTAT, RETHERM SNAP ACTION	TT-33843	TT-33843	TT-33843	—	—	—
THERMOSTAT KNOB, 400° F/250° C	KN-33845	KN-33845	KN-33845	—	—	—
THERMOSTAT, OVER TEMP	TT-3570	TT-3570	TT-3570	TT-3750	TT-3750	TT-3750
TIMER, 4 HR (60 Hz)	TR-26179	TR-26179	TR-26179	—	—	—
TIMER, 4 HR (220-230V, 50 Hz)	TR-26180	TR-26180	TR-26180	—	—	—
— TIMER KNOB	KN-33875	KN-33875	KN-33875	—	—	—

# SERVICE VIEW

## 2800-RTM with Manual Control



# SERVICE VIEW

## 2800/s-RTM with Manual Control

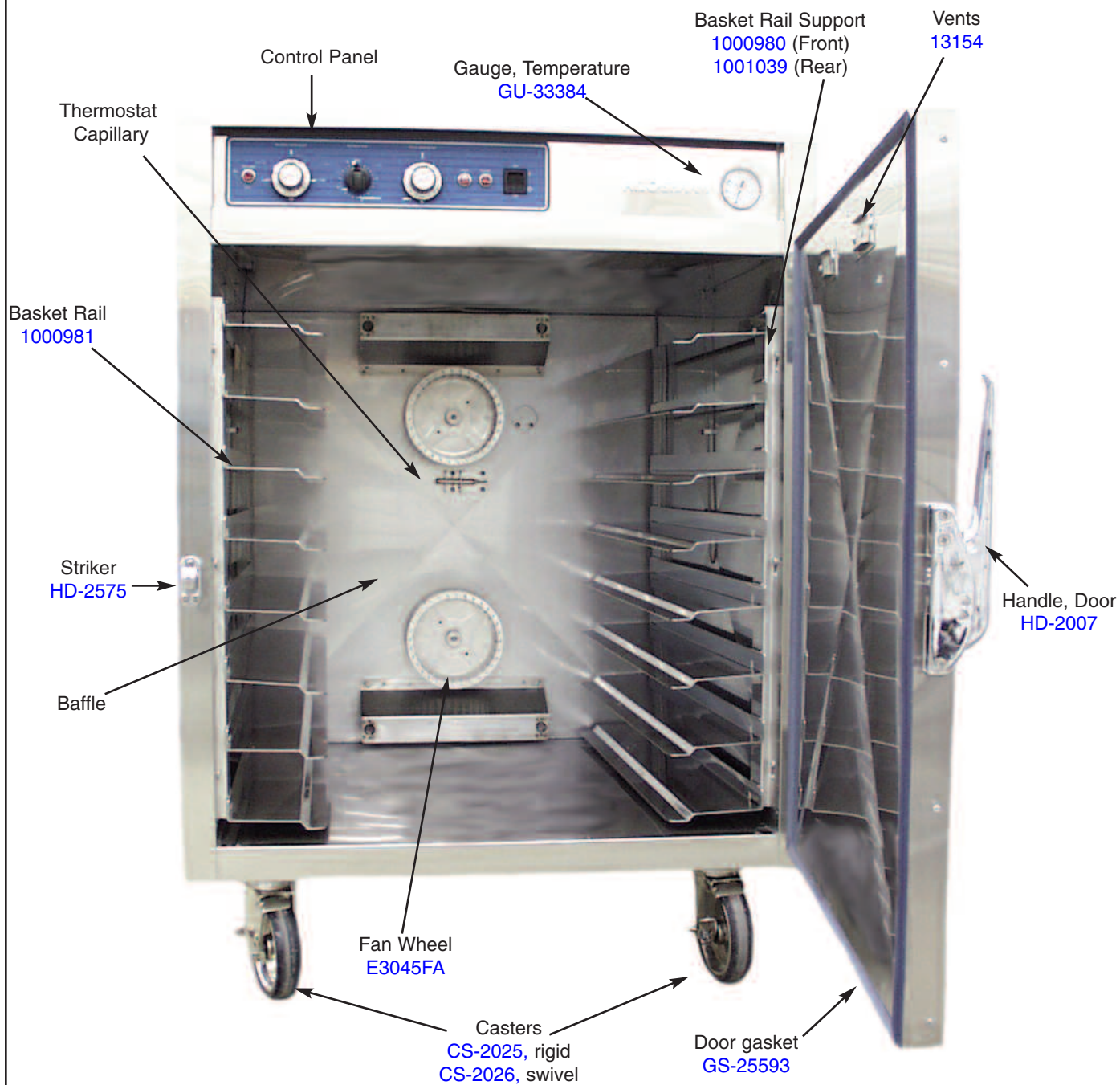

# SERVICE VIEW

## 2800/s-RTM Manual Control Service View

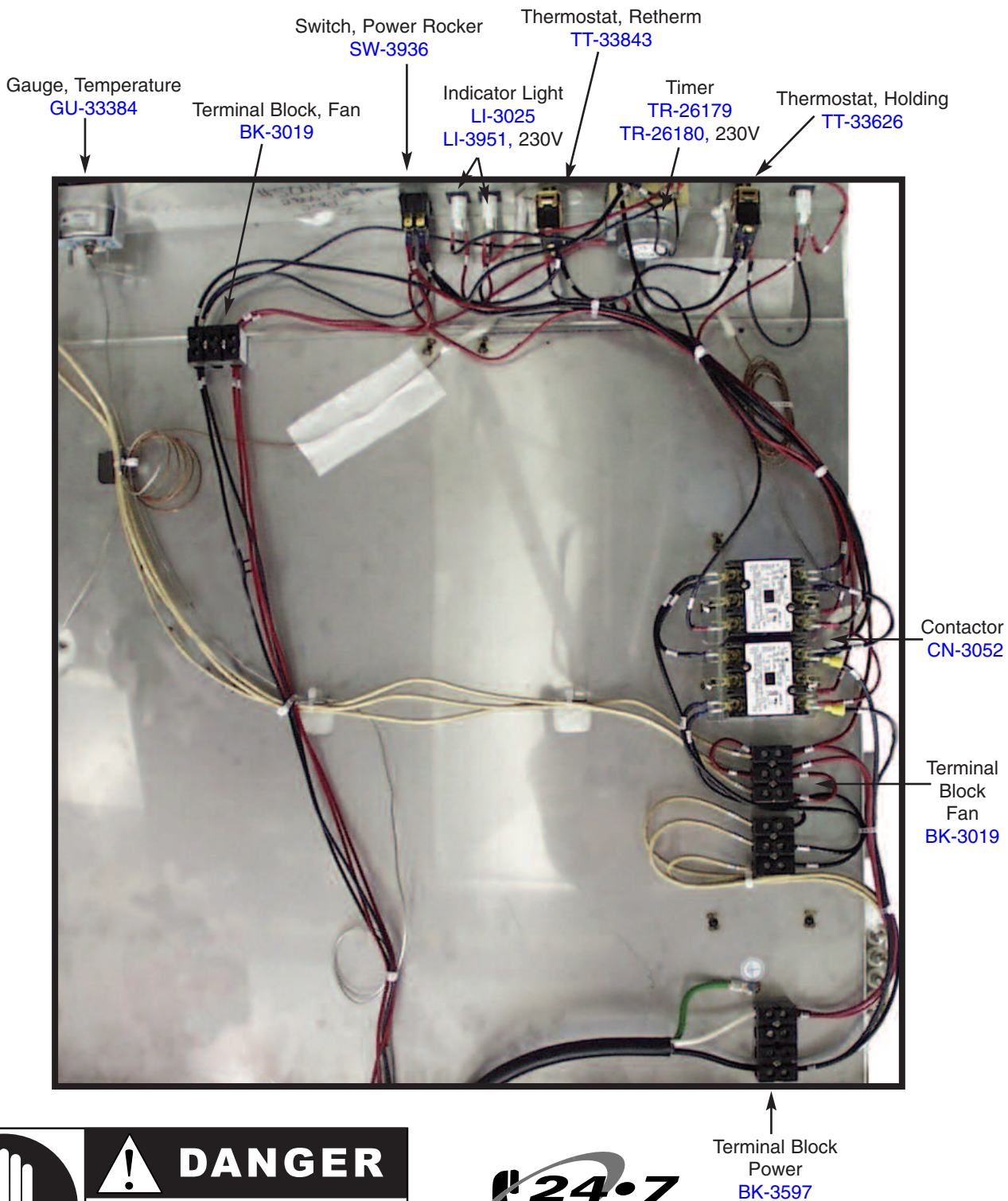

**! DANGER**  
DISCONNECT UNIT FROM  
POWER SOURCE BEFORE  
CLEANING OR SERVICING.



# SERVICE VIEW

## 2800-RTM Manual Control Service View

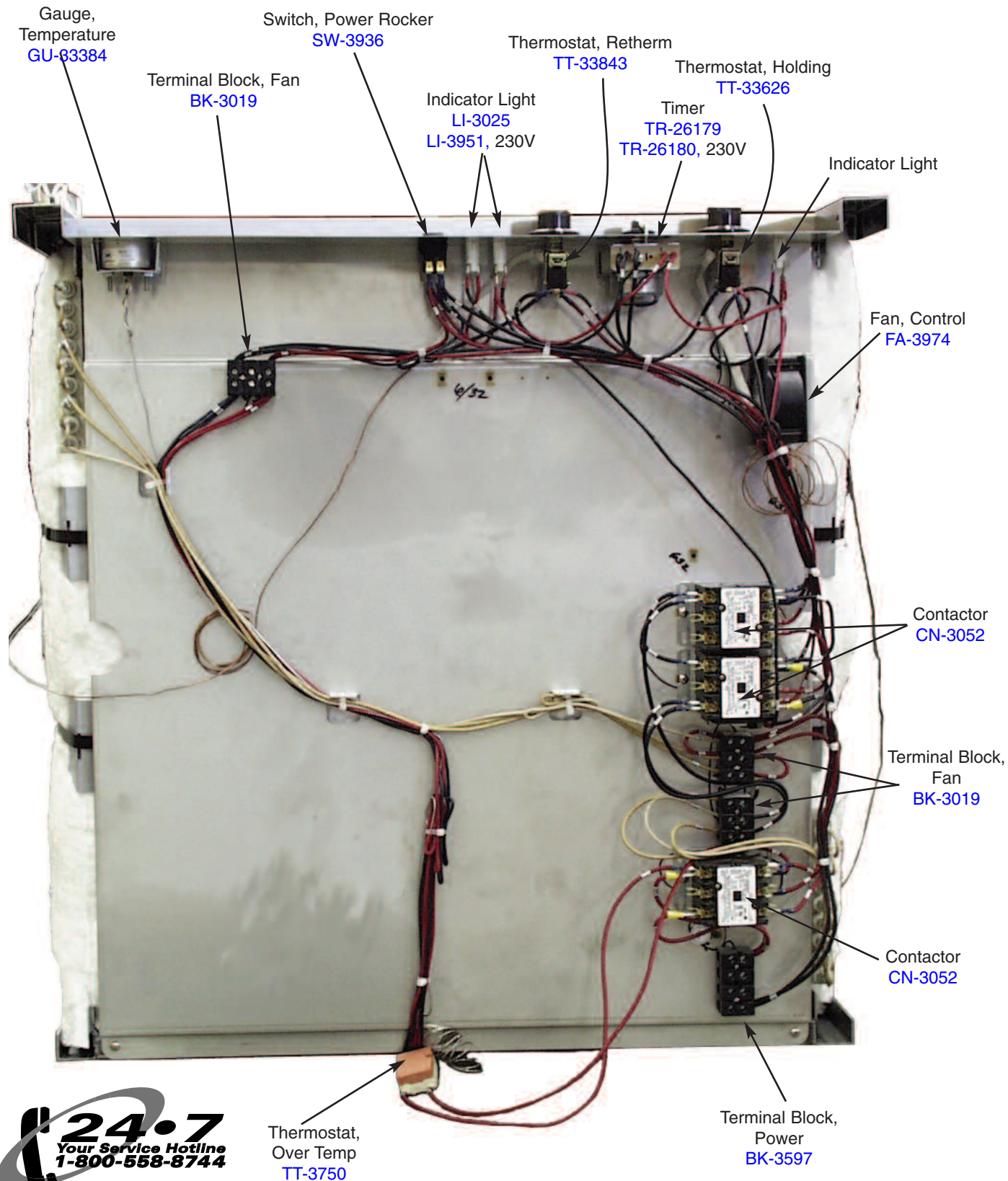

# SERVICE VIEW

## Model 2800-RTM/e Electronic Control

Front of Cabinet

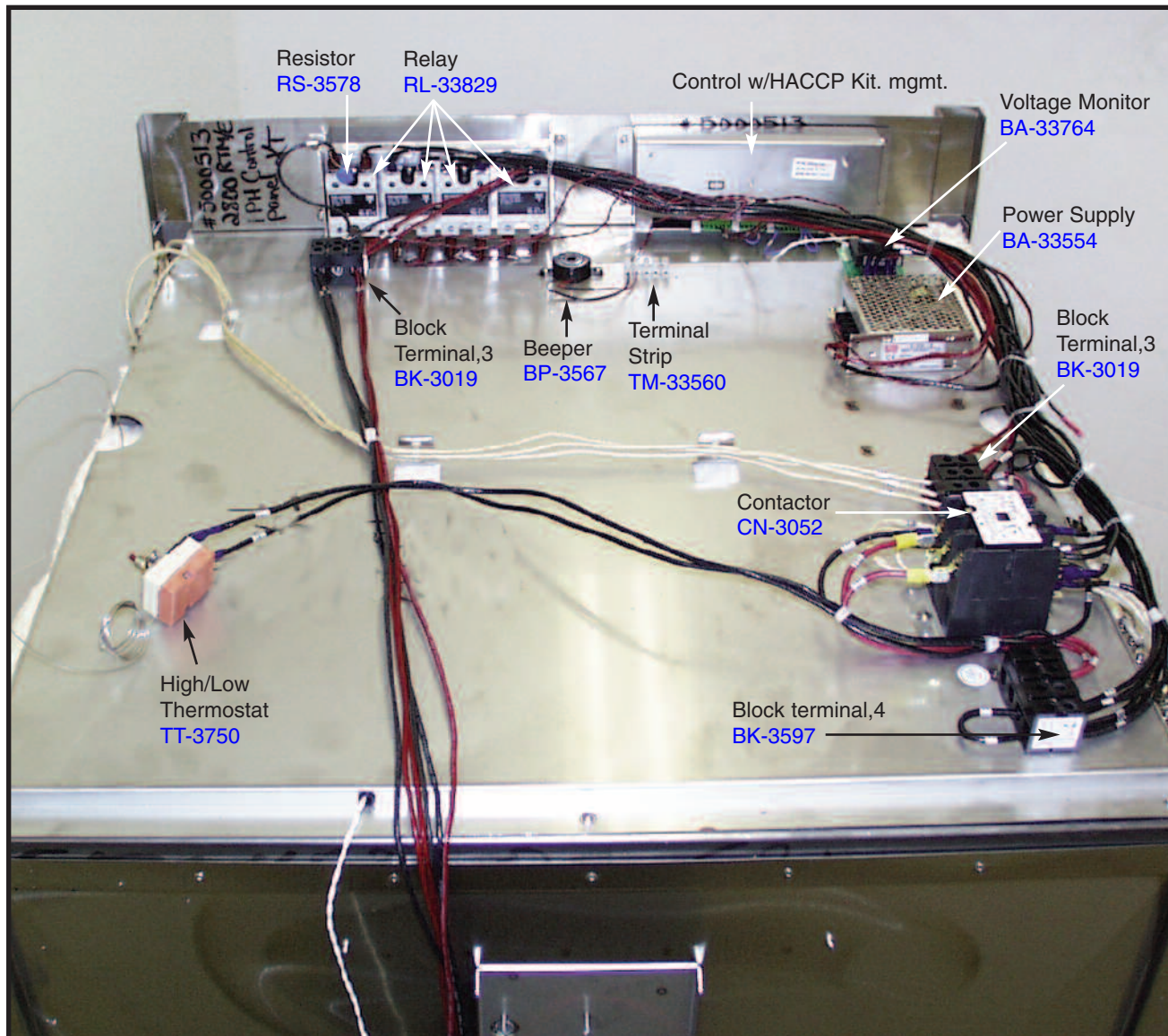

Rear of Cabinet



**DANGER**

DISCONNECT UNIT FROM  
POWER SOURCE BEFORE  
CLEANING OR SERVICING.

# SERVICE VIEW

## Model 12•20-RTM/e Electronic Control with roll-in cart

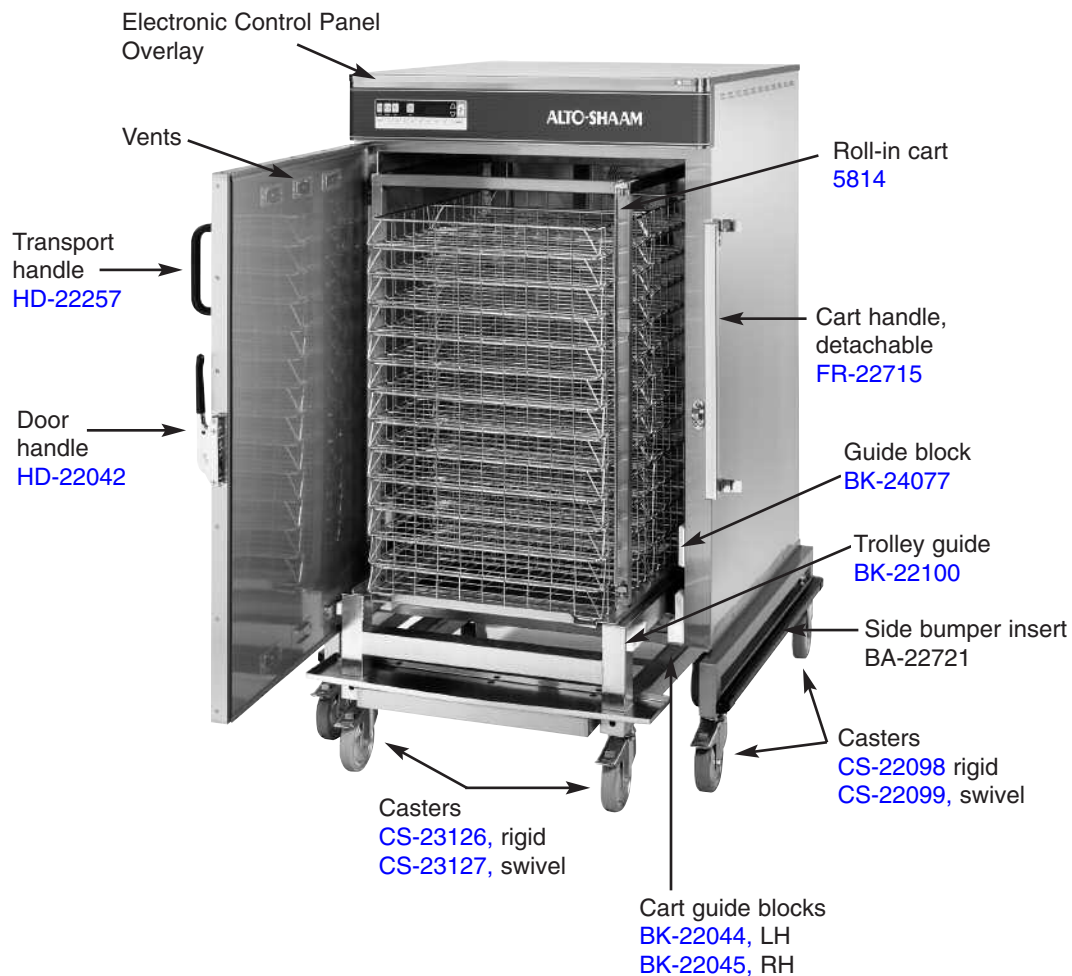

### Preheat Sealing Strip Option



#1000664

# SERVICE

## Cable Replacement Kits

### Model 2800-S/ RTM SERIES

REQUIRES

One (1) No. [14228](#)

One (1) No. [4878](#)

### Model 2800-RTM SERIES

REQUIRES

Two (2) No. [14228](#)

One (1) No. [4878](#)

### Model 12•20-RTM SERIES

REQUIRES

One (1) No. [14228](#)

One (1) No. [4880](#)



#### Cable Replacement Kit No. [4880](#)

includes:

<a href="#">CB-3045</a>	Cable Heating Element	134 feet
<a href="#">CR-3226</a>	Ring Connector	4
<a href="#">IN-3488</a>	Insulation Corner	1 foot
<a href="#">BU-3105</a>	Shoulder Bushing	4
<a href="#">BU-3106</a>	Cup Bushing	4
<a href="#">ST-2439</a>	Stud	4
<a href="#">NU-2215</a>	Hex Nut	8
<a href="#">SL-3063</a>	Insulating Sleeve	4
<a href="#">TA-3540</a>	Electrical Tape	1 roll

#### Cable Replacement Kit No. [4878](#)

includes:

<a href="#">CB-3045</a>	Cable Heating Element	85 feet
<a href="#">CR-3226</a>	Ring Connector	4
<a href="#">IN-3488</a>	Insulation Corner	1 foot
<a href="#">BU-3105</a>	Shoulder Bushing	4
<a href="#">BU-3106</a>	Cup Bushing	4
<a href="#">ST-2439</a>	Stud	4
<a href="#">NU-2215</a>	Hex Nut	8
<a href="#">SL-3063</a>	Insulating Sleeve	4
<a href="#">TA-3540</a>	Electrical Tape	1 roll

#### Cable Replacement Kit No. [14228](#)

includes:

<a href="#">CB-3045</a>	Cable Heating Element	280 feet
<a href="#">CR-3226</a>	Ring Connector	16
<a href="#">IN-3488</a>	Insulation Corner	1 foot
<a href="#">BU-3105</a>	Shoulder Bushing	16
<a href="#">BU-3106</a>	Cup Bushing	16
<a href="#">ST-2439</a>	Stud	16
<a href="#">NU-2215</a>	Hex Nut	32
<a href="#">SL-3063</a>	Insulating Sleeve	16
<a href="#">TA-3540</a>	Electrical Tape	1 roll

# SERVICE

## TROUBLESHOOTING FOR ELECTRONIC CONTROL MODELS

Error Code	Description/Results	Possible Cause Service Required
E-10	<b>Air Sensor Fault (shorted)</b> <i>Inoperative Oven</i>	Air sensor is shorted. Air sensor defective? See following page for air sensor test.
E-11	<b>Air Sensor Fault (open)</b> <i>Inoperative Oven</i>	Air sensor is open or connection failure. Air sensor defective? See following page for air sensor test.
E-20	<b>Product Probe Fault (shorted)</b> <i>Oven will cook in time only</i>	Product probe is shorted Probe defective? See following page for probe sensor test.
E-21	<b>Product Probe Fault (open)</b> <i>Oven will cook in time only</i>	Product Probe is open or connection failure. Probe defective? See following page for probe sensor test.
E-30	<b>Under temperature</b>  <i>Oven will not reach set temperature</i>	Oven door closed? Door gasket need replacement? Preheat skipped? Oven overloaded or has frozen product? Defective air sensor or probe? Defective solid state relay? Bad wire connections or open heating cable? Is the high limit switch tripped? If none of the above, call service.
E-31	<b>Over temperature</b> <i>Oven will shut down</i>	Shorted cable? Defective solid state relay? Defective air sensor? If none of the above, call service.
E-60	<b>Real time clock error</b> <i>Inoperative Oven</i>	Control must be replaced. This error also is displayed if the unit has been unplugged for more than 30 days. If this is the case the unit should be plugged in with the circuit breaker on and the unit displaying the E-60 on the front panel for more than 30 minutes. Once this has been accomplished the circuit breaker should be turned to off or the unit unplugged for about 10 seconds after which the unit should be turned on again. This may have to be repeated.
E-70	<b>Configuration connector error</b> <i>Inoperative Oven</i>	Check control connections for loose wires. If none, control must be replaced.
E-78	<b>Voltage low</b> <i>Inoperative Oven</i>	If 125 VAC unit, voltage is below 90 VAC. Correct. If 208-240 VAC voltage is below 190 VAC. Correct.
E-79	<b>Voltage high</b> <i>Inoperative Oven</i>	If 125 VAC unit, voltage is over 130 VAC. Correct. If 208-240 VAC, voltage is over 250 VAC. Correct.
E-80	<b>EEPROM - Function data error</b> <i>Inoperative Oven</i>	Replace control.
E-82	<b>EEPROM - Calibration data error</b> <i>Inoperative Oven</i>	Replace control.
E-84	<b>EEPROM - Unit ID error</b> <i>Inoperative Oven</i>	Replace control.
E-86	<b>EEPROM - Preset data error</b> <i>Inoperative Oven</i>	Replace control.

### CAUTION

THIS SECTION IS PROVIDED FOR THE ASSISTANCE OF QUALIFIED SERVICE TECHNICIANS ONLY AND IS NOT INTENDED FOR USE BY UNTRAINED OR UNAUTHORIZED SERVICE PERSONNEL.



### DANGER

DISCONNECT UNIT FROM POWER SOURCE BEFORE CLEANING OR SERVICING.

# SERVICE

## TROUBLE SHOOTING INTERNAL ELECTRICAL COMPONENTS

Make sure the proper electrical cord is connected to the appropriate power source.

**NOTE:** 380V 3 phase units are furnished with two cords.

*Never plug in both cords at the same time. Electrical damage may occur.*

### A. No power. Display will not light.

1. Verify that power is available at the outlet or junction box.
2. Verify that the circuit breaker switch on the back of the unit is turned on.
3. Verify that the power cord is not open. Check continuity with a VOM meter.
4. If none of the above steps help, call a qualified service technician or refer to the Service Manual for this particular oven.

### B. Display is lit and unit calls for heat, but unit is not heating; Error Code E30

1. Check to verify that the high limit switch located at the rear of the unit top has not been tripped. If it has been tripped, reset by pressing in the hit limit reset button at the rear of the oven.



After resetting, the cause of the high limit trip must be corrected. If the high limit switch will not reset, the high limit switch is defective and must be replaced. *This is a safety device and must not be jumped out or removed from the circuit.*

### C. To test air sensor:

Test air sensor by placing sensor in ice water bath and using an ohmmeter set on the ohm scale. The reading should be 100 ohms resistance. If it is more than 2 ohms higher or lower, sensor needs to be replaced.

### D. To test probe sensor:

Test food probe by placing in ice water bath and using an ohmmeter set on the ohm scale. The reading should be 100 ohms resistance.

*This section is provided for the assistance of qualified technicians only and is not intended for use by untrained or unauthorized service personnel. If your Alto-Shaam® unit is not operating properly, check the following before calling your Authorized Alto-Shaam® Service Agent:*

- Check the power flow to the unit. Plug in outlet? Circuit breaker switch at back of unit turned on?  
*Do not attempt to repair or service the Cook and Hold unit beyond this point. Contact Alto-Shaam® for the nearest authorized service agent. Repairs made by any other service agents without prior authorization by Alto-Shaam® will void the warranty on the unit.*

## NOTE

If the appliance has been unplugged for an extended period of time, the Real Time Clock may require recharging. Plug the unit into the proper receptacle for a minimum of 24 hours.

## CAUTION

THIS SECTION IS PROVIDED FOR THE ASSISTANCE OF QUALIFIED SERVICE TECHNICIANS ONLY AND IS NOT INTENDED FOR USE BY UNTRAINED OR UNAUTHORIZED SERVICE PERSONNEL.

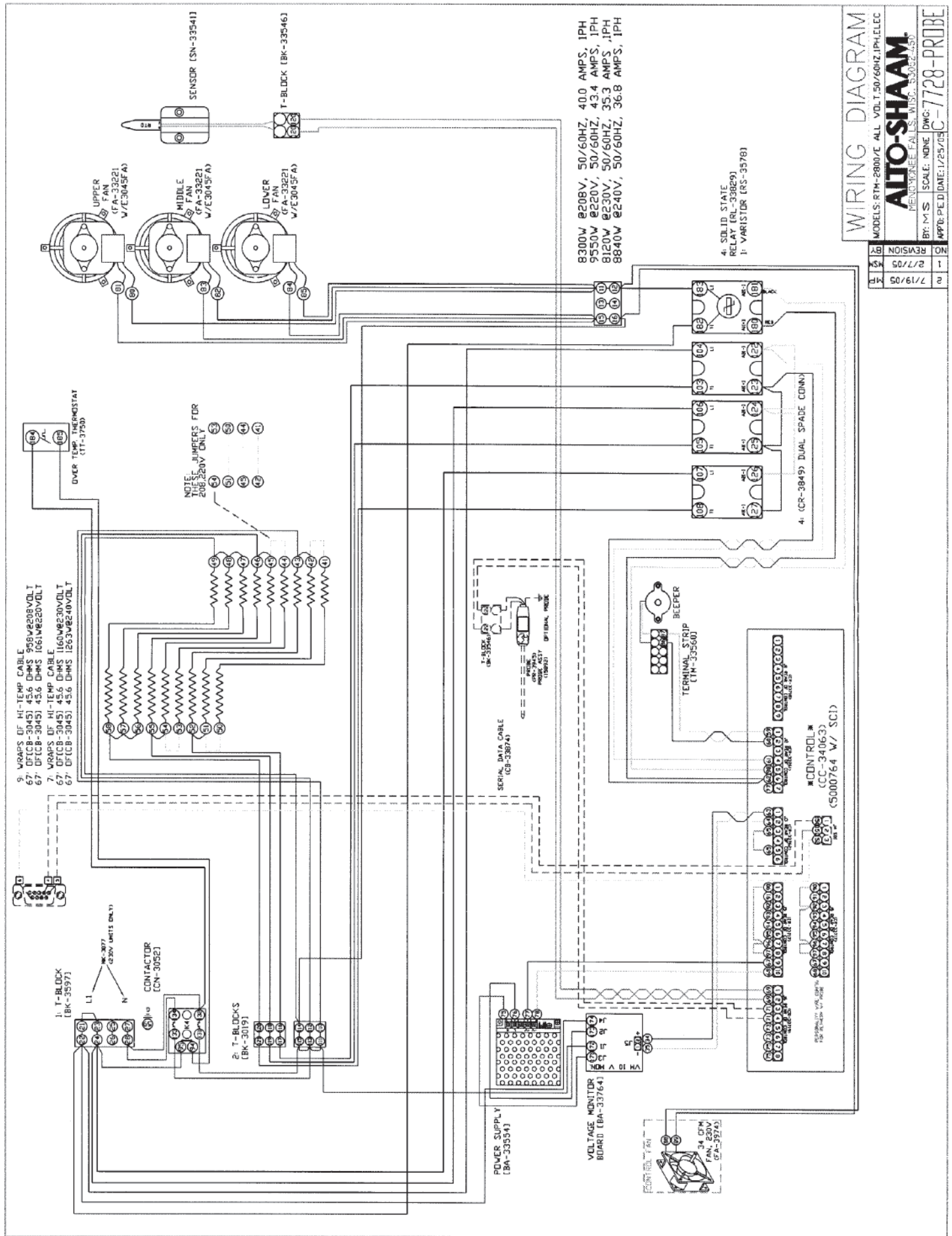

**WIRING DIAGRAM**

MODELS: RTH-2800/C ALL VOLT, 50/60HZ, 1PH, 1ELEC

**ALTO-SHAAM**  
 MENDOTA, ILL. U.S.A. MISC. 30082-50

BY: M.S. SCALE: NONE DWG: 7728-PROBE  
 APPR: P.E. DATE: 1/25/05

NO.	REVISION
1	2/7/05
2	7/19/05

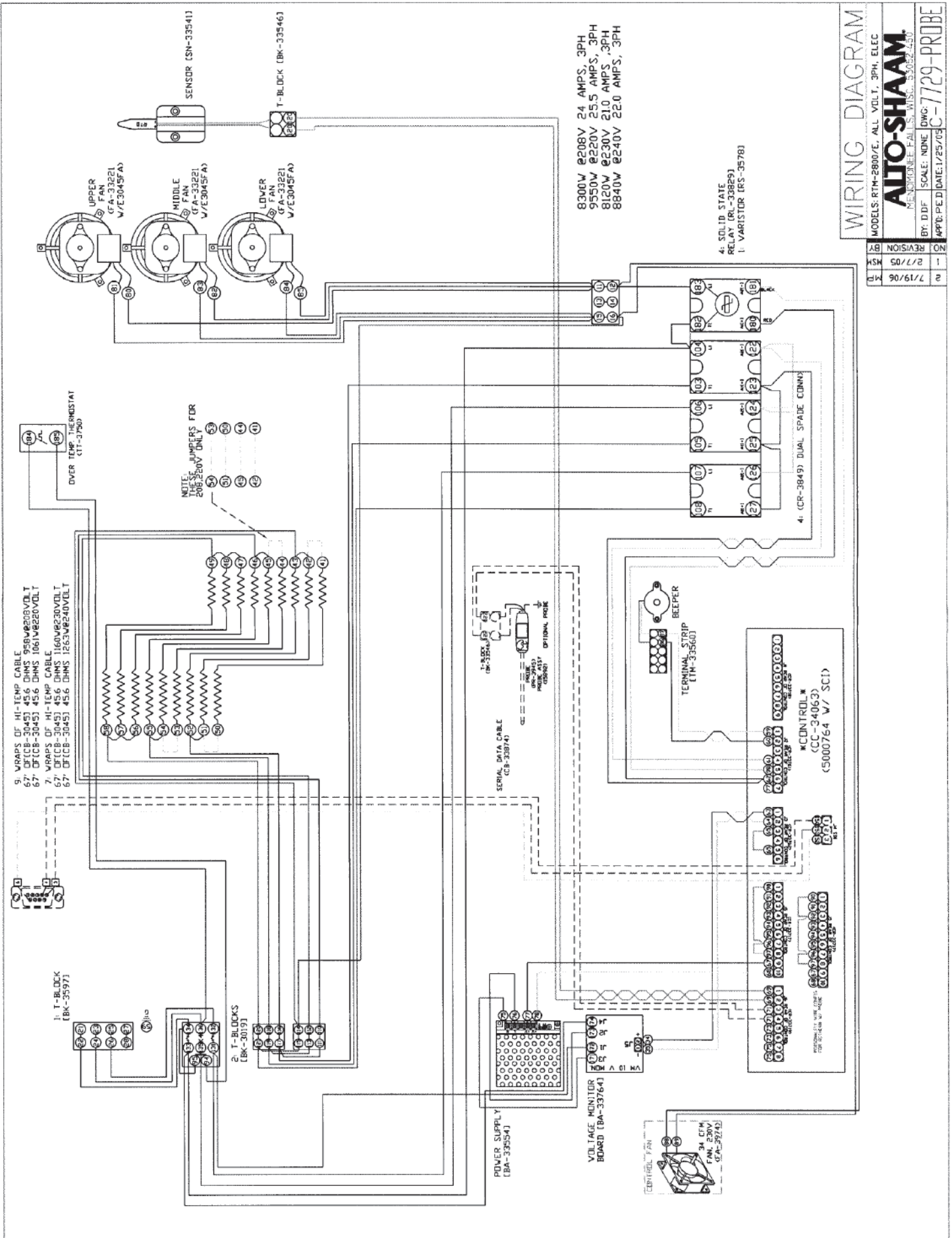



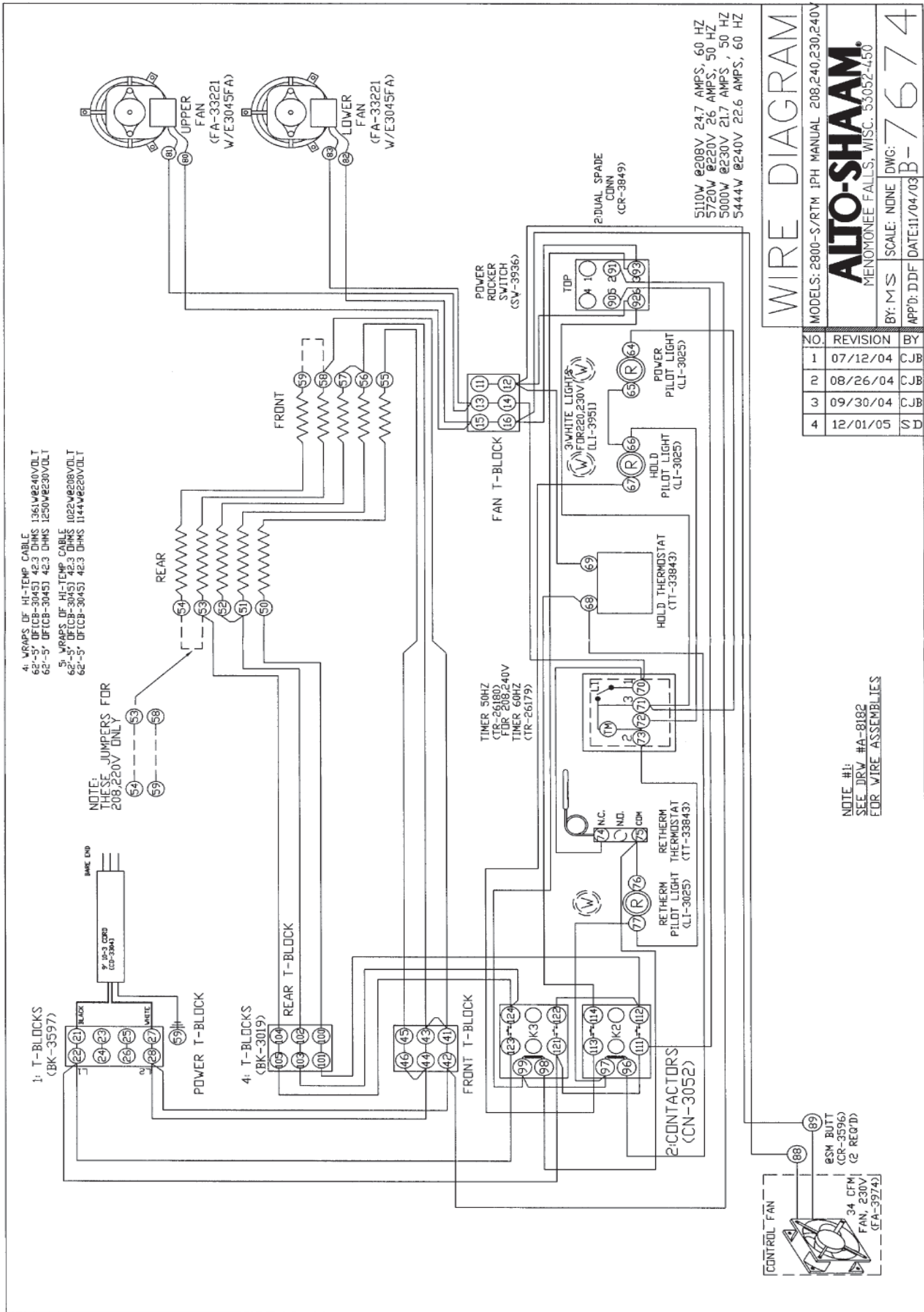

# WIRE DIAGRAM

MODELS: 2800-S/RTM 1PH MANUAL 208,240,230,240V

NO	REVISION	BY
1	07/12/04	CJB
2	08/26/04	CJB
3	09/30/04	CJB
4	12/01/05	S/D

BY: M S SCALE: NONE DWG: B-7674  
APP'D: D DF DATE: 11/04/03

**AUTO-SHAAM**  
MENOMONEE FALLS, WISC. 53052-450

NOTE #1:  
SEE DRW #A-8182  
FOR WIRE ASSEMBLIES

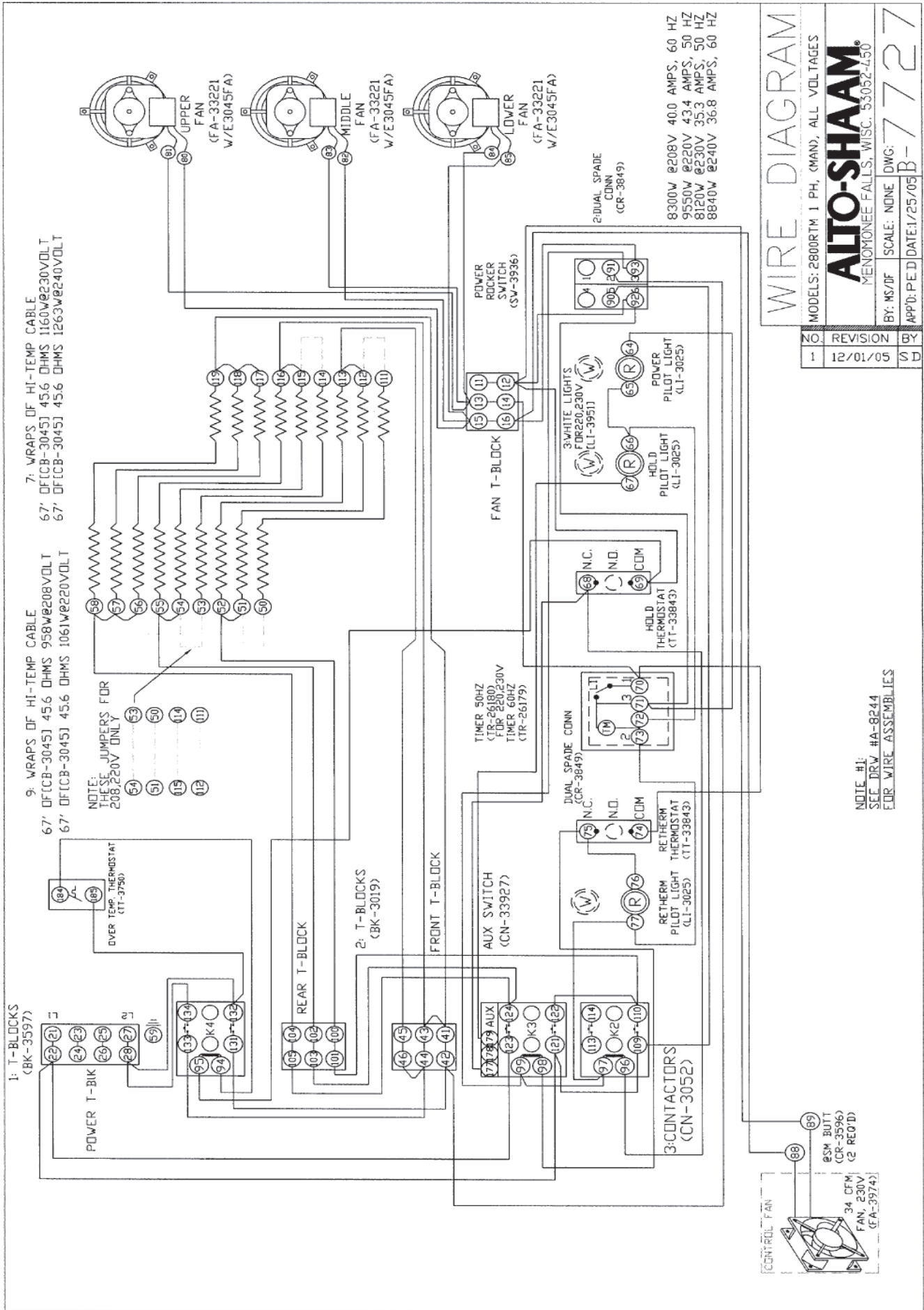

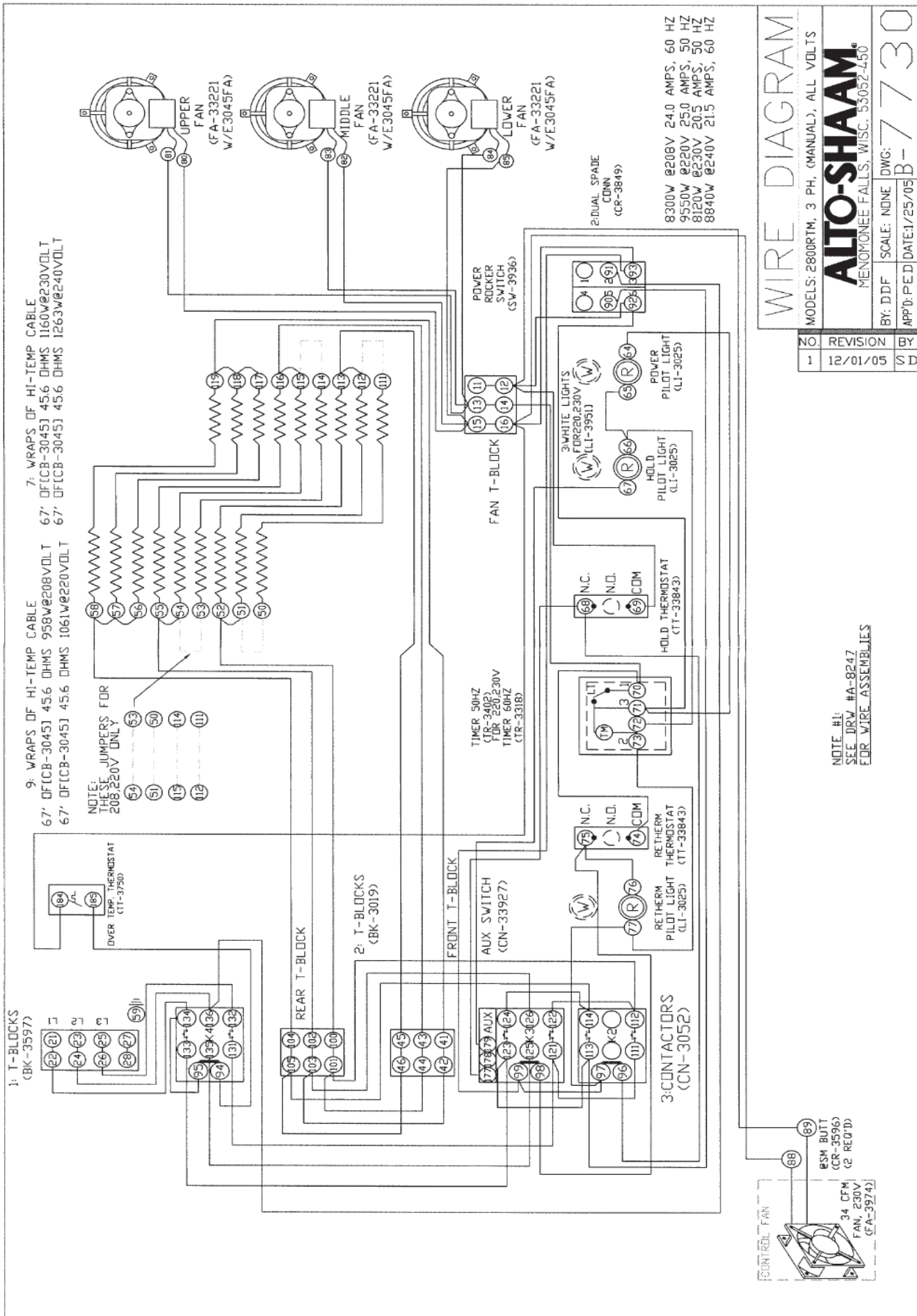

**WIRE DIAGRAM**

MODELS: 2800RTM, 3 PH. (MANUAL), ALL VOLTS

**ALTO-SHAAM**  
MEMONONEE FALLS, WISC. 53052-450

BY: DDF SCALE: NONE DWG: B-7730

APP'D: PED DATE: 1/25/05

NO	REVISION	BY
1	12/01/05	DD

NOTE: #1:  
SEE DRW #A-8247  
FOR WIRE ASSEMBLIES

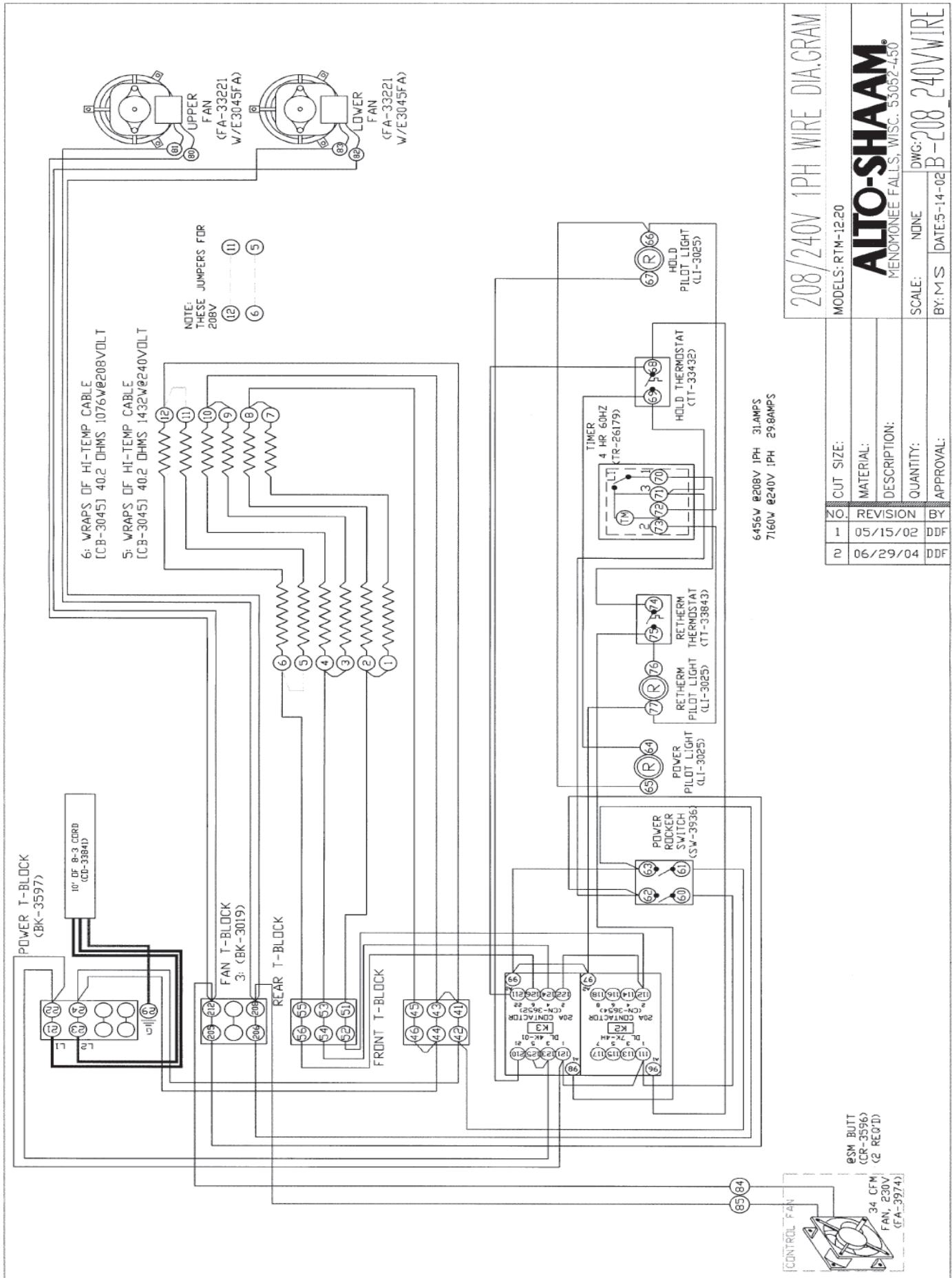

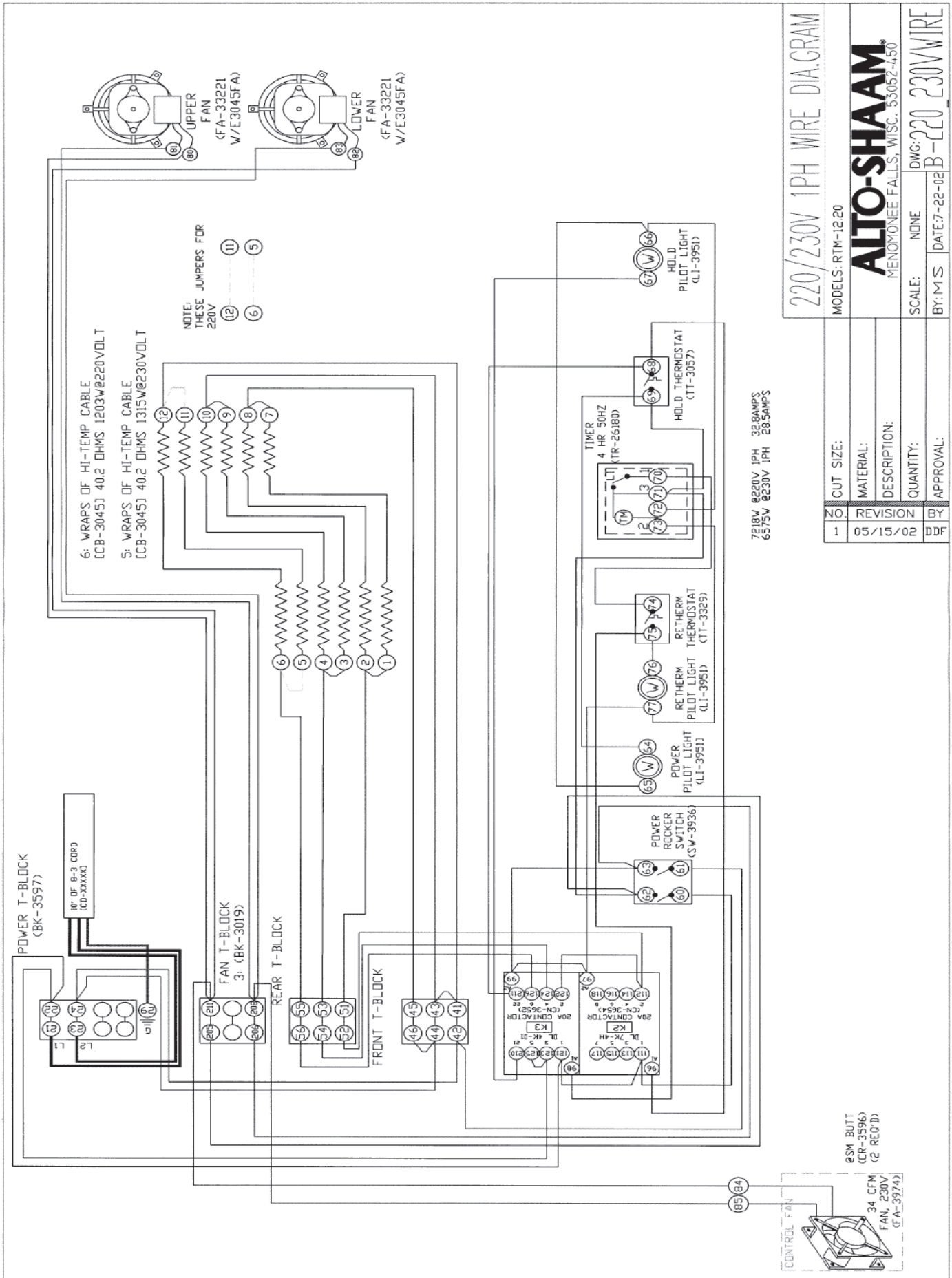

220/230V 1PH WIRE DIA.GRAM

MODELS: RTM-12-20

**ALTO-SHAM**  
 MENOMONEE FALLS, WISC. 53052-450

SCALE: NONE DWG: 220 230V WIRE  
 BY: M S DATE: 7-22-02

NO.	REVISION	BY	APPROVAL
1	05/15/02	DDF	

CUT SIZE:  
 MATERIAL:  
 DESCRIPTION:  
 QUANTITY:  
 APPROVAL:

# TRANSPORTATION DAMAGE and CLAIMS



All Alto-Shaam equipment is sold F.O.B. shipping point, and when accepted by the carrier, such shipments become the property of the consignee.

Should damage occur in shipment, it is a matter between the carrier and the consignee. In such cases, the carrier is assumed to be responsible for the safe delivery of the merchandise, unless negligence can be established on the part of the shipper.

1. Make an immediate inspection while the equipment is still in the truck or immediately after it is moved to the receiving area. Do not wait until after the material is moved to a storage area.
2. Do not sign a delivery receipt or a freight bill until you have made a proper count and inspection of all merchandise received.
3. Note all damage to packages directly on the carrier's delivery receipt.
4. Make certain the driver signs this receipt. If he refuses to sign, make a notation of this refusal on the receipt.
5. If the driver refuses to allow inspection, write the following on the delivery receipt:  
*Driver refuses to allow inspection of containers for visible damage.*
6. Telephone the carrier's office immediately upon finding damage, and request an inspection. Mail a written confirmation of the time, date, and the person called.
7. Save any packages and packing material for further inspection by the carrier.
8. Promptly file a written claim with the carrier and attach copies of all supporting paperwork.

We will continue our policy of assisting our customers in collecting claims which have been properly filed and actively pursued. We cannot, however, file any damage claims for you, assume the responsibility of any claims, or accept deductions in payment for such claims.

# ALTO SHAAM. LIMITED WARRANTY

Alto-Shaam, Inc. warrants to the original purchaser that any original part that is found to be defective in material or workmanship will, at Alto-Shaam's option, subject to provisions hereinafter stated, be replaced with a new or rebuilt part.

The labor warranty remains in effect one (1) year from installation or fifteen (15) months from the shipping date, whichever occurs first. Alto-Shaam will bear normal labor charges performed during standard business hours, and excluding overtime, holiday rates or any additional fees.

The parts warranty remains in effect for one (1) year from installation or fifteen (15) months from the shipping date, whichever occurs first.

However, the heating element on Halo Heat<sup>®</sup> cook/hold ovens and the refrigeration compressor on Alto-Shaam Quickchillers<sup>™</sup> are warranted for a period of five (5) years from installation. The labor warranty is the same as stated above; namely, for one (1) year from installation or fifteen (15) months from the shipping date, whichever occurs first.

### THIS WARRANTY DOES NOT APPLY TO:

1. Calibration.
2. Replacement of light bulbs and/or the replacement of display case glass due to damage of any kind.
3. Equipment damage caused by accident, shipping, improper installation or alteration.
4. Equipment used under conditions of abuse, misuse, carelessness or abnormal conditions including, but not limited to, equipment subjected to harsh or inappropriate chemicals including, but not limited to, compounds containing chloride or quaternary salts, poor water quality, or equipment with missing or altered serial numbers.
5. Damage incurred as a direct result of poor water quality, inadequate maintenance of steam generators and/or surfaces affected by water quality. Water quality and required maintenance of steam generating equipment is the responsibility of the owner/operator.
6. Damage caused by use of any cleaning agent other than Alto-Shaam's Combitherm<sup>®</sup> Cleaner including, but not limited to, damage due to chlorine or other harmful chemicals. Use of Alto-Shaam's Combitherm<sup>®</sup> Cleaner on Combitherm<sup>®</sup> ovens is highly recommended.
7. Any losses or damage resulting from malfunction, including loss of product or consequential or incidental damages of any kind.
8. Equipment modified in any manner from original model, substitution of parts other than factory authorized parts, removal of any parts including legs, or addition of any parts.

This warranty is exclusive and is in lieu of all other warranties, expressed or implied, including the implied warranties of merchantability and fitness for a particular purpose. In no event shall Alto-Shaam be liable for loss of use, loss of revenue or profit, or loss of product, or for any indirect or consequential damages. No person except an officer of Alto-Shaam, Inc. is authorized to modify this warranty or to incur on behalf of Alto-Shaam any other obligation or liability in connection with Alto-Shaam equipment.

**ALTO-SHAAM, INC.**

RECORD THE MODEL AND SERIAL NUMBER OF THE APPLIANCE FOR EASY REFERENCE.  
ALWAYS REFER TO BOTH MODEL AND SERIAL NUMBER IN ANY CONTACT WITH ALTO-SHAAM REGARDING THIS APPLIANCE.

Model: \_\_\_\_\_ Date Installed: \_\_\_\_\_  
Voltage: \_\_\_\_\_ Purchased From: \_\_\_\_\_  
Serial Number: \_\_\_\_\_

**W164 N9221 Water Street • P.O. Box 450 • Menomonee Falls, Wisconsin 53052-0450 • U.S.A.**

PHONE: 262.251.3800 • 800.558-8744 USA/CANADA

FAX: 262.251.7067 • 800.329.8744 U.S.A. ONLY

WEBSITE: [www.alto-shaam.com](http://www.alto-shaam.com)

PRINTED IN U.S.A.