

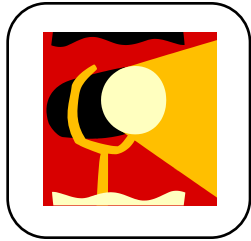

JetwaveTM
High Speed
Combination Oven

SERVICE/TRAINING MANUAL



**FEATURES &
OVERVIEW**

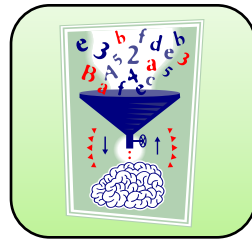

SPECIFICATIONS



INSTALLATION



SAFETY



**COMPONENT
LOCATIONS**



**COMPONENT
ACCESS**



**SERVICE TEST MODE
& USER OPTIONS**



**POWER OUTPUT
TEST**

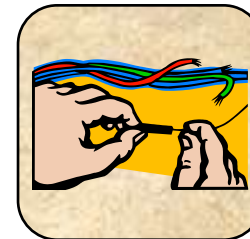

WIRING INFORMATION



RESOURCES

Table of Contents

FEATURES & OVERVIEW	
Features & Overview	3
SPECIFICATIONS	
Specifications	4
INSTALLATION	
Clearances and Placement	5
Radio Interference	6
Earthing Instructions	7
SAFETY	
Microwave Service	8
Discharging Capacitors	9
Microwave Emissions	10
COMPONENT LOCATIONS	
Front	12
Right Side	13
Left Side	14
Bottom	15
Top	16
Door	17
COMPONENT ACCESS	
Antenna/Stirrers	19
Blower Fan Motor	23
Control Board	26
Convection Fan Motor	28
Display Board	31
Fuse	32
Catalyst Assy.	33

COMPONENT ACCESS cont'd

Heater Box/Heater	35
Interlock Switch	40
Monitor Relay Board	42
Power Relay	44
RTD	46
Thermal Cutouts	47
Triacs	51
<i>HIGH VOLTAGE COMPONENTS</i>	
Capacitors & Diodes	53
High Voltage Transformer	57
Magnetron	60
SERVICE TEST MODE & USER OPTIONS	
Service Test Mode	64
User Options	65
POWER OUTPUT TEST	
Power Output Test	66
WIRING INFORMATION	
Diagram	67
Schematic	68
RESOURCES	
ACP Service Solutions	69

SPECIFICATIONS

Models	JET14*	JET19*	JET514
Power Source			
Voltage AC	208-240 VAC	208-240 VAC	230 VAC
Amperage (Single Unit)	16 A	26 A	16 A
Frequency	60 Hz	60 Hz	50 Hz
Single Phase, 3 wire grounded	YES	YES	YES
Receptacle	6-20R	6-30R	CEE5/7
Plug	6-20P	6-30P	Schuko
Power Output – Microwave			
Nominal microwave energy (IEC705)	1400 Watts	1900 Watts	1400 Watts
Minimum temperature rise	14°F / 7.5°C	19°F / 10.5°C	14°F / 7.5°C
Power Consumption			
Amps	16 Amps	26 Amps	13 Amps
Watts	3200 Watts	5300 Watts	2900 Watts
Dimensions			
Cabinet (in / cm)			
Width	19 3/4" 50 cm	19 3/4" 50 cm	19 3/4" 50 cm
Height	18 1/8" 46 cm	18 1/8" 46 cm	18 1/8" 46 cm
Depth	26 " 66 cm	26 " 66 cm	26 " 66 cm
Oven Interior (in / cm)			
Width	13" 33 cm	13" 33 cm	13" 33 cm
Height	10 1/2" 27 cm	10 1/2" 27 cm	10 1/2" 27 cm
Depth	15" 38 cm	15" 38 cm	15" 38 cm
Weight			
Crated	102 lbs. 46 kg.	102 lbs. 46 kg.	102 lbs. 46 kg.
Uncrated	95 lbs. 43 kg.	95 lbs. 43 kg.	95 lbs. 43 kg.

INSTALLATION

Oven Clearances

A—For North American (UL/CSA) models, allow at least 2" (5.1 cm) of clearance around top of oven. For International (50 Hz) models, allow at least 7" (17.8 cm) of clearance around top of oven. Proper air flow around oven cools electrical components. With restricted air flow, oven may not operate properly and life of electrical parts is reduced.

B—Allow at least 2 9/16" (6.5 cm) between air discharge on back of oven and back wall.

C—Allow at least 1 1/4" (3 cm) of clearance around sides of oven.

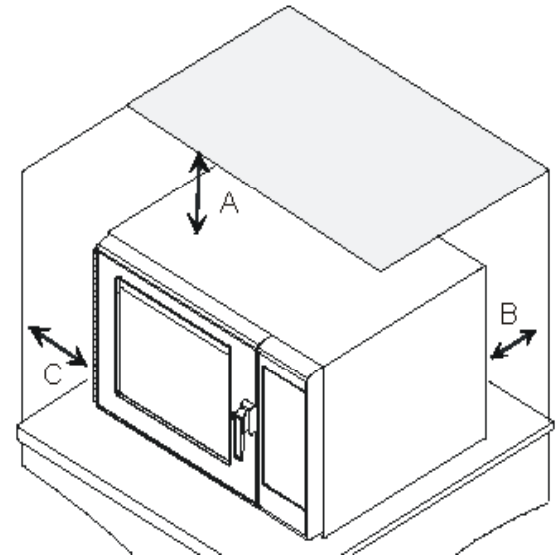

Oven Placement

- Do not install oven next to or above source of heat, such as pizza oven or deep fat fryer. This could cause microwave oven to operate improperly and could shorten life of electrical parts.
- Do not block or obstruct oven filter. Allow access for cleaning.
- Install oven on level countertop surface.
- If provided, place warning label in a conspicuous place close to microwave oven.
- Outlet should be located so that plug is accessible when oven is in place.



INSTALLATION

Radio Interference

Microwave operation may cause interference to radio, television, or a similar oven. Reduce or eliminate interference by doing the following:

- Clean door and sealing surfaces of oven according to instructions in *Care and Cleaning* section.
- Place radio, television, etc. as far as possible from oven.
- Use a properly installed antenna on radio, television, etc. to obtain stronger signal reception.



INSTALLATION

Earthing Instructions

Oven MUST be grounded.

The plug must be plugged into an outlet that is properly installed and grounded. Consult a qualified electrician or servicer if grounding instructions are not completely understood, or if doubt exists as to whether the oven is properly grounded.

Do not use an extension cord.

If the product power cord is too short, have a qualified electrician install a three-slot receptacle.

This oven should be plugged into a separate circuit with the electrical rating as provided in product specifications. When the combination oven is on a circuit with other equipment, an increase in cooking times may be required and fuses can be blown.

External Equipotential Earthing Terminal (*export only*)

Equipment has secondary earthing terminal. Terminal provides external earthing connection used in addition to earthing prong on plug. Located on outside of oven back, terminal is marked with symbol shown at right.

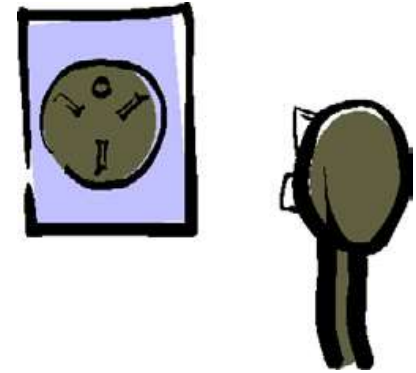

SAFETY – MICROWAVE SERVICE

Microwave Ovens produce voltage up to -5000 volts DC!

Microwave Oven Capacitors can store high voltage even with oven unplugged!

Always discharge capacitors whenever checking high voltage components!

Always disconnect the power supply before servicing!

NEVER perform high voltage tests!

Wear appropriate eye and hand protection!

Follow safety precautions in Product and Service literature!

Test oven operation after repairs are completed!

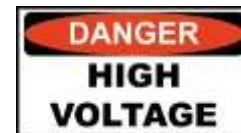

SAFETY - DISCHARGING CAPACITORS

ALWAYS DISCHARGE CAPACITORS BY SHORTING TERMINALS USING AN INSULATED TOOL(S)



CAPACITORS CAN HOLD HIGH
VOLTAGE EVEN WHEN POWER TO
OVEN IS DISCONNECTED!

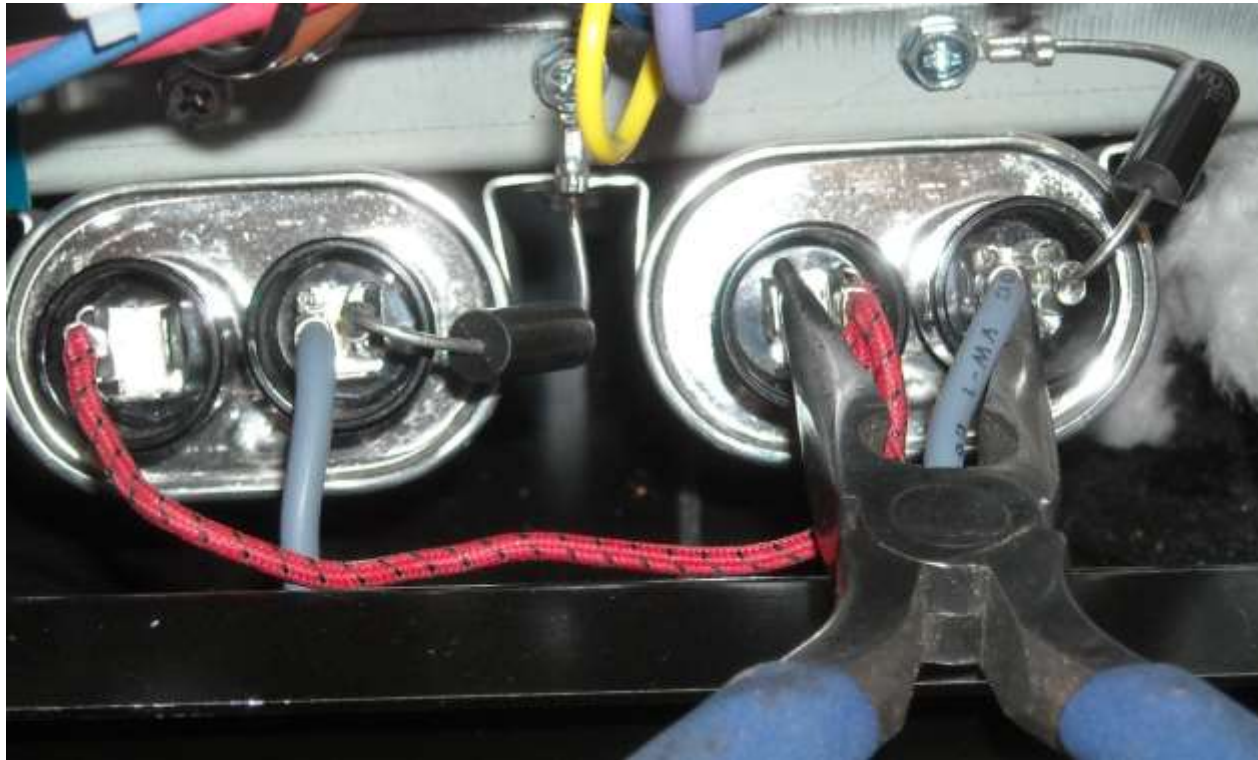

SAFETY – MICROWAVE EMISSIONS

FOOD AND DRUG ADMINISTRATION DEPARTMENT OF HEALTH AND HUMAN SERVICES SUBCHAPTER J – RADIOLOGICAL HEALTH

PART 1030 -- PERFORMANCE STANDARDS FOR MICROWAVE AND RADIO FREQUENCY EMITTING PRODUCTS

Sec. 1030.10 Microwave ovens.

. . . .

(v) One (the primary) required safety interlock shall prevent microwave radiation emission in excess of the requirement of paragraph (c)(1) of this section; the other (secondary) required safety interlock shall prevent microwave radiation emission in excess of 5 milliwatts per square centimeter at any point 5 centimeters or more from the external surface of the oven. The two required safety interlocks shall be designated as primary or secondary in the service instructions for the oven.

Precautions To Be Observed Before And During Servicing To Avoid Possible Exposure To Excessive Microwave Energy

. . . .

(e) A Microwave leakage check to verify compliance with the Federal performance standard should be performed on each oven prior to release to the owner.

NOTE: Other Government Agencies Have Same/Similar Standards

SAFETY – MICROWAVE EMISSIONS

To ensure the unit does not emit excessive microwave leakage and meets Government Agency guidelines, check the oven for microwave leakage using the Narda model 8100, 8200 Holaday HI1500, HI1501, or Simpson 380M leakage monitor as outlined in the instructions. The maximum leakage level allowed when following those instructions is 5mw/cm².



**MICROWAVE EMISSIONS DISPERSE RAPIDLY
ALL LEVELS ARE MEASURED PER SQUARE CENTIMETER**

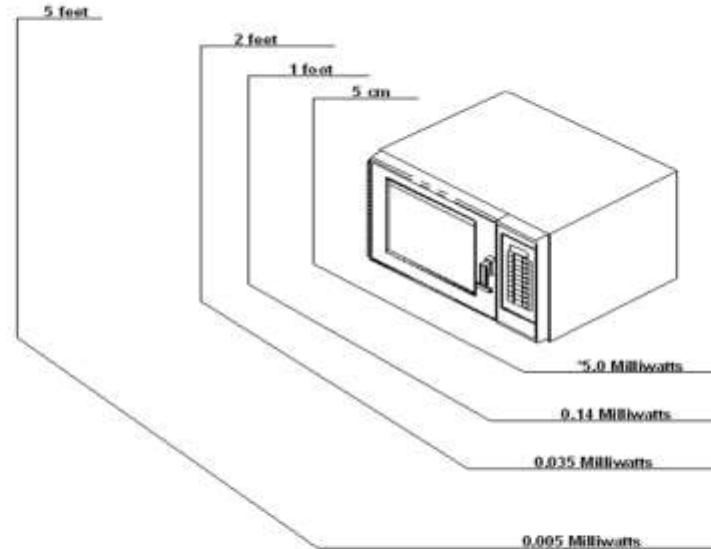

* 5.0 MILLIWATTS PER SQUARE CENTIMETER MEASURED 5 cm FROM THE OVEN IS THE U.S. PERFORMANCE STANDARD FOR THE LIFE OF A MICROWAVE OVEN.

Front View



Top Touch Panel

Side Touch Panel

Removable Air Filter & Drip Pan

Right Side View

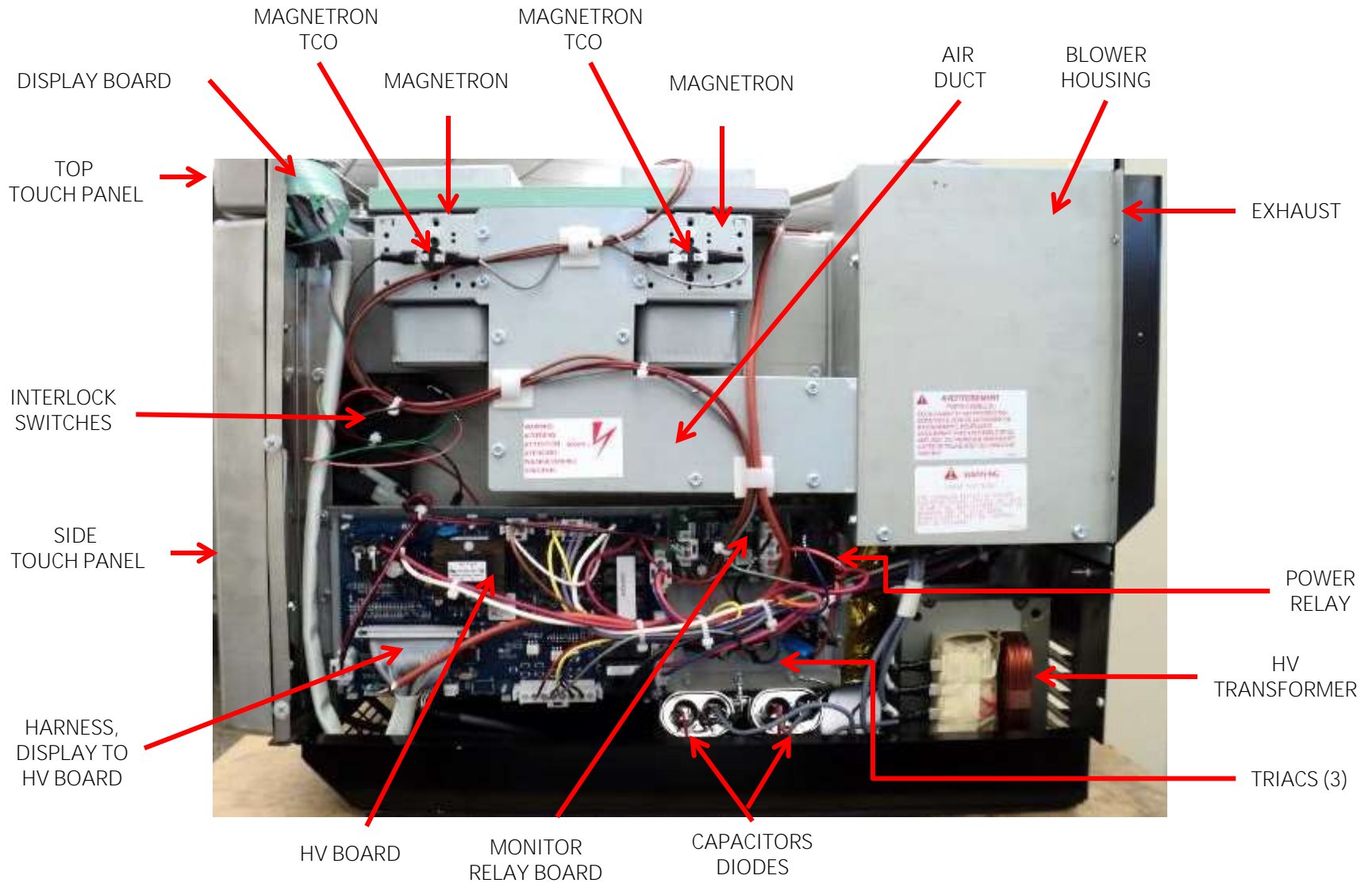

Left Side View

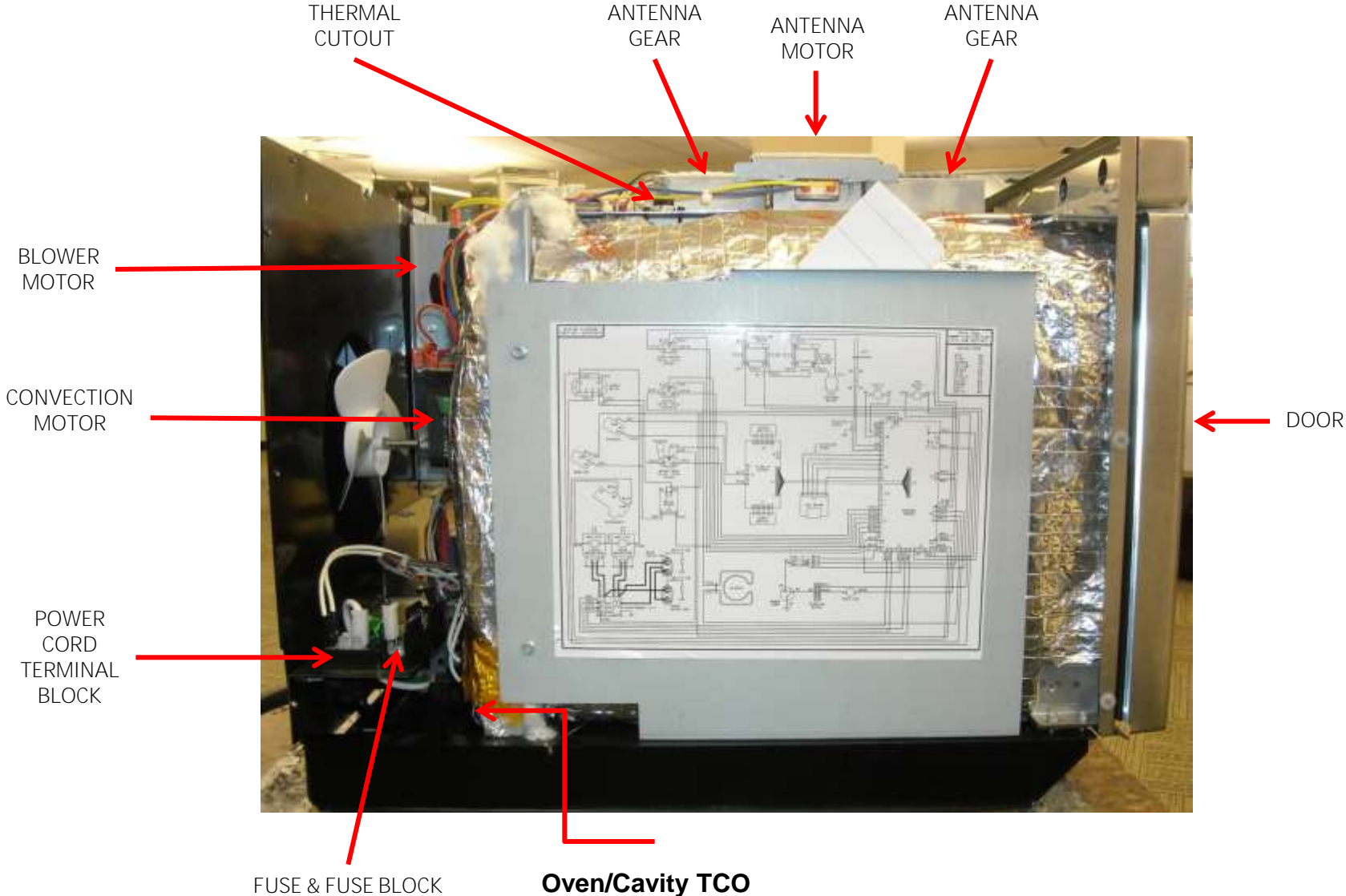

Bottom View

BOTTOM ANTENNA MOTOR ACCESS PANEL

USB PORT

REMOVABLE
AIR FILTER &
DRIP TRAY



Top View

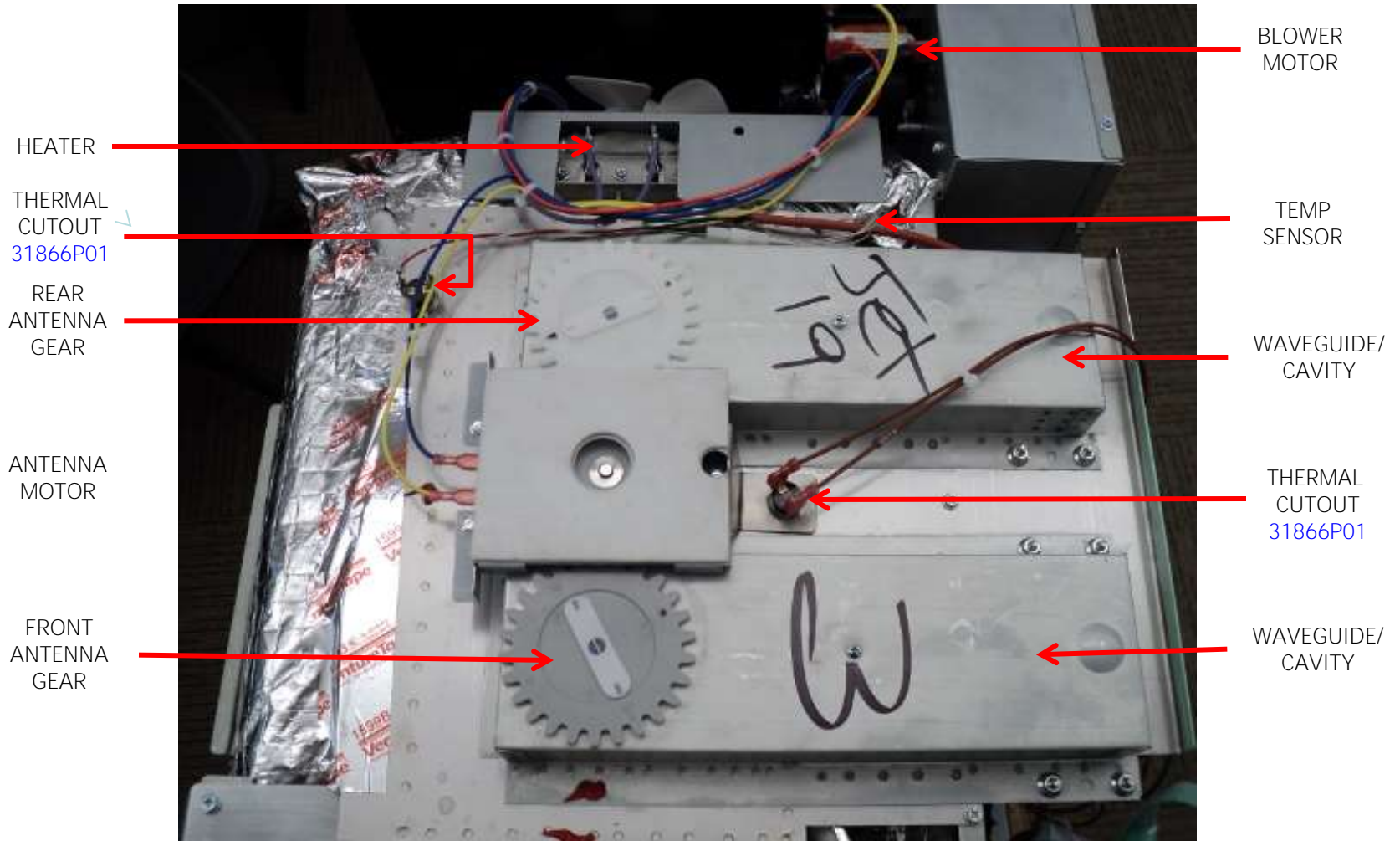

Note: Waveguide / Cavity is not replaceable

DOOR VIEW

TO ACCESS INNER DOOR COMPONENTS:
Remove 2 Crosshead Screws, 4 hole plugs,
and 4 #15 Torx Screws (one in each corner)
Then outer door can be removed from
inner door panel assembly.

LATCH ASSEMBLY

Screws

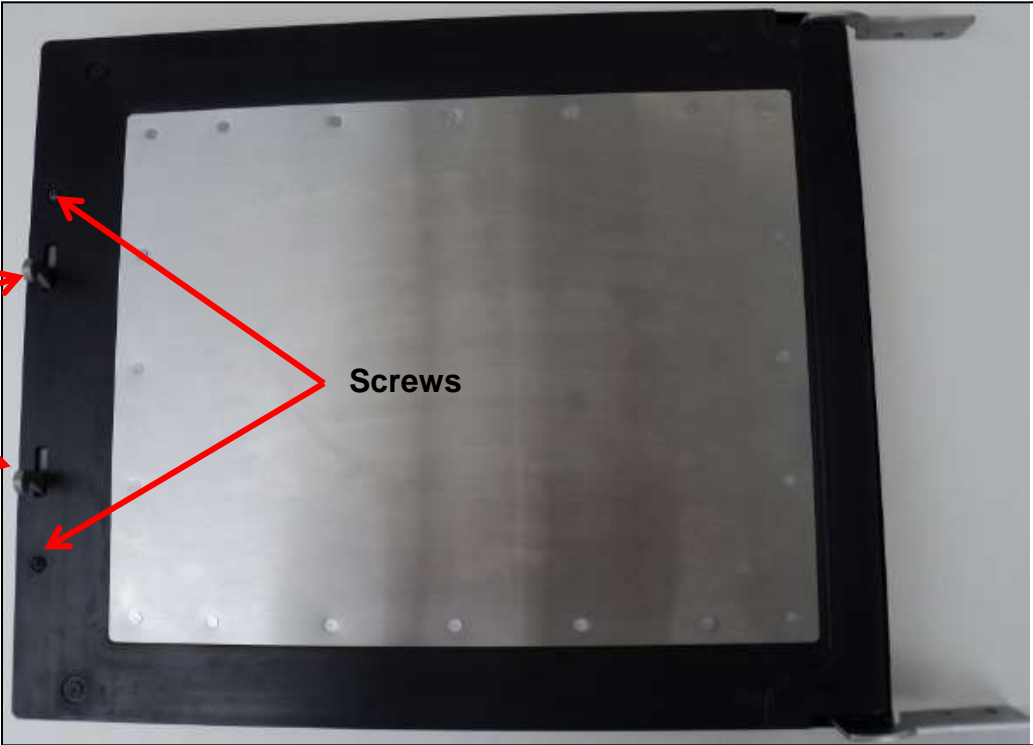

HOLE PLUG REMOVED

NOTE: If magnetized tools are not used, then it is recommended to have the door removed and lying flat, otherwise, screws may fall inside door weldment and be very difficult to retrieve.

DOOR VIEW

Two Components within the door assembly:
Door Hinge Spring found on the Upper Hinge Assembly (helps keep door open for easier food removal) and the Door Latch Assembly

DOOR SPRING

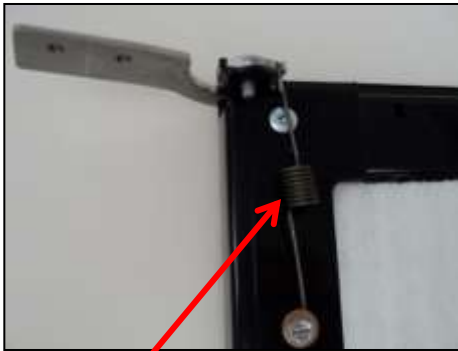

Upper Hinge Spring

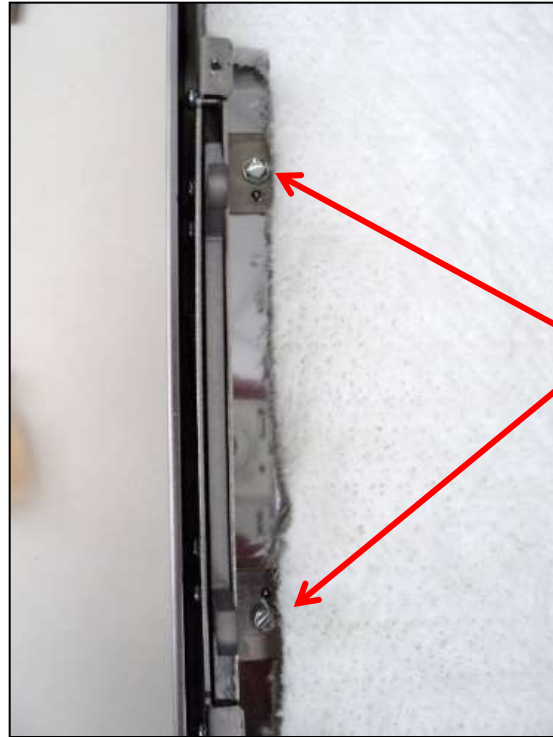

Mounting Screws

DOOR LATCH ASSEMBLY

ANTENNA/STIRRER – ACCESS

ANTENNA COVER
RETAINING CLIP (4)

ANTENNA COVER
(Ceramic)

Remove the four retainer
clips while supporting the
antenna cover

OVEN EXHAUST (2)

RACK

CONVECTION FAN
AIR INLET

OVEN TEMP SENSOR
RTD

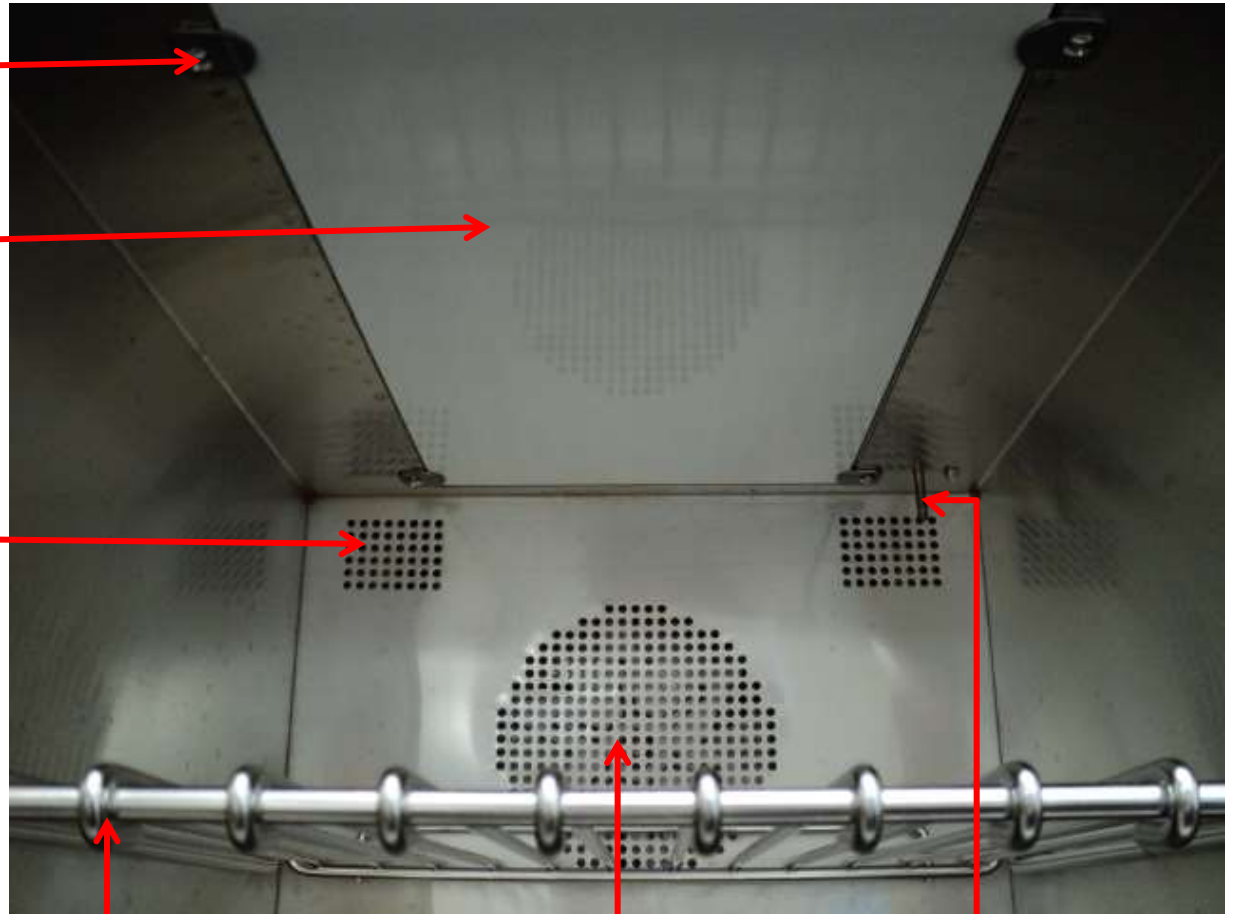

ANTENNA/STIRRER – Inside Cavity with Cover Removed

FRONT ANTENNA

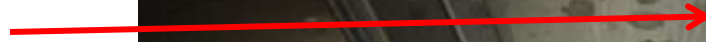

REAR ANTENNA



Note the positioning. Antennas
Should NEVER be in line with
each other

ANTENNA MOTOR – TESTING/REMOVAL

Terminal to Terminal - Approx. 12,000Ω

Note the position of top oven thermal cutout mounting bracket. The TCO should fit firmly to the top of the cavity

Disconnect wiring and
remove three securing screws
and lift off Antenna Motor Bracket

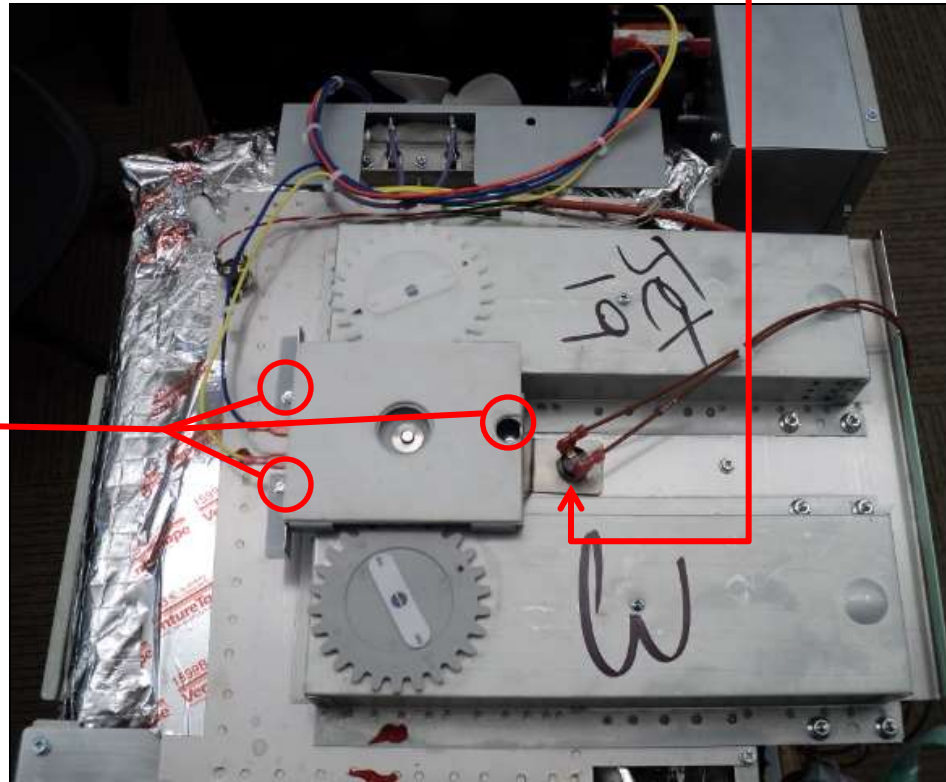

ANTENNA MOTOR – REMOVAL Cont'd

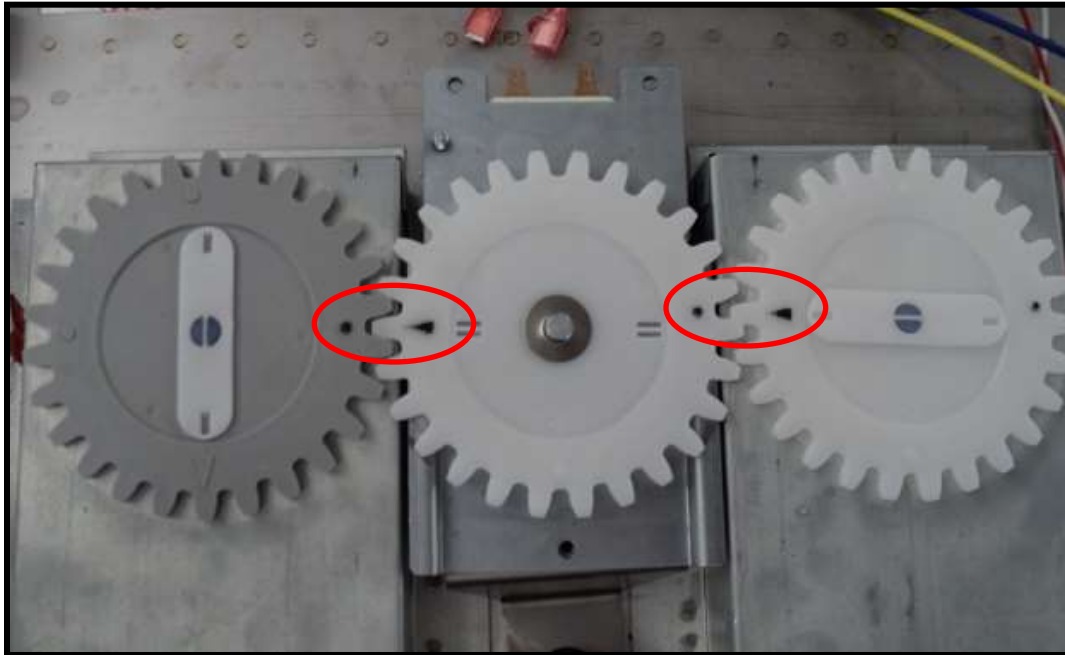

ENSURE PROPER ALIGNMENT

“Triangle to Dot to Triangle to Dot”

WHEN REASSEMBLING ANTENNA SYSTEM, THIS ENSURES PROPER ANTENNA POSITIONING INSIDE THE OVEN CAVITY

BLOWER MOTOR – RESISTANCE TESTING

60HZ Dual Voltage Rated Products

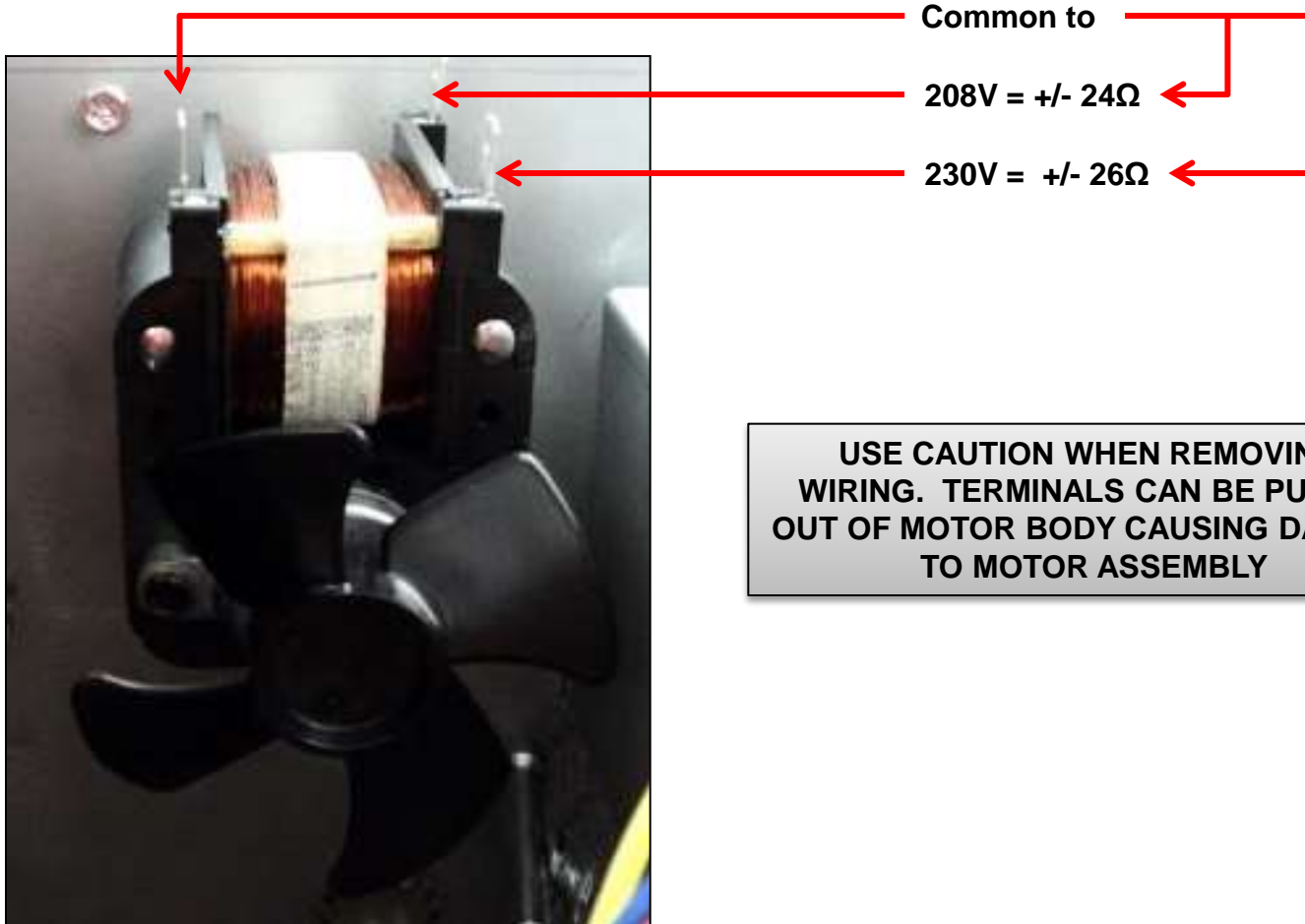

USE CAUTION WHEN REMOVING WIRING. TERMINALS CAN BE PULLED OUT OF MOTOR BODY CAUSING DAMAGE TO MOTOR ASSEMBLY

BLOWER MOTOR – VOLTAGE TESTING 60HZ Dual Voltage Rated Products

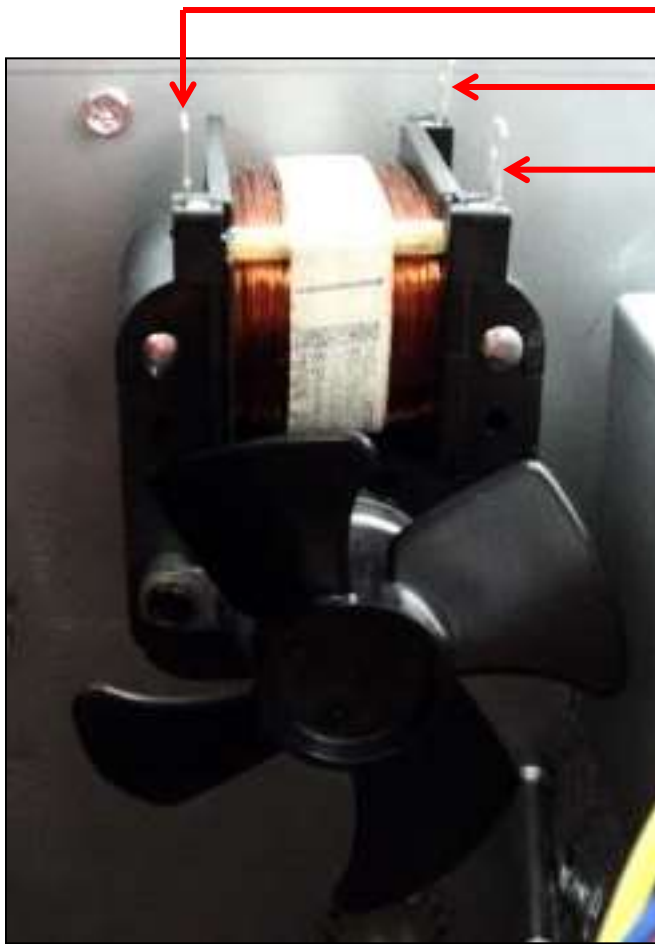

COMMON = LINE 1 via Board

LINE 2 (if 208vac) via Board

LINE 2 (if 230vac) via Board

**BLOWER MOTOR IS DUAL VOLTAGE RATED.
CONTROL BOARD SENSES INCOMING LINE
VOLTAGE AND SENDS TO MOTOR**

**USE CAUTION WHEN REMOVING
WIRING. TERMINALS CAN BE PULLED
OUT OF MOTOR BODY CAUSING DAMAGE
TO MOTOR ASSEMBLY**

BLOWER MOTOR - REMOVAL

- 1) Remove wiring (note wire locations)
- 2) Remove Blower Box Cover
- 3) Remove Blower Scroll Housing
- 4) Remove Blower Wheel Securing Screw (Securing Screw)
- 5) Remove two Blower motor mounting screws located behind blower wheel

BLOWER SCROLL HOUSING



BLOWER SCROLL HOUSING SECURING SCREWS

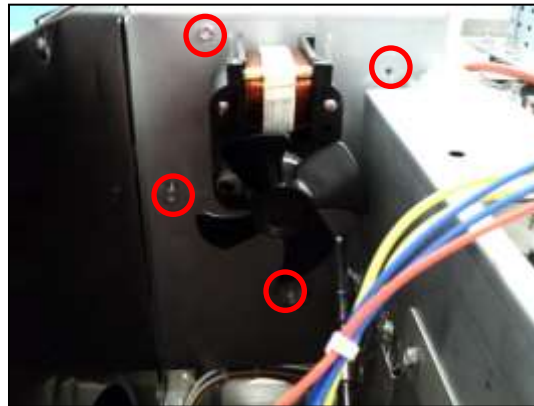

BLOWER WHEEL



ALLEN SCREW

CONTROL BOARD - Removal

Note wiring locations before removing wires.

Control Board mounts via clips.
Four along the top; 3 along the bottom.

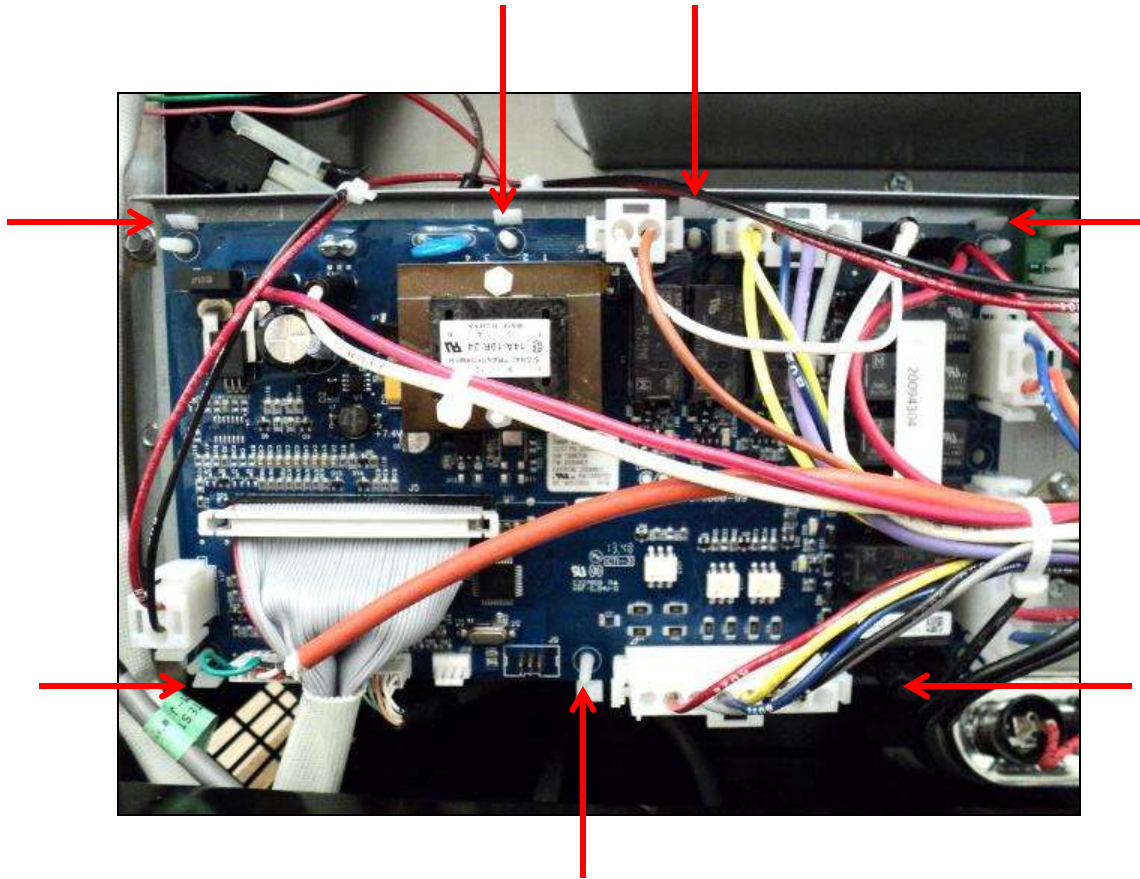

CONTROL BOARD – CONNECTOR LOCATIONS

(refer to wiring schematic)

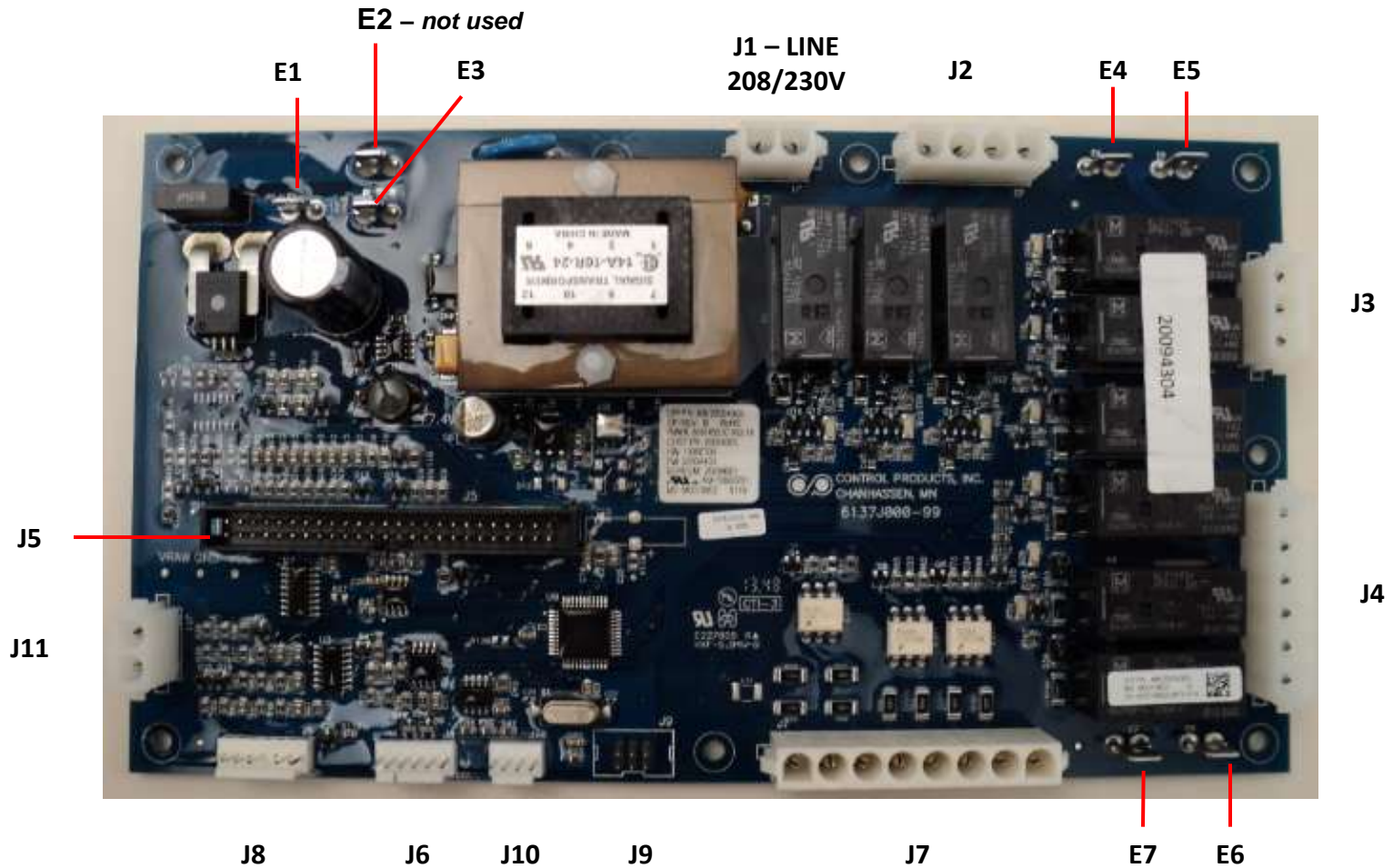

CONVECTION FAN – VOLTAGE TESTING

USE CAUTION WHEN REMOVING WIRING. TERMINALS CAN BE PULLED OUT OF MOTOR BODY CAUSING DAMAGE TO MOTOR ASSEMBLY

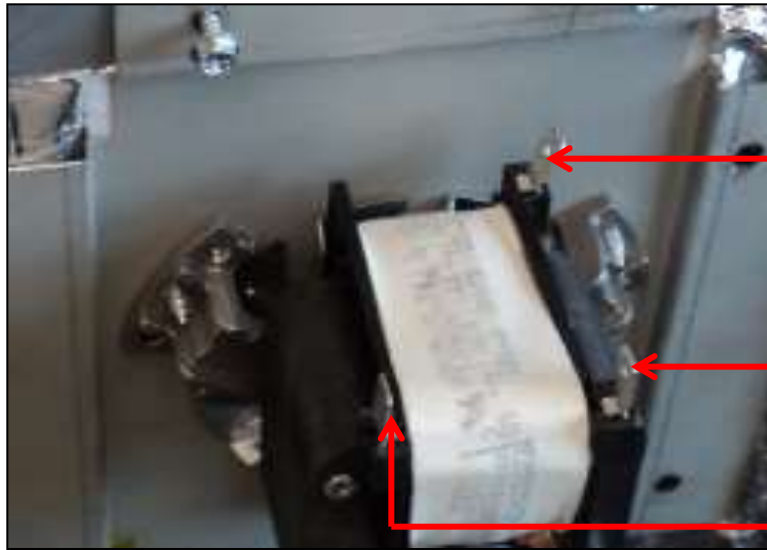

LINE 2 (if 208vac) via Board

LINE 2 (if 230vac) via Board

COMMON = LINE 1 via Triac

CONVECTION FAN MOTOR IS DUAL VOLTAGE RATED. CONTROL BOARD SENSES INCOMING LINE VOLTAGE AND SENDS TO MOTOR via TRIAC

CONVECTION FAN – RESISTANCE TESTING

USE CAUTION WHEN REMOVING WIRING. TERMINALS CAN BE PULLED OUT OF MOTOR BODY CAUSING DAMAGE TO MOTOR ASSEMBLY

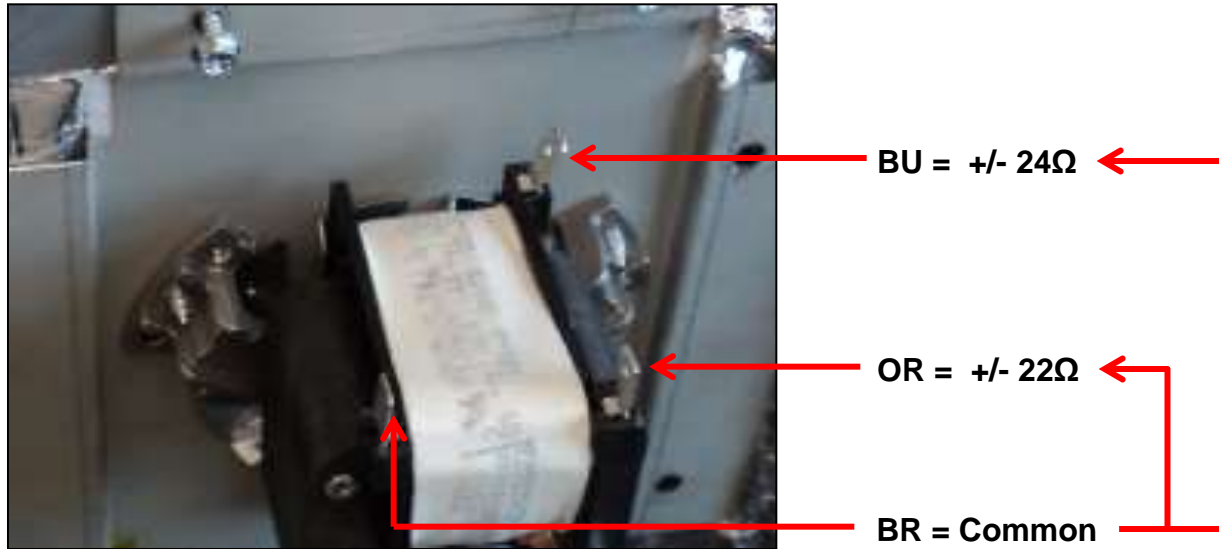

CONVECTION FAN MOTOR IS DUAL VOLTAGE RATED. CONTROL BOARD SENSES INCOMING LINE VOLTAGE AND SENDS TO MOTOR via TRIAC

CONVECTION FAN – REMOVAL

- 1) Remove Rear Fan Blade and wiring
- 2) Remove Heater Box Assembly
- 3) Remove Convection Fan Blade (1/2 in. Cap Nut)
(note order of clip, washers, and blade)
- 4) Remove three 5/16 in. securing screws
- 5) Remove Motor from Bracket and Insulation

1/2 IN. LEFT HAND THREAD !

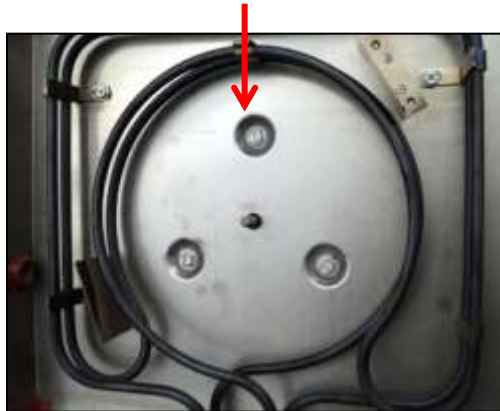

WHEN REASSEMBLING ENSURE PROPER MOTOR ORIENTATION. WIRE TERMINALS POINT TO THE TOP OF THE OVEN.



CONVECTION FAN INSULATION

CONVECTION FAN BRACKET



DISPLAY BOARD – CONNECTOR LOCATIONS

BACK

TOP TOUCH PANEL *(installed)*

SIDE
TOUCH
PANEL



HV/LV HARNESS

PROGRAM PORT *(Not Used)*

External Speaker *(Not Used)*

FRONT



SPEAKER

DISPLAY
SCREEN

FUSE – ACCESS/REMOVAL

← REAR OF UNIT

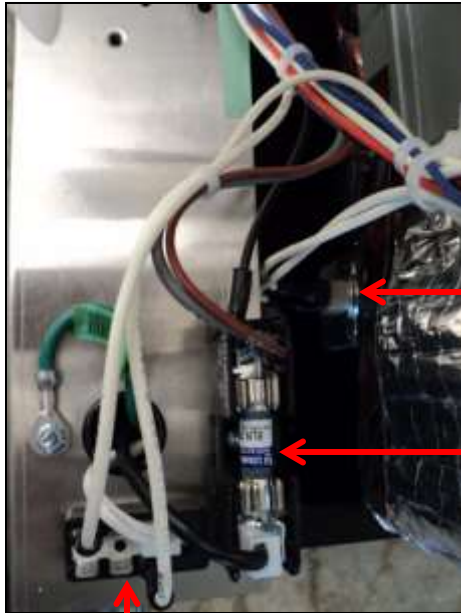

POWER CORD
TERMINAL BLOCK

OVEN
THERMAL
CUTOUT

FUSE &
FUSE BLOCK

An open main fuse caused by high amperage requires the replacement of the Monitor Relay Board since high current will cause the monitor relay board's contacts to stick. This is a UL requirement.

Ensure fuse fits firmly in the fuse block.

CATALYST ASSY - ACCESS/REMOVAL

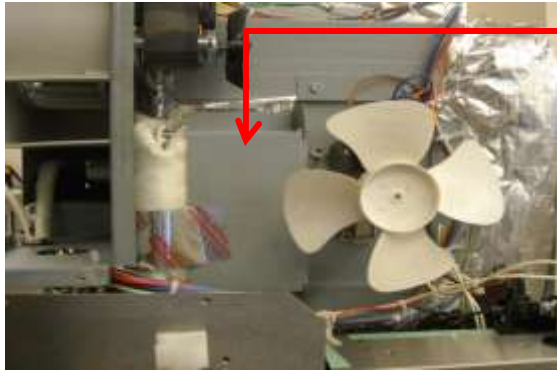

HOUSING

**Remove blower and
air duct cover**

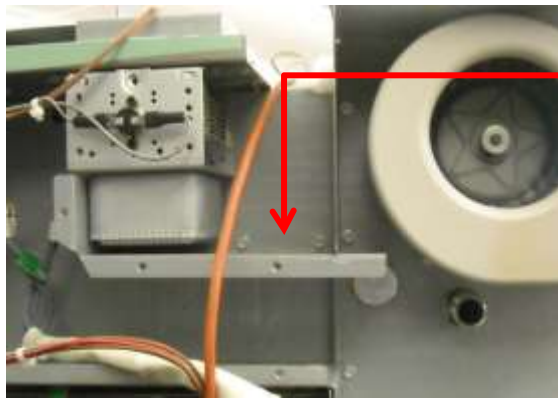
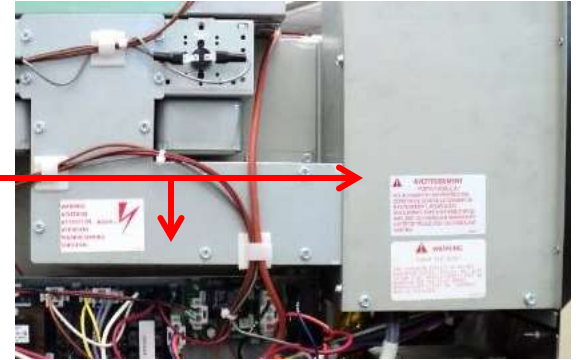

**Remove duct top and
blower motor assy.**

**Fold insulation away
from catalyst assy.
to access screws**

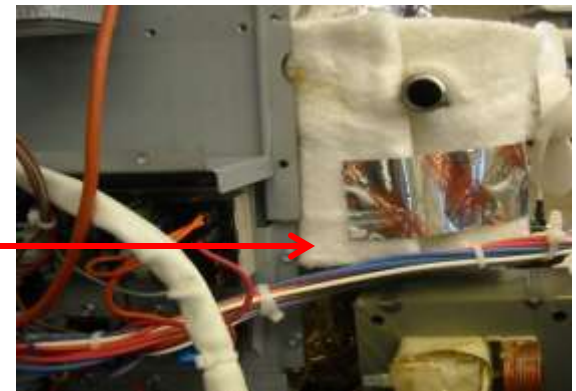

CATALYST ASSY - ACCESS/REMOVAL

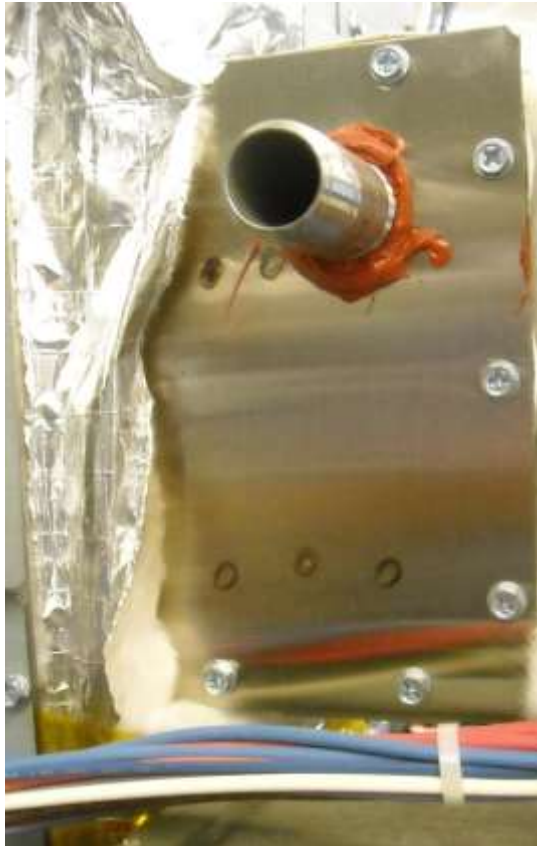

Remove screws (10) 
slide out of housing

Has high temperature
gasket part # [59134320](#)



HEATER BOX – ACCESS to Heater & Convection Fan Motor

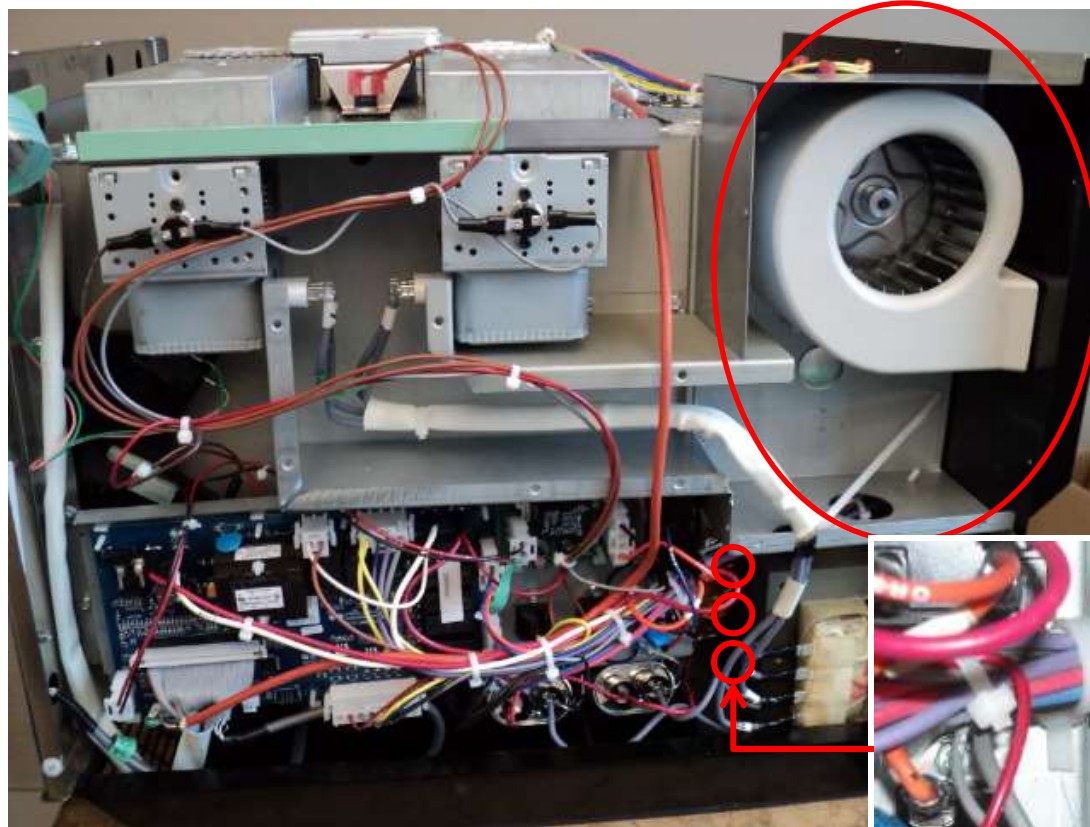

**Remove Blower
Motor Housing
Assembly**

**Remove three (3) rear ¼ inch Machine
Compartment Bracket screws for the
Heater Box**



HEATER BOX – ACCESS 2

Do Not Tear or Remove
the protective High
Voltage Polymide Tape
part # M0275051

Remove High Voltage
Transformer

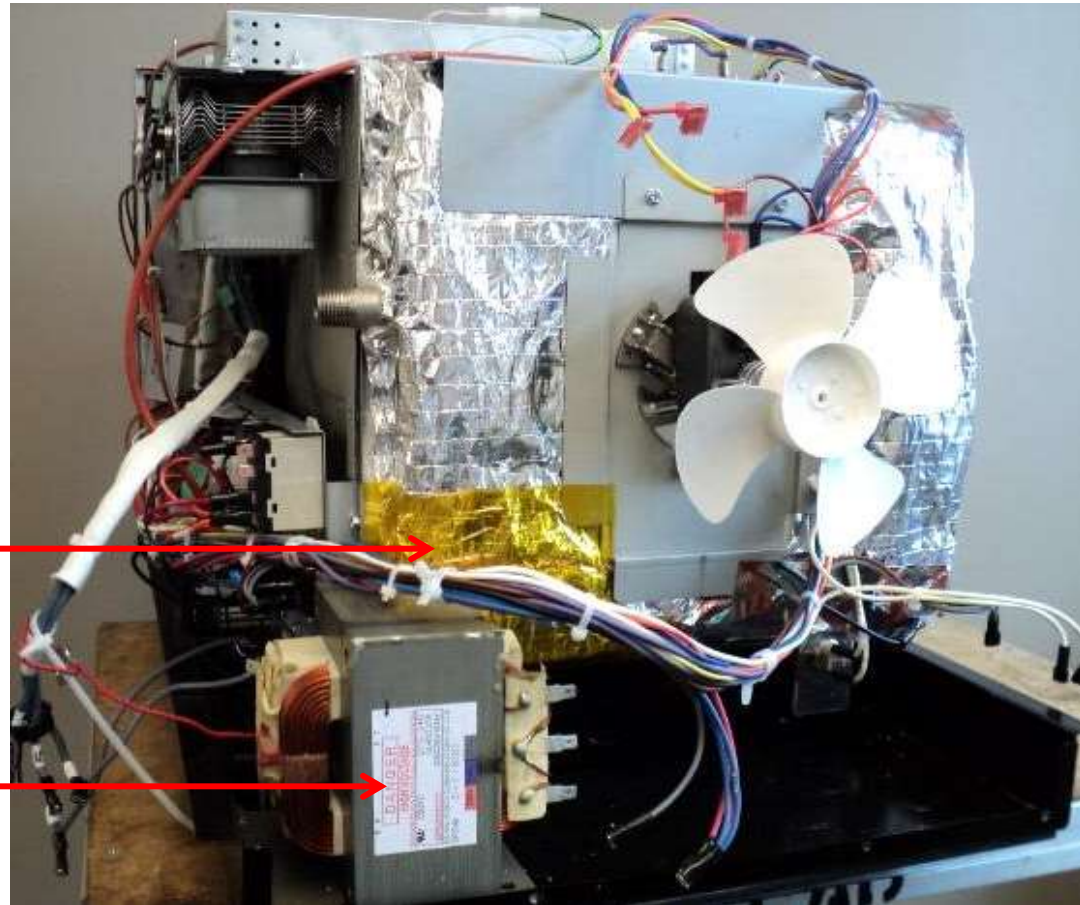

Remove High Voltage Transformer by removing wiring
(noting wire location), sliding out of base and lifting out

HEATER BOX – ACCESS 3

Remove Back, High Voltage Transformer, Blower Assembly Housing, and the three (3) rear board bracket screws

TAPE*
Carefully cut tape and pull the insulation from the perimeter of the heater box

Remove Heater Wiring
And Two Convection
Motor Mounting Screws

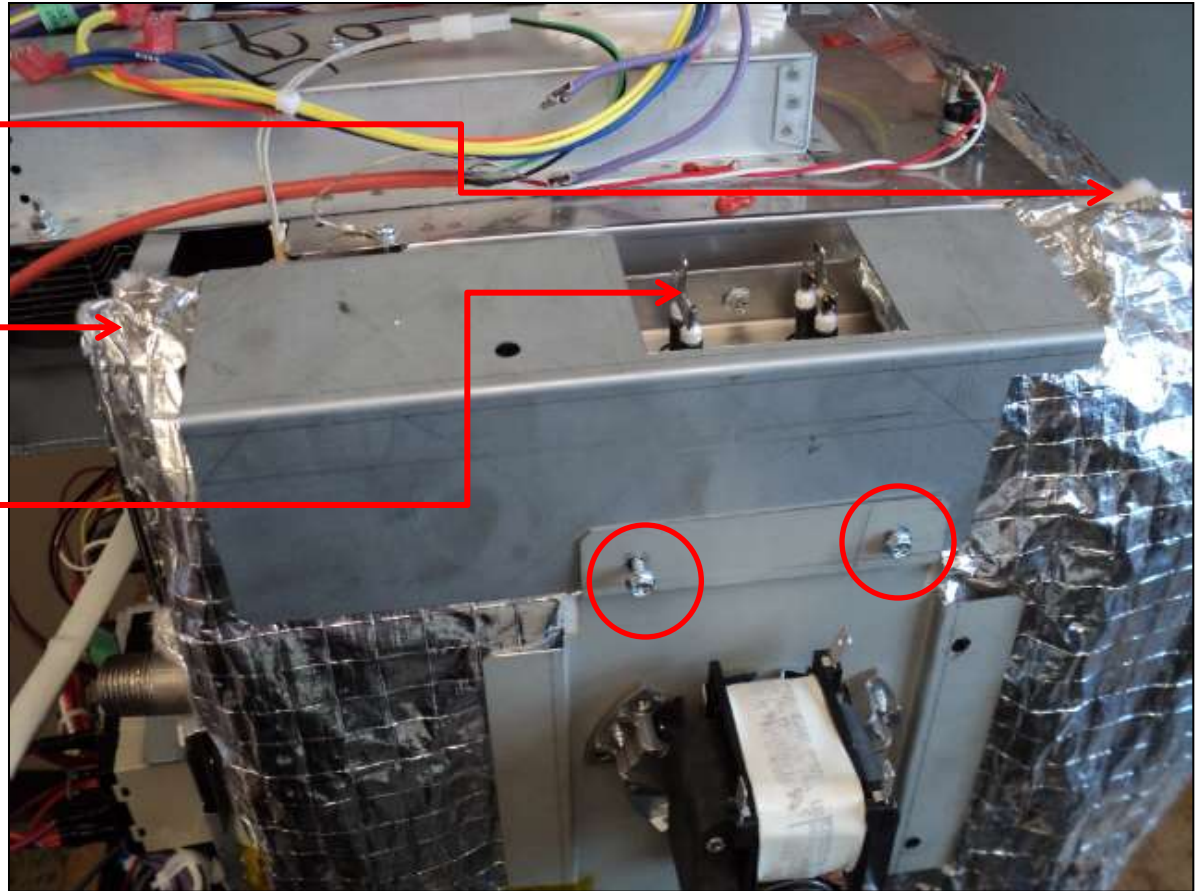

* 15' Roll of Tape Part Number [M0275089](#)

HEATER BOX – REMOVED

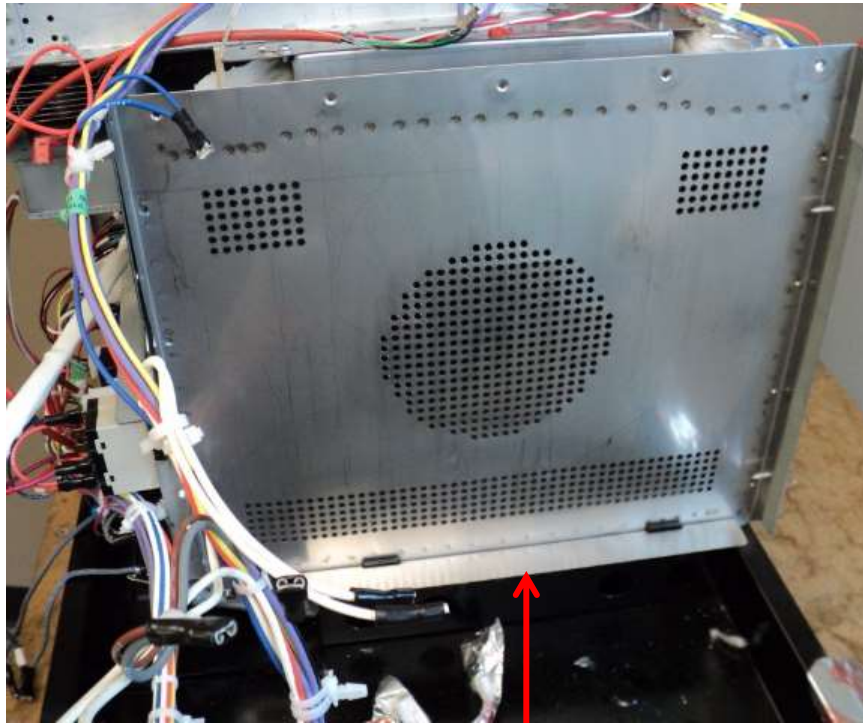

GREASE CHANNEL

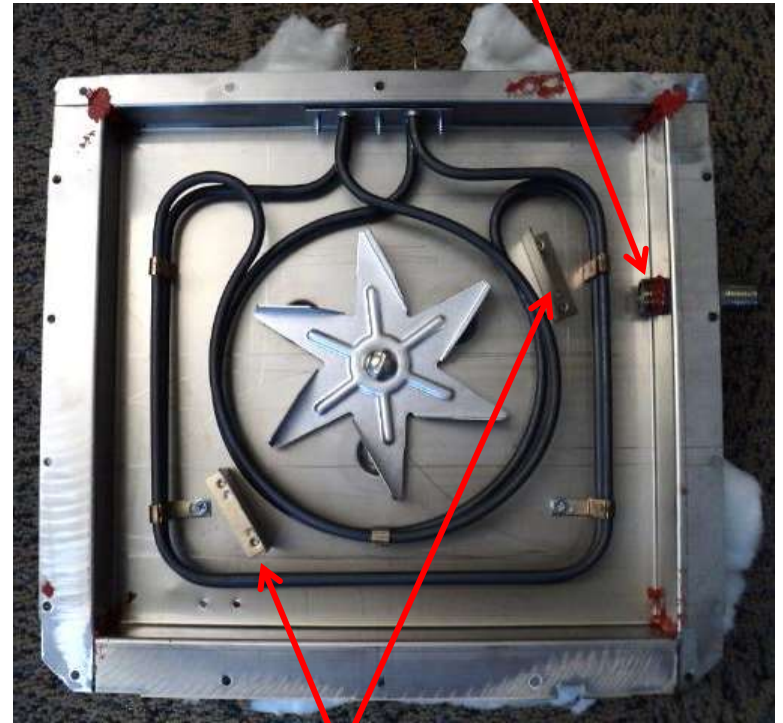

EXHAUST

SPACERS

HEATER



**ALWAYS USE CAUTION WHEN
MAKING LIVE VOLTAGE TESTS**

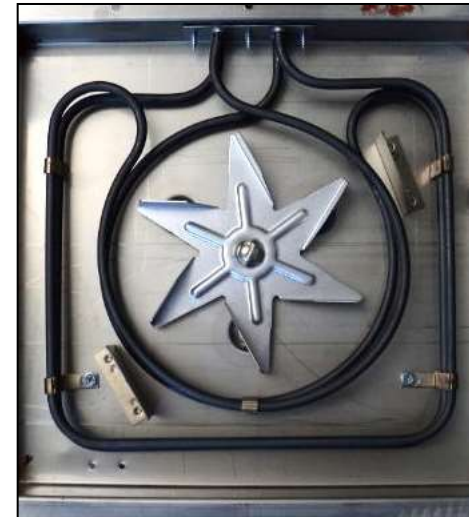
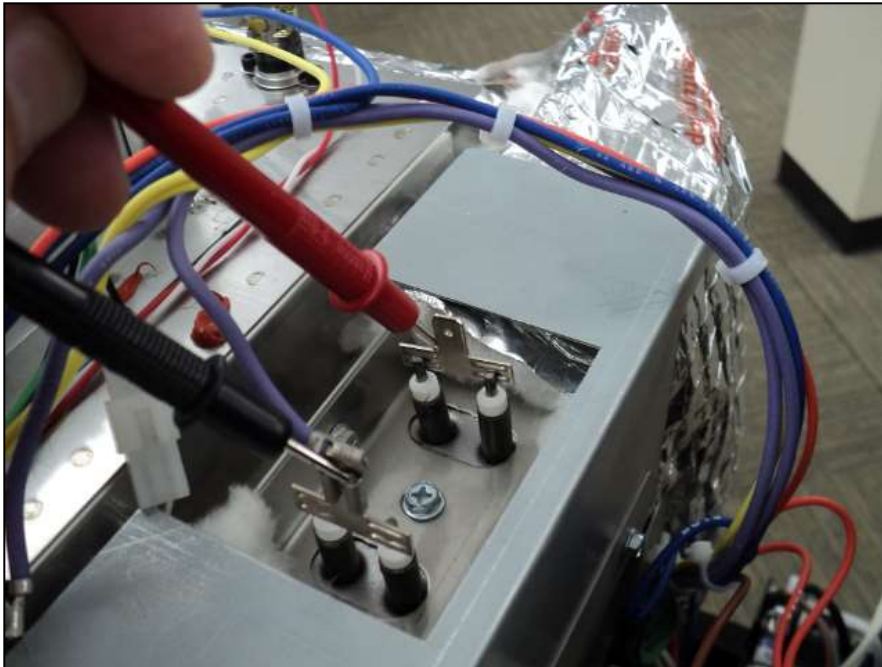

Ohm/Resistance Test

**Terminal to Terminal with at least one wire
Disconnected = +/- 16 Ω**

Voltage Testing with Component On

**Terminal to Terminal with wires
securely attached = Line Voltage**

INTERLOCK SWITCH ASSEMBLY - Removal

With Door Open,
Remove two (2) screws

Remove Bracket
Screw

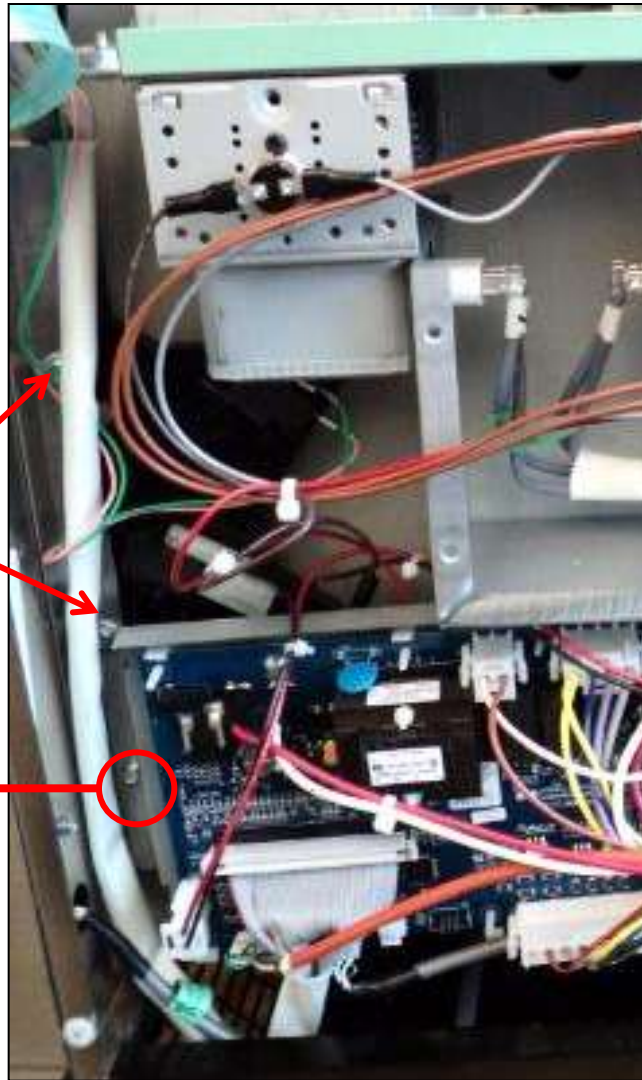

Assembly can be
lifted up and out

INTERLOCK SWITCH ASSEMBLY - Testing

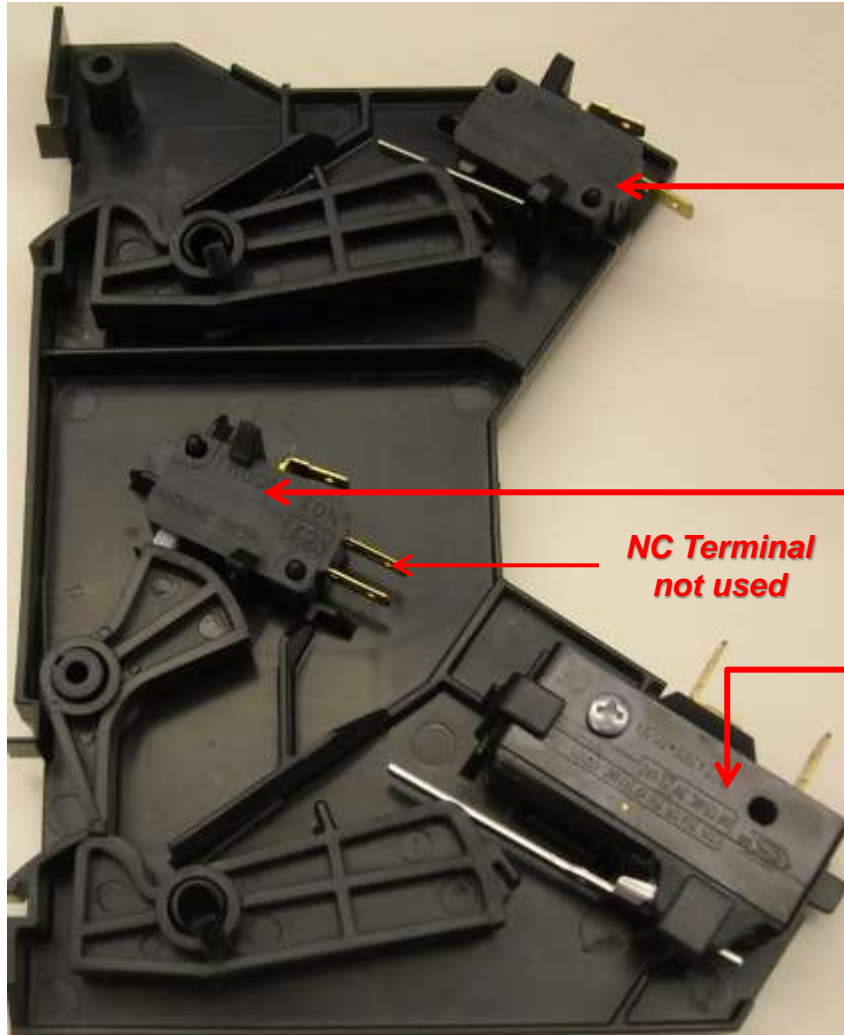

PRIMARY INTERLOCK SWITCH
Open-Infinite Ω with Door Open
Closed-Continuity 0 Ω with Door Closed

MONITOR INTERLOCK SWITCH
Open-Infinite Ω with Door Open
Closed-Continuity 0 Ω with Door Closed

*NC Terminal
not used*

SECONDARY INTERLOCK SWITCH
Open-Infinite Ω with Door Open
Closed-Continuity 0 Ω with Door Closed

When replacing door switch assembly move as far forward towards the door as possible before tightening mounting screws. The door should have some play at the latch with the door closed, it will close tighter when the unit is up to operating temperature.

MONITOR RELAY BOARD - REMOVAL



Note: An open main fuse caused by high amperage requires the replacement of the Monitor Relay Board since high current will cause the monitor relay board's contacts to stick.

This is a UL requirement.

Disconnect both wire connectors and remove screw.

Monitor Relay Board and the plastic standoffs come off together.

MONITOR RELAY BOARD - TESTING

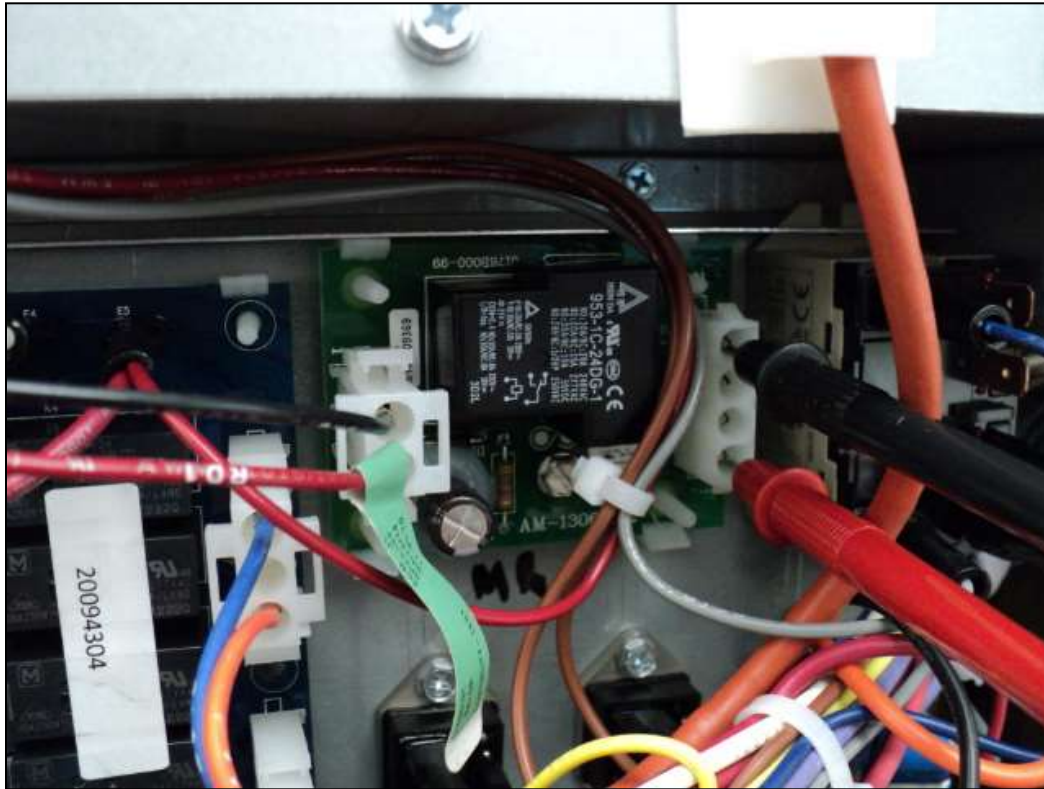

- 1) Unplug Unit
- 2) Disconnect J2 Connector
Test leads at J2-1 to J2-4
and check for Continuity
 0Ω as shown.
- 3) Plug Unit In
- 4) J2-1 to J2-4 should now
read Open/Infinite Ω

**ALWAYS USE CAUTION WHEN
MAKING LIVE VOLTAGE TESTS**



POWER RELAY-ACCESS/REMOVAL

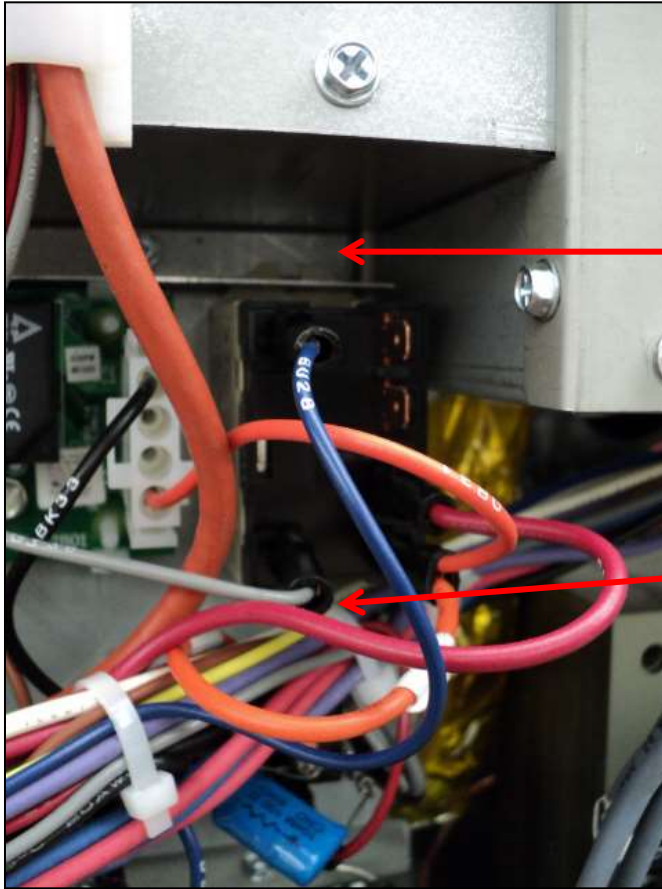

Relay is tabbed into mounting bracket

Remove wiring and securing screw at bottom of relay

POWER RELAY- TESTING

PURPOSE of POWER RELAY:

When powered, the Power Relay provides Line 2 through the Triac to the common terminal of the High Voltage Transformer.

OPERATION OF POWER RELAY:

Line voltage is supplied across terminals 0 & 1 via the Secondary Interlock Switch, Magnetron Thermal Cutouts, Oven Thermal Cutout, Fuse, & Control Board J1-1 to J2-3.

RESISTANCE TESTING:

0 to 1 = 6M ohms to 7M ohms (diode in circuit)

2 to 4 = Open (not used)

6 to 8 = Open

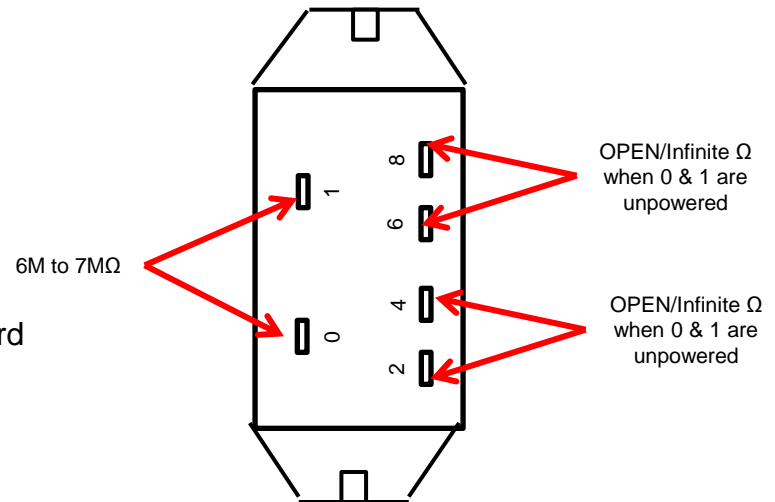

RTD (TEMPERATURE SENSOR) - TESTING/REMOVAL

THE RTD (resistive thermal device) is the temperature sensor for the unit. Its resistance value increases as temperature increases

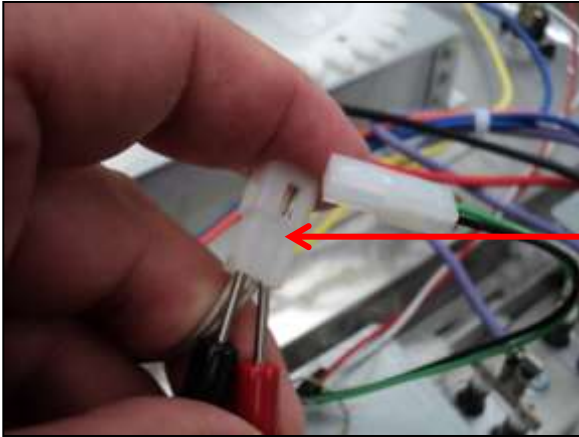

Unplug wire connector measure across terminals
APPROX. 1100 Ω at room temperature
APPROX. 1650 Ω at 350°F / 177 C

To Remove: Remove securing nut and bolt (inside cavity) and remove the sensor from the cavity top.



THERMAL CUTOUTS (TCO) - TOP

CAVITY THERMAL CUTOUT

Connects in a looping circuit to Control Board. Failure (open) causes a "HOT" error code until it resets.

Purpose is to protect against high oven temperatures and no food loads.

SPECIFICATIONS for both TCO's

Open/Infinite Ω at 300° F (149°C)

Closed/0 Ω at 257° F (125° C)

Ohm/Resistance Test

Terminal to Terminal with at least one wire disconnected and below 300° F (149° C) = Closed/0 Ω

TOP CAVITY THERMAL CUTOUT

In series with Oven Thermal Cutout and in circuit that provides line voltage to Control Board. Failure (open) causes a "dead" unit symptom. Purpose is to protect against high oven temperatures and no food loads.

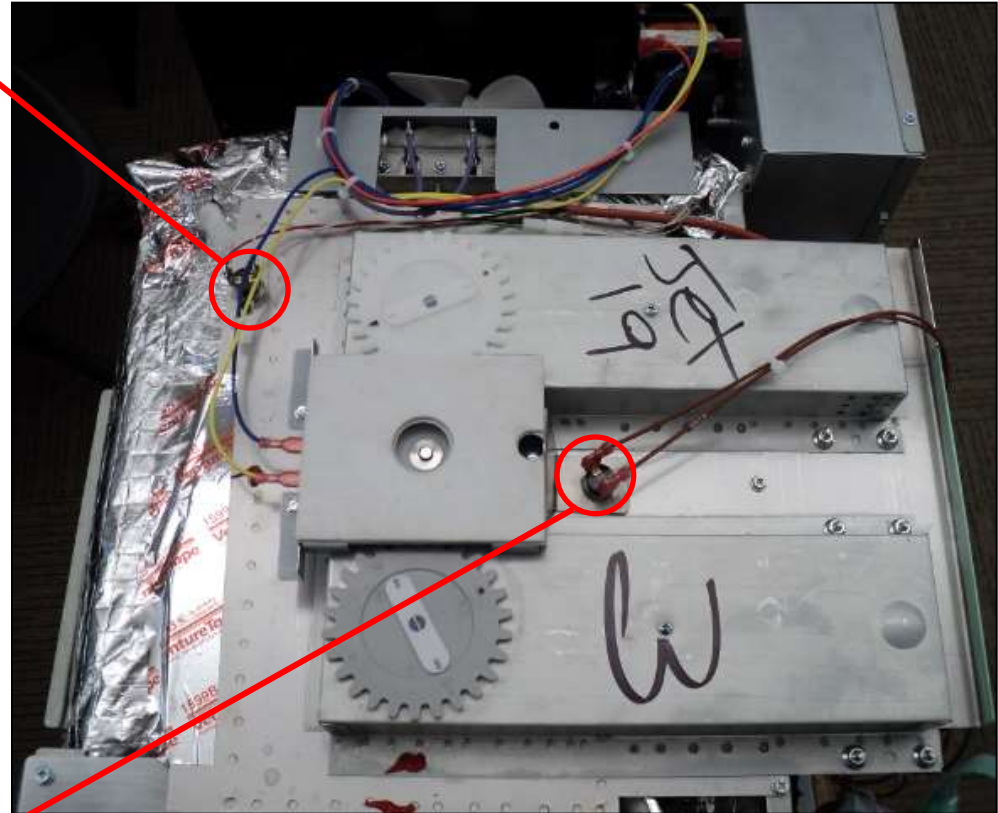

TCO Part #31866P01

THERMAL CUTOUTS (TCO) – RIGHT SIDE

Mag TCO part# [B5684130](#)

SPECIFICATIONS

Open-Infinite Ω at 300° F (149° C)
Closed-0 Ω at 257° F (125° C)

Ohm/Resistance Test

Terminal to Terminal with at least one wire disconnected and below 300° F (149° C) = Closed-0 Ω

Magnetron Thermal Cutouts are in series and in the circuit that provides line voltage to the Power Relay. Failure (open) creates a no cook symptom. Reasons for failure vary, but are usually due to poor cooling of magnetrons (air flow issue) or no/light food load conditions.

FRONT
MAGNETRON
THERMAL CUTOUT

REAR
MAGNETRON
THERMAL CUTOUT



THERMAL CUTOUT (TCO) – LEFT SIDE

OVEN THERMAL CUTOUT

In series with Top Cavity Thermal Cutout and in circuit that provides line voltage to Control Board. Failure (open) causes a “dead” unit symptom. This Thermal Cutout does NOT reset. Purpose is to protect against extreme oven temperatures and render the oven as non-usable until causes are corrected

SPECIFICATIONS

Open/Infinite Ω at 350° F (177° C)

Ohm/Resistance Test

Terminal to Terminal with at least one wire disconnected and below 350° F (177° C) = Closed/0 Ω



OVEN / CAVITY TCO part # [B5684123](#)

NOTE: When replacing, ensure insulation is properly in place between the cutout and the oven cavity.

NEW THERMAL CUTOUT (TCO) – BOTTOM LEFT SIDE

OVEN THERMAL CUTOUT

In series with Top Cavity Thermal Cutout and in circuit that provides line voltage to Control Board. Failure (open) causes a “dead” unit symptom. This Thermal Cutout DOES reset. Purpose is to protect against extreme oven temperatures and render the oven as non-usable until the unit cools down and resets



Replace existing 177C TCO with 350C Resettable TCO

SPECIFICATIONS

Opens at 662° F (350° C) +/-18°
Closes at 482° F (250° C) +/-20°

OVEN / CAVITY TCO part # [14159097](#)

Ohm/Resistance Test

Terminal to Terminal with at least one wire disconnected = Closed/0Ω

NOTE: When replacing, ensure insulation is properly in place between the cutout and the oven cavity.

TRIACS – RESISTANCE TESTING

CONVECTION
MOTOR TRIAC

HEATER TRIAC

MAGNETRON TRIAC

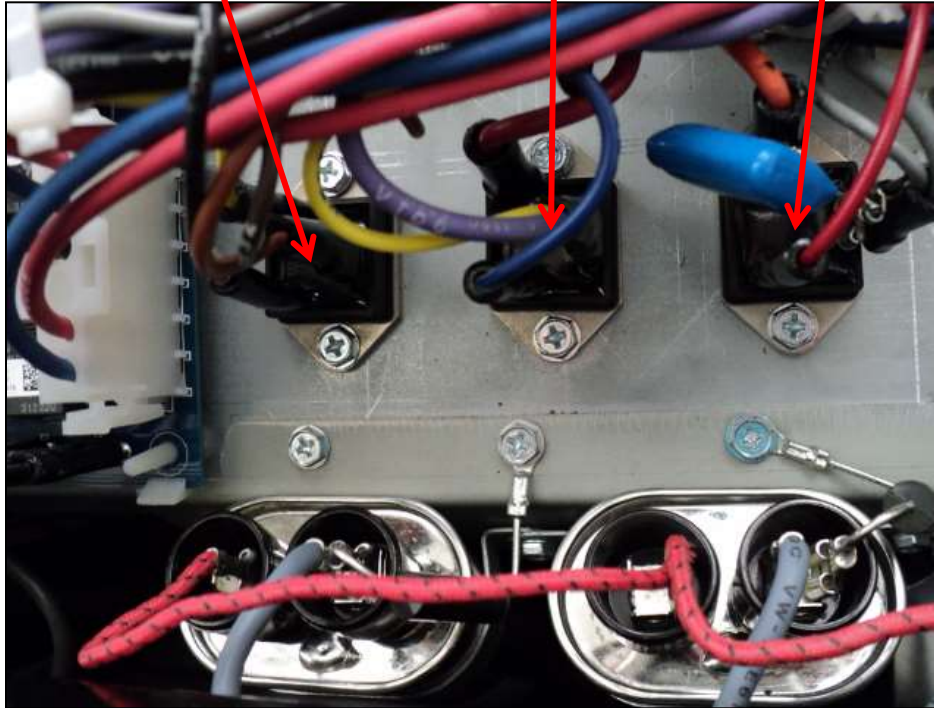

Triac = A three electrode semiconductor device that will conduct in either direction when triggered by a positive or negative signal at the gate electrode

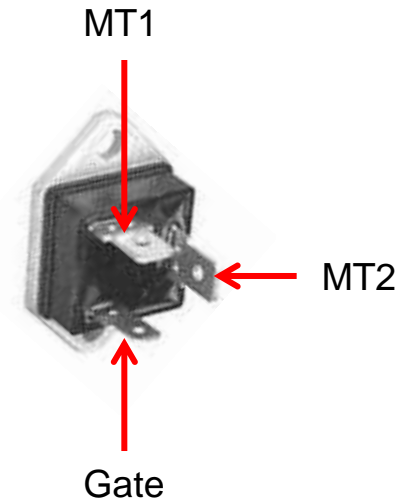

Ohm/Resistance Test

- MT1 to MT2 - Open-Infinite Ω
- MT1 to Gate - Approximately 60 Ω
- MT2 to Gate - Open-Infinite Ω
- All to Ground - Open-Infinite Ω

TRIACS – VOLTAGE TESTING

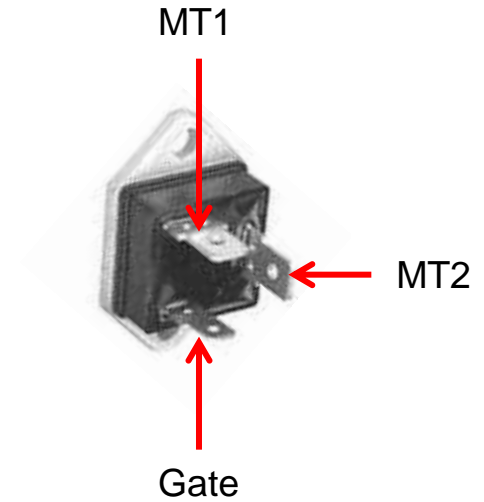

**ALWAYS USE CAUTION WHEN
MAKING LIVE VOLTAGE TESTS**

Voltage Testing with Component On

MT1 to MT2 - 0vac. If line voltage is read,
Triac is open so check gate voltage/signal
MT1 to Gate - Approx. 0.8vac. No voltage
Indicates no signal from control board.



CAPACITORS & DIODES- ACCESS/REMOVAL

Slide assembly out

REMOVE THREE
BRACKET SCREWS

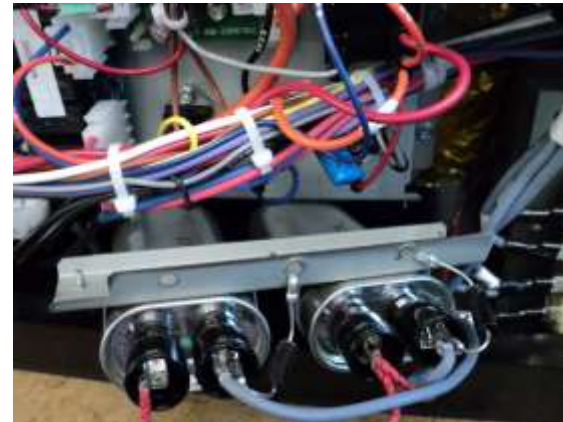
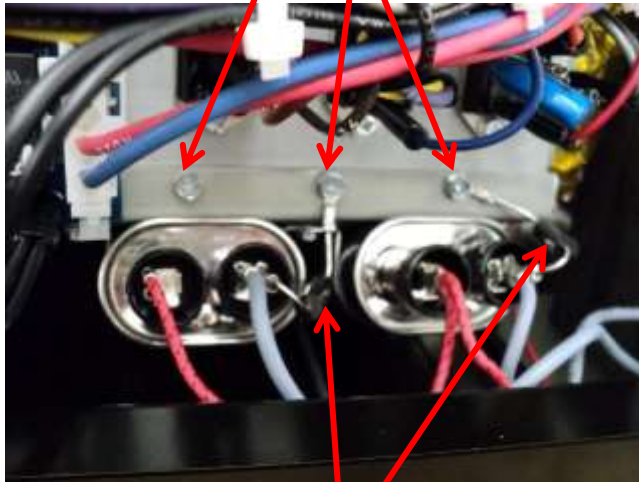

DIODES - RIGHT TWO BRACKET SCREWS



NEVER TEST HIGH VOLTAGE CARRYING
COMPONENTS WITH UNIT POWERED
AND ALWAYS DISCHARGE CAPACITORS
BEFORE TESTING COMPONENTS.





DIODE TESTING 1



ALWAYS DISCHARGE CAPACITOR BEFORE HANDLING!

MANY VOLT/OHM METERS (DIGITAL OR ANALOG) IN USE TODAY CANNOT READ THE VERY HIGH RESISTANCE ACROSS THE DIODE. METER NEEDS A MINIMUM OF 6 VOLTS OUTPUT ON OHMS SCALE. FOR METERS CAPABLE, RUN THE FOLLOWING TEST.

REMOVE DIODE LEAD FROM CAPACITOR AND CONNECT OHMMETER. DIODE SHOULD READ INFINITE OHMS IN ONE DIRECTION AND GREATER THAN 50,000 OHMS IN THE OPPOSITE DIRECTION (METER LEADS REVERSED)



DIODE COMPLETELY REMOVED FOR ILLUSTRATION PURPOSES



DIODE TESTING 2



ALWAYS DISCHARGE CAPACITOR BEFORE HANDLING!

MANY VOLT/OHM METERS (DIGITAL OR ANALOG) IN USE TODAY CANNOT READ THE VERY HIGH RESISTANCE ACROSS THE DIODE. METER NEEDS A MINIMUM OF 6 VOLTS OUTPUT ON OHMS SCALE. THE RESULT IS MANY DIODES ARE IMPROPERLY DIAGNOSED. IF THE METER BEING USED DOES NOT HAVE THE REQUIRED VOLTAGE, A 9VDC BATTERY CAN BE USED TO ASSIST IN PROPER DIAGNOSIS.

METER SET TO READ DC VOLTS – 9VDC Minimum

CONNECT THE POSITIVE TERMINAL OF THE BATTERY TO THE SPADE TERMINAL OF THE DIODE AND THE NEGATIVE BATTERY TERMINAL TO THE COMMON (BLACK) METER LEAD. CONNECT THE RING TERMINAL OF THE DIODE TO THE RED METER LEAD.



RESULT = 0vdc

REVERSE THE DIODE SO THE RING TERMINAL IS NOW ON THE BATTERY AND THE SPADE TERMINAL IS ATTACHED TO THE RED METER LEAD.



RESULT = Battery Voltage

CAPACITOR TESTING



Capacitance meters are available commercially and are a fast way to help diagnose capacitors. Capacitor values can be obtained by looking at its rating label. Values vary from model to model

0.74
MICROFARAD

2300
VOLTS AC

10M OHM
BLEEDER
RESISTOR

Aerovox®
N50H2374G21A 389652
0.74 uF +/-3% 2300 VAC 50/60Hz
25/85/50 85C 10 MEG-OHM
CLASS P NO PCB'S 1218
MADE IN USA
12730006
IEC 61207

GOOD = .748
OPEN = .000
SHORTED = 1.

HIGH VOLTAGE TRANSFORMER - RESISTANCE TESTING

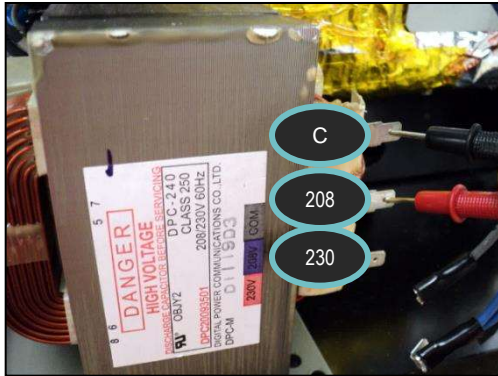

NEVER TEST HIGH VOLTAGE CARRYING COMPONENTS WITH UNIT POWERED AND ALWAYS DISCHARGE CAPACITORS BEFORE TESTING COMPONENTS.

**PRIMARY WINDINGS
COMMON - 208 = $<2\Omega$
COMMON - 230 = $<2\Omega$
OPEN TO GROUND**

**FILAMENT WINDINGS
5-6 & 7-8 LESS THAN 1Ω
OPEN TO GROUND**

**HIGH VOLTAGE SECONDARY
(HV4) APPROX. 28Ω
TO CHASSIS GROUND**

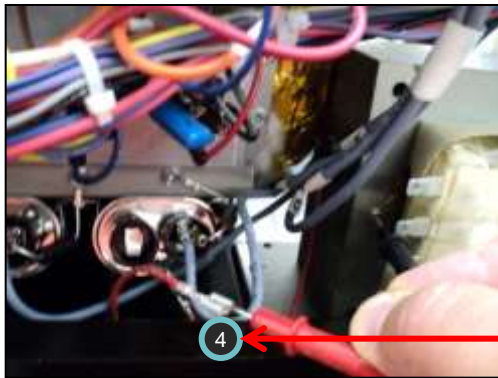
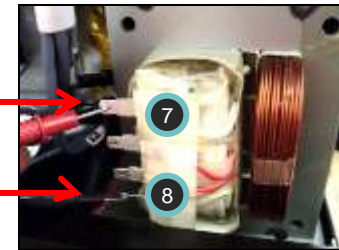
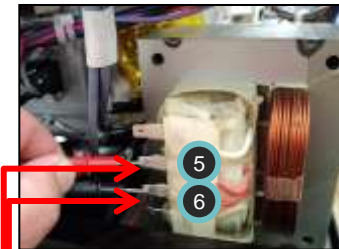

HIGH VOLTAGE TRANSFORMER IS DUAL VOLTAGE RATED. CONTROL BOARD SENSES INCOMING LINE VOLTAGE AND SENDS LINE 1 TO TRANSFORMER

HIGH VOLTAGE TRANSFORMER LINE VOLTAGE ISOLATION TEST

For MW No Heat or Low Heat Condition

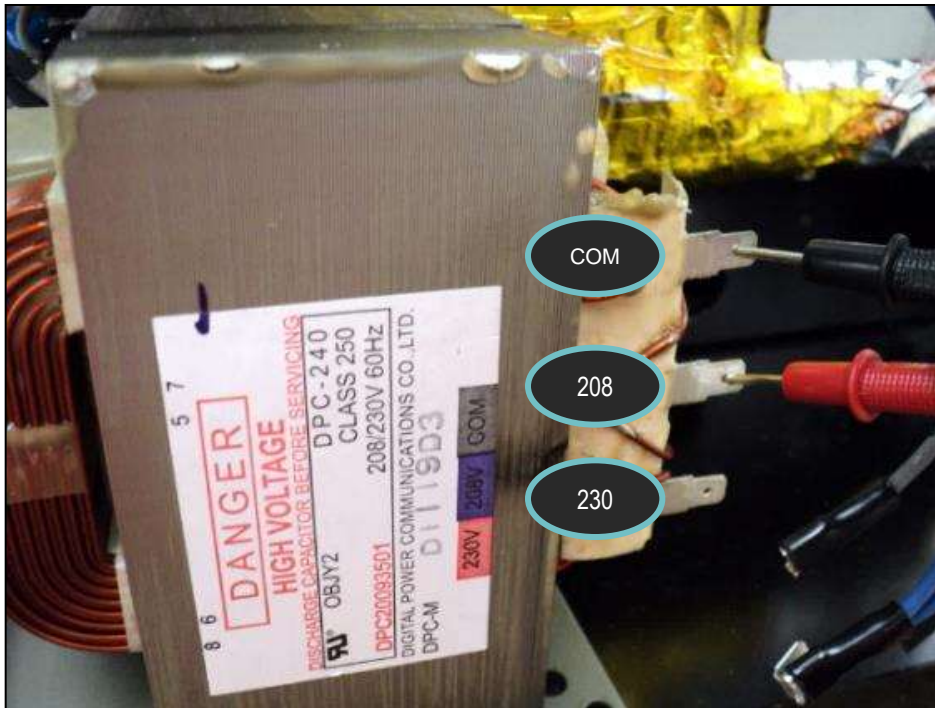

IN A COOK CONDITION

208 Line Voltage, test between Com. & 208 results should be 208 Volts
230 Line Voltage, test between Com. & 230 results should be 230 Volts
If not remove wires and test from each wire to chassis ground - should be 115V.

Com. (L2) through Triac-Power Relay and E1 on HV Board. Also check Door Switch Assembly which powers relay

208 or 230 (L1) through relay on HV Board

HIGH VOLTAGE TRANSFORMER IS DUAL VOLTAGE RATED. CONTROL BOARD SENSES INCOMING LINE VOLTAGE AND SENDS LINE 1 TO TRANSFORMER



NEVER TEST HIGH VOLTAGE CARRYING COMPONENTS WITH UNIT POWERED

HIGH VOLTAGE TRANSFORMER - REMOVAL

- 1) Remove Cabinet and Back Panel
- 2) Remove Transformer wiring (note wire connections)
- 3) Remove securing screw
- 4) Slide Transformer to the right approx. one inch.
- 5) Lift Transformer up and out of securing tab/slot



REMOVE SECURING SCREW

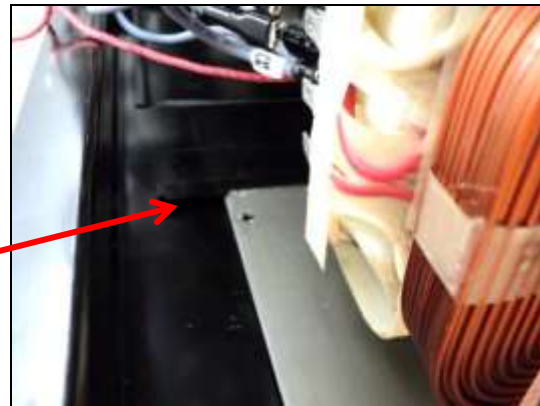

SECURING TAB/SLOT

MAGNETRON - TESTING

Since Magnetron wiring is covered by an air duct, testing can be made at High Voltage Transformer and Capacitor. Note wire locations and disconnect appropriate wires from Capacitor and High Voltage Transformer



Back Magnetron
WIRE 5 to WIRE 6
LESS THAN 1Ω &
Open to Chassis Ground

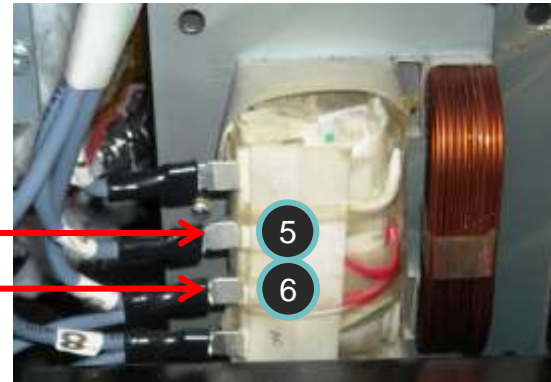

Front Magnetron
WIRE 7 to WIRE 8
LESS THAN 1Ω &
Open to Chassis Ground

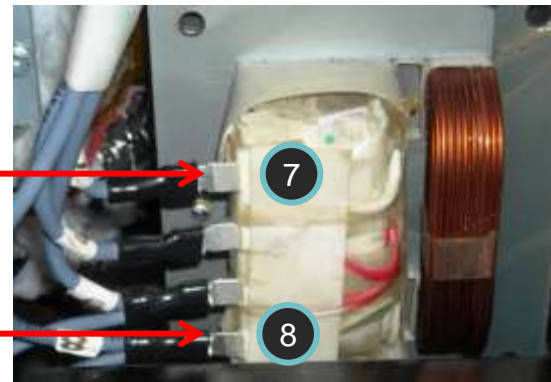

NEVER TEST HIGH VOLTAGE CARRYING COMPONENTS WITH UNIT POWERED AND ALWAYS DISCHARGE CAPACITORS BEFORE TESTING COMPONENTS.

MAGNETRON ACCESS (REAR)

UNCLIP
WIRING
(3 LOCATIONS)

REMOVE COVER

REMOVE TCO
(Thermal Cutout) Wiring

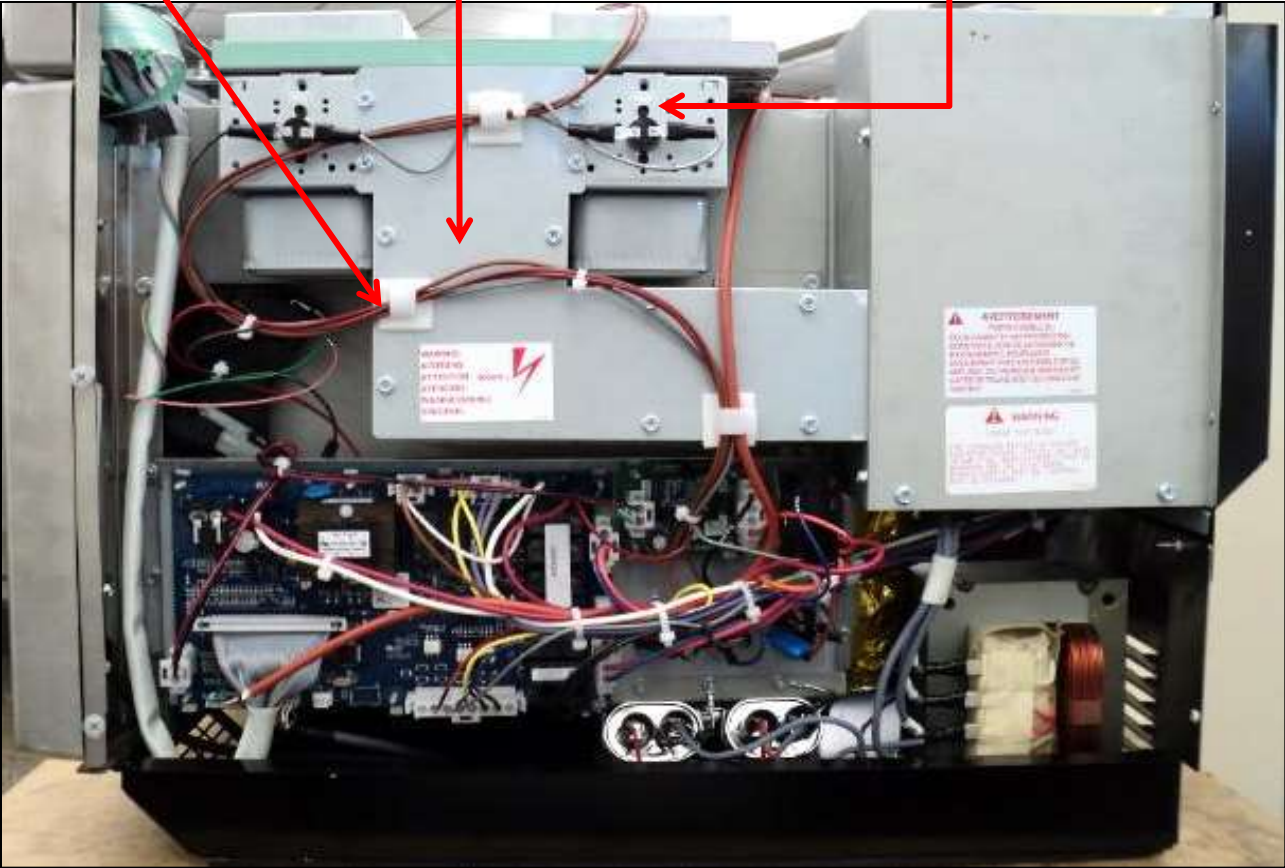

MAGNETRON ACCESS/REMOVAL

DISCHARGE CAPACITORS THEN
REMOVE MAGNETRON WIRING

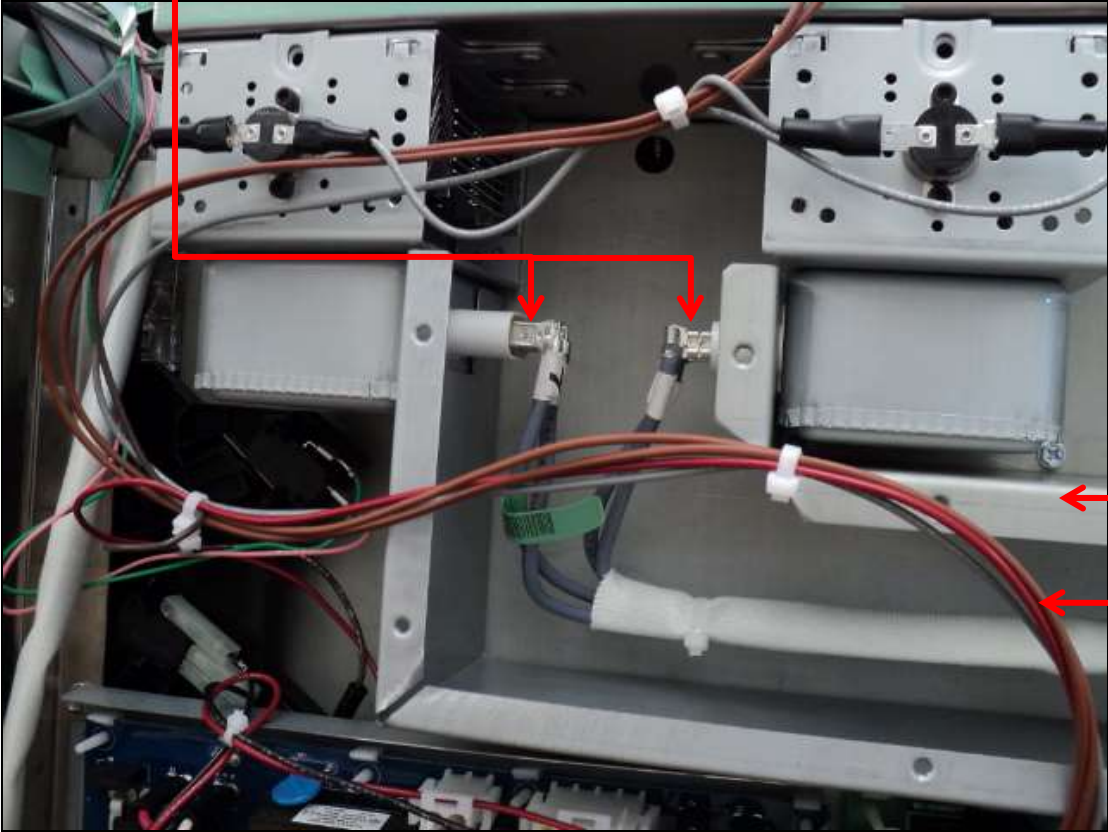

REMOVE BRACKET
SCREW and SWING
BRACKET DOWN

MAGNETRON
WIRING POSITIONED
IN CENTER OF AIR
DUCT

MAGNETRON REMOVAL (REAR) CONT'D

REMOVE 4 - 5/16 NUTS AND DROP
MAGNETRON OUT OF WAVEGUIDE

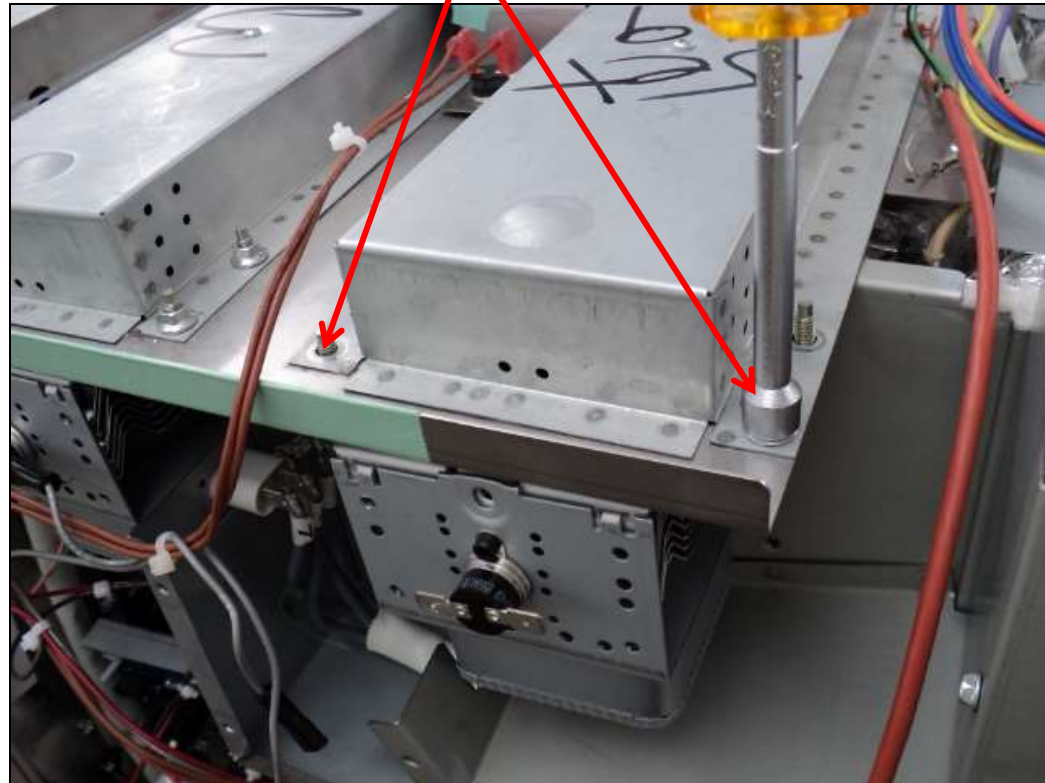

Upon reassembly
always ensure high
voltage wiring is firmly
secured to magnetron
connections

SERVICE TEST MODE

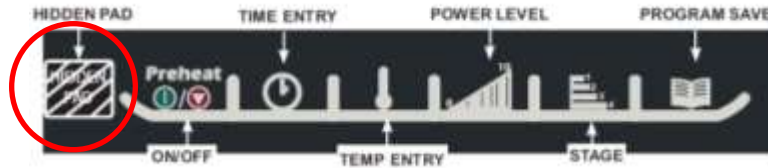

- 1) Open and Close the Door
- 2) In order, press and release the following key pads; Hidden Pad, 1, 3, 5, 7, then 9.
(Note: No keypad beep or display change will occur while pressing keypads)
Display will show “Service Mode” and reflect Hz and Line Voltage sensed.

Once in Service Mode, pressing another keypad will activate a specific test:

KEYPAD	RESULT
Time Entry	208, 230, or Automatic Voltage Sensing
Temp Entry	Cavity Temperature as sensed by Temperature Sensor (RTD)
1	Calrod (Heater) On. Pressing again shuts off - NOTE: Amp reading innaccurate
2	n/a
3	Magnetron On. Pressing again shuts off
4	Convection Motor. Pressing again shuts off - NOTE: Amp reading innaccurate
5	Cooling Fan Motor. Pressing again shuts off
6	n/a
7	Magnetron Hours
8	Door Cycle Count
9	Clear Service Information - Magnetron Hours and Door Cycles
0	Temperature Offset - Press 0 to change. Range is -40 to +40
Stop/Reset	Exit Service Mode

USER OPTIONS

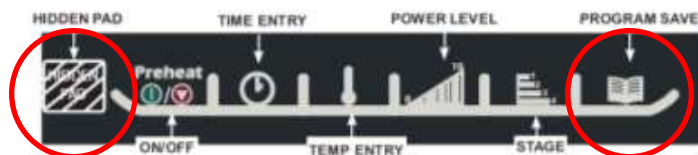

- 1) Open and close the door.
- 2) Press and release the Hidden Pad, then quickly press and release Program Save.
- 3) Press desired numeric key pad for specific option.
- 4) To change an option, press numeric pad again.
- 5) To Save a change, press the Program Save pad. To exit, press Stop/Reset or open and close the door.

Numbered Pads	Display	Options (Factory Settings in Bold)
1 Double Digit Entry	Disabled Enabled	Allows 10 (0-9) preprogrammed pads. Allows 100 (00-99) preprogrammed pads.
2 Manual Time Entry	Disabled Enabled	Manual time entry/cooking not allowed. Manual time entry/cooking allowed.
3 Reset on Door Open	Disabled Enabled	Opening oven door does not reset oven back to ready mode. Opening oven door resets the oven back to ready mode.
4 Keybeep	Keybeep ON Keybeep OFF	Keys beep when pressed (keybeep on). Keys do not beep when pressed (keybeep off).
5 Keybeep Volume	OFF LOW MEDIUM HIGH	Keybeep volume OFF. Keybeep volume LOW. Keybeep volume MEDIUM. Keybeep volume HIGH.
6 End of Cook Signal	Solid Beep 3 Second Beep 4 Beeps Once 4 Beeps Repeating	Food done signal is a continuous beep until reset by user. Food done signal is a three second beep. Food done signal is four beeps, continuously. Food done signal is four beeps, four times.
7 Keypad Active	15 SECONDS 30 SECONDS 60 SECONDS 120 SECONDS ALWAYS	Keypad time entry window is 15 seconds. Keypad time entry window is 30 seconds. Keypad time entry window is one minute. Keypad time entry window is two minutes. Keypad time entry window is always active.
8 Preheat Warnings	Disabled Program Warning Only Preheat Warning Only Both	Both temperature warnings off. Warning only when preheat temperature does not match preprogrammed temperature. Warning only when actual oven cavity temperature is not to preheat temperature. Both temperature warnings on.
TEMP PAD Temperature Scale	FAHRENHEIT CELSIUS	Temperatures are displayed in °F for 60 Hz models. Temperatures are displayed in °C for 50 Hz models.
STAGE PAD CLEAN FILTER Message Frequency	Disabled Weekly Monthly Quarterly	Oven will not display Clean Filter. Oven will display Clean Filter every seven (7) days. Oven will display Clean Filter every thirty (30) days. Oven will display Clean Filter every ninety (90) days.
POWER LEVEL PAD MICROWAVE ONLY	Disabled Enabled	Oven will not operate in microwave only mode. Oven will operate in microwave only mode.

Test equipment required:

- 1000 ml test container and thermometer.

Procedure

1. Fill the test container to the 1000 ml line with cool tap water as close to 60° F / 16° C as possible.
2. Using the thermometer, stir water for ten seconds; measure, and record the temperature.
3. Place test container of water in the center of oven cavity and close door.
4. Heat the water for a 33-second full power cycle.
5. At end of the cycle, remove test container. Using the thermometer, stir water for ten seconds and record temperature.
6. Subtract the starting water temperature from the ending water temperature to obtain the temperature rise.
7. If the temperature rise meets or exceeds the minimum, the test is complete. If the temperature rise fails to meet the minimum temperature rise, test the line voltage to verify it is correct. Then repeat steps 1-6 making sure to change the water. If the temperature rise fails to meet the minimum temperature rise again the oven will require service.

**MICROWAVE
POWER TEST**

Minimum Temperature Rise at Thirty -Three (33) Seconds Run Time

Rise (°F)	Cooking Power Output	Rise (°C)	Cooking Power Output
14°F	1400	7.5°C	1400
19°F	1900	10.5°C	1900

Important Notes:

- * Convection ovens must be at room temperature and set for microwave only (or use Service Test Mode) for best results.
- * Low line voltage will cause low temperature rise / power output.
- * Ovens must be on a dedicated circuit, properly grounded, and polarized. Other equipment on the same circuit may cause a low temperature rise / power output.
- * This test and results are not a true IEC705 test procedure and are only intended to provide servicers with an easy means of determining if the microwave oven cooking output is correct.

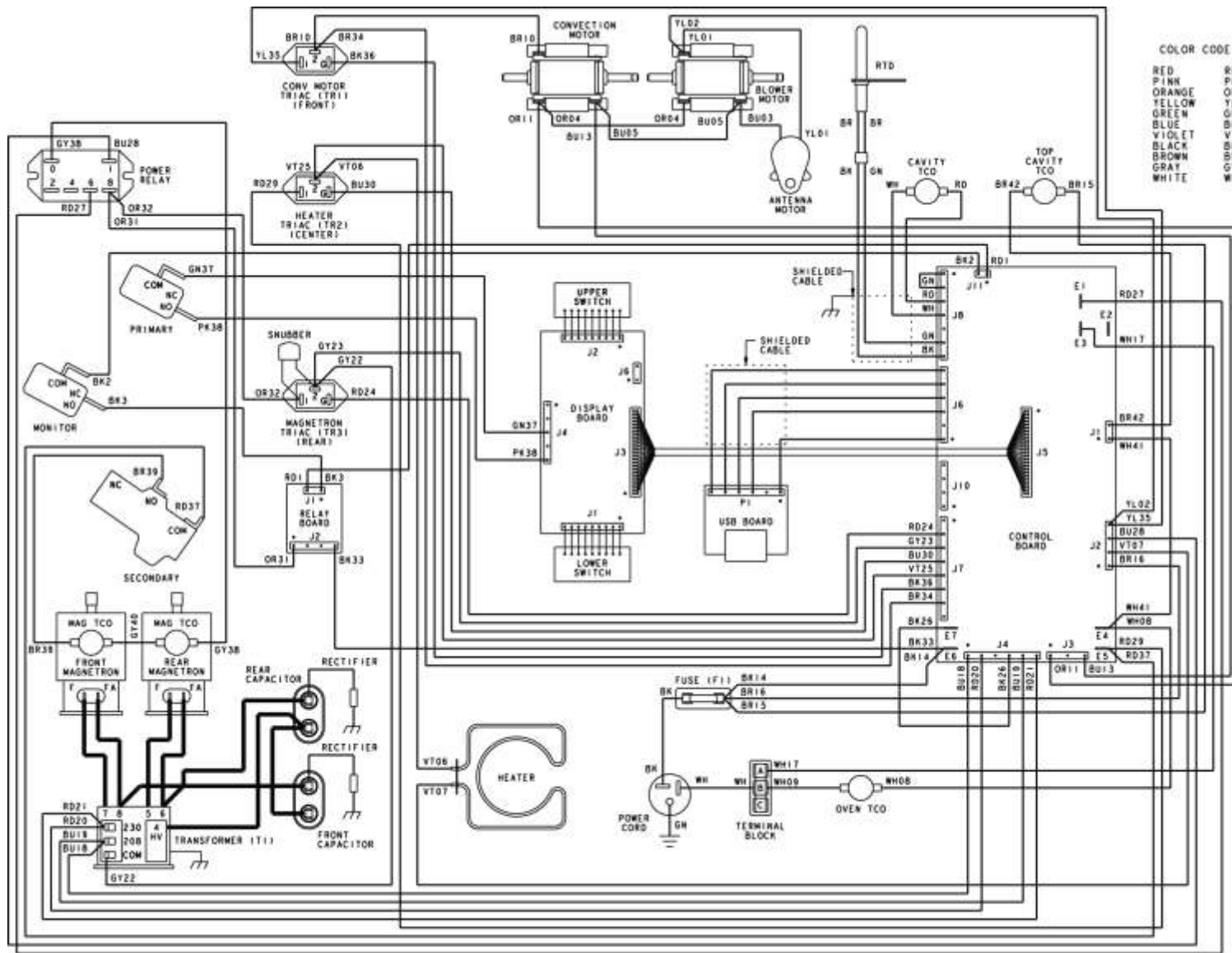

**WIRING
DIAGRAM**

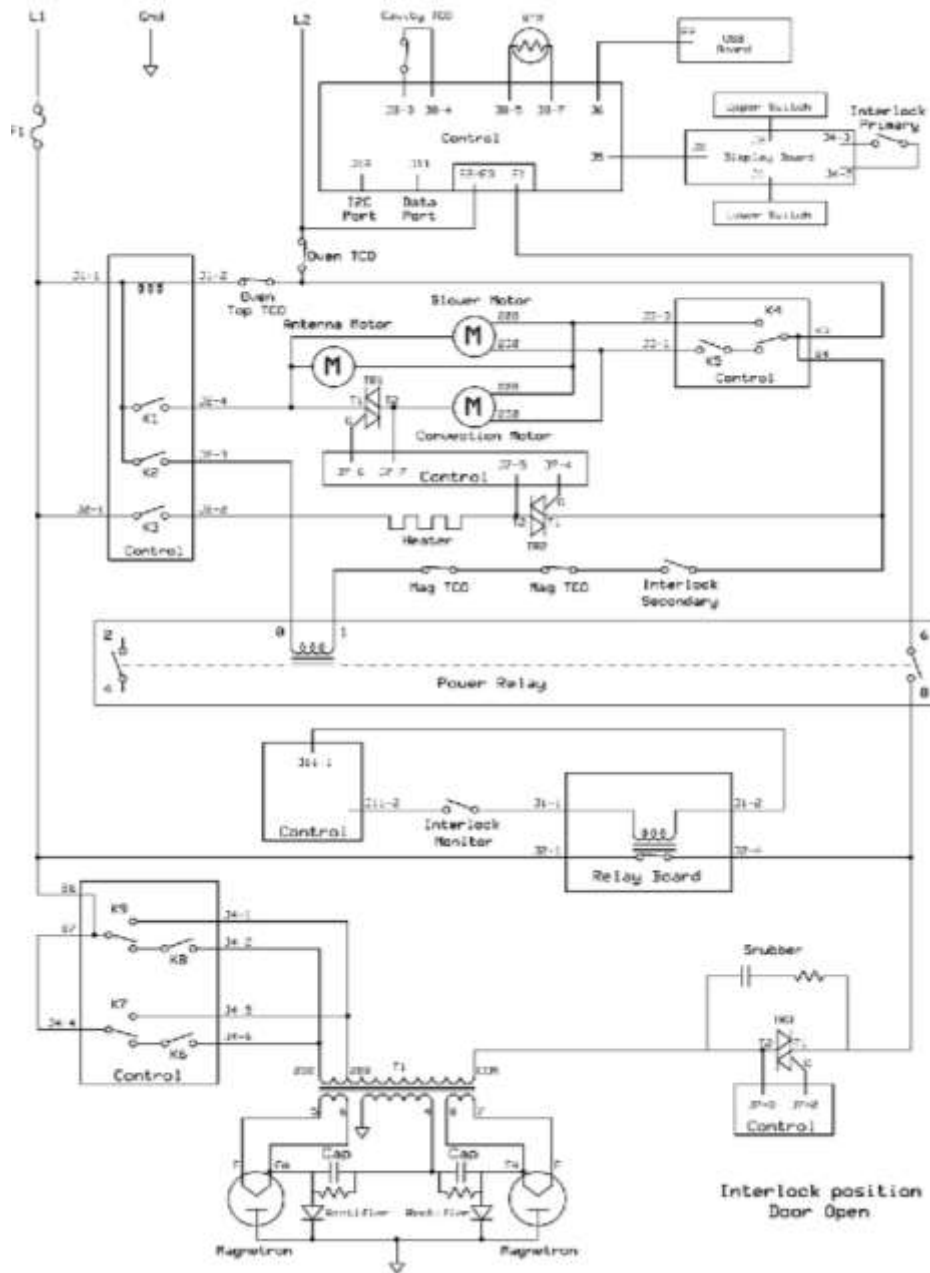

WIRING SCHEMATIC