

# Service Manual

HIGH SPEED COMMERCIAL COMBINATION OVEN

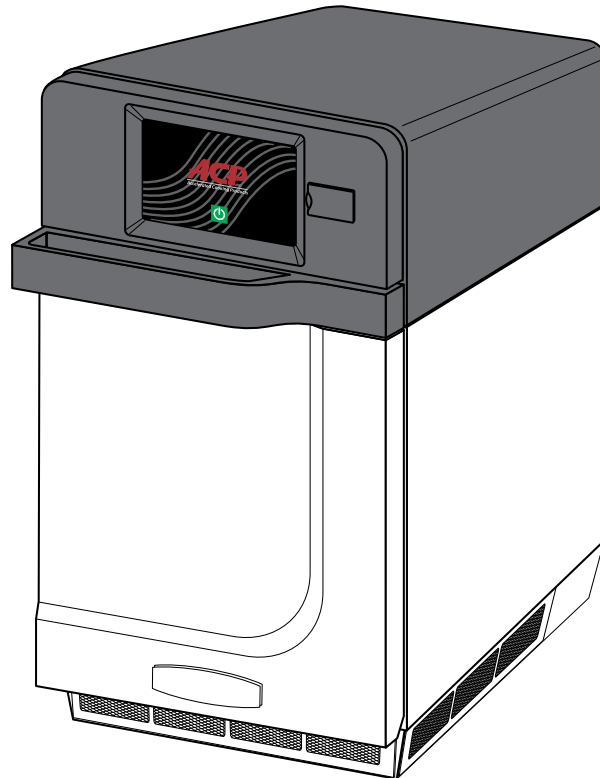

**Models Covered:** ARX1, ARX1BL, ARX2, ARX2BL  
MRX1, MRX1BL, MRX2, MRX2BL

Keep these instructions for future reference.

Please read this manual thoroughly before attempting to install, operate or service this equipment.

Prior to servicing this equipment, please refer to the **SAFETY INSTRUCTIONS** contained in this manual for important safety information.

# Table of Contents

Model Identification.....	5
Online Oven Resources.....	5
ACP Programming Application.....	5
Firmware Updates.....	5
Important Safety Instructions.....	7
General Safety Instructions.....	9
Theory of Operation.....	12
Sequence of Operation.....	12
Specifications.....	14
Grounding and Installation.....	15
Grounding/Earthing Instructions.....	15
External Equipotential Earthing Terminal (export only).....	15
Installation.....	15
Unpack Oven.....	15
Place Oven on Counter.....	15
Install Cook Plate.....	15
Oven Clearances.....	15
Touch Panel Menu Descriptions.....	17
Touch Screen Icon Descriptions.....	18
Basic Oven Operation.....	19
Power On Oven, Preheat.....	19
Power Off Oven.....	19
Methods of Cooking and Programming.....	19
First Time Use.....	19
Set User Options.....	19
Preprogrammed Menu.....	20
Cooking with Preprogrammed Menu Items.....	20
Manual Cooking.....	21
Manual Programming.....	23
Save a Menu Item from Manual Cook:.....	23
Manually Edit an Existing Menu Item:.....	23
Manually Move Recipe:.....	23
Manual Organization: Folders.....	24
Manual Organization: Tabs.....	25
Oven Programming: USB Flash Drive.....	26
Export Menu via USB Flash Drive.....	26
Open Menu in ACP Programming Application.....	26
Import Menu via USB Flash Drive.....	26
Oven Programming: Wi-Fi and Ethernet.....	27
Connect Oven to Network.....	27
To connect via Wi-Fi.....	27
To connect via Ethernet.....	27
Connect Computer to Oven via Wi-Fi/Ethernet.....	27
Transfer Recipe Information via Wi-Fi/Ethernet.....	27
Log-in Information.....	27
Care and Cleaning.....	29
Recommended Cleaning Supplies.....	29
For a new oven, before using it for the first time.....	29
Daily Cleaning.....	30
Weekly Cleaning.....	30
User Options.....	32
Access and Modify User Options.....	32
Default User Options.....	33
Firmware Update Procedure.....	35
Before Calling for Service.....	38
Service Test Mode.....	39
With the PIN Code enabled.....	39

# Table of Contents (continued)

With the PIN Code not enabled .....	39
Oven Tests.....	42
Power Test .....	42
Set Up: .....	42
Equipment .....	42
Procedure.....	42
Microwave Leak Test .....	43
Measuring Procedure.....	44
Error Codes .....	45
Troubleshooting Chart .....	46
Panel Removal .....	48
Top Panel.....	48
Side Panels.....	48
Rear Panel.....	48
Removal and Replacement.....	49
Rear Exhaust Duct Removal .....	49
Oven Thermal Cutout (TCO) .....	50
Testing.....	50
Removal and Replacement.....	50
Triacs .....	51
Testing.....	51
Removal and Replacement.....	51
Autotransformer and Snubber .....	52
Testing.....	52
Autotransformer .....	52
Snubber.....	52
Removal and Replacement.....	52
Cooling Fan Relay (24V) .....	53
Testing.....	53
Removal and Replacement .....	53
Power Relay .....	54
Testing.....	54
Removal and Replacement.....	54
HV Capacitor .....	55
Testing.....	55
Removal and Replacement.....	55
HV Diode .....	56
Testing.....	56
Removal and Replacement.....	56
Magnetron TCO.....	57
Testing.....	57
Removal and Replacement.....	57
Magnetron .....	58
Testing.....	58
Removal and Replacement.....	58
Stirrer (Antenna) Motor.....	59
Testing.....	59
Removal and Replacement.....	59
Wave Guide.....	60
Removal and Replacement.....	60
HV Transformer .....	61
Testing.....	61
Removal and Replacement.....	61
Primary Interlock Switch .....	62
Testing.....	62
Removal and Replacement.....	62

# Table of Contents (continued)

Secondary, Monitor and Tertiary Interlock Switches .....	63
Testing.....	63
Removal and Replacement.....	63
For Secondary and Monitor Switches .....	63
For Tertiary Switch.....	63
Power Supply Board.....	64
Testing.....	64
Removal and Replacement.....	64
Main Control Board.....	65
Testing.....	65
Removal and Replacement.....	65
Touch Screen Display Board .....	66
Testing.....	66
Removal and Replacement.....	66
Temperature Sensor .....	67
Testing.....	67
Removal and Replacement.....	67
Convection Motor .....	68
Testing.....	68
Removal and Replacement.....	68
Heater .....	69
Heater .....	69
Testing.....	69
Removal and Replacement.....	69
Cooling Fans .....	70
Testing.....	70
Removal and Replacement.....	70
Cooling Fan Motor Run Capacitors .....	71
Testing.....	71
Removal and Replacement.....	71
Wiring Diagrams & Schematics .....	73
Electrical Schematic: Models Amx1, Amx1bl, Mrx1, Mrx1bl.....	73
Wiring Diagram: Models Amx2, Amx2bl, Mrx2, Mrx2bl .....	74
Electrical Schematic: Models Amx2, Amx2bl, Mrx2, Mrx2bl.....	75
Wiring Diagram: Models Amx2, Amx2bl, Mrx2, Mrx2bl .....	76

# Model Identification

When contacting ACP, provide product information. Product information is located on oven serial plate. Record the following information:

Model Number: \_\_\_\_\_

Serial or S/N Number: \_\_\_\_\_

Date of installation: \_\_\_\_\_

Dealer's name and address: \_\_\_\_\_

\_\_\_\_\_

\_\_\_\_\_

Any questions or to locate an authorized ACP servicer, call ACP ComServ Service Support.

– **Inside** the U.S.A. or Canada, call toll-free at 866-426-2621.

– **Outside** the U.S.A. and Canada, call 319-368-8195.

– **Email:** [commercialservice@acpsolutions.com](mailto:commercialservice@acpsolutions.com)

Warranty service must be performed by an authorized ACP servicer. ACP also recommends contacting an authorized ACP servicer, or ACP ComServ Service Support if service is required after warranty expires.

Before servicing this oven, please take the time to read the Safety Instructions contained in this manual.

Information herein is subject to change without notice. Errors are subject to correction.

For the most recent product literature, please visit [acpsolutions.com/product-literature/](http://acpsolutions.com/product-literature/)

## Online Oven Resources

### ACP Programming Application



Download and install the ACP Programming Application to create, edit, and customize menu and display settings for your oven, using a desktop computer or tablet.

To download the latest and greatest version of the ACP Programming Application please visit [acpsolutions.com/oven-programming/](http://acpsolutions.com/oven-programming/)

### Firmware Updates



For the optimal user experience, ACP recommends using the latest version of oven firmware.

To download firmware updates and installation instructions, or to opt-in for email update notifications, please visit [acpsolutions.com/oven-programming/](http://acpsolutions.com/oven-programming/)

---

# **1 | Important Safety Information**

# IMPORTANT SAFETY INSTRUCTIONS

 **RECOGNIZE THIS SYMBOL AS A SAFETY MESSAGE**

## **WARNING**

When operating this oven, you must follow safety precautions to reduce the risk of personal injury due to burns, electric shock or possible exposure to microwave energy.

## **Important Notice for Servicers and Consumers**

ACP will not be responsible for personal injury or property damage from improper service procedures. Pride and workmanship go into every product to provide our customers with quality products. It is possible, however, that during its lifetime a product may require service. Products should be serviced only by a qualified service technician who is familiar with the safety procedures required in the repair of this equipment and who is equipped with the proper tools, parts, testing instruments and the appropriate service information.

IT IS THE TECHNICIANS RESPONSIBILITY TO REVIEW ALL APPROPRIATE SERVICE INFORMATION BEFORE BEGINNING REPAIRS.

## **WARNING**

To avoid risk of severe personal injury or death, disconnect power before working/servicing on appliance to avoid electrical shock.

## **Recognize Safety Symbols, Words, and Labels**

 **DANGER**

Immediate hazards which **WILL** result in severe personal injury or death.

 **WARNING**

Hazards or unsafe practices which **COULD** result in severe personal injury or death.

 **CAUTION**

Hazards or unsafe practices which **COULD** result in minor personal injury, product or property damage.

### **ComServ Support Center**

**Web Site:** [www.acpsolutions.com](http://www.acpsolutions.com)

**E-Mail:** [commercialservice@acpsolutions.com](mailto:commercialservice@acpsolutions.com)

**Telephone:** 1-866-426-2621 or 319-368-8195

**Amana® Commercial  
ARX Contact:**



**866-426-2621**

**MenuMaster® MRX  
Contact:**



**866-811-8559**

# IMPORTANT SAFETY INSTRUCTIONS

 **RECOGNIZE THIS SYMBOL AS A SAFETY MESSAGE**

## **WARNING**

Read the following information to avoid possible exposure to microwave radiation:

The basic design of the microwave oven makes it an inherently safe device to both use and service.

However, there are some precautions which should be followed when servicing the microwave to maintain this safety. These are as follows:

1. **ALWAYS** operate the oven from an adequately grounded outlet. Do not operate on a two-wire extension cord.
2. Before servicing the oven (if oven is operable) perform the microwave leakage test.
3. The oven should **NEVER** be operated if the door does not properly seat against the seal; the hinges or hinge bearings are damaged or broken; the choke is damaged, (pieces missing, etc.); or any other visible damage can be noted. Check the choke area to ensure that this area is clean and free of all foreign matter.
4. If the oven operates with the door open and produces microwave energy, take the following steps:
  - Tell the user not to operate the oven.
  - Contact ACP ComServ immediately.
5. **ALWAYS** have the oven disconnected when the outer case is removed except when making the "live" tests called for in the Service Manual. **DO NOT** reach into the oven area while the oven is energized. Make all connections for the test and check them for tightness before plugging the cord into the outlet.
6. **ALWAYS** ground the capacitors on the magnetron filter box with an insulated-handle screwdriver before working in the high voltage area of the oven compartment. Some types of failures will leave a charge in these capacitors and the discharge could cause a reflex action which could make you injure yourself.
7. **ALWAYS** remember that in the area of the transformer there is **HIGH VOLTAGE**. When the oven is operating keep this area clear and free of anything which could possibly cause an arc or ground, etc.
8. **DO NOT** for any reason defeat the interlock switches. There is no valid reason for this action at any time; nor will it be condoned by ACP.
9. **IMPORTANT:** Before returning an oven to a customer, be sure to check for proper switch interlock action.
10. The microwave oven should never be operated with any components removed and/or bypassed or when any of the safety interlocks are found to be defective, or when any of the seal surfaces are defective, missing, or damaged.
11. All microwave ovens meet all requirements of the radiation control for Health and Safety Act of 1968. Due to measurement uncertainties, the maximum leakage for the field will be 4mW/cm<sup>2</sup>.
12. To ensure that the oven does not emit excessive microwave leakage and to meet the Department of Health and Human Services guidelines, check the oven for microwave leakage using a microwave oven leakage meter that complies with US Government CDRH / FDA / DHHS requirements and or any other local government requirements. The maximum leakage level allowed by ACP is 4mW/cm<sup>2</sup>.
13. If servicer encounters an emission reading over 4mW/cm<sup>2</sup>, the servicer is to cease repair and contact the ACP ComServ Department immediately for further direction. ACP will contact the proper Government Agency upon verification of the test results.

## SAVE THESE INSTRUCTIONS

# GENERAL SAFETY INSTRUCTIONS

 **RECOGNIZE THIS SYMBOL AS A SAFETY MESSAGE**

## **WARNING**

When using electrical equipment, basic safety precautions should be followed to reduce the risk of burns, electrical shock, fire, or injury to persons including the following:

1. **READ** all instructions before using oven.
2. **READ AND FOLLOW** the specific “**PRECAUTIONS TO AVOID POSSIBLE EXPOSURE TO EXCESSIVE MICROWAVE ENERGY**”.
3. This oven **MUST BE GROUNDED**. Connect only to properly **GROUNDED** outlet. See “**GROUNDING / EARTHING INSTRUCTIONS**”.
4. Install or locate this oven **ONLY** in accordance with the installation instructions in this manual.
5. Liquids or other foods, **MUST NOT BE HEATED** in sealed containers since they are likely to explode.
6. Eggs in their shell and whole hard-boiled eggs **SHOULD NOT BE HEATED** in microwave ovens since they may explode even after microwave heating has ended.
7. Use this oven **ONLY** for its intended use as described in this manual. **DO NOT** use corrosive chemicals or vapors in this oven. This type of oven is specifically designed to heat, cook, or dry food. It is not designed for industrial or laboratory use.
8. This oven is **NOT** intended for use by persons (including children) with reduced physical, sensory or mental capabilities, or lack of experience and knowledge, unless they have been given supervision or instruction concerning use of the appliance by a person responsible for their safety.
9. **CHILDREN SHOULD BE SUPERVISED** to ensure that they **DO NOT** play with the appliance.
10. Failure to maintain the oven in a clean condition could lead to deterioration of the surface that could adversely affect the life of the appliance and possibly result in a hazardous situation.
11. **DO NOT** heat baby bottles in oven. Baby food jars must be open when heated and contents stirred or shaken before consumption in order to avoid burns.
12. **DO NOT** operate this oven if it has a damaged cord or plug, if it is not working properly, or if it has been damaged or dropped.
13. This oven, including power cord, must be serviced **ONLY** by qualified service personnel. Special tools are required to service oven. Contact nearest authorized service facility for examination, repair, or adjustment.
14. **DO NOT** cover or block louvers or other openings on oven.
15. **DO NOT** store this oven outdoors. **DO NOT** use this product near water – for example, near a kitchen sink, in a wet basement, a swimming pool, or a similar location.
16. **DO NOT** immerse cord or plug in water.
17. Keep cord **AWAY** from **HEATED** surfaces.
18. **DO NOT** let cord hang over edge of table or counter.
19. For commercial use only.

## **PRECAUTIONS TO AVOID POSSIBLE EXPOSURE TO EXCESSIVE MICROWAVE ENERGY**

- A. **DO NOT** attempt to operate this oven with the door open since open door operation can result in harmful exposure to microwave energy. It is important not to defeat or tamper with the safety interlocks.
- B. **DO NOT** place any object between the oven front face and the door to allow soil or cleaner residue to accumulate on sealing surfaces.
- C. **DO NOT** operate the oven if it is damaged. It is particularly important that the oven door close properly and that there is no damage to the:
  1. door (bent)
  2. hinges and latches (broken or loosened)
  3. door seals and sealing surfaces.
- D. The oven should not be adjusted or repaired by anyone except properly qualified service personnel.

**SAVE THESE INSTRUCTIONS**

# GENERAL SAFETY INSTRUCTIONS

## RECOGNIZE THIS SYMBOL AS A SAFETY MESSAGE

### WARNING

To avoid risk of fire in the oven cavity:

- a. **DO NOT** overcook food. Carefully attend oven when paper, plastic, or other combustible materials are placed inside the oven, due to the possibility of ignition.
- b. Remove wire twist-ties from paper or plastic bags before placing bag in oven.
- c. If materials inside the oven ignite, keep oven door **CLOSED**, turn oven off and disconnect the power cord, or shut off power at the fuse or circuit breaker panel.
- d. **DO NOT** use the cavity for storage. **DO NOT** leave paper products, cooking utensils, or food in the cavity when not in use.

### WARNING

Liquids such as water, coffee, or tea are able to be overheated beyond the boiling point without appearing to be boiling due to surface tension of the liquid. Visible bubbling or boiling when the container is removed from the microwave oven is not always present. **THIS COULD RESULT IN VERY HOT LIQUIDS SUDDENLY BOILING OVER WHEN A SPOON OR OTHER UTENSIL IS INSERTED INTO THE LIQUID.**

To reduce the risk of injury to persons:

- a. **DO NOT** overheat liquid.
- b. Stir liquid both before and halfway through heating.
- c. **DO NOT** use straight-sided containers with narrow necks.
- d. After heating, allow container to stand in the microwave oven for a short time before removing container.
- e. Use extreme care when inserting a spoon or other utensil into the container.

### CAUTION

To avoid personal injury or property damage, observe the following:

1. **DO NOT** deep fat fry in oven. Fat could overheat and be hazardous to handle.
2. **DO NOT** cook or reheat eggs in shell or with an unbroken yolk using microwave energy. Pressure may build up and erupt. Pierce yolk with fork or knife before cooking.
3. Pierce skin of potatoes, tomatoes, and similar foods before cooking with microwave energy. When skin is pierced, steam escapes evenly.
4. **DO NOT** operate oven without load or food in oven cavity.
5. Microwave popcorn should **NOT** be popped in oven.
6. **DO NOT** use regular cooking thermometers in oven. Most cooking thermometers contain mercury and may cause an electrical arc, malfunction, or damage to oven.
7. **DO NOT** use metal utensils in oven.
8. **DO NOT** use aluminum foil in oven.
9. **NEVER** use paper, plastic, or other combustible materials that are not intended for cooking.
10. When cooking with paper, plastic, or other combustible materials, follow manufacturer's recommendations on product use.
11. **DO NOT** use paper towels which contain nylon or other synthetic fibers. Heated synthetics could melt and cause paper to ignite.
12. **Do not** heat sealed containers or plastic bags in oven. Food or liquid could expand quickly and cause container or bag to break. Pierce or open container or bag before heating.
13. To avoid pacemaker malfunction, consult physician or pacemaker manufacturer about effects of microwave energy on pacemaker.
14. An authorized servicer **MUST** inspect oven annually. Record all inspections and repairs for future use.

## SAVE THESE INSTRUCTIONS

---

# **2** | **Introduction**

- Theory of Operation**
- Sequence of Operation**

# Theory of Operation

---

Utilizing technology that combines Convection and Hot Air-Impingement along with Microwaves, the ARX-MRX family of High Speed Combination Ovens rapidly cook food without sacrificing quality in a small footprint. The controls allow either programmed or manual cooking to coordinate air velocity and microwave production as needed to meet the cooking requirements of the specific product. The on-board catalytic converter allows for ventless installation.

## Sequence of Operation

---

The oven is turned “ON” and allowed to come up to the programmed cooking temperature.

With a Menu Item loaded into the oven cavity and the door closed, the operator can either select from a list of preprogrammed menus or input manual cooking instructions.

There are cooking stages that can have different levels of microwave energy and impingement air velocity.

Once initiated, the oven’s Controller will signal the Magnetron circuit to operate from 0 to 100% by modulating the circuit on and off (or on 100%) based on the program. Simultaneously, the Controller will regulate the Convection Blower’s speed from 0 to 100% based on the program. At the end of each cooking stage, the oven can change to a different microwave level and/or blower speed.

During these cooking stages, the oven controls the cooking temperature by energizing and de-energizing a heating element.

---

# 3

## Specifications

### Power Specification

- Input
- Output
- Consumption

### Oven Dimensions

### Weight

### Grounding

### Installation

# Specifications

MODELS	ARX/MRX 2	ARX/MRX 1
<b>Power Supply</b>		
Voltage AC	208-240 VAC	240 VAC
Amperage	30 A	20 A
Frequency	60 Hz	60 Hz
Single Phase	✓	✓
Plug	NEMA 6-30P	NEMA 6-20P
<b>Power Output</b>		
Microwave	2000 W	1000 W
Convection	3000 W	3000 W
Frequency	2450 MHz	2450 MHz
<b>Power Consumption</b>		
Watts	5950 W	3600 W
Amps @ 240V	28.6 A	18.2 A
<b>Dimensions</b>		
<b>Cabinet</b>		
Width	14 1/8" (358mm)	14 1/8" (358mm)
Height	22 3/4" (578mm)	22 3/4" (578mm)
Depth	29 1/4" (743mm)	29 1/4" (743mm)
<b>Cavity</b>		
Width	12 1/4" (312mm)	12 1/4" (312mm)
Height	7" (178mm)	7" (178mm)
Depth	12 1/4" (312mm)	12 1/4" (312mm)
<b>Weight</b>		
Crated	152 lbs. (69 kg)	134 lbs. (61 kg)
Uncrated	134 lbs. (61 kg)	116 lbs. (53 kg)

# Grounding and Installation

## Grounding/Earthing Instructions



**Oven MUST be grounded.** Grounding reduces risk of electric shock by providing an escape wire for the electric current if an electrical short occurs. This oven is equipped with a cord having a grounding wire with a grounding plug. The plug must be plugged into an outlet that is properly installed and grounded.

Consult a qualified electrician or servicer if grounding instructions are not completely understood, or if doubt exists as to whether the oven is properly grounded.

### Do not use an extension cord.

If the product power cord is too short, have a qualified electrician install a three-slot receptacle. This oven should be plugged into a separate circuit with the electrical rating as provided in the product specifications. When the combination oven is on a circuit with other equipment, an increase in cooking times may be required and fuses can be blown.

### External Equipotential Earthing Terminal (export only)

The oven has a secondary earthing terminal. The terminal provides an external earthing connection used in addition to the earthing prong on plug. Located on outside of oven back, the terminal is marked with symbol shown at right.



## Installation

### STEP 1 - Unpack Oven

- Inspect oven for damage, such as dents in door or inside oven cavity.
- Report any dents or breakage to source of purchase immediately.  
**Do not attempt to use oven if damaged.**
- Remove all packing materials from oven interior.
- If oven has been stored in an extremely cold area, wait a few hours before connecting power.
- If you plan to program via Ethernet, remove plastic plug from port on the right rear of oven. Gently use pliers if necessary.

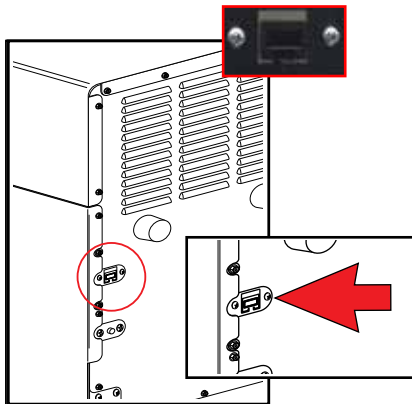

### STEP 2 - Place Oven on Counter

- Recommended countertop surface depth is 28" (71 cm).
- Do not install oven next to or above source of heat, such as pizza oven or deep fat fryer. This could cause oven to operate improperly and could shorten life of electrical parts.
- Do not block or obstruct oven filters. Allow access for cleaning.
- Install oven on level countertop surface.
- Outlet should be located so that plug is accessible when oven is in place.

### STEP 3 - Install Cook Plate

- Install oven cook plate
  - Oven cavity must be cool to touch.
  - Place cook plate in oven with curved edge toward the front of cavity.

**CAUTION: DO NOT cook food directly on floor of oven.**

## WARNING

To avoid risk of electrical shock or death, this oven must be grounded and plug must not be altered.

## WARNING

**Excessive Weight Hazard**  
Use two or more people to move and install oven.  
Failure to do so can result in back or other injury

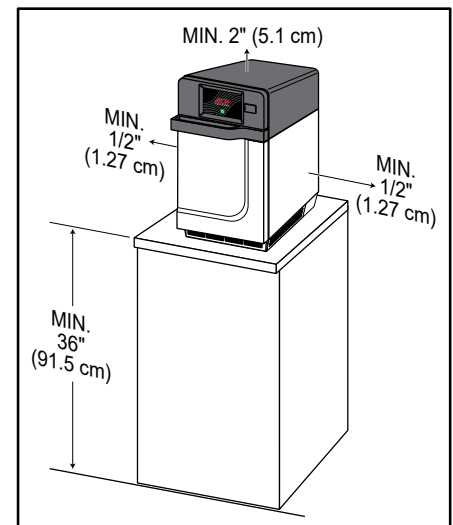

### Oven Clearances

- Allow at least 2" (5.1 cm) of clearance around top of oven. Proper air flow around oven cools electrical components. With restricted air flow, oven may not operate properly and life of electrical parts is reduced.
- There is not an installation clearance requirement for the back of the oven.
- Allow at least 1/2" (1.27 cm) of clearance around sides of oven.
- Install oven so oven bottom is at least 3 feet (91.5 cm) above floor.

---

# 4

## Oven Operation

**Touch Panel Menu Descriptions**











**Touch Screen Icon Descriptions**

**Basic Oven Operation**

















**Preprogrammed Menu**

**Manual Cooking**

# Touch Panel Menu Descriptions

	<p><b>MENU SCREEN</b></p> <ul style="list-style-type: none"> <li>• Scroll up or down to choose from different categories</li> </ul>
	<p><b>CHANGE TEMPERATURE</b></p> <ul style="list-style-type: none"> <li>• Changes current oven temperature</li> </ul>
	<p><b>MANUAL RECIPE</b></p> <ul style="list-style-type: none"> <li>• Manually enter settings for a recipe</li> </ul>
	<p><b>EDIT RECIPE</b></p> <ul style="list-style-type: none"> <li>• Change current oven temperature</li> </ul>
	<p><b>MOVE RECIPE</b></p> <ul style="list-style-type: none"> <li>• Move/reorganize individual programmed recipes</li> </ul>
	<p><b>MANAGE FOLDERS</b></p> <ul style="list-style-type: none"> <li>• Add or edit recipe folders</li> </ul>
	<p><b>MANAGE TABS</b></p> <ul style="list-style-type: none"> <li>• Add or edit recipe tabs</li> </ul>
	<p><b>NETWORK</b></p> <ul style="list-style-type: none"> <li>• Connect the oven to Wi-Fi</li> </ul>
	<p><b>LOAD FILE</b></p> <ul style="list-style-type: none"> <li>• Transfer a Menu file to the oven via USB Flash Drive</li> </ul>
	<p><b>USER OPTIONS</b></p> <ul style="list-style-type: none"> <li>• Modify a variety of user options such as key beep, temperature, etc.</li> </ul>

# Touch Screen Icon Descriptions

	<p><b>POWER ON ICON</b></p> <ul style="list-style-type: none"> <li>Press to preheat oven. <i>(Fan will continue to run if temperature is over 200°F / 95°C).</i></li> </ul>
	<p><b>MENU ICON</b></p> <ul style="list-style-type: none"> <li>Press to access a Menu Screen for manually editing recipes, changing user options, etc.</li> </ul>
	<p><b>HOME ICON</b></p> <ul style="list-style-type: none"> <li>Press to return to the Home Screen.</li> </ul>
	<p><b>TIME ENTRY</b></p> <ul style="list-style-type: none"> <li>Indicates the Time entry column in Manual Cooking entry.</li> </ul>
	<p><b>MICROWAVE POWER ENTRY</b></p> <ul style="list-style-type: none"> <li>Indicates the Microwave Power entry column in Manual Cooking entry.</li> </ul>
	<p><b>FAN POWER ENTRY</b></p> <ul style="list-style-type: none"> <li>Indicates the Fan Power entry column in Manual Cooking entry.</li> </ul>
	<p><b>SAVE ICON</b></p> <ul style="list-style-type: none"> <li>Press to Save a manually programmed recipe and return to the Main Screen.</li> </ul>
	<p><b>GREEN CHECK MARK ICON</b></p> <ul style="list-style-type: none"> <li>Press to begin cooking after manually entering a recipe. Press to Save changes.</li> </ul>
	<p><b>BACK ICON</b></p> <ul style="list-style-type: none"> <li>Press to return to previous Screen.</li> </ul>
	<p><b>NEXT ICON</b></p> <ul style="list-style-type: none"> <li>Press to move to next Screen.</li> </ul>
	<p><b>DELETE ICON</b></p> <ul style="list-style-type: none"> <li>Press to delete Menu Item, Folder, or Network.</li> </ul>
	<p><b>PAUSE ICON</b></p> <ul style="list-style-type: none"> <li>Press to pause a Cook Cycle.</li> </ul>
	<p><b>STOP ICON</b></p> <ul style="list-style-type: none"> <li>Press to cancel a Cook Cycle. Press to Stop and Return to the Main Screen.</li> </ul>
	<p><b>NEW FOLDER ICON</b></p> <ul style="list-style-type: none"> <li>Press to add new Folder.</li> </ul>
	<p><b>FOLDER ICONS</b></p> <ul style="list-style-type: none"> <li>Used to organize programmed recipes. Can be customized with color, icon, or image <i>Example: Pizza Folder - cheese pizza, pepperoni pizza, etc.</i></li> </ul>
	<p><b>TAB ICONS</b></p> <ul style="list-style-type: none"> <li>Used to organize programmed recipes. <i>Example: AM or PM Menus.</i></li> </ul>
	<p><b>PROGRAMMED RECIPE ICON</b></p> <ul style="list-style-type: none"> <li>Press to begin the Cook Cycle for the desired recipe.</li> </ul>

# Basic Oven Operation

## Power On Oven, Preheat

This oven can be set to a preheat temperature between 200°F (95°C) and 520°F (270°C).

Oven must be plugged in.  
(Screen will power on to “Standby Mode” within approximately 30 seconds.)



Press Green Power Icon

Preheat temperature of oven will appear in display.



Press the Power Icon again to interrupt preheating, or press the Blue Menu Icon to access Main Menu and User Options.



## Power Off Oven



At the end of the day, turn the oven off by pressing the Green Power Icon on the screen. The oven will begin cooling down.

The Oven Fan will continue to run to cool the oven.



Cooling Down Screen appears and stays on until oven temperature is below 200°F (95°C)

**⚠ Caution:** To avoid damage to the convection motor DO NOT turn off power by unplugging the oven or shutting off the power breaker until the fan stops.

## Methods of Cooking and Programming

- Cooking with Preprogrammed Menu Items
- Manual Cooking and Oven Programming
- Recipe and Menu creation via ACP Programming Application
- USB Programming
- Wi-Fi Programming
- Ethernet Programming

You may add and organize recipe information by creating new recipes, folders and tabs. See Section – **Manual Programming**.

To download and view example menus, please visit [acpsolutions.com/oven-programming/](http://acpsolutions.com/oven-programming/)

## First Time Use Set User Options

There are several options you can change to customize the operation of the oven for your business. To access and edit user options, see Section – **User Manual**.

Set Time and Date settings for current local time. This oven maintains a data log which is used to diagnose and troubleshoot errors. An accurate date and time are important for the data log.

# Preprogrammed Menu Items

The Home Screen on the oven displays Recipe Options. Scroll up and down with your finger to navigate through On-Screen Menus and Recipes. After the oven has preheated, the Menu appears. The high-speed oven comes preprogrammed with several Menu Items to simplify cooking.

## Standard Preprogrammed Menu Items:

- |                        |                        |
|------------------------|------------------------|
| 1. Breakfast Casserole | 10. Salmon             |
| 2. Breakfast Sandwich  | 11. Roasted Vegetables |
| 3. Omelet              | 12. Baked Potato       |
| 4. Tuna Melt           | 13. Ice Cream Sandwich |
| 5. Crab Cakes          | 14. Grilled Pineapple  |
| 6. Pizza               | 15. Chicken Wings      |
| 7. Reuben Panini       | 16. Fries              |
| 8. Muffuletta Panini   | 17. Shrimp             |
| 9. Fish Tacos          |                        |



## Cooking with Preprogrammed Menu Items

1. After oven has preheated to desired temperature, open oven door, place food in oven and close door.
2. Scroll to choose desired food item from Menu and press the Food Item you wish to cook. The Cook Cycle will begin and screen will show remaining Cook Time.

**Note:** If “Preheat Warning” is enabled and preheat temperature differs from default preheat temperature, the control will interrupt cook cycle to guarantee that oven reaches desired temperature before cook cycle begins. Enable “Preheat Warning” in user options.

3. At the end of the cooking cycle, the oven beeps and displays animation. Use oven mitts and/or paddle to carefully remove food from oven.



# Manual Cooking

**Note: “Manual cooking” must be enabled in user options (see Section – User Options)**

Use manual cooking when a specific entered time and cooking power levels are desired. Manual cooking is very useful when you are experimenting with new food items. Maximum Cook Time is 99:99 (100 minutes and 13 seconds). Microwave and Fan can be set to power levels between 0-100%.

**Note:** You may also create and edit recipes using the ACP Programming Application.



1. After oven has preheated press Blue Menu Icon.

**Note:** To guarantee that oven reaches the desired temperature before the start of cook cycle, enable “Preheat Warning” in user options.

2. Press the “Manual Recipe” option.

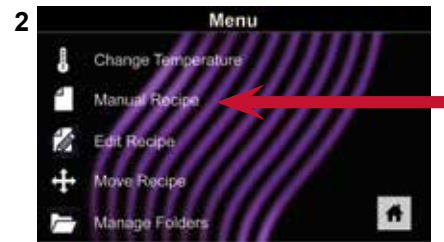

3. To change **cooking temperature** for recipe, press Temperature Icon on the left, and input new temperature. Two frequently used temperatures will appear for quick selection.

Press Green Check Mark Icon after inputting a temperature.



4. For Stage 1, enter **cooking time** by pressing Time Entry Box. A number pad will appear. Enter the desired Cook Time. Press the “OK” Icon.

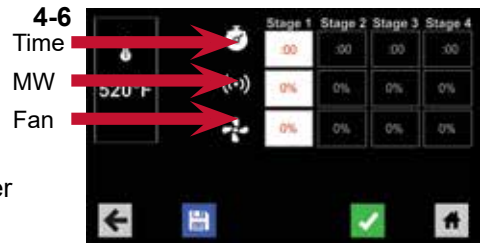

5. Select desired **microwave power** by pressing Microwave Power Entry Box. Choose from options ranging from 0% - 100%.



6. Select desired **fan speed** by pressing Fan Speed Entry Box. Choose from options ranging from 0% - 100%.



7. Repeat steps 4-6 for each cooking stage, if more than one cooking stage is necessary.

**Note:** To Save without cooking first, press the Save Icon. Follow instructions on the next page.



8. Open oven door and place food in oven. Press the Green Check Mark Icon to begin cooking. Once the cook cycle is complete, open door and use oven mitts and/or paddle to carefully remove food. The display will return to the Manual Input Screen. See instructions on next page to Save and Edit Menu Item from Manual Cook.

---

# 5

## **Programming**

**Manual Programming**

**Manual Organization: Folders**

**Manual Organization: Tabs**

**Oven Programming: USB Flash Drive**

**Oven Programming: Wi-Fi and Ethernet**

# Manual Programming

## Save a Menu Item from Manual Cook:



1. To Save the settings and create Menu Item, press the Blue Save Icon.
2. Choose a background color and icon, or an image, to customize the Menu Item.



3. Press the Right Arrow Icon to move to the next screen.
4. Name recipe and press the Green Check Mark Icon to Save.



5. To reorganize Menu Items, you may press, hold and drag them.
6. Press the Green Check Mark Icon to complete this step and Save the Menu Item.

**Note:** For larger and more complex menus, it may be more manageable to create and edit menus using the ACP Programming Application.

For detailed instructions, please visit: [acpsolutions.com/oven-programming/](http://acpsolutions.com/oven-programming/)

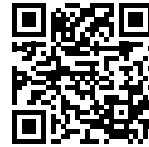

## Manually Edit an Existing Menu Item:



1. Press the Blue Menu Icon at the bottom of the screen.
2. Press the "Edit Recipe" option.
3. Press the desired recipe to be edited. The control will prompt you to the Manual Editing Screen where you may revise the Cooking Settings.



4. To delete the Menu Item, press the Orange Garbage Can Icon. Press the Green Check Mark Icon to confirm, or press the "X" to dismiss.



**Note:** Skip the following step if you do not want to cook anything.



5. Open the oven door and place the food in the oven. Press the Green Check Mark Icon to begin cooking with the revised Menu Item settings. The display will return to the Manual Input Screen at the end of the Cook Cycle.



6. Press the Right Arrow Icon to Save any changes made to Cook Settings and move to the next screen.



7. If desired, choose a different background color. Press the Right Arrow Icon to select an image at the next screen. Press the Right Arrow Icon again to move to the next screen.



8. If desired, change the name of the recipe. Press the Green Check Mark Icon to Save the Menu Item.

## Manually Move Recipe:



1. Press the Blue Menu Icon at the bottom of the screen.
2. Press the "Move Recipe" option.
3. Press, hold, and drag recipes to different locations on the screen.
4. To move a recipe into a folder, press, hold and drag the recipe to the folder.
5. To move a recipe out of a folder, press, hold and drag the recipe to the top of the screen.



# Manual Organization: Folders

## Manually Create a Recipe Folder:

*Note: You may also create folders using the ACP Programming Application.*



1. Press the Blue Menu Icon at the bottom of the screen.
2. Press the "Manage Folders" option in the Menu Screen.



3. To create a new folder, press the Grey Folder Icon at the bottom of screen.



4. Choose a background color and icon, or an image, to customize the folder. Confirm that your new folder appears on the Main Screen. Press the Right Arrow Icon.



5. Name folder and press the Green Check Mark Icon to Save.



6. Confirm that your new folder appears on the Main Screen. Press the Green Check Mark Icon again to Save the new folder.

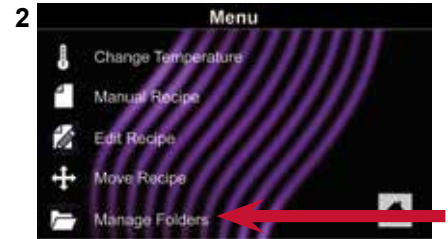

## Manually Edit an Existing Recipe Folder:

*Note: You may also edit folders using the ACP Programming Application.*



1. Press the Blue Menu Icon at the bottom of the screen.
2. Press the "Manage Folders" option in the Menu Screen.
3. Press the desired folder to be edited.



4. **To delete the Folder:** Press the Orange Garbage Can Icon. Press the Check Mark Icon to confirm deletion. Or, press the "X" to dismiss.



5. If desired, select a different photo, icon, or color for the folder. Press the Right Arrow Icon to move to the next screen.

6. If desired, change the name of the recipe.



7. Press the Green Check Mark Icon to Save changes.



8. Press the Green Check Mark Icon once more to Save the revised folder.



# Manual Organization: Tabs

## Manually Create a Recipe Tab

**Note:** You may also add recipe tabs using the ACP Programming Application.



1. Press the Blue Menu Icon at the bottom of the screen.
2. Press the "Manage Tabs" option in the Menu Screen.



3. Press the "Add Tab" option.
4. A new tab will appear at the top of the screen.



5. Press the Home Icon to return to the Main Screen.

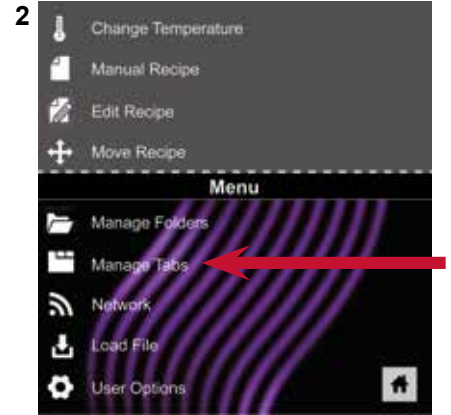

## Manually Edit an Existing Recipe Tab

**Note:** You may also edit tabs using the ACP Programming Application.



1. Press the Blue Menu Icon at the bottom of the screen.
2. Press the "Manage Tabs" option in the Menu Screen.

3. Press the desired tab to be edited.



**Change the image on the tab:** Press the "Choose Icon" option. Select an image. Press the Green Check Mark Icon.



**Add text to the tab:** Press the "Enter Text on Tab" option. Enter the desired text. Press the Green Check Mark Icon to Save.

**Relocate the tab:** Press the "Move Tab Right" or "Move Tab Left" option.

**Delete the tab:** Press the "Delete Tab" option.



4. After changes have been made, press the Home Icon to Save and return to the Main Screen.

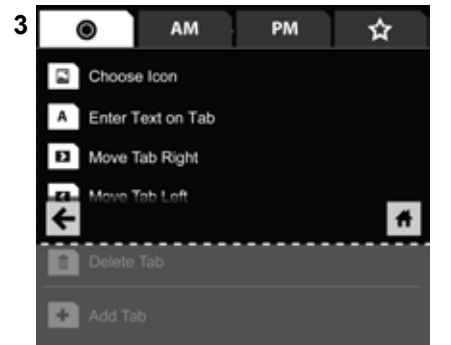

# Oven Programming: USB Flash Drive

**Caution:** Uploading a new file will overwrite existing items on oven. To ensure items are not lost, first backup files by exporting to USB drive.

## Export Menu via USB Flash Drive



1. Press the Blue Menu Icon at the bottom of the screen.
2. Scroll down and press the "Load File" option.
3. When prompted, insert the Flash Drive into the USB port.

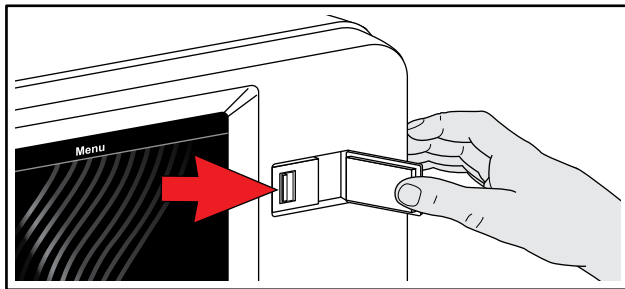

4. When prompted, select "Export Files". "Copying Files" Screen will appear. **DO NOT** remove USB Flash Drive until "Success" Screen appears.



5. Once the files have copied, press the Home Icon to return to the Main Screen. Remove USB Flash Drive. Settings and Menu Items will be loaded on USB Flash Drive and ready to share or open in ACP Programming Application.



## Open Menu in ACP Programming Application

**Note:** For more comprehensive instructions, see *ACP Programming Application User Guide* online.

1. Insert Flash Drive into USB port on computer.
2. Open ACP Programming Application.
3. Select "File," then "Open." Navigate to Flash Drive.
4. Select the Menu file and Open.

## Import Menu via USB Flash Drive



1. Press the Blue Menu Icon at the bottom of the screen.
2. Scroll down and press the "Load File" option.

**Caution:** Uploading a new file will overwrite existing items on oven. To ensure items are not lost, first backup files by exporting to USB drive.

3. When prompted, insert the Flash Drive into the USB port.
4. Press the desired file to be uploaded.



5. Once file has uploaded, press the Home Icon to return to the Main Screen. Settings and Menu Items will now be loaded and ready to use.



# Oven Programming: Wi-Fi and Ethernet

## Connect Oven to Network:



1. Press the Blue Menu Icon at the bottom of the screen.
2. Press the "Network" option.
3. Connect to network using your choice of Ethernet or Wi-Fi:

### To connect via Wi-Fi

- Enable Wi-Fi capability by pressing the "ON" option.
- Select the desired Wi-Fi network. Enter the network's password. If the network does not immediately appear, press "Search" to locate the Wi-Fi network.

### To connect via Ethernet:

- Make sure the Ethernet cord is plugged into the back of the oven and wall jack. If necessary, use pliers to gently remove plastic plug from Ethernet port on right rear of oven.
- Insert Ethernet cable.

## Connect Computer to Oven via Wi-Fi/Ethernet:

1. Connect computer to same network and enter password.
2. An IP address will appear on oven control once it has connected to the network.
3. Open an internet browser window on computer and type in the IP address exactly as it appears on oven screen.
4. Enter your log-in information:

Log-in Information	
Username	ACP_MXP
Password	Express

5. The oven and computer are now connected.

## Transfer Recipe Information via Wi-Fi/Ethernet:

1. After connecting the computer to the oven and logging in, click on the "Upload Recipes" tab in browser window.

**Caution:** Uploading a new file will overwrite existing items on oven. To ensure items are not lost, first backup files by exporting to USB drive.

2. Upload Menu file by following the instructions on web page.



3. Press the Green Check Mark Icon.

4. Once the file has been fully uploaded, a message will appear that says "Upload Successful!" The recipes will be imported when the oven enters Standby Mode.



5. To cycle the oven through Standby Mode, press the Home Icon then the Green Power Icon. Oven will begin cooling down.



6. Press the Red Stop Icon to return to Home Screen. Menu items and settings will be uploaded and ready to use.



2

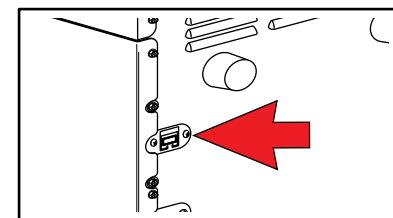
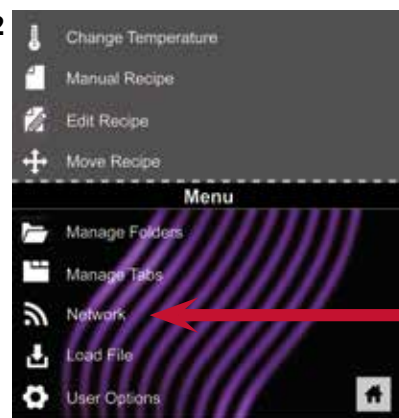

**Need to update recipe information for multiple locations?**

Contact us at [commercialservice@acpsolutions.com](mailto:commercialservice@acpsolutions.com) for more details about SFTP and Enterprise Wi-Fi support.

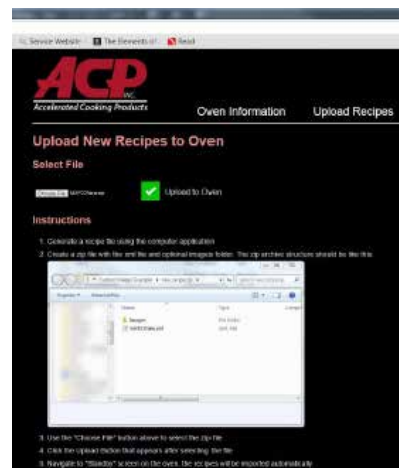

---

# 6 | Care and Cleaning

# Care and Cleaning

Follow the recommendations below and on the following page for proper maintenance of ARX & MRX ovens.

**⚠ Caution:** The use of caustic cleaning products or those containing ammonia, phosphates, chlorine, sodium or potassium hydroxide (lye) can damage critical oven parts. **DO NOT** use water pressure type cleaning systems. **Use of unapproved cleaning agents will void the terms of the warranty.**

## Recommended Cleaning Supplies:

Damp towel, plastic scouring pad, ACP Oven Cleaner (Item [CL10](#) (US), Item [CL10W](#) (EU), ACP Oven Shield Oven Protectant (Item [SH10](#) (US), Item [PR10W](#) (EU), mild liquid dishwashing detergent, rubber gloves, safety glasses, microfiber cloth

## For a new oven, before using it for the first time:

When oven is clean, spray damp towel with ACP Oven Shield Protectant ([SH10](#)) and wipe all interior surfaces. **DO NOT** remove Oven Shield. Turn oven on and pre-heat to start cooking.

**⚠ WARNING**

Wear protective gloves and protective glasses when cleaning the oven.

To prevent burns, handle utensils, accessories, and door with care. Allow oven, utensils, and accessories to cool before cleaning. Oven, utensils, and accessories become hot during operation.

Failure to maintain the oven in a clean condition could lead to deterioration of the surface that could adversely affect the life of the appliance and possibly result in a hazardous situation.

## Best Practices

- DO** clean oven daily.
- DO** use non-caustic cleaner.
- DO** wear protective gloves and glasses while cleaning.
- DO** always use recommended cleaning supplies: Damp towel, plastic scouring pad, ACP Oven Cleaner ([CL10](#)) and ACP Oven Shield Protectant ([SH10](#)).
- DO** allow oven and tools to cool before cleaning.
- DO** remove food from oven at end of cycle.
- DO** use only accessories that are both high temperature oven-safe and microwave-safe.
- DO** wash cook plate with warm, soapy water and air dry.
- DO** place cookware in center of oven rack, not touching oven sides.

- DO NOT** use caustic cleaning products or those containing ammonia, phosphates, chlorine, sodium or potassium hydroxide (lye).
- DO NOT** use water pressure style cleaning systems.
- DO NOT** spray cleaning solution into perforations.
- DO NOT** use abrasive scouring pads to clean cavity ceiling cover or red sealant in cavity corners.
- DO NOT** cook foods with plastic wrap on them.
- DO NOT** operate oven without a load (empty) in Microwave Mode.

# Care and Cleaning

DAILY CLEANING	
1. PREPARE OVEN	<ol style="list-style-type: none"> <li>Shut oven off by pressing ON/OFF button. The fan will run for a few minutes to cool the oven interior faster. Allow the oven interior to reach room temperature before cleaning. <b>Note:</b> <i>To accelerate cool down time of oven, put a tray filled with ice in oven cavity after shutting the oven down.</i></li> <li>Once cooled, remove cook plate and other accessories from the cavity.</li> </ol>
2. CLEAN OVEN INTERIOR	FOR OVENS WITH NON-STICK LINERS
	<ol style="list-style-type: none"> <li>Using a warm, damp, clean towel, wipe the oven interior. Rinse the towel and wring dry. Repeat 2-3 times to remove remaining particles from the oven.</li> <li><b>FOR STUBBORN DEBRIS</b>, use ACP Oven Cleaner (CL10):               <ol style="list-style-type: none"> <li>Wear rubber gloves and safety glasses. Spray oven door and cavity with ACP Oven Cleaner (CL10). Avoid spraying into perforations. Allow cleaner to soak for 2 minutes. <b>⚠ CAUTION: DO NOT spray cleaning solution into perforations.</b></li> <li><b>WIPE OVEN INTERIOR.</b> Using a damp clean towel, wipe the oven interior, then rinse the towel and wring dry. Repeat 2-3 times to remove remaining oven cleaner and particles from the oven.</li> </ol> </li> </ol>
2. CLEAN OVEN INTERIOR	FOR OVENS WITHOUT NON-STICK LINERS
	<ol style="list-style-type: none"> <li><b>⚠ CAUTION:</b> Wear rubber gloves and safety glasses. <b>CLEAN OVEN INTERIOR:</b> Spray oven door and cavity with ACP Oven Cleaner (CL10). <b>⚠ CAUTION: DO NOT spray cleaning solution into perforations.</b></li> <li>Allow cleaner to soak for 2 minutes.</li> <li>Clean metal portions of the oven door and interior using a plastic scouring pad.</li> <li>Clean cavity ceiling cover with a damp cloth sprayed with cleaner and apply gentle pressure to clean cavity ceiling cover.</li> <li>Clean perforated area with damp cloth sprayed with cleaner.</li> <li><b>WIPE OVEN INTERIOR.</b> Using a damp clean towel, wipe the oven interior, then rinse the towel and wring dry. Repeat 2-3 times to remove remaining oven cleaner and particles from the oven.</li> <li><b>APPLY OVEN SHIELD.</b> When oven is clean, spray a thin layer of ACP Oven Shield (SH10) on all interior surfaces. Do not remove Oven Shield.</li> </ol>
3. CLEAN ACCESSORIES	<ol style="list-style-type: none"> <li><b>CLEAN COOK PLATE:</b> Allow cook plate to cool before cleaning,</li> <li>Clean the cook plate with liquid dishwashing detergent such as Dawn®, and a non-abrasive sponge or soft bristle brush.</li> <li><b>FOR STUBBORN DEBRIS:</b> Soak cook plate in hot, soapy water for 10 minutes. Burnt-on foods should lift off after soaking.</li> <li>Maintain with Bar Keeper's Friend® cleanser and a plastic scouring pad, being sure to rinse thoroughly. <b>⚠ CAUTION: DO NOT use lye-based cleaners (e.g., sodium hydroxide) as they react with aluminum and will degrade the surface.</b></li> <li>For other accessories, please refer to instruction sheet included in original packaging.</li> </ol>
4. CLEAN OVEN EXTERIOR	<ol style="list-style-type: none"> <li><b>CLEAN EXTERIOR DOOR</b> and other surfaces with a clean cloth, sponge or nylon pad; using a mild detergent and warm water solution.</li> <li><b>CLEAN TOUCHSCREEN</b> with a dry or damp microfiber cloth. <b>⚠ CAUTION: DO NOT use Windex or other harsh chemicals. DO NOT spray liquid on the screen.</b></li> </ol>
WEEKLY CLEANING	
1. CLEAN AIR FILTERS	<ol style="list-style-type: none"> <li>Remove all 3 of the Magnetic Air Filters located along the front base and sides of the oven. <b>⚠ CAUTION: DO NOT operate oven without Air Filters in place.</b></li> <li>Wash filters in a mild detergent solution made with warm water.</li> <li>Rinse and dry thoroughly.</li> <li>Place the clean filters on oven front base and sides.</li> </ol>

---

# 7 | **User Options**

## **Default User Options**

# User Options

There are several options you can change to customize the operation of the oven for your business. The table on the following page shows these options. **The factory setting is shown in bold type.**

## Access and Modify User Options:



1. Press the Blue Menu Icon at the bottom of the screen.
2. Scroll down and press to select User Options.



3. Use this Menu to modify Oven Settings.
4. Press the Left Arrow Icon to return to the Menu after making each change.

**Note:** You may also make User Options changes using the ACP Programming Application.

**Note:** Programming the Preheat Temperature in the User Options Menu will set the oven to heat to a certain temperature each time it is powered on.

2

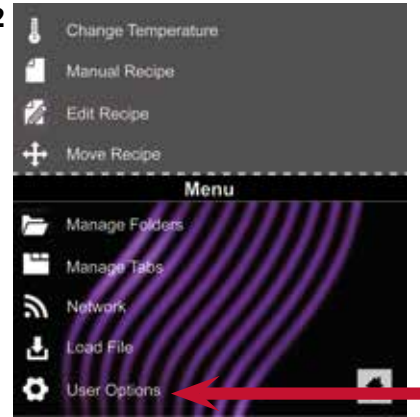

### TIME AND DATE

This oven maintains a data log of information, including date and time of operation. This information is used to diagnose and troubleshoot errors. An accurate date and time are important for the data log.

1. Select **Time**. Choose format (12 HR or 24 HR). Enter local time.
2. Press the Left Arrow Icon to return.
3. Select **Date**. Choose format (MM/DD/YYYY or DD/MM/YYYY). Enter today's date.
4. Press the Left Arrow Icon to return.

### ALLOW MANUAL COOK

**Allow Manual Cook** option must be enabled to view **Allow Manual Save** options.

### PIN CODE

If enabling **PIN Code**, select a 4-digit numeric PIN. PIN Code must be enabled before trained technician may enter *Service Mode*.

### CLEAN FILTER REMINDER

When "Clean Filter" message displays, clean air filters thoroughly.

**Cleaning the air filters will not shut off message.**

Message will automatically stop displaying after 24 hours.

- a. Check "Filter Cleaned" box to confirm clean.
- b. Select "Dismiss" to close popup.



**Note:** If "Filter Cleaned" box is checked, reminder time resets.

Necessary cleaning frequency of air filters dependant on microwave use and environmental conditions. Once frequency is determined, set the user option for appropriate time frame.

Air filters and vents must be cleaned regularly to prevent overheating of oven. Refer to "1. Clean Air Filters" on page 30 for cleaning instructions.

### PREHEAT WARNING

To guarantee that oven reaches the desired temperature before the start of cook cycle, enable **Preheat Warning** in user options. Enable setting when using recipe with different starting temperature than default **Preheat Temperature**.

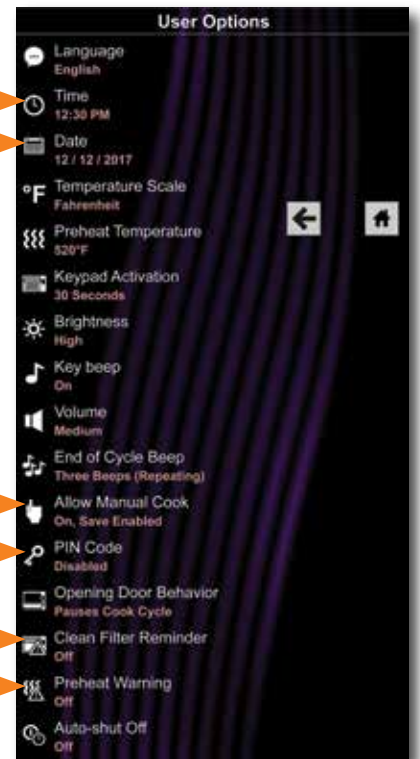

# Default User Options

The table below shows the standard user options. The factory setting for each Model is shown in bold type.

User Option	STANDARD DEFAULT PER MODEL	
	ARX & MRX, 60Hz	ARX & MRX, 50Hz
Language	<b>English</b> , Chinese (Mandarin), Japanese, Korean, Russian, German, French, Italian, Polish, Danish, Greek, Latin, Swedish, Portuguese, Spanish, Thai, Lao, Dutch, Vietnamese, Arabic, Ukrainian, Filipino, Norwegian, Hindi, Bengali	<b>English</b> , Chinese (Mandarin), Japanese, Korean, Russian, German, French, Italian, Polish, Danish, Greek, Latin, Swedish, Portuguese, Spanish, Thai, Lao, Dutch, Vietnamese, Arabic, Ukrainian, Filipino, Norwegian, Hindi, Bengali
Time <i>*time entry can be customized by hour and minute</i>	*12 Hr *24 Hr	*12 Hr *24 Hr
Date <i>*date entry can be customized by day, month, and year</i>	*MM / DD / YYYY *DD / MM / YYYY	*MM / DD / YYYY *DD / MM / YYYY
Temperature Scale	Celsius <b>Fahrenheit</b>	<b>Celsius</b> Fahrenheit
Preheat Temperature <i>200°F - 520°F (93°C - 270°C)</i>	<b>520°F ( 270°C )</b>	<b>270°C ( 520°F )</b>
Keypad Activation	<b>30 seconds</b> 60 seconds 2 minutes	<b>30 seconds</b> 60 seconds 2 minutes
Brightness	Low Med <b>High</b>	Low Med <b>High</b>
Key Beep	<b>On</b> Off	<b>On</b> Off
Volume	Low <b>Medium</b> High	Low <b>Medium</b> High
End of Cycle Beep	Three Beeps (Once) <b>Three Beeps (Repeating)</b> Continuous Until Door is Opened	Three Beeps (Once) <b>Three Beeps (Repeating)</b> Continuous Until Door is Opened
Allow Manual Cook	<b>On</b> Off	<b>On</b> Off
Allow Manual Save	<b>On</b> Off	<b>On</b> Off
PIN Code <i>*must be a 4-digit numeric PIN</i>	*On <b>Off</b>	*On <b>Off</b>
Opening Door Behavior	Reset Timer <b>Pauses Cook Cycle</b>	Reset Timer <b>Pauses Cook Cycle</b>
Clean Filter Reminder	Every 7 Days Every 30 Days Every 90 Days <b>Off</b>	Every 7 Days Every 30 Days Every 90 Days <b>Off</b>
Preheat Warning	On <b>Off</b>	On <b>Off</b>
Auto Shut Off	2 Hours 4 Hours 8 Hours <b>Off</b>	2 Hours 4 Hours 8 Hours <b>Off</b>

---

# 8 | **Firmware Update Procedure**

# Firmware Update Procedure

The Touch Control is designed to be updated as future technology and programming requirements change. Should new Firmware be required follow the steps below.

Firmware Updates are available at: <http://acpsolutions.com/oven-programming/>

1. Ensure the oven is powered ON.



2. If the Standby (OFF) Screen is showing, press the Green Power Icon.



3. Press the Blue Menu Icon.

4. If the PIN is enabled, enter 1-3-5-7-9 to access Service Mode. If the PIN is not enabled the Menu will appear.

A. Press and drag up to scroll to the bottom of the Menu and select "User Options".

B. Press and drag up to scroll down through the user options and select "PIN Code".



C. Select ON, enter and remember a 4-digit Pin Code and then select the Home Icon.



D. Now press the Blue Menu Icon and enter 1-3-5-7-9 to access Service Mode.



5. Ensure the Software Version displayed is less than the version being installed. Press the Home Icon and proceed to program loading.

6. Select "Software Version".

7. Insert the USB/Flash Drive with the new firmware into the USB port.

8. A box will appear in the lower portion of the screen "Rev "xxxx" Available Begin Update".

9. Press this box to begin firmware update. The screen will now display "Entering Standby Mode" for a few seconds and then the screen will go blank. Continue to wait.

10. The screen will blink, then a few seconds later the Startup logo will appear. Underneath will appear the word "Updating" along with a progress bar. Continue to wait. **Note: DO NOT** remove the USB/Flash Drive until **AFTER** the reboot is completed.



11. After about two minutes the words "Update Complete" will appear and a Green "Reboot" Icon will appear. **DO NOT** remove the USB/Flash Drive. Press the Green Icon.

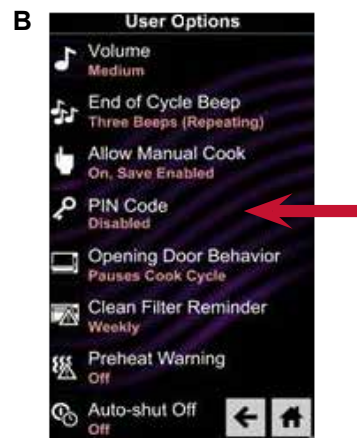
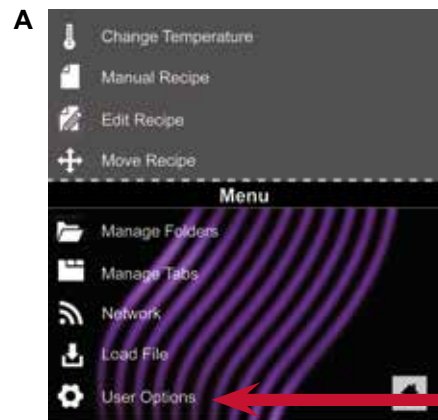

# Firmware Update Procedure

---



12. Once the ACP logo and Green Power Icon appear, remove the Flash Drive and press the Green Power Icon. **12**



13. Press the Blue Menu Icon and enter 1-3-5-7-9 to access Service Mode.

14. Verify the Software Version displayed is new version.



15. Press the Home Icon.

16. The Firmware Update is complete.

---

# 9 Troubleshooting

**Before Calling for Service**

**Service Test Mode**

**Oven Tests**

**Error Codes**

**Troubleshooting Chart**

# Before Calling for Service

## ⚠ WARNING

To avoid electrical shock which can cause severe personal injury or death, do not remove outer case at any time. Only an authorized servicer should remove outer case.

This is a Class A product. In a domestic environment this product may cause radio interference in which case the user may be required to take adequate measures.

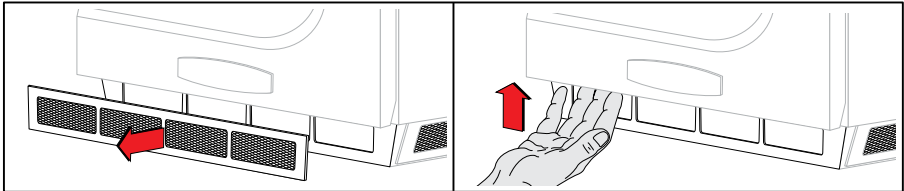
PROBLEM	POSSIBLE CAUSE
Oven does not operate	Confirm oven is plugged in. Confirm oven is connected to a grounded circuit. Check fuse or breaker.
Oven operates intermittently	Check air filters and discharge air vents.
Oven does not accept entries when pad is pressed	Make sure oven is preheated. Open and close door, press pad again.
Oven fan turns on while oven is not preheating or cooking	Normal operation
When I turn the oven OFF, the display is still lit	Normal operation
Clean Filter displays	This is normal and will appear for 24 hours.
Frozen oven display	Oven display needs to reset.  <b>Models without reset button:</b> <i>Unplug oven. Wait 5 seconds. Plug back in.</i>  <b>Models equipped with reset button:</b> a. Remove front magnetic air filter. b. Reach through far left hand air intake hole and press upwards on button to reset oven.  
"G0" error displays on Screen	Oven Exceeded Max. Temp. <i>After oven cools, press the red reset button found on back, bottom-right hand corner of oven. If "G0" error continues to appear, or reoccurs, contact ACP, Inc. ComServ Customer Service</i>

Amana® Commercial ARX  
Contact:



866-426-2621

MenuMaster® MRX  
Contact:



866-811-8559

email: [commercialservice@acpsolutions.com](mailto:commercialservice@acpsolutions.com)

For full product documentation visit:  
[www.acpsolutions.com](http://www.acpsolutions.com)

# Service Test Mode

## Service Test Mode:

The Service Mode is a useful tool to aid in diagnosing any service issue. To access the oven's Service Test Mode, the PIN Code must be enabled. If the PIN Code is not enabled, enable it (see below). To determine if the PIN CODE is enabled, press the Blue Menu Icon. If the PIN Code prompt appears it is enabled. The Touch Control System installed in this model is used in other ovens, so some components tests will not work properly.

## With the PIN Code enabled:



1. Press Green start pad.



2. Press the Blue Menu Icon and the PIN Code prompt will display.
3. Enter, in order, 1, 3, 5, 7, 9 (the odd numbers) and the Service Mode is initiated.



## With the PIN Code not enabled:

If the PIN Code is not enabled, it must be enabled in the User's Options.



1. With oven on, press the Blue Menu Icon at the bottom of the screen and the PIN Code prompt will display.
2. Scroll screen to User Options and press it.
3. Scroll screen to PIN Code (it will say "DISABLED" underneath) and press it.
4. Press the radial pad "On" and ensure it is lit.
5. Enter 1,2,3,4 as PIN Code and memorize, take a picture, or write it down.

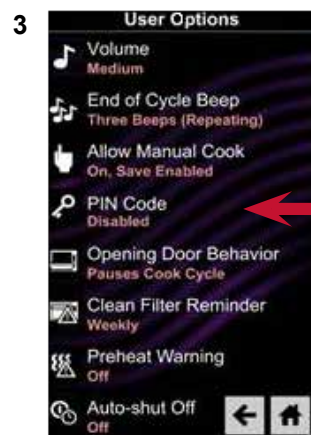

6. Press the Home Icon to return to Main Screen.



# Service Test Mode

7. Press the Blue Menu Icon and the PIN Code prompt will display.
8. Enter, in order, 1, 3, 5, 7, 9 and the Service Mode is initiated.

Once the Service Mode is initiated a menu of options and information is displayed. The Menu Screen can be navigated by swiping up or down if needed.

Some components can be activated from this Menu – See example of Magnetron 1, by pressing Start to start or Stop to stop. Pressing the Back Arrow Icon will return back one screen. Pressing the Home Icon returns to opening screen.

7

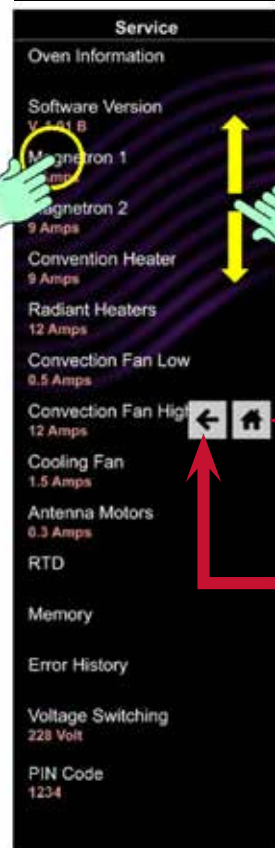
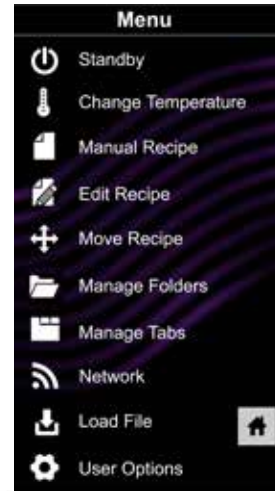

Press

Swipe

Home

Back  
(Left)  
Arrow

# Service Test Mode

Service Mode	Purpose	Comments
<b>Oven Information</b>	Provide service provider with Door Cycles and Magnetron Tube Hours of operation.	Press and the following will display: Door Cycles: Tube Hours:
<b>Software Version</b>	Displays the version of software and firmware installed in the control.	Press and the following will display: SW: EE: App:
<b>Magnetron 1 Right Side</b>	System can be started and stopped by pressing the Start or Stop Icon.	The current amperage being drawn by the HV system. 5 -12 amps is considered normal. Look for consistent reading with Magnetron 2 and Convection Heater. This circuit is protected by Fuse F3.
<b>Magnetron 2 Left Side</b>	System can be started and stopped by pressing the Start or Stop Icon.	The current amperage being drawn by the HV system. 5 -12 amps is considered normal. Look for consistent reading with Magnetron 1 and Convection Heater. This circuit is protected by Fuse F4.
<b>Both Magnetrons</b>	Both systems can be started and stopped by pressing the Start or Stop Icon.	The current amperage being drawn by BOTH HV systems. Look for consistent readings with Convection Heater. These are protected by Fuses F3 & F4.
<b>Convection Heater</b>	Heater can be stopped and started by pressing the Start or Stop Icon.	The current amperage being drawn by the Convection Heater. 7-15 amps is considered normal. This circuit protected by Fuse F5.
<b>Radiant Heaters</b>	Not Used for this model.	
<b>Convection Fan Low</b>	Convection Fan Motor Low Speed can be stopped and started by pressing the Start or Stop Icon.	The current amperage being drawn by the Convection Fan Motor on low speed. <2 amps and fan motor operating noise is considered normal. This circuit is protected by Fuse F2.
<b>Convection Fan High</b>	Convection Fan Motor High Speed can be stopped and started by pressing the Start or Stop Icon.	The current amperage being drawn by the Convection Fan Motor on high speed. <3 amps and a high speed fan motor operating noise is considered normal.
<b>Cooling Fan</b>	Motors can be stopped and started by pressing the Start or Stop Icon.	The current amperage being drawn by both the Cooling Fan Motors. 1-3 amps is considered normal. A failed Cooling Fan motor will likely result in a G2 Error Code.
<b>Antenna Motor</b>	The Antenna Motor can be started by pressing the Start Icon. <b>NOTE:</b> The Stop Icon will not stop the Antenna Motor.	USE RADIANT RTD READING ONLY. The Radiant RTD is located between the Magnetrons on top of the oven. To reset maximum temperature reading, press and hold the Max Radiant RTD for several seconds - temperature will change to then current temperature sensed.
<b>RTD</b>	Resistive Thermal Devices (Temp Sensors) Press and the current temperature sensed by the RTD along with the maximum temperature recorded.	MRX OVENS ONLY HAVE ONE RTD AND MAXIMUM READING IS NOT USED. "NON USED" READING WILL BE 656 or 657 – USE RADIANT RTD READING ONLY. The Radiant RTD is located at the back center of oven. The Convection RTD is located on the upper left by the Convection Element. To reset maximum temperature reading, press and hold the Max Convection RTD for several seconds—temperature will change to the current temperature sensed.
<b>Memory</b>	Attached Memory Devices	Press and the following will display: USB Present or Absent SD Card Present or Absent
<b>Error History</b>	Chronological List of Errors experienced by the Control.	Press and the following will display: Error Code Date, Time, and Code (see Error Code List in this section)
<b>Voltage Switching</b>	Displays the voltage as sensed by the Control.	Pressing has no effect.
<b>Temperature Offset</b>	The degree of offset programmed into Control to synchronize Control to cavity temperature.	Press and the following will display: The amount of temperature offset programmed by the factory
<b>Pin Code</b>	Displays the 4 Digit Pin Code	Pressing has no effect.

# Oven Tests

---

All ACP Microwave Oven Power Outputs are rated using the IEC705 standards. Using the IEC705 test method requires precision measurements and equipment that is not practical to be performed in the field. Using the following tests will indicate if the oven is performing satisfactorily.

## Power Test

### Set Up:

- Oven MUST be at room temperature for accurate results.
- Service Test Mode: Both Magnetrons.

### Equipment:

- 1000ml test container
- Thermometer

### Procedure:

1. Fill the test container with cool tap water, as close to 60°F (16°C) as possible.
2. Using the thermometer, stir the water for 10 seconds; measure and record the temperature.
3. Place the container of water in the center of the oven and close the door.
4. Heat the water on full power for 33 seconds.
5. At the end of the cycle, remove the container from the oven.
6. Once again, stir the water for 10 seconds, take another measurement and record.
7. Subtract the starting water temperature from the ending water temperature to obtain the temperature rise.
8. If the temperature rise meets or exceeds the nominal microwave energy output rating found on the oven's model/serial tag, the test is complete.
9. If the temperature rise fails to meet the minimum, test the incoming line voltage to verify it is correct.
10. Before retesting replace the water as in Step 1.

Repeat Steps 2 – 7. If the temperature rise fails to meet the minimum, the oven needs to be serviced.

$\Delta T$ (°F)	Cooking Output Power (W)	$\Delta T$ (°F)	Cooking Output Power (W)	$\Delta T$ (°C)	Cooking Output Power (W)	$\Delta T$ (°C)	Cooking Output Power (W)
10	1000	20	2000	5	1000	11	2000
11	1100	21	2100	5.5	1100	11.5	2100
12	1200	22	2200	6.5	1200	12	2200
14	1400	24	2400	7.5	1400	13	2400
17	1700	25	2500	9.5	1700	13.5	2500
18	1800	27	2700	10	1800	15	2700
19	1900	30	3000	10.5	1900	16.5	3000

## Microwave Leak Test

The leakage reading must be recorded on the service repair documentation while in the customer's premises.

Check for radiation leakage after servicing.

Should the leakage be more than  $4\text{mW}/\text{cm}^2$ , **Contact ACP ComServ**. After repairing or replacing any microwave radiation safety device, keep a written record for future reference, as required by Federal CDRH / FDA / DHHS and State regulations.

### Tools required for test:

- 600ml glass beaker
- Supply of cold water ( $68^\circ\text{F} \pm 9^\circ\text{F} / 20^\circ\text{C} \pm 5^\circ\text{C}$ )
- Microwave leakage meter

**NOTE: Read and understand the following information and the procedure before performing the measurements.**

Make sure the survey meter you are using has been calibrated and is suitable for measuring frequencies of 2,450 MHz.

Leakage meter should initially be set to the highest scale then adjust to lower scales to ensure low readings are measured on the most sensitive range.

When measuring the leakage, use the probe supplied with the instrument. Always hold the probe at right angles to the oven and point of measurement.

# Oven Tests

---

## Measuring Procedure

1. Fill the glass beaker with 275 ml of cool water and place in center of oven. Close door.



2. After oven has preheated, press the Blue Menu Icon.

3. Press the *Manual Recipe* option

4. Enter **cooking time** by pressing the Time Entry Box **4-6**. A number pad will appear. Enter 30 seconds Cook Time.



5. Press the "OK" Icon.

6. Select desired **microwave power** by pressing Microwave Power Entry Box. Enter 100%



7. Select desired **fan speed** by pressing the Fan Speed Entry Box. Enter 0%.



8. Press the Green Check Mark to begin.

9. Move the Meter Probe at 1"/sec. over all door/oven gaps.

**NOTE: Water must be changed every 30 seconds to prevent boiling. If water boils the results may be inaccurate.**

10. Make a note of any area that exceeds 4mW/cm<sup>2</sup>.

11. Return the probe to any "spike areas" and allow it to remain for 17 seconds. Make a note of the highest reading.

12. When test is complete, open door and dispose of water.

3

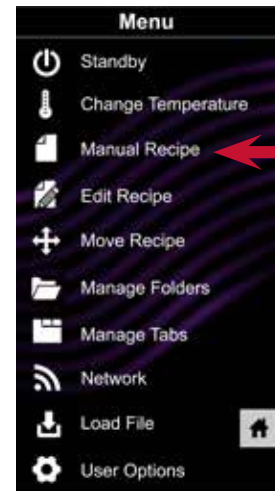

# Error Codes

Code	Description	Corrective Action
<b>A2</b>	Invalid Display Firmware	Update Firmware or Replace Touch Control
<b>B1</b>	Touch Screen Error	Replace Touch Control
<b>B2</b>	Wi-Fi Error	Reset Touch Control. If continued failure, replace Touch Control
<b>B3</b>	Wi-Fi Error	Reset Touch Control. If continued failure, replace Touch Control
<b>D0</b>	Convection Temp Sensor (RTD)-Open	Replace Temp Sensor (Top Left of Oven)
<b>D1</b>	Convection Temp Sensor (RTD)-Shorted	Replace Temp Sensor (Top Left Oven)
<b>G0</b>	Oven Exceeded Max. or Min. Temperature	After oven cools, press the Oven Thermal Cutout's reset button found on the back, right-hand bottom corner of oven. If unable to reset, replace the Oven Thermal Cutout. <b>NOTE:</b> Cutout may trip if subjected to sub-freezing temperatures
<b>G2</b>	Open Magnetron TCO	Board Senses an Open Magnetron TCO. Inspect Cooling Fans operation and airflow, TCO's and Wiring.
<b>H0</b>	Zero Cross Failure	No or Intermittent Voltage at J1 Connector on Main Control. Test Main Control and wiring. Repair or replace as needed.
<b>H2</b>	Invalid System State	Test Main Control Board and replace as needed.
<b>H3</b>	Invalid EEPROM/FLASH	Test Main Control Board and replace as needed.
<b>I1</b>	Current Sense-No/Low Amps from Microwave Circuit	Perform Service Test (Magnetron #1 & #2). Test Door Switches are activating. Check for weak door hinges. Correct as needed. Adjust Secondary/Monitor Switch assembly for correct actuation.
<b>V0</b>	Low Voltage	<188VAC Detected by the Main Control Board. Check and correct incoming voltage.
<b>V1</b>	High Voltage	>263VAC Detected by the Main Control Board. Check and correct incoming voltage.

**Important Note:** Error Code History cannot be cleared. Oldest codes will automatically be deleted when the history log is full.

# Troubleshooting Chart

SYMPTOM	POSSIBLE CAUSE	REMEDY
<b>Oven will not operate No Display</b>	Incoming Power Supply	Check all electrical connections. Check for power at wall receptacle. Check Fuse F1.
<b>Oven will not operate Magnetrons</b>	Oven door not closed	Ensure that oven door is fully closed. Check for interference. Check door seal.
	Door Interlock Switches	Inspect Door Interlock Switches to ensure the switches are mechanically actuating when door is closed and adjust if necessary. Ensure power output from switches. See Interlock Switch testing.
	Power Relay	Check power input to Coil. Check power output. See Power Relay testing.
	Transformer Triac	Check power input. See Triac testing.
	HV Transformer	Do Not Test Live! See HV Transformer testing.
	HV Capacitor	DO NOT Test Live! See HV Capacitor testing.
	HV Rectifier/Diode	DO NOT Test Live! See HV Rectifier testing.
	Magnetron TCO Error Code G2	Allow oven to cool. TCO resets at 275°F (125°C) Check for blocked cooling air. Check for Cooling Fan operation. See Magnetron TCO testing.
<b>Oven will not operate Convection</b>	Convection Heater	Check for line voltage across terminals. See Convection Heater testing.
	Heater Triac	Check power input. See Triac Testing.
	Convection Sensor (RTD) Error Code D0 or D1	See Convection Sensor testing.
	Oven TCO Error Code G0	Allow Oven to cool then reset Oven TCO. See Oven TCO testing.
<b>Stirrer Motor will not operate</b>	Interlock Switches	Check voltage across Stirrer Motor wires. Check Interlock switches if not found.
	Stirrer Motor	See Stirrer Motor testing.
<b>Convection Motor will not operate</b>	Convection Motor	See Convection Motor testing.
	Main Control Board	See Oven Test Mode.
<b>Cooling Fans will not operate</b>	Cooling Fan Motor	See Cooling Fan testing.
	Cooling Fan Relay	See Cooling Fan Relay testing.
	Cooling Fan Run Capacitor	See Fan Run Capacitor testing.
	Cooling Fan Triac	See Cooling Fan Triac testing.

---

# 10 | Component Overview

Testing

Removal and Replacement

## ! IMPORTANT !

FOR YOUR SAFETY

Review ALL Safety Precautions before performing any Component Testing Procedures contained in this section.

## DANGER

- Disconnect Power Supply before removing any Covers or Panels. The high voltages and currents at the filament and secondary winding of the Transformer are extremely dangerous.
- The high voltages and currents at the filament and secondary winding of the transformer are extremely dangerous. Never make any direct voltage or current measurements at these winding. It is very dangerous to work near this part when the oven is on, or even if this circuitry has been switched off.
- All High Voltage Capacitors must be discharged before performing this procedure.

## WARNING

- High voltage capacitor must be discharged before performing these procedures. Wait at least five (5) minutes after shutdown of high voltage system.
- Use extreme caution when working with live circuits.

## CAUTION

- Extreme care must be taken when performing tests with line voltage applied.
- Oven is heavy.

# Panel Removal

## Panel Removal

### DANGER

Disconnect Power Supply before removing any Covers or Panels.

The high voltages and currents at the filament and secondary winding of the Transformer are extremely dangerous.

### Top Panel

1. Remove the eight (8) Screws (4 along top, 2 on each side) using a Phillips Head Screwdriver or 1/4" Hex Socket.
2. Slide Panel towards rear until it disengages with front.
3. Lift off.

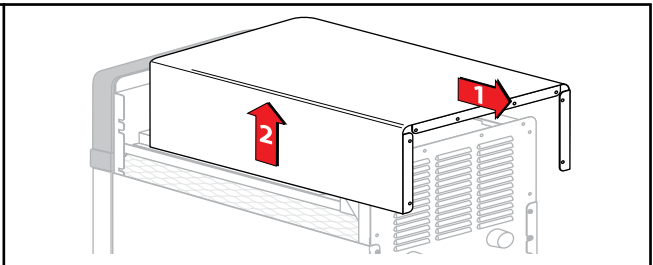
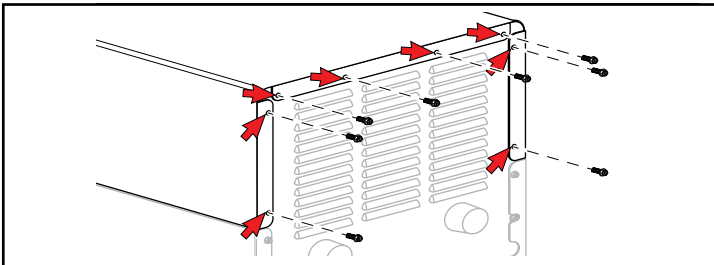

### Side Panels

1. Remove Top Panel.
2. Remove two (2) Screws per side using a Phillips Head Screwdriver or 1/4" Hex Socket.
3. Slide Panel towards rear until it disengages with front.
4. Lift off.

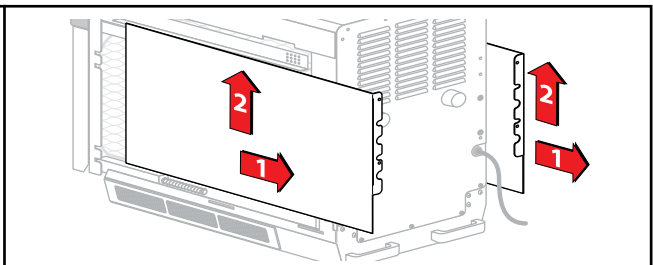
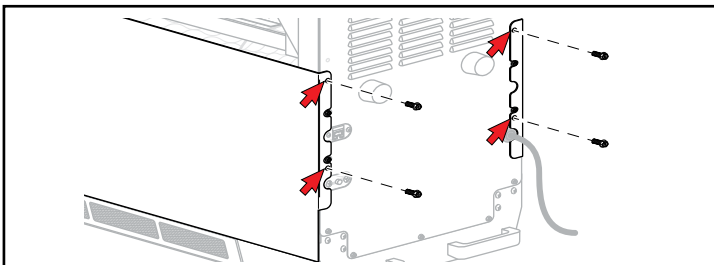

### Rear Panel

1. Remove Top and Side Panels.
2. Remove nine (9) Screws (3 along bottom, 1 on each side) using a Phillips Head Screwdriver or 1/4" Hex Socket.
3. Lift up and out.

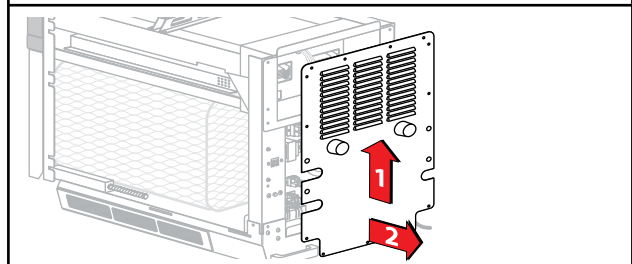
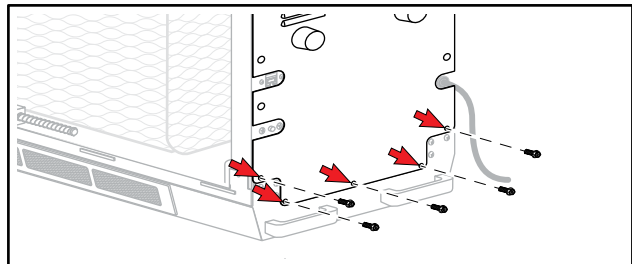

# Rear Exhaust Duct Removal

## Rear Exhaust Duct

The Rear Exhaust Duct directs exhaust air from the Cooling Fans out of the rear of the oven.

## Removal and Replacement

1. Disconnect oven from Power Supply.
2. Remove Top, Right, Left and Rear Panels.  
(see Panel Removal)
3. Because of proximity to HV circuit, discharge all HV Capacitors.
4. Using a 1/4" Hex Socket, remove two (2) Screws from each side where the duct connects to the Magnetrons.
5. From the rear, remove the two (2) Screws connecting the Duct to the Antenna Chamber Duct.
6. Disconnect Wires running through Grommet, making a note of where they connect.
7. Lift out.
8. Replace by reversing these steps.

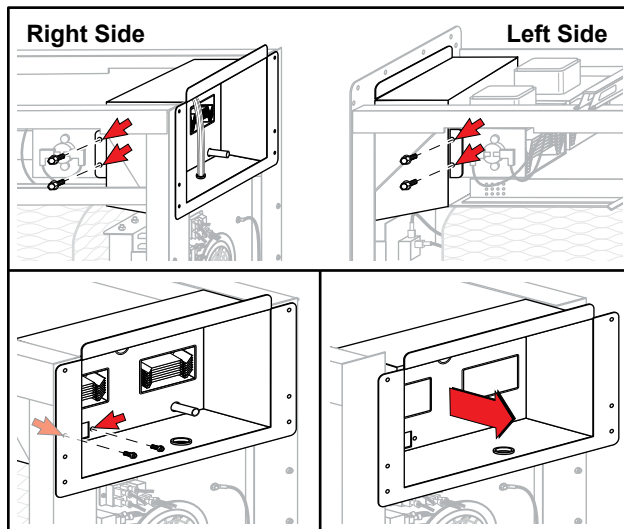

# Oven Thermal Cutout (TCO)

---

## Oven Thermal Cutout (TCO)

The Thermal Cutout or TCO acts as a high-limit to protect the oven from an overheat situation in the cooking cavity.

The TCO is a switching device that will open its contacts at approximately 608°F (320°C).

It is manually reset by a button located in the rear of the oven.

## Testing

---

With oven disconnected from the Power Supply, disconnect the Wires from the device. Check for continuity between Terminals 11 and 12. If oven temperature is below tripping point, and there is no continuity, press the Reset Button. If still no continuity, replace TCO.

## Removal and Replacement

---

1. Disconnect oven from Power Supply.
2. Remove Top, Right, Left and Rear Panels.  
(see Panel Removal)
3. For better access, remove Rear Exhaust Duct.
4. Remove Wires from TCO.
5. Trace Sensor Capillary to top of oven.  
Pull straight up to remove Sensor.
6. Remove two (2) Phillips Head Screws securing TCO.
7. Remove TCO.
8. To replace, reverse these steps.

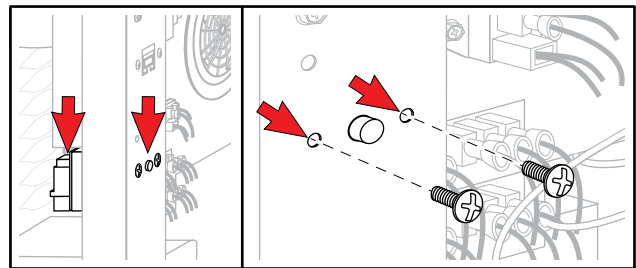

## Triacs

A Triac is an electronic switching device similar to a Relay. Depending on the model, there will be up to four (4) Triacs, one (1) for the Cooling Fans, one (1) for the Heater, and one (1) for each Magnetron circuit.

## Testing

With oven disconnected from the Power Supply, disconnect the Wires from the device. Check resistance between Terminals and each Terminal to Ground:

MT1 to Gate  $\approx 50\Omega$

MT1 to MT2 = Open

MT2 to Gate = Open

All Terminals to Ground = Open

## Removal and Replacement

1. Disconnect oven from Power Supply.
2. Remove Top, Right, Left and Rear Panels.  
(see Panel Removal).

### **DANGER**

**All High Voltage Capacitors must be discharged before performing this procedure.**

3. Discharge all HV Capacitors.
4. Remove all Wires from the device.
5. Remove two (2) Screws securing device.
6. To replace, reverse these steps.

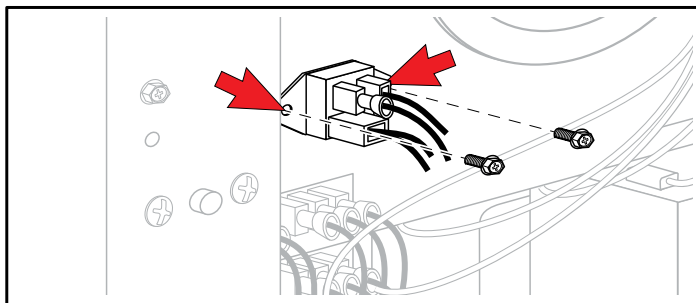

# Autotransformer and Snubber

---

## Autotransformer and Snubber

The Autotransformer circuit provides constant voltage to the Power Board and Cooling Fans. The Snubber is in place to reduce voltage spikes.

## Testing

---

With oven disconnected from the Power Supply, disconnect the Wires from the device.

### Autotransformer:

Check resistance between terminals:

230 to 0 = 38  $\Omega$

208 to 0 = 35  $\Omega$

120 to 0 = 25  $\Omega$  (not used)

All Terminals to Ground = Open

### Snubber:

Continuity – Open

Capacitance – 0.09 $\mu$ f

## Removal and Replacement

---

1. Disconnect oven from Power Supply.
2. Remove Top, Right, Left and Rear Panels (see Panel Removal).
3. Note all Wire locations.
4. Remove all Wires from the device.
5. Remove two (2) Screws securing device.
6. To replace, reverse these steps.

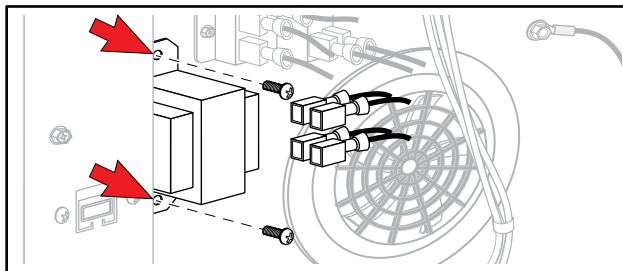

# Cooling Fan Relay (24V)

## Cooling Fan Relay (24V)

The Cooling Fan Relay is a switching device that controls power to the Cooling Fans.

## Testing

With oven disconnected from the Power Supply, disconnect the Wires from the device.

Check resistance across Coil:

RD to BK  $\approx 550 \Omega$  (3/16" terminals)

Check continuity across contacts:

COM to NC = Continuity

COM to NO = Open

## Removal and Replacement

1. Disconnect oven from Power Supply.
2. Remove Top, Right, Left and Rear Panels (see Panel Removal).
3. Note all Wire locations.
4. Remove all Wires from the device.
5. Remove two (2) Screws securing device.
6. To replace, reverse these steps.

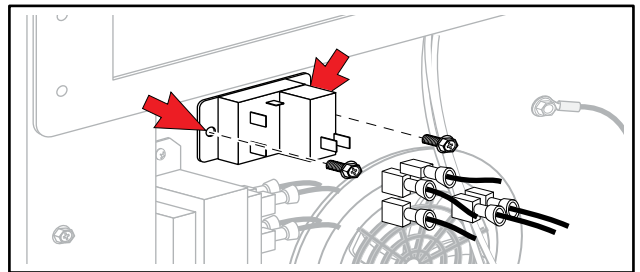

# Power Relay

---

## Power Relay

The Power Relay is a switching device that controls the incoming power to all other components.

## Testing

---

With oven disconnected from the Power Supply, disconnect the Wires from the device.

Check resistance across Coil:

0 to 1  $\approx 550 \Omega$

Check continuity across contacts:

2 to 4 = Open (NO)

6 to 8 = Open (NO)

## Removal and Replacement

---

1. Disconnect oven from Power Supply.
2. Remove Remove Top, Right, Left and Rear Panels (see Panel Removal).
3. Remove Wires from the device noting their locations.
4. For ovens with two (2) Magnetrons, remove one of the HV Transformers for better access. (see HV Transformer Removal and Replacement).
5. Remove two (2) Screws securing device.
6. To replace, reverse these steps.

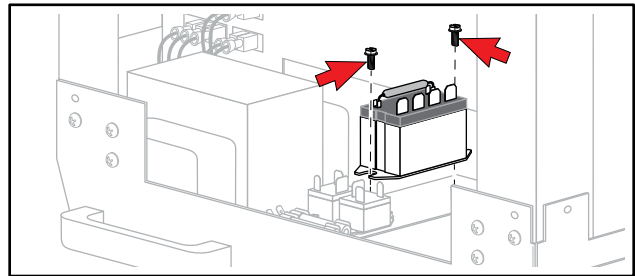

## HV Capacitor

### DANGER

The high voltages and currents at the filament and secondary winding of the transformer are extremely dangerous. Never make any direct voltage or current measurements of this component. It is very dangerous to work near this part when the oven is on, or if this circuitry has been switched off.

### DANGER

All High Voltage Capacitors must be discharged before performing this procedure.

The HV Capacitor is used in the Microwave Circuit to provide the high voltage to supply the Magnetron.

Depending on the model, there may be 1 or 2 HV Capacitors.

## Testing

Capacitance across the Terminals:

0.88 $\mu$ f  $\pm$ 3%

Continuity from each Terminal to the outer case: Open

## Removal and Replacement

1. Disconnect oven from Power Supply.
2. Remove Top, Right, Left and Rear Panels (see Panel Removal).
3. Remove Wire from the device(s) noting their positions.
4. Using a 1/4" Hex Socket, remove the four (4) Screws securing the Mounting Crossbar.
5. Remove the Screws securing the Capacitor(s) to the Crossbar.
6. To replace, reverse these steps.

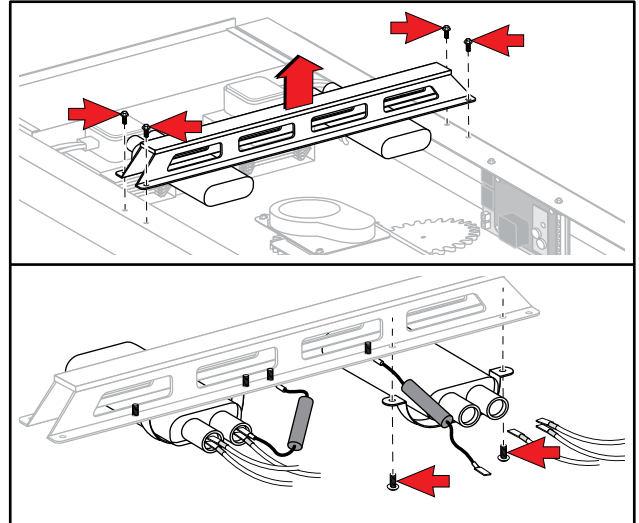

# HV Diode

## HV Diode

### DANGER

The high voltages and currents at the filament and secondary winding of the transformer are extremely dangerous. Never make any direct voltage or current measurements of this component. It is very dangerous to work near this part when the oven is on, or if this circuitry has been switched off.

### DANGER

All High Voltage Capacitors must be discharged before performing this procedure.

The HV Diode is used in the Microwave circuits to provide High Voltage DC to the Magnetron.

## Testing

Remove Diode from Capacitor.

Resistance:

One side to other: Open

Swap Leads:  $\geq 50k\Omega$

**Note: Meter must have  $\geq 6VDC$  battery to measure effectively.**

## Removal and Replacement

1. Disconnect oven from Power Supply.
2. Remove Top Panel (see Panel Removal).
3. Remove Terminal from Capacitor.
4. Remove the Screws securing the Diode(s) to the Crossbar.
5. To replace, reverse these steps.

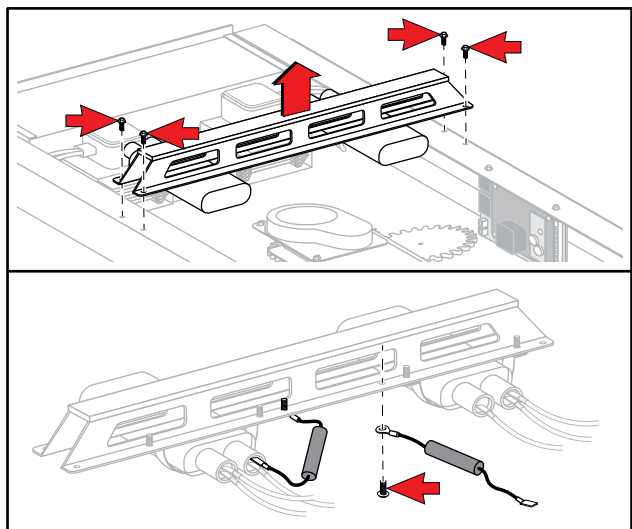

## Magnetron TCO

### DANGER

All High Voltage Capacitors must be discharged before performing this procedure.

The Magnetron TCO protects the Magnetron from an overheat situation.

## Testing

Remove Wires from device.

Across Terminals = Continuity @ < 300°F (320°C)

Opens @ 300°F (149°C)

Resets @ 275°F (125°C)

## Removal and Replacement

1. Disconnect oven from Power Supply.
2. Remove Top and Right or Left Side Panel.  
(see Panel Removal).
3. Remove Wires from device.
4. Remove two (2) Torx-head Screws using a T-15 Driver.
5. To replace, reverse these steps.

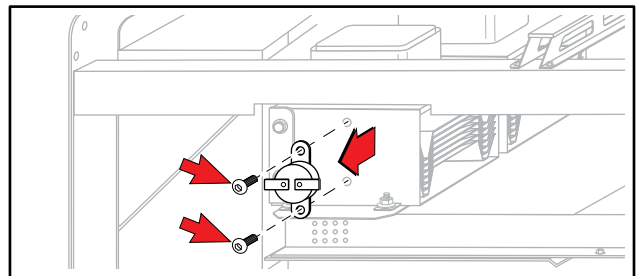

# Magnetron

## Magnetron

### DANGER

The high voltages and currents at the filament and secondary winding of the transformer are extremely dangerous. Never make any direct voltage or current measurements of these circuits. It is very dangerous to work near this part when the oven is on, or if this circuitry has been switched off.

### DANGER

All High Voltage Capacitors must be discharged before performing this procedure.

The Magnetron is a high-powered vacuum tube that generates microwaves.

## Testing

Remove Wires from device.

Resistance:

Terminal to Terminal  $<1\Omega$

Terminal to Chassis = Open

## Removal and Replacement

1. Disconnect oven from Power Supply.
2. Remove Top, Right, Left and Rear Panels. (see Panel Removal).
3. Remove Rear Exhaust Duct. (see Rear Exhaust Duct Removal).
4. Remove Magnetron TCO. (see Magnetron TCO Removal).
5. Remove Wires from device.
6. Remove four (4) Hex Nuts from Mounting Studs using  $11/32"$  (9mm) Socket.
7. Lift Magnetron from Studs.
8. To replace, reverse these steps.

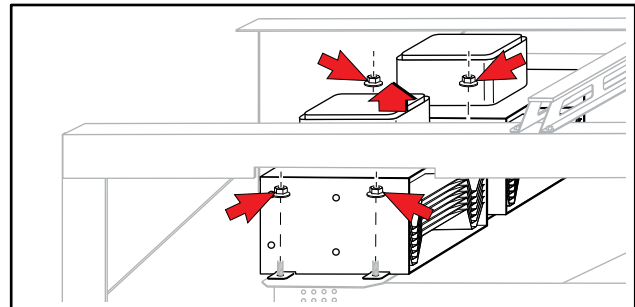

# Stirrer (Antenna) Motor

## Stirrer (Antenna) Motor

The Stirrer Motor rotates the Antenna to scatter the microwaves inside the cooking chamber.

## Testing

Remove Wires from device.

Resistance:

Across Terminals  $\approx 12k\Omega$

## Removal and Replacement

1. Disconnect oven from Power Supply.
2. Remove Top Panel. (see Panel Removal).
3. Remove Wires.
4. Remove three (3) Screws from Mounting Bracket using 1/4" Socket.
5. Remove two (2) Screws from Stirrer Motor using 1/4" Socket.
6. Remove E-Clip from Motor Shaft to remove Drive Gear.
7. To replace, reverse these steps.

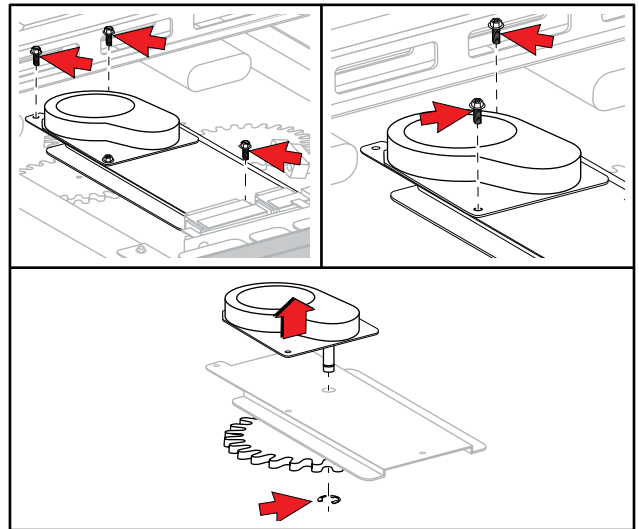

# Wave Guide

## Wave Guide

### DANGER

All High Voltage Capacitors must be discharged before performing this procedure.

The Wave Guide channels the microwaves generated by the Magnetron into the cooking chamber.

## Removal and Replacement

1. Disconnect oven from Power Supply.
2. Remove Top, Right, Left and Rear Panels (see Panel Removal).
3. Discharge HV Capacitors.
4. Remove Rear Exhaust Duct (see Rear Exhaust Duct Removal).
5. Remove Magnetron (see Magnetron Removal).
6. Remove Stirrer Motor (see Stirrer Motor Removal).
7. Remove the Stirrer Motor Mounting bracket by removing four (4) 11/32" (9mm) Hex Nuts. Lift up and out.
8. Remove 11/32" (9mm) Hex Nuts on each side of Wave Guide.
9. Inside the oven, remove the Top Forced Air Plate by removing four (4) Phillips Head Screws in each corner.
10. Loosen, but do not remove, four (4) Phillips Head Screws securing the toggles securing the Microwave Window. Gently pry the Microwave Window down to release the Foam Gasket.
11. Remove the Antenna Gear by first removing the oblong Keeper, then pressing firmly on the Split Shaft with a 1/4" Socket. Lift Gear up and off.
12. From inside the oven chamber, remove the four (4) 1/4" Hex Nuts from around the Antenna.
13. Pull the Antenna down and remove.
14. To replace, reverse these steps.

7

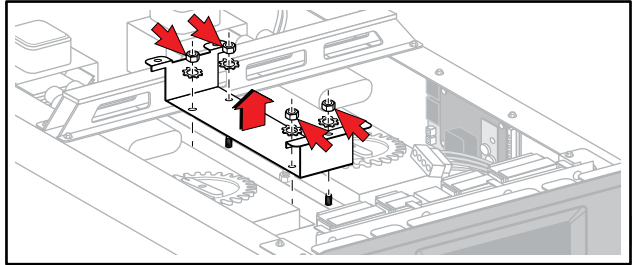

8

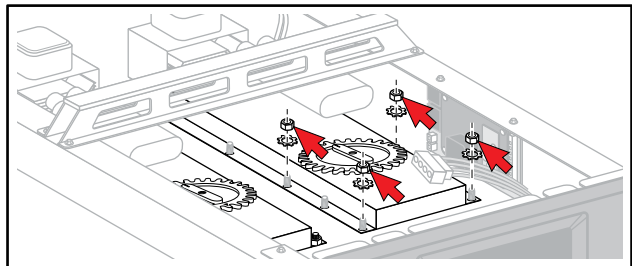

11

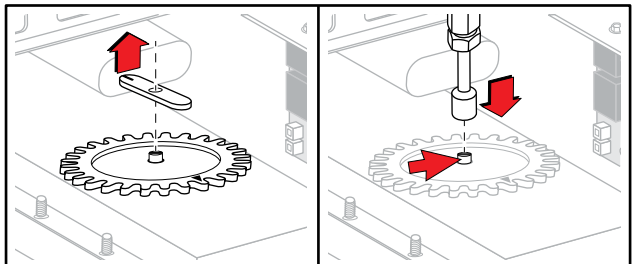

12

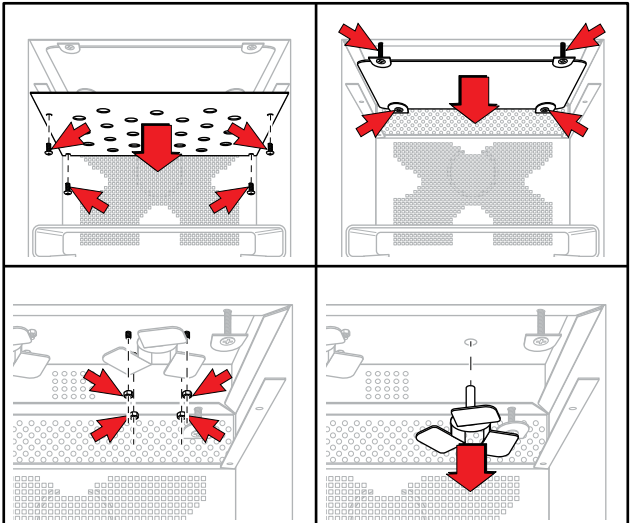

## HV Transformer

### DANGER

The high voltages and currents at the filament and secondary winding of the transformer are extremely dangerous. Never make any direct voltage or current measurements at these winding. It is very dangerous to work near this part when the oven is on, or if this circuitry has been switched off.

### DANGER

All High Voltage Capacitors must be discharged before performing this procedure.

The HV Transformer has 2 purposes. It steps up the line voltage to the high voltage needed to power the Magnetron and it steps down the line voltage to supply the low voltage needed by the Magnetron Filament.

## Testing

Remove Wires from the device.

Resistance:

Com to 208 =  $<2\Omega$

Com to 230 =  $<2\Omega$

5 to 6 =  $<1\Omega$

Com to Ground = Open

208 to Ground = Open

230 to Ground = Open

5 to Ground = Open

6 to Ground = Open

4 to Chassis/Ground  $\approx 62.5\Omega \pm 5\%$

## Removal and Replacement

1. Disconnect oven from Power Supply.
2. Remove top, right, left and rear Panels (see Panel Removal).
3. Discharge HV Capacitors.
4. Remove Wires from device.
5. From the bottom of the oven, remove the four (4) Screws securing the device with a 1/4" Socket.
6. To replace, reverse these steps.

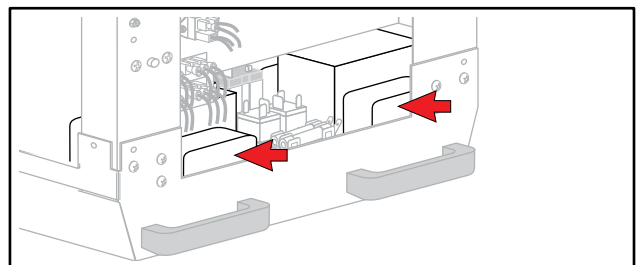

Bottom of Unit

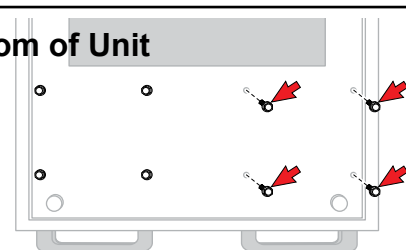

# Primary Interlock Switch

---

## Primary Interlock Switch

The Primary Interlock Switch is a safety device that opens its contacts when the door is opened. It is the first switch to open when the door opens.

## Testing

---

Use Test Plug to check for continuity.

Door Open

BU to RD = Continuity

Door Closed

BU to RD = Open

## Removal and Replacement

---

1. Disconnect oven from Power Supply.
2. Remove Top Panel (see Panel Removal).
3. Remove four (4) Screws securing Control Board Mounting Bracket with 1/4" Socket or Phillips Head Screwdriver, but do not disconnect Wiring. Move Control Board Assembly to provide access.
4. Remove Wires from Switch.
5. Remove two (2) Screws securing Primary Switch to Mounting Bracket using 1/4" Socket or Phillips Head Screwdriver.
6. Replace with Kit (P/N [59174580](#)).
7. Reverse these steps to complete replacement.

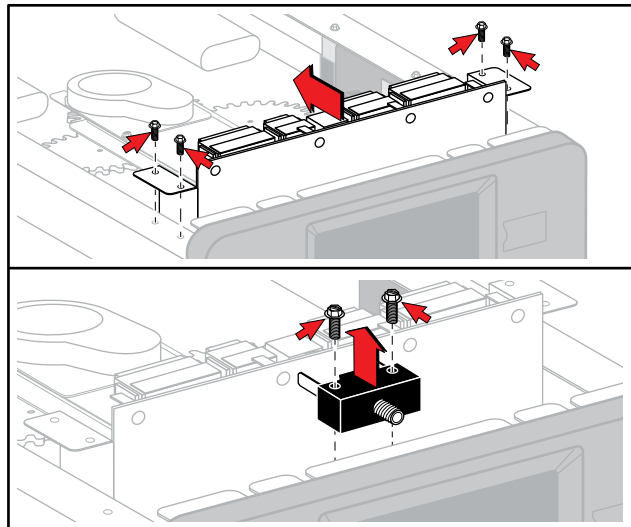

# Secondary, Monitor and Tertiary Interlock Switches

## Secondary, Monitor and Tertiary Interlock Switches

The Secondary, Monitor and Tertiary Interlock Switches are part of a redundant safety system that will turnoff the Microwave Circuit(s) when the door is opened in case of a Primary Switch failure.

### Testing

Use Test Plug on top of oven.

Door Closed:

VT to BU = Open (Monitor)

VT to OR = Continuity (Secondary)

Note: Primary Switch MUST actuate first when opening door.

### Removal and Replacement

1. Disconnect oven from Power Supply.

#### For Secondary and Monitor Switches

2. Remove Top and Right Side Panels.  
(see Panel Removal).
3. Remove 11/32" (9mm) Hex Nut securing Switch Assembly.
4. Lift Bracket off Mounting Stud and slide out.
5. Remove Wires noting their locations.
6. Replace with Kit (P/N [59174580](#)).
7. Reverse these steps to complete replacement.

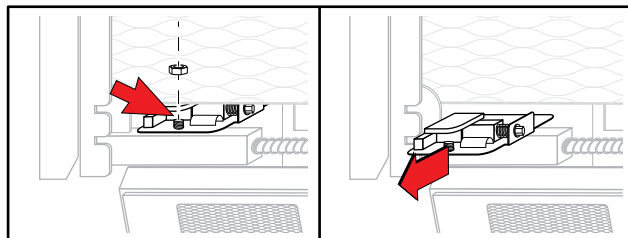

#### For Tertiary Switch

1. Remove Top and Right Side Panels.
2. Remove two (2) Hex Head Screws securing Tertiary Switch.
3. Remove Wires noting their locations.
4. Reverse these steps to complete replacement.

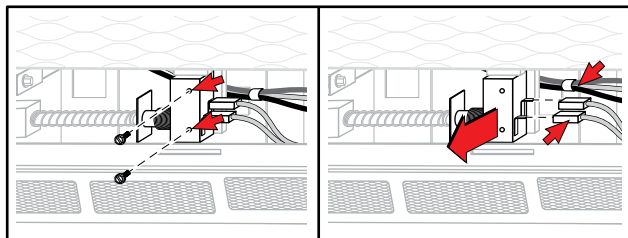

# Power Supply Board

---

## Power Supply Board

The Power Supply Board steps down the incoming line voltage and rectifies it to 24 VDC for the electronics of the oven.

## Testing

---

### CAUTION

Extreme care must be taken when performing tests with line voltage applied.

With line voltage applied:

Voltage:

J1-1 (WH) to J1-3 (BK) = Line Voltage

J2-1 (RD) to J2-5  $\approx$  24 VDC

J2-1 (RD) to J2-6  $\approx$  24 VDC

J2-1 (RD) to J2-7  $\approx$  24 VDC

## Removal and Replacement

---

1. Disconnect oven from Power Supply.
2. Remove Top and Right Side Panels (see Panel Removal).
3. Remove Wire Harnesses from Power Supply Board.
4. Remove two (2) Screws securing Mounting Bracket.
5. Disengage four (4) Retaining Clips securing Power Supply Board.
6. To replace, reverse these steps.

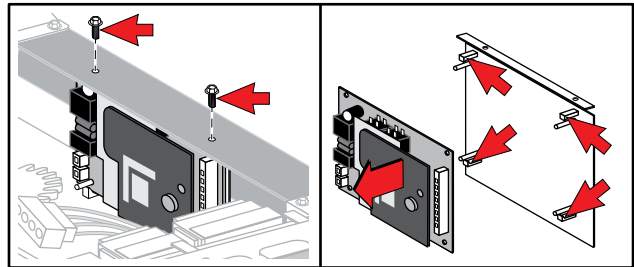

# Main Control Board

## Main Control Board

The Main Control Board is a PCB that controls the functions of the oven.

## Testing

Use the Oven Test Mode.

## Removal and Replacement

1. Disconnect oven from Power Supply.
2. Remove Top Panel (see Panel Removal).
3. Remove four (4) Screws securing Mounting Bracket with 1/4" Socket or Phillips Head Screwdriver.
4. Remove all Wiring Harnesses including Ribbon Harness to Display.
5. Disengage seven (7) Retaining Clips securing Main Control Board.
6. To replace, reverse these steps.

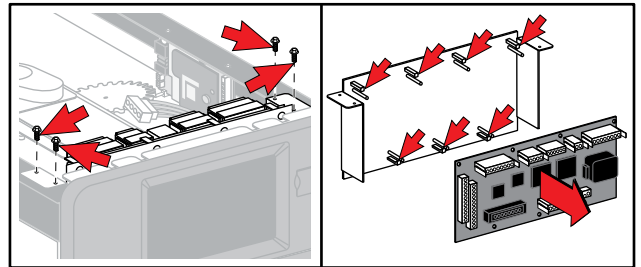

# Touch Screen Display Board

---

## Touch Screen Display Board

The Touch Screen Display Board is the interface by which input to the oven's controls is given by the user and information is output to the display.

## Testing

---

Use the Oven Test Mode.

## Removal and Replacement

---

1. Disconnect oven from Power Supply.
2. Remove Top Panel (see Panel Removal).
3. Remove Main Control Board (see Main Control Board Removal).
4. Remove all Wiring Harnesses from Touch Screen Display Board.
5. Remove four (4) Screws securing Touch Screen Display Board to Mounting Bracket
6. To replace, reverse these steps.

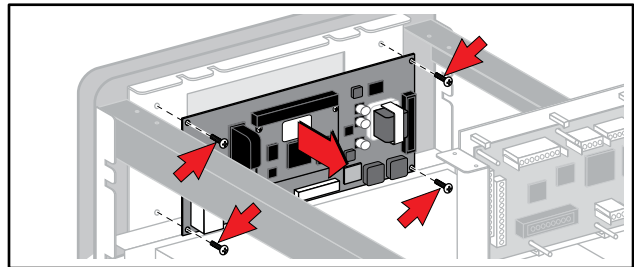

# Temperature Sensor

## Temperature Sensor

The Temperature Sensor (RTD) is a device whose electrical resistance changes with changes in temperature.

## Testing

With Connector Plug disconnected, test for resistance across the two (2) Wires.

@ 70°F (23.9°C) ≈ 1100 Ω

@ 350°F (176.7°C) ≈ 1650 Ω

## Removal and Replacement

1. Disconnect oven from Power Supply.
2. Remove Top Panel (see Panel Removal).
3. Disconnect Connector Plug.
4. Remove two (2) 11/32" (9mm) Hex Nuts securing Temperature Sensor to top of oven.
5. Pull Temperature Sensor up and out to remove.
6. To replace, reverse these steps.

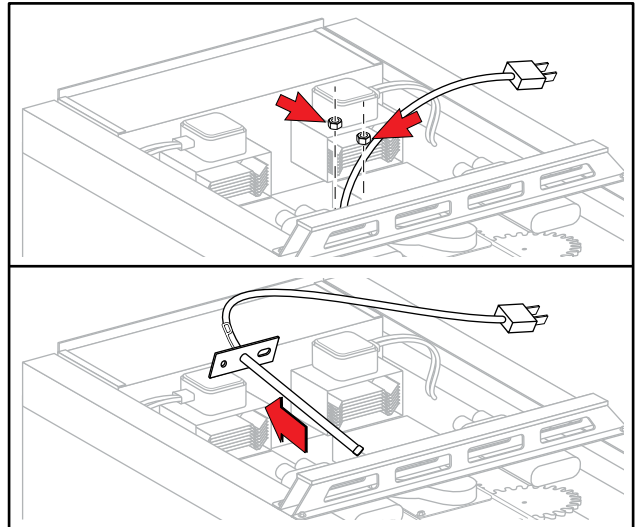

# Convection Motor

## Convection Motor

The convection motor turns a fan that creates the air movement for impingement cooking.

### CAUTION

Extreme care must be taken when performing tests with line voltage applied.

## Testing

Disconnect Connector ST2.

Apply Line Voltage.

Test voltage between ST1-1 and ST1-2

If Line Voltage is present and Motor does not run, replace Motor.

## Removal and Replacement

1. Disconnect oven from Power Supply.
2. Remove Top, Right, Left and Rear Panels (see Panel Removal).
3. Remove Rear Exhaust Duct (see Rear Exhaust Duct Removal).
4. Remove four (4) Screws securing component Mounting Bracket. Remove two (2) Screws joining each half of Bracket. Move each side out of the way. Remove Wires as needed noting their locations.
5. Disconnect Electrical Connectors to Motor.
6. Remove Fiberglass Tape from around perimeter of Mounting Plate.
7. Remove insulation or fold back to expose Mounting Screws around perimeter.
8. Disconnect Wires to Heater.
9. Remove sixteen (16) Screws using 1/4" Socket.
10. Pull the assembly out.
11. The replacement part is an assembly.
  - P/N [59174583](#) (includes Heater)
12. To replace, reverse these steps.

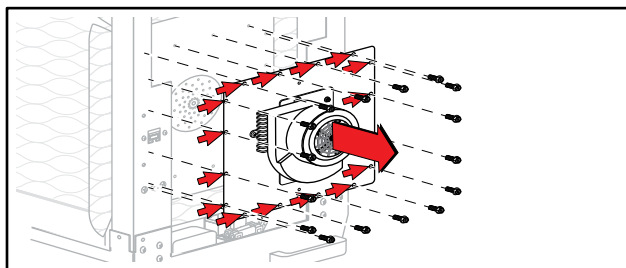
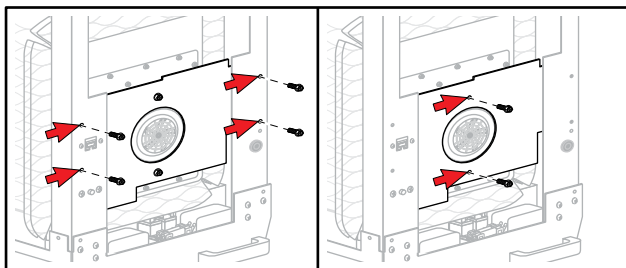

## Heater

The Heater is mounted around the Convection Blower Wheel and heats up the impingement air for the cooking chamber.

## Testing

With the Wires removed test between the two (2) Terminals.

Resistance  $\approx 15 \Omega$

## Removal and Replacement

Follow procedure for Convection Motor Steps 1 – 10

If replacing Heater only:

Add steps:

1. Remove two (2) Hex Head Screws securing Heater Clips to assembly.
2. Remove three (3) Hex Head Screws securing Heater Mount to assembly.
3. Remove Heater from assembly.
  - Replacement Heater (P/N [59174593](#)).
4. Reverse these and Convection Motor steps to complete replacement.

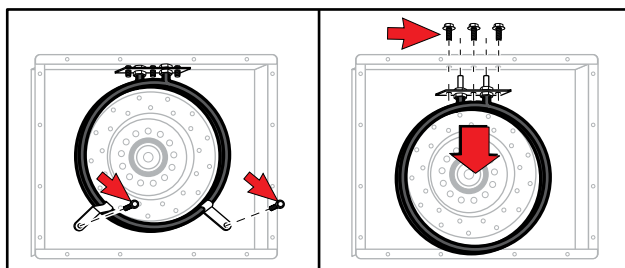

# Cooling Fans

## Cooling Fans

The Cooling Fans draw in ambient air from outside the oven and circulates it through the component compartments to keep them within their operating temperature range.

## Testing

With Connector Plug disconnected check for resistance.

BU to BR  $\approx$  200  $\Omega$

BU to BK  $\approx$  695  $\Omega$

BR to BK  $\approx$  900  $\Omega$

## Removal and Replacement

1. Disconnect oven from Power Supply.
2. Remove Top and Right Side Panels (see Panel Removal).
3. Disconnect Harness Plug to Cooling Fans.
4. Carefully lay oven on left side to access bottom.

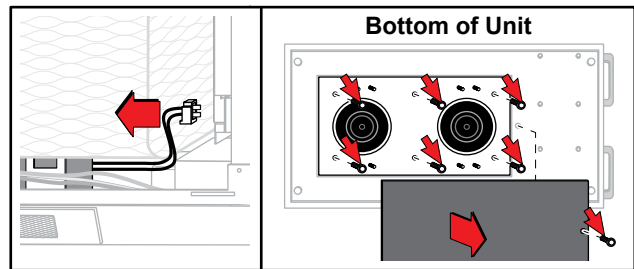

### CAUTION

Oven is heavy.

5. Remove Phillips Head Screw securing Cooling Fan Access Panel. Disengage Panel and remove.
6. Remove six (6) Screws securing Cooling Fan Mounting Plate and pull from oven.
7. Remove Screws (4 per fan) securing Cooling Fan to Mounting Plate and remove Cooling Fan.
8. To replace, reverse these steps.

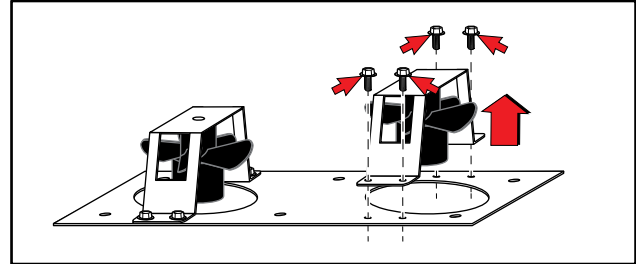

# Cooling Fan Motor Run Capacitors

## Cooling Fan Motor Run Capacitors

The Cooling Fan Motor Run Capacitors alter the current going to the Cooling Fan Motors.

## Testing

Discharge Capacitors. With Wires removed, check for capacitance.

1.5  $\mu\text{f} \pm 5\%$ .

## Removal and Replacement

1. Disconnect oven from Power Supply.
2. Remove Top and Right Side Panels (see Panel Removal).
3. Discharge Capacitors.
4. Remove Wires.
5. Remove Hex Nut with 1/2" (13mm) Wrench.
6. To replace, reverse these steps.

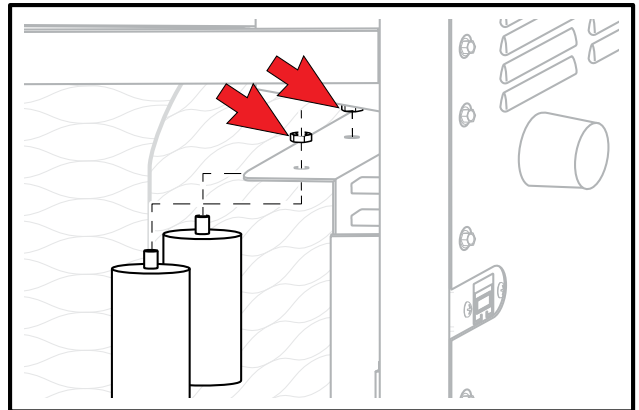

---

# 11 | **Wiring Diagrams / Schematics**

# Wiring Diagrams & Schematics

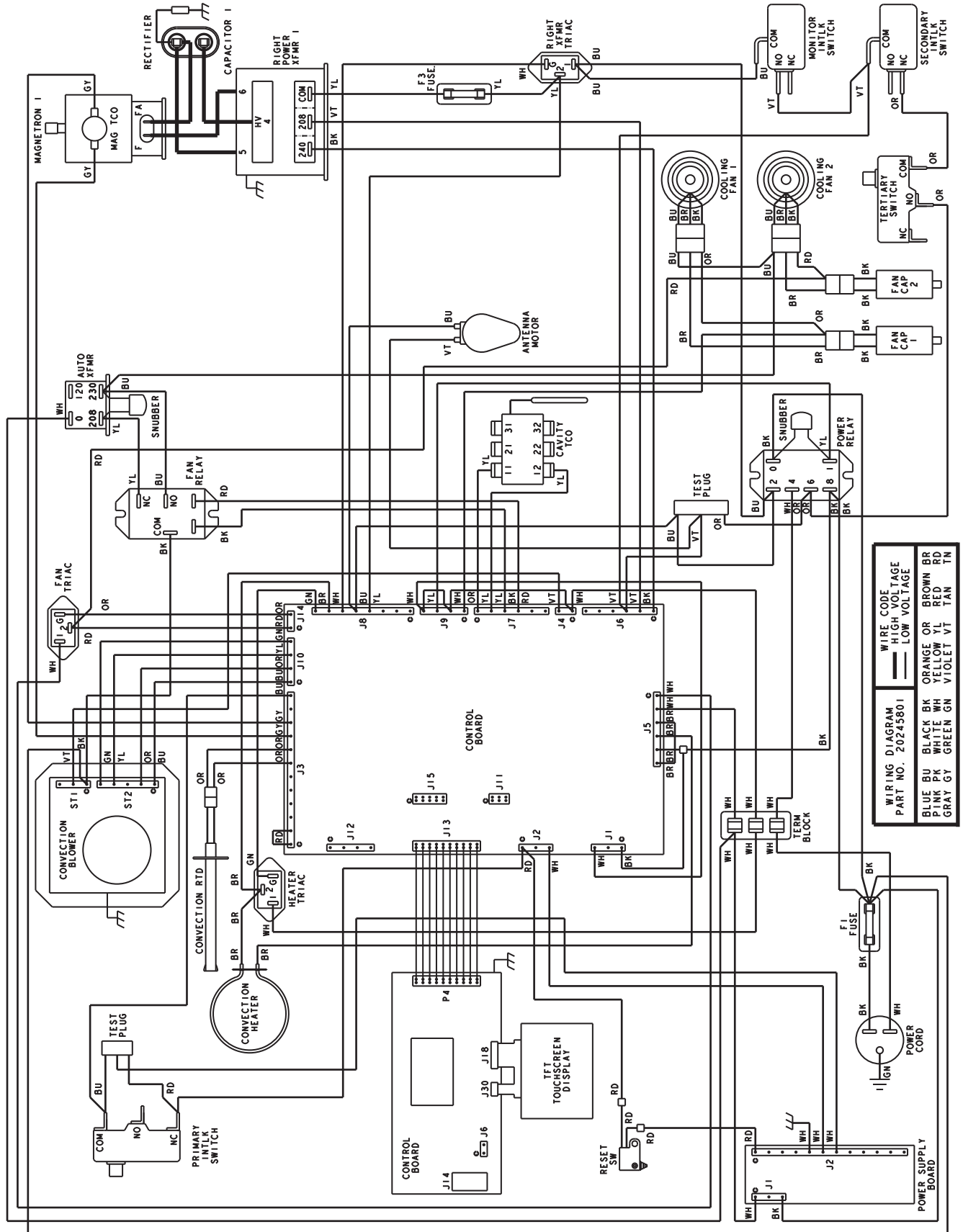

WIRING DIAGRAM PART NO. 20245801	WIRE CODE HIGH VOLTAGE LOW VOLTAGE
BLUE BU	ORANGE OR
PINK PK	BROWN BR
GRAY GY	YELLOW YL
	VIOLET VT
	TAN TN

**ELECTRICAL SCHEMATIC: Models ARX1, ARX1BL, MRX1, MRX1BL**

# Wiring Diagrams & Schematics

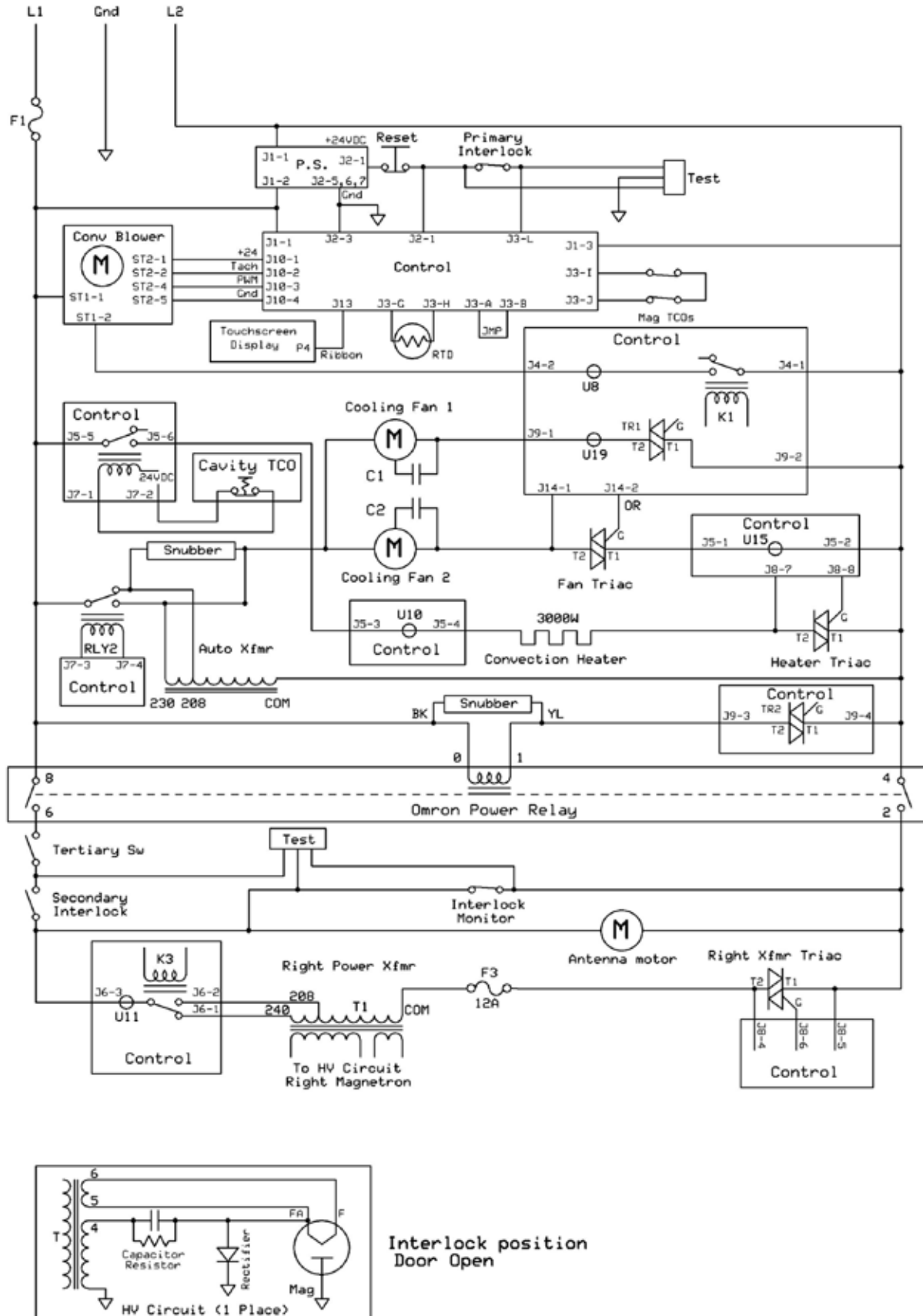

**WIRING DIAGRAM: Models ARX2, ARX2BL, MRX2, MRX2BL**

# Wiring Diagrams & Schematics

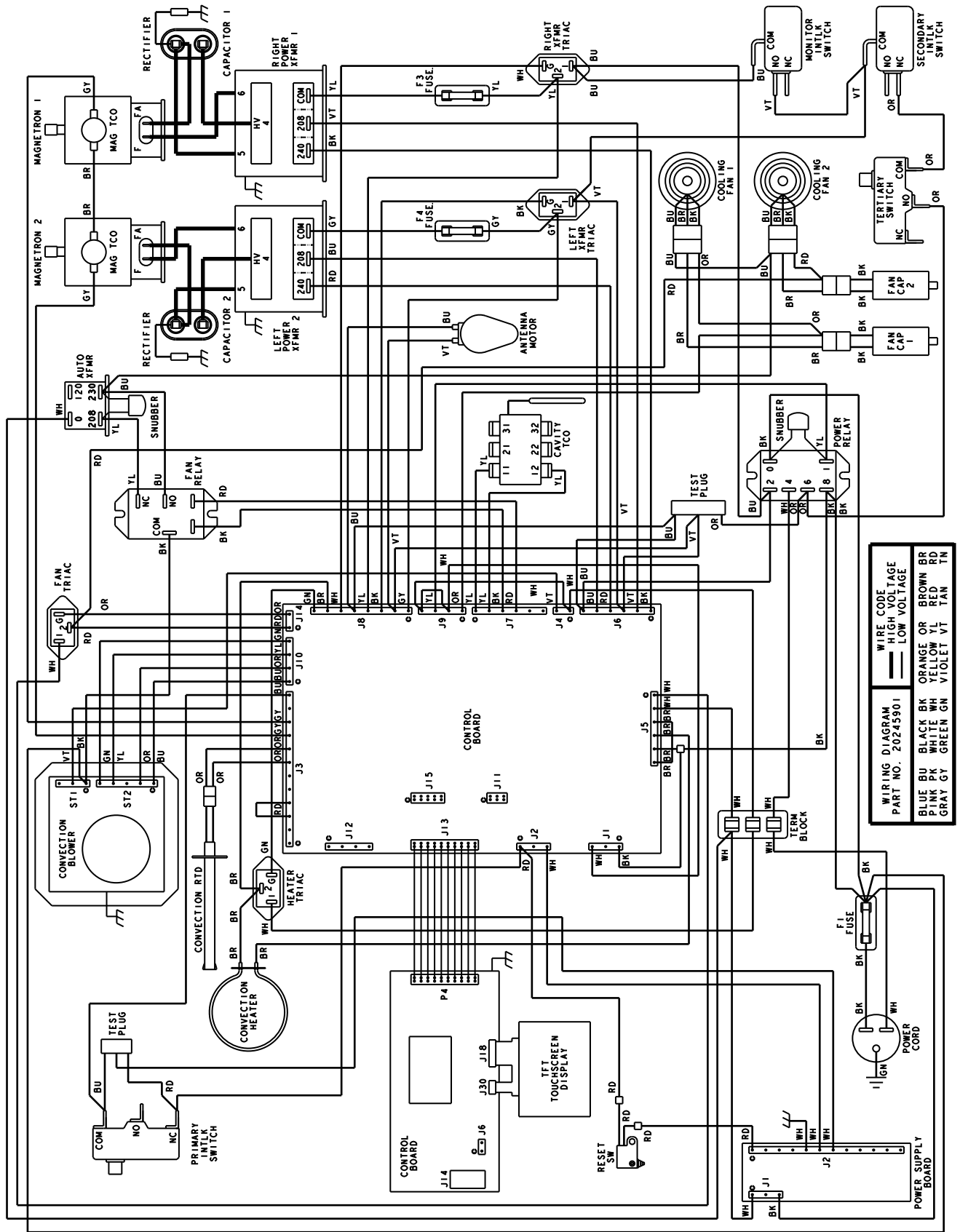

**ELECTRICAL SCHEMATIC: Models ARX2, ARX2BL, MRX2, MRX2BL**

# Wiring Diagrams & Schematics

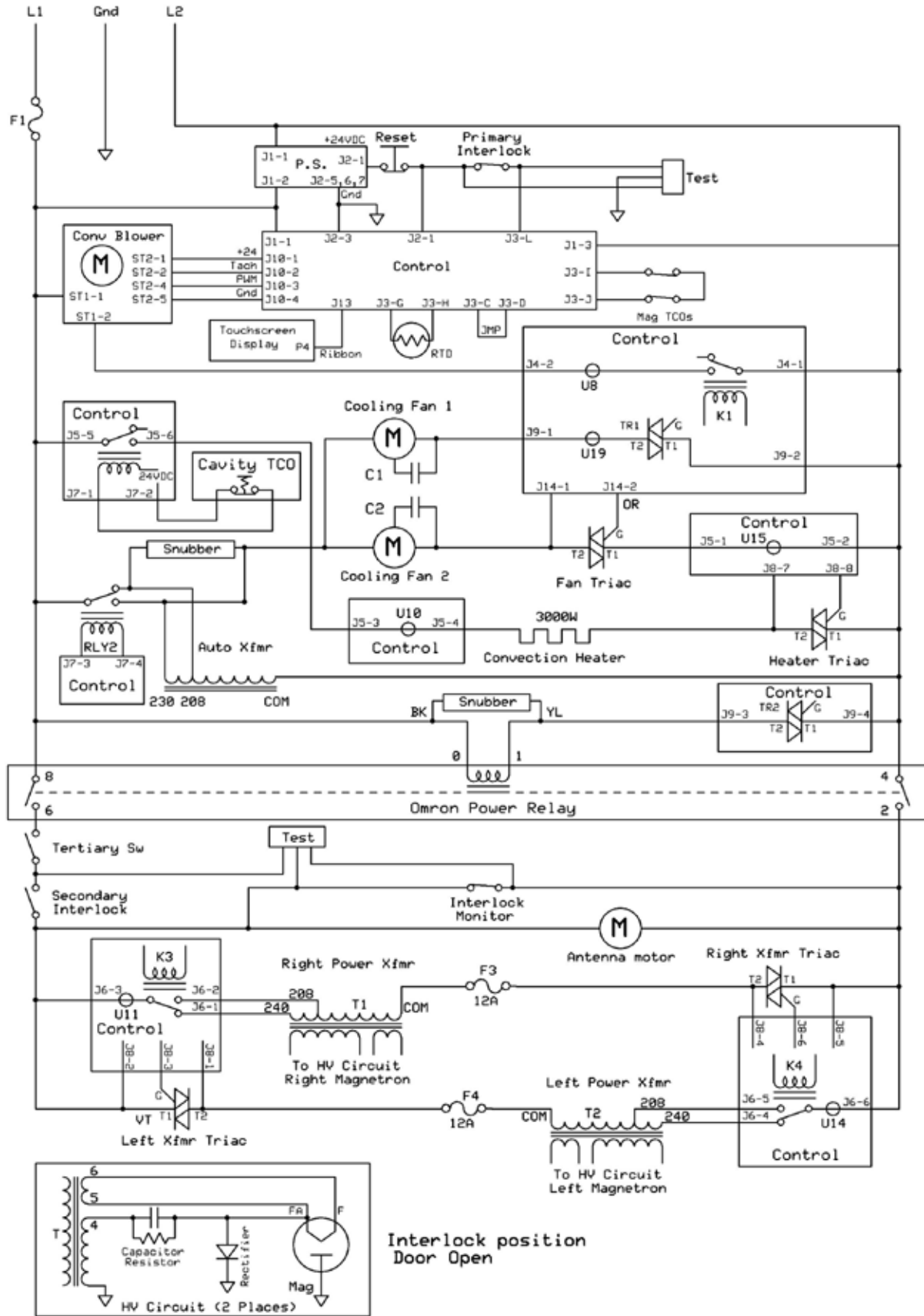

**WIRING DIAGRAM: Models ARX2, ARX2BL, MRX2, MRX2BL**

# Notes

---

# Notes

---

# Notes

---

