

# HURRICILL BLAST CHILLERS & SHOCK FREEZERS

AP3BCF30-1 TS  
AP5BCF45-2 TS  
AP7BCF70-2  
AP7BCF70-2-C  
AP10BCF100-2  
AP12BCF110-3  
AP20BCF200-3  
AP20BC(F)200-2  
AP24BC250-3(-R)  
AP24BCF300-3(-R)

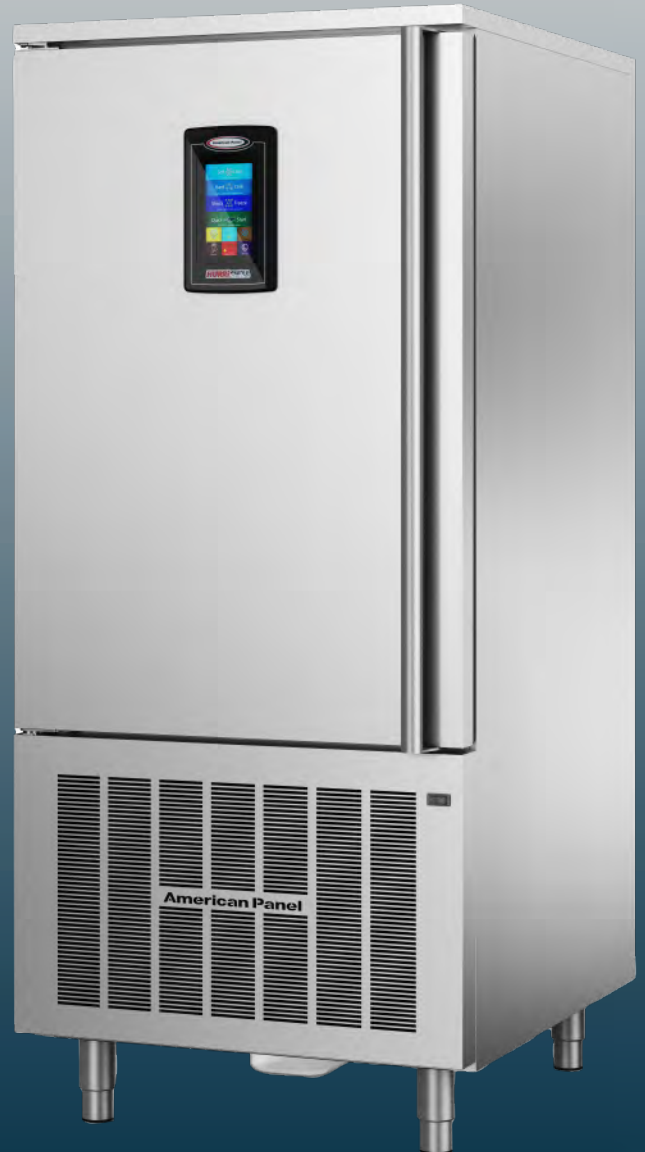

Installation & User's Manual



## TABLE OF CONTENTS

Warranty.....	1
Installation.....	2
Checking for Proper Installation.....	3
Specifications & Performance.....	7
Modes Explained.....	8
Cycles Explained.....	8
- Soft Chill.....	8
- Hard Chill.....	8
- Shock Freeze.....	9
- Defrost.....	9
- Thaw.....	9
- UV Sterilization.....	9
- Heated Probe.....	9
Factory Presets.....	10
Unit Operation.....	11
- Automatic Mode - Any Cycle.....	11
- Manual Mode - Any Cycle.....	12
- A la Carte Mode - Any Cycle.....	13
- Home Screen.....	14
- Automatic Mode Screen Explained.....	15
- Manual Mode Screen Explained.....	16
- A la Carte Screen Explained.....	17
- UV Sterilization.....	18
- Defrost Cycle.....	18
- Heat the Food Probe.....	18
- Download HACCP Data.....	19
- Run a Thaw Cycle.....	19
Customizing the Cycles.....	19
General Operating Instructions.....	19
- PC Communication Package.....	20
- HACCP Download (Peer-to-Peer).....	21
- HACCP Download (via WiFi).....	22
- WiFi Connection.....	23
- Email Configuration.....	26
Maintenance Instructions.....	27
Evaporator Cleaning Procedure.....	28
Parts List.....	29

## WARRANTY STATEMENT

### American Panel Corporation

5800 SE 78th Street  
Ocala, FL 34472-3412

American Panel Corporation products are warranted to the original user installed within the United States and Puerto Rico to be free from defects in materials and workmanship under normal use and service for the applicable period shown in the chart below.

**NOTE: This Warranty does not apply to altered or misused parts.**

<b>WARRANTY COVERS</b>	<b>PARTS</b>	<b>LABOR</b>
Cabinet Assembly	1 year from date of shipment	1 year from date of shipment
Refrigeration Components	1 year from date of shipment	NONE
Refrigeration Compressor	5 years from date of shipment	NONE
Probes & Lights	NONE	NONE

American Panel Corporation agrees to repair or replace at its option, FOB Factory, any part which proves to be defective due to defects in material or workmanship during the warranty period, providing the equipment has been properly installed, maintained and operated in accordance with the HurriChill™ User's Manual. Refer to the above chart for details and exceptions for various equipment items. Labor covered by this warranty must be authorized by American Panel Corporation and performed by a factory authorized service agency.

This warranty does not apply to remote or pre-assembled remote refrigeration systems requiring electrical inter-wiring or refrigerant piping provided by others. In no event shall American Panel Corporation be liable for the loss of use, revenue or profit or for any other indirect, incidental, special or consequential damages including, but not limited to, losses involving food spoilage or product loss. American Panel Corporation reserves the right to withdraw this warranty if it is determined that equipment is not being operated properly. There are no other warranties expressed or implied.

During the warranty period, all requests for service MUST be made before any work is begun. Such requests must be directed to American Panel Corporation Service Department, which will issue written authorization when applicable. Without this authorization, the Warranty may be voided. The service department can be contacted by mail at American Panel Corp., 5800 S.E. 78th Street, Ocala, Florida 34472-3412; or by telephone at 1-800-327-3015; or by fax at (352) 245-0726; or via email at [service@americanpanel.com](mailto:service@americanpanel.com).

**Proper installation is the responsibility of the dealer, the owner-user, or the installing contractor. It is not covered by this Warranty.**

## Installation

---

American Panel Corporation equipment has been shipped in a package designed to sufficiently protect from damage under normal shipping circumstances. Upon receiving the shipment, carefully inspect the package for visible damage and check the number of packages against the Bill of Lading. Notify the carrier immediately of any shortage or damage to your shipment. Claims must be filed promptly with the carrier.

After receipt of shipment, carefully and safely remove the unit from the package. Check the contents of the package against the packing list. Under no circumstances may a damaged piece of equipment be returned to American Panel Corporation without first obtaining written permission.

To assure proper installation carefully read and comply with the following instructions.

**WARNING - Please read the entire installation procedure before attempting to install the unit. Failure to follow the procedures listed in this manual may result in voiding the warranty.**

**IMPORTANT - Due to the size and weight of this equipment, a minimum of two people are required to install this equipment safely. All OSHA regulations must be followed while on the job site.**

## Installation Checklist

- Check the integrity of the unit once it is unpacked.
- On remote refrigeration units only, the cabinet and the condensing unit is shipped with a nitrogen charge, Make sure the charge is still present.
- Check for proper location.
  - Ambient temperature no greater than 90oF (to ensure rated performance)
  - Do not install near heat source
  - Do not install near vapor source
  - Do not install in direct sun light
  - Do not install in closed areas with insufficient air change

- Check for proper clearances

### Reach-In Models:

- 1" clearance on the door handle side of the unit
- 2 ½" clearance on the door hinge side of the unit
- 3" clearance on the back of the unit
- Provide enough space in front to allow door opening
- Check for unobstructed air flow at the condensing unit

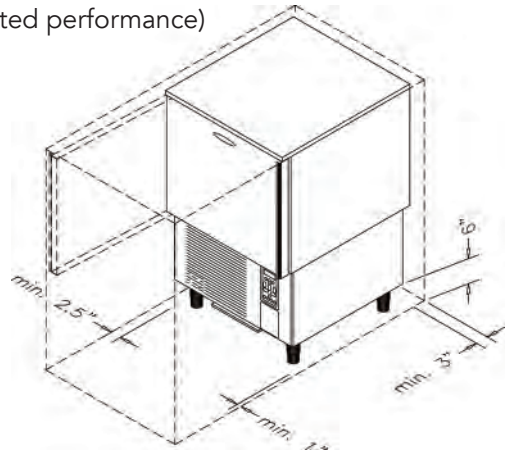

### Roll-In Models:

- 6" clearance on both sides of the unit (for service and door clearance)
- 15" clearance on top of the unit (for service)
- 6" clearance on the back of the unit (for service and drain hook-up)
- Provide enough space in front to allow door opening
- Check for unobstructed air flow at the condensing unit

- Prepare the location.
  - Check that the floor is level
  - Place a layer of water resistant caulk around the perimeter of the entire footprint of the unit (roll-in units only)
  - Place the unit in the chosen location and level it.

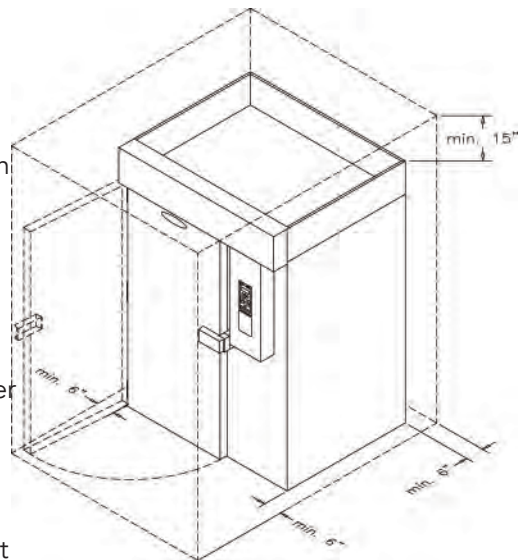

Note: Keep the unit in the upright position at all times. If you must tilt the unit for clearing door ways, do so for a very short period of time. Once in place, keep the unit in upright position for a period of minimum 24 hours prior to powering the unit.

Failure to comply with the above note may cause severe damage to the unit and will void the warranty.

## Installation Checklist (Cont'd)

- Verify the electrical service to be in accordance with the manufacturer label located on the right side of the unit.

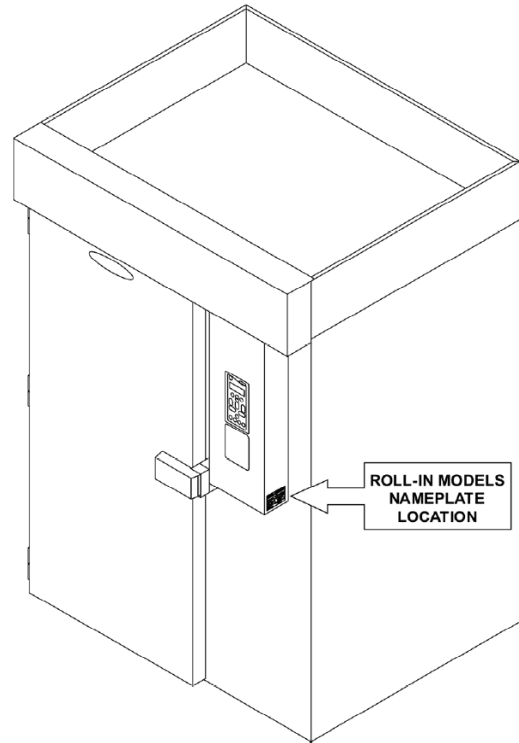

- Connect the unit to the mains.

### Reach-In Models:

- Plug the unit into the wall receptacle

### Roll-In Models:

- Quick disconnect must be provided by the installer in close proximity to the unit
- The electrical connection must be carried out by a licensed electrician
- The electrical J-Box (6 1/4" x 3 1/8") is located on the top of the unit towards the front.
- On remote refrigeration models the cabinet and the condensing unit require separate electrical power supplies.

- Condensate Drainage

### Reach-In Models:

- Install drain pan or drain line. Install the drain pan by sliding the pan on the guides located on the bottom of the unit.
- When installing the drain line the drainage connection must be carried out in conformity with the local regulation. As a standard configuration, all reach-in Hurrichill units are provided with 3/4" ID flexible tubing drain line.

### Roll-In Models:

- The drainage connection must be carried out in conformity with the local regulations.
- As a standard configuration, all roll-in / self-contained Hurrichill units are provided with 1" FPT union at the back of the unit.

- Install wire shelves (if so equipped).

- Operate the unit in Hard Chill / Manual mode for approximately 20 minutes to verify temperature pull down, see chapter Unit Operation – Manual Mode any Cycle.

- Verify proper airflow direction.
  - Evaporator – front to back
  - Condenser – front to back

## Installation Checklist (Cont'd)

---

Note: American Panel Corporation blast chillers are equipped with a short cycle protection. If the unit is stopped or the door is opened and closed during a chilling cycle more than once, the compressor will not start for a period of 3 to 5 minutes.

- Inspect liquid-line sight glass to ensure is clear and dry.
- When possible, inspect the oil level within the compressor, minimum ½ full on level indicator window.
- Engage, operate and verify effectiveness of manually engaged defrost cycle, see chapter Unit Operation – Defrost Cycle.

Note: The blast chiller is programmed, from the factory, to automatically engage the defrost cycle at 12:00 AM every morning. The defrost cycle will not engage unless is needed and the unit is in stand-by mode (no other cycle engaged). To change the time or to disable the automatically engaged defrost cycle see chapter Customizing the Cycles.

- Setup and verify the PC connection (if so equipped), see chapter PC Package. IT personnel may be needed.
- Inform the factory if any functional and performance issues were found following the completion of the above tests.
- Verify that the operator has all necessary operation manuals, menus and instructions. Contact factory with any questions, Monday-Friday 8:00 a.m. to 5:00 p.m. ET at 800-327-3015 or consult the website at [www.americanpanel.com](http://www.americanpanel.com)

## Remote Condensing Unit Installation

THIS SECTION PERTAINS TO UNITS WITHOUT SELF-CONTAINED REFRIGERATION

Follow the condensing unit manufacturer's installation instructions when installing the condensing unit. An installation manual will be provided with the unit.

Check the compatibility of the unit

- Use the chart below to establish compatibility of the refrigeration system. All Hurrichill units are designed for R404A refrigerant

Model	Refrigeration System Type	Capacity [BTU/H] (AT EVAP. TEMP. 14°F AND COND. TEMP 105°F)	Evaporating Temperature [°F]
AP20BC200-2	Medium Temp.	25,000	-10 to 40
AP20BCF200-2	Medium/Low Temp.	25,000	-40 to 40
AP24BC250-3 (-R)	Medium Temp.	25,000	-10 to 40
AP24BCF300-3 (-R)	Medium/Low Temp.	50,000	-40 to 40

### REFRIGERANT CHARGE

Follow the condensing unit manufacturer's installation instructions when charging the refrigeration system. An installation manual will be provided with the condensing unit. Also, read the considerations below.

An approximate charge hold can be found on the manufacturer's label at the cabinet.

When charging the system, run the unit in:

- Hard Cycle, Manual Mode – if the unit is a Blast Chiller only (BC in the model number).
- Shock Freeze Cycle, Manual Mode – if the unit is a Blast Chile Shock Freezer (BCF in the model number)

**Note: The Hard Cycle will cycle the cabinet temperature between 10°F and 20°F for one hour. After 1 hour the unit will switch into the second part of the cycle with higher temperatures. If more than one hour is needed to charge the system, enter the programming mode of the controller and extend the first part of the Hard Cycle/Manual Mode (read the User's Manual for instructions). Do not forget to revert the setting once the charging is complete.**

**Note: Shock Freeze will cycle the unit at -25°F to -15°F for 4 hours.**

**Note: American Panel Corporation blast chillers are equipped with a short cycle protection. If the unit is stopped during a chilling cycle more than once, the compressor will not start for the following 3 to 5 minutes.**

## Specifications & Performance

In blast chilling mode the units are capable of lowering the core temperature of the product from 160°F to 38°F within 90 minutes.

In shock freeze mode the units are capable of lowering the core temperature of the product from 160°F to 0°F within 240 minutes.

Model	Type	Pan Capacity Sheet / Steam	Chilling Capacity (90 Min)	Freezing Capacity (240 Min)
AP3BCF30-1 TS	Blast Chiller/Shock Freezer	0 / 3	30	36
AP5BCF45-2 TS	Blast Chiller/Shock Freezer	0 / 5	45	54
AP7BCF70-2	Blast Chiller/Shock Freezer	7 / 14	100	60
AP7BCF70-2-C	Blast Chiller/Shock Freezer	7 / 7	70	42
AP10BCF100-2	Blast Chiller/Shock Freezer	0 / 10	100	60
AP12BCF110-3	Blast Chiller/Shock Freezer	12 / 24	160	90
AP20BCF200-3	Blast Chiller/Shock Freezer	10 / 20	200	120
AP20BC200-2	Blast Chiller	(1) 26" x 29" x 70" Rack	200	--
AP20BCF200-2	Blast Chiller/Shock Freezer	(1) 26" x 29" x 70" Rack	200	120
AP24BC250-3	Blast Chiller	(1) 27" x 30.5" x 72" Rack	250	--
AP24BCF300-3	Blast Chiller/Shock Freezer	(1) 27" x 30.5" x 72" Rack	300	180
AP24BC250-3-R	Blast Chiller	* - (1) 202 Rational Rack	250	--
AP24BCF300-3-R	Blast Chiller/Shock Freezer	* - (1) 202 Rational Rack	300	180

\* Standard configuration sized for 202 Rational rack. Other combi configurations are available; consult factory.

**NOTE: Each unit was designed for a specific product capacity as shown above. Overloading the unit could significantly reduce the service life of the unit.**

## Modes Explained

---

Each unit is capable of running in one of the following modes:

- In 'Automatic' mode the unit will monitor the food temperature via the food probe and adjust the air temperature accordingly.

**NOTE: When using 'Automatic' mode it is very important to insert the food probe in the product. The food probe must read the core temperature of the product in order for the unit to work as intended.**

- In 'Manual' mode the air within the cabinet will be held at a preset temperature for a preset amount of time based on the selected operating cycle (see below).
- In 'A la Carte' mode the air within the cabinet will be held at a preset temperature until all of the timers expire.

## Cycles Explained

---

There are three different cycles available, they are:

**Soft Chill:** Used for delicate items and salad items. Items with low fat or moisture content such as bakery goods should also use this mode.

**Automatic Mode:** The air temperature will cycle between 28°F and 35°F until the food core temperature has reached 40°F, at this point the blast chiller will switch into holding mode where the air temperature will cycle between 35°F and 42°F until the food is removed from the cabinet and/or the cycle is stopped by the operator.

**Manual Mode:** The air temperature will cycle between 28°F and 35°F for 1.5 hours. After 1.5 hours the unit will switch into holding mode where the air temperature will cycle between 35°F and 42°F until the food is removed from the cabinet and/or the cycle is stopped by the operator.

**A La Carte:** The air temperature will cycle between 28°F and 35°F until all the timers expire, after that the unit will switch into holding mode where the air temperature will cycle between 35°F and 42°F until the cycle is manually stopped by the operator.

**Hard Chill:** Used for all foods. Some freezing on the food surface may occur, especially with thicker products; if this is not acceptable use the 'Soft' cycle as described above.

**Automatic Mode:** The air temperature will cycle between 0°F and 10°F until the food core temperature has reached 60°F (first part of the cycle). After the food core temperature reaches 60°F the air temperature inside the unit will cycle between 28°F and 35°F (second part of the cycle) until the food core temperature has reached 40°F. At this point the blast chiller will switch into holding mode where the air temperature will cycle between 35°F and 42°F until the food is removed from the cabinet and/or the cycle is stopped by the operator.

**Manual Mode:** The air temperature will cycle between 0°F and 10°F for one hour (first part of the cycle). After one hour the air temperature inside the unit will cycle between 28°F and 35°F for another hour (second part of the cycle). At this point the blast chiller will switch into holding mode where the air temperature will cycle between 35°F and 42°F until the food is removed from the cabinet and/or the cycle is stopped by the operator.

**A La Carte:** The air temperature will cycle between 0°F and 10°F until all the timers expire. After that the unit will switch into holding mode where the air temperature will cycle between 35°F and 42°F until the cycle is manually stopped by the operator.

## Cycles Explained (Cont'd)

---

**Shock Freeze:** Use for all freezing needs. When using the Shock Freezing Cycle the ice crystals that form within the product are very small. The quality and the texture of the product is preserved. For that reason, the Shock Freeze Cycle is suitable even for delicate products such as sushi meat and prime meat cuts. Shock Freeze Cycle will give excellent results when used in the process of Ice Cream and Gelato hardening, it will give a smooth texture to the product.

**Automatic Mode:** The air temperature will cycle between -25°F and -15°F until the food core temperature will reach 0°F, at this point the blast chiller will switch into holding mode where the air temperature will cycle between -4°F and 3°F until the food is removed from the cabinet and/or the cycle is stopped by the operator.

**Manual Mode:** The air temperature will cycle between -25°F and -15°F for 4 hours. After 4 hours the unit will switch into holding mode where the air temperature will cycle between -4°F and 3°F until the food is removed from the cabinet and/or the cycle is stopped by the operator.

**A La Carte:** The air temperature will cycle between -25°F and -15°F until all the timers expire, after that the unit will switch into holding mode where the air temperature will cycle between -4°F and 3°F until the cycle is manually stopped by the operator.

**NOTE: At the end of any cycle the unit will switch into holding mode to maintain the food at a specific temperature. However, the unit is not designed to be a refrigerator or holding cabinet. Do not allow the blast chiller to function in holding mode for extended periods of time.**

**Occasional overnight holding is allowed.**

**Defrost Cycle:** Use this mode to defrost the evaporator coil. The defrost cycle must be manually engaged (see controller operation below). Defrost the unit once a day or as needed. Ice build-up can be observed by looking thru the fan grill at the evaporator coil. The factory preset time for the Defrost Cycle is 30 minutes.

**Thaw Cycle (if so equipped):** Use to thaw frozen products. Units equipped with the Thaw feature will be delivered with a special thaw probe, a cordless drill and a sanitary drill bit. Use the cordless drill and sanitary drill bit to provide a hole to probe the frozen product.

**Automatic Mode:** The air temperature will cycle between 42°F and 50°F until the food temperature, as recorded by the thaw probe, will reach 32°F; at this point the blast chiller will switch into holding mode where the air temperature will cycle between 35°F and 42°F until the food is removed from the cabinet and/or the cycle is stopped by the operator.

**Manual Mode:** The air temperature will cycle between 42°F and 50°F for a preset amount of time, set by the operator at the time of starting the cycle. After the cycle time expires, the unit will switch into holding mode where the air temperature will cycle between 35°F and 42°F until the food is removed from the cabinet and/or the cycle is stopped by the operator.

**NOTE: When probing for thaw cycle, use the drill bit to provide a hole in the frozen product.**

**Heated Probe (if so equipped):** Use the Heated Probe feature prior to extracting the temperature probe from the frozen product. Gentle heat will be applied to the food probe for 5 seconds to facilitate the extraction of the probe. The Heated Probe will run only if the temperature at the food probe is below 30°F. Repeat the heated probe cycle if needed.

## Factory Presets

### FACTORY PRESETS AUTOMATIC MODE - QUICK REFERENCE CHART

Setting Cycle	Low Air Part 1	High Air Part 1	Breaking Temp.	Low Air Part 2	High Air Part 2	End Food Temp.	Low Air Holding	High Air Holding
Soft	28°F	35°F	NA	NA	NA	40°F	35°F	42°F
Hard (Chillers Only)	10°F	20°F	60°F	28°F	35°F	40°F	35°F	42°F
Hard (Chillers/ Freezers)	0°F	10°F	60°F	28°F	35°F	40°F	35°F	42°F
Shock Freeze	-25°F	-15°F	NA	NA	NA	0°F	-4°F	3°F
Thaw	42°F	50°F	NA	NA	NA	32°F	35°F	42°F

### FACTORY PRESETS MANUAL MODE - QUICK REFERENCE CHART

Setting Cycle	Low Air Part 1	High Air Part 1	Time Part 1	Low Air Part 2	High Air Part 2	Time Part 2	Low Air Holding	High Air Holding
Soft	28°F	35°F	NA	NA	NA	90 MIN	35°F	42°F
Hard (Chillers Only)	10°F	20°F	60 MIN	28°F	35°F	60 MIN	35°F	42°F
Hard (Chillers/ Freezers)	0°F	10°F	60 MIN	28°F	35°F	60 MIN	35°F	42°F
Shock Freeze	-25°F	-15°F	NA	NA	NA	240 MIN	-4°F	3°F
Thaw	42°F	50°F	NA	NA	NA	Set at Start	35°F	42°F

# Unit Operation

## Start any Cycle in Automatic Mode

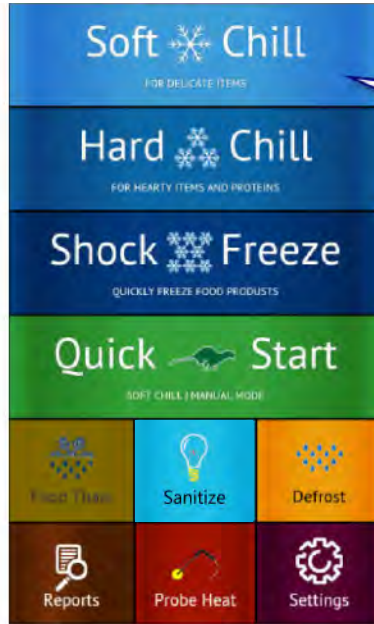

Choose Soft Chill, Hard Chill, or Shock Freeze

Make sure Auto tab is selected

Press to assign Food ID to probe (Optional)

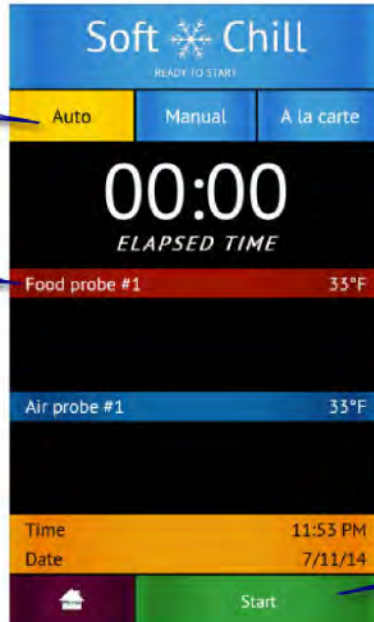

For the Auto mode to work as intended the food probe must be inserted into the product!

Press to start cycle

## Start any Cycle in Manual Mode

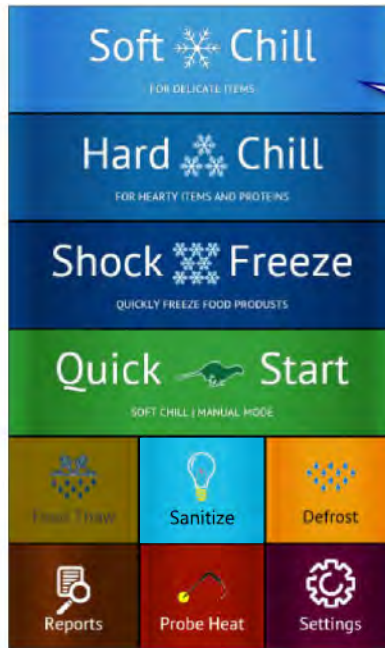

Choose Soft Chill, Hard Chill, or Shock Freeze

Select the Manual tab

Press Up or Down button to adjust the cycle time (Optional)

Press to assign Food ID to probe (Optional)



Press to start cycle

# Unit Operation (Cont'd)

## Start any Cycle in A la Carte Mode

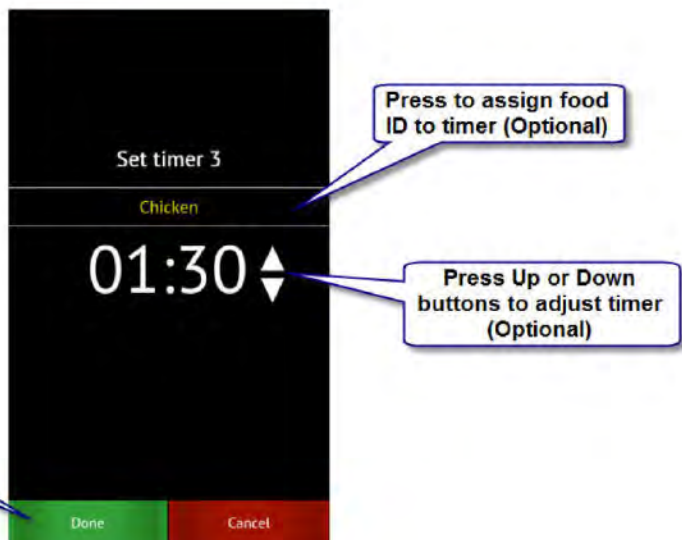
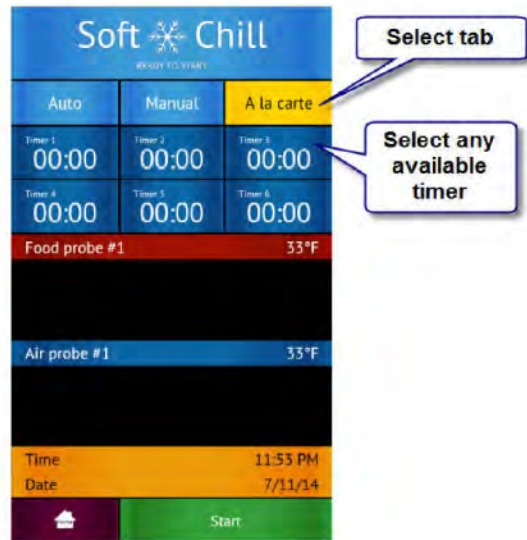

## Unit Operation (Cont'd)

### Home Screen

The home screen can be accessed by tapping on the blank display, if the display is off, or by pressing the home button, if the controller is in one of the cycle screens.



- ① Soft Chill Button – Press to access Soft Chill Cycle Menu
- ② Hard Chill Button – Press to access Hard Chill Cycle Menu
- ③ Shock Freeze Button – Press to access Shock Freeze Cycle Menu
- ④ Quick Start Button – Press to engage the preset cycle, the Quick Start Button is set from the factory to engage the Soft Chill cycle in Manual Mode. The operator can set the Quick Start Button to engage the desired cycle, see Settings → Quick Start.
- ⑤ Food Thaw Button – Press to access Food Thaw Cycle Menu. Food Thaw Cycle is an optional cycle and is available on selected models only.
- ⑥ Sanitize Button – Press to access the Sterilize Cycle Menu. Sterilize Cycle is optional and is available on selected models only. Sterilize Cycle will sterilize the interior of the cabinet. Sterilize Cycle can be set to engage automatically at preset times of the day when unit not in use, see Settings → Sterilize.
- ⑦ Defrost Cycle Button – Press to access the Defrost Cycle Menu. Defrost Cycle can be set to engage automatically at preset times of the day when unit not in use, see Settings → Defrost.
- ⑧ Reports Button – Press to access the HACCP reports preview menu.
- ⑨ Probe Heat Button – Press to choose which food probe to heat for easier extraction from the frozen product.
- ⑩ Settings Button – Press to access the settings menu.

### Automatic Mode Screen

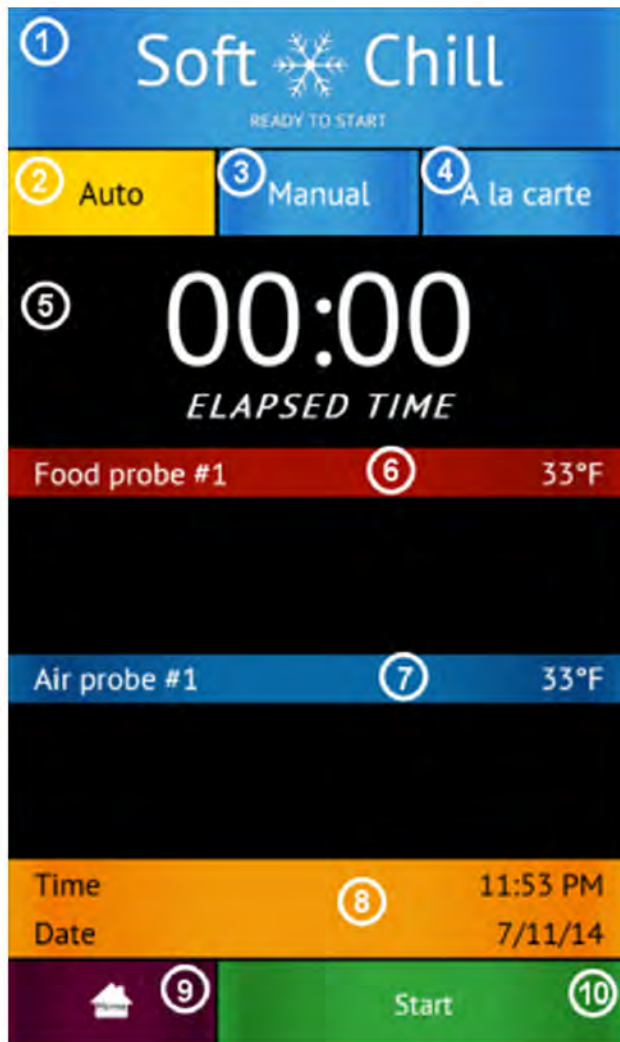

① Status Label – Displays the selected cycle and the status of the cycle.

Status:

“READY TO START” – unit in standby mode waiting for the user to make a selection such as Start

“CYCLE IN PROGRESS” – the chilling cycle is in progress

“COMPLETED” – the chilling cycle has been completed and the unit is maintaining the product at safe holding temperatures

② Auto Mode Button – Press to select the automatic blast chilling mode.

③ Manual Mode Button – Press to switch to the manual blast chilling mode.

④ A la carte Mode Button – Press to switch to the A la carte blast chilling mode.

⑤ ELAPSED TIME Label – Displays the elapsed time from the start of the cycle.

⑥ Food probe #... Label/Button – Press to assign to the current probe the food ID that it monitors. The assigned food ID will show on the HACCP reports. The label of Food probe #... will display the temperature of the probe. One food probe is the standard configuration for all American Panel Corporation blast chillers, the controller supports up to 4 food probes.

⑦ Air probe #... Label – Displays the air temperature inside the cabinet. Double and triple depth cabinet models will have two and three air probes respectively, one for each cabinet.

⑧ Time and Date Label – Displays the current date and time.

⑨ Home Button – Press to stop the current cycle and switch to the home screen.

⑩ Start/Stop Button – Press to start or stop the cycle. If the stop button will be pressed during the cycle a confirmation screen will prompt the user to confirm the choice.

## Unit Operation (Cont'd)

### Manual Mode Screen

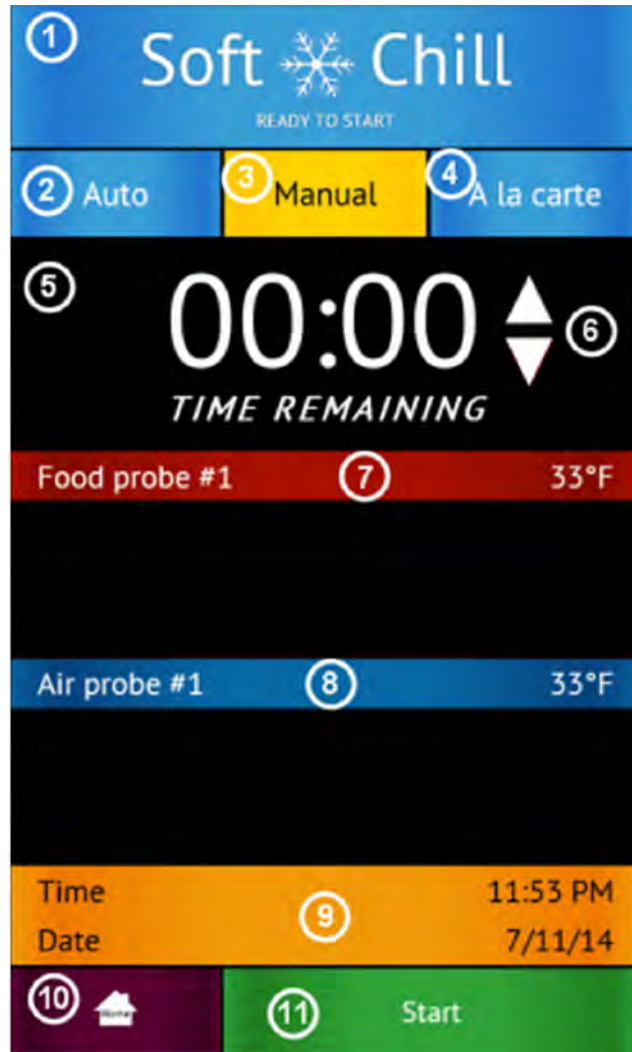

① Status Label – Displays the selected cycle and the status of the cycle  
Status:

“READY TO START” – unit in standby mode waiting for the user to make a selection such as Start

“CYCLE IN PROGRESS” – the chilling cycle is in progress

“COMPLETED” – the chilling cycle has been completed and the unit is maintaining the product at safe holding temperatures

② Auto Mode Button – Press to select the automatic blast chilling mode.

③ Manual Mode Button – Press to switch to the manual blast chilling mode.

④ A la carte Mode Button – Press to switch to the A la carte blast chilling mode.

⑤ TIME REMANING Label – Indicates the remaining time to the end of the cycle.

⑥ UP/DOWN BUTTONS – Press to adjust the cycle time as needed.

⑦ Food probe #... Label/Button – Press to assign to the current probe the food ID that it monitors. The assigned food ID will show on the HACCP reports. The label of Food probe #... will display the temperature of the probe. One food probe is the standard configuration for all American Panel Corporation blast chillers, the controller supports up to 4 food probes.

⑧ Air probe #... Label – Displays the air temperature inside the cabinet. Double or triple depth cabinet models will have two or three air probes respectively, one for each cabinet.

⑨ Time and Date Label – Displays the current date and time.

⑩ Home Button – Press to stop the current cycle and switch to the home screen.

⑪ Start/Stop Button – Press to start or stop the cycle. If the stop button will be pressed during the cycle a confirmation screen will prompt the user to confirm the choice.

## Unit Operation (Cont'd)

### A la Carte Mode Screen



### Set Timer Screen

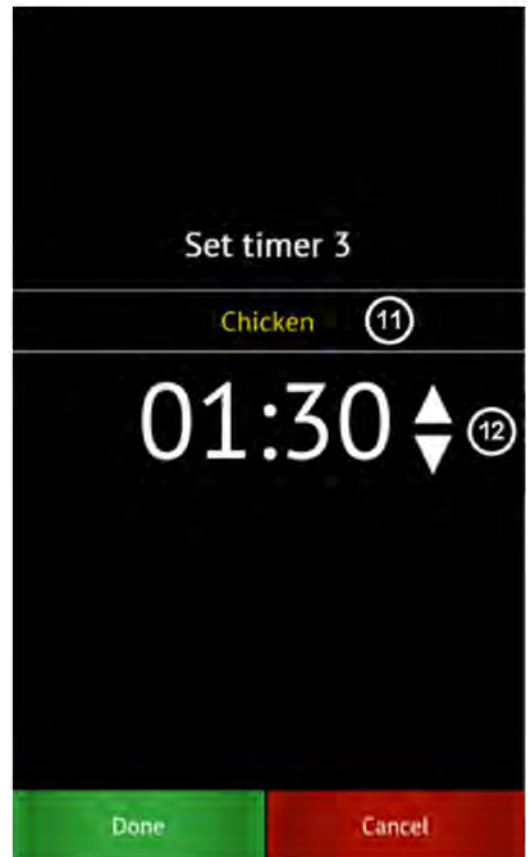

① Status Label – Displays the selected cycle and the status of the cycle

Status:

“READY TO START” – unit in standby mode waiting for the user to make a selection such as Start

“CYCLE IN PROGRESS” – the chilling cycle is in progress

“COMPLETED” – the chilling cycle has been completed and the unit is maintaining the product at safe holding temperatures

② Auto Mode Button – Press to select the automatic blast chilling mode.

③ Manual Mode Button – Press to switch to the manual blast chilling mode.

④ A la carte Mode Button – Press to switch to the A la carte blast chilling mode.

⑤ Timer Buttons/Labels – Press to access the timer setting screen. The timer label will indicate the remaining time and the product name of the food it monitors.

⑥ Food probe #... Label - The label of Food probe #... will display the temperature of the probe. One food probe is the standard configuration for all American Panel Corporation blast chillers, the controller supports up to 4 food probes.

⑦ Air probe #... Label – Displays the air temperature inside the cabinet. Double or triple depth cabinet models will have two or three air probes respectively, one for each cabinet.

⑧ Time and Date Label – Displays the current date and time.

⑨ Home Button – Press to stop the current cycle and switch to the home screen.

⑩ Start/Stop Button – Press to start or stop the cycle. If the stop button will be pressed during the cycle a confirmation screen will prompt the user to confirm the choice.

⑪ Set Timer Id Button – Press to assign a food id. to the current timer.

⑫ Up/Down Buttons – Press to adjust the timer.

## Unit Operation (Cont'd)

---

### Run a Sanitization Cycle

---

From the home screen, press the 'Sanitize' button.

Press the 'Start' button to begin the cycle

NOTE: The unit is programmed from the factory to auto engage the sanitization cycle at 1:00AM every morning. The cycle will not engage unless the door is closed. To change or disable see the section on custom cycles.



### Run a Defrost Cycle

---

From the home screen, press the 'Defrost' button to choose the Defrost Cycle.

Press the 'Start' button to begin the cycle

NOTE: The unit is programmed from the factory to auto engage the defrost cycle at 12:00 AM every morning the defrost cycle will not engage unless it is needed and the unit is in standby mode. To change or disable see the section on custom cycles.



### Heat the Food Probe to Remove from Frozen Product (if so equipped)

---

From the home screen, press the 'Probe' button to engage the heated probe.

Press the 'Start' button to heat the probe.

Remove the probe from the frozen product. Repeat the step above as required until the probe can easily be removed.



## Unit Operation (Cont'd)

---

### Download HACCP Data on USB Drive

---

Insert the USB flash drive into the USB connector.



### Run a Thaw Cycle (Automatic/Manual)

---

From the home screen, press the 'Food Thaw' button.

Press the 'Auto' or 'Manual' tab. The unit will then await the operator to press start.



Press the 'Start' button to begin the cycle.

## Customizing the Cycles

---

The blast chilling and shock freezing cycles have been designed to deliver optimum chilling / freezing performance for most food products. If need be, all the cycles can be customized.

1. From the Home Screen press the Settings button
2. When prompted enter the access code "4444"
3. In the Settings menu choose the cycle to customize.
4. Adjust the parameters and press done to exit.

## General Operating Instructions

---

### Panning and Loading

---

Follow the methods below for faster cooling, freezing and thawing:

- Place the food in shallow pans.
- Do not use food pans deeper than 2 ½" and do not fill the pan with more than 2" of product.
- Separate the food in smaller or thinner portions.
- Do not cover the containers unless danger of overhead contamination.
- Loosely cover the containers if necessary. Allow the cover material (aluminum foil...) to touch the surface of the food.
- Arrange the pans for optimum air circulation within the cabinet.
- Know the capacity of the unit. Do not overload the unit.

### Probing (for Chilling & Freezing Cycles)

---

Follow the methods below to ensure correct probing of the product:

- Insert the food probe into the thickest part of the product.
- The tip of the food probe will have to be located at the core of the food.
- Always place the available food probe in the hardest to cool product.
- It is a good practice to restart the cycle every time food is added.
- Clean and sanitize the food probe after each use.

## **Unit Operation (Cont'd)**

---

### **Probing (for Thaw Cycle)**

---

Follow the methods below to ensure correct probing of the product:

- Use the provided drill and drill bit to drill a hole into the frozen product.

## **PC Package**

---

### **PC Communication Package**

---

The optional wireless pc communication package features:

- HACCP data download via local Wi-Fi network or peer-to-peer connection
- Remote blast chiller monitoring via Wi-Fi network
- E-mail notifications

## Unit Operation (Cont'd)

### HACCP Data Download - Peer-to-Peer

If the blast chiller is equipped with the PC Communication Package, then the controller is set from the factory as a Wi-Fi access point. In this configuration the controller broadcasts an SSID such as blast-chiller-xxxxxxxxxx-wha.

To connect your Wi-Fi enabled device to the blast chiller controller do the following:

1. Open the Wi-Fi connections on your device
2. Connect to the SSID blast-chiller-xxxxxxxxxx-wha
3. Open your web browser and enter the following in the address bar: 192.168.1.1
4. If the blast chiller is in stand-by mode the home screen should appear on the screen of your device

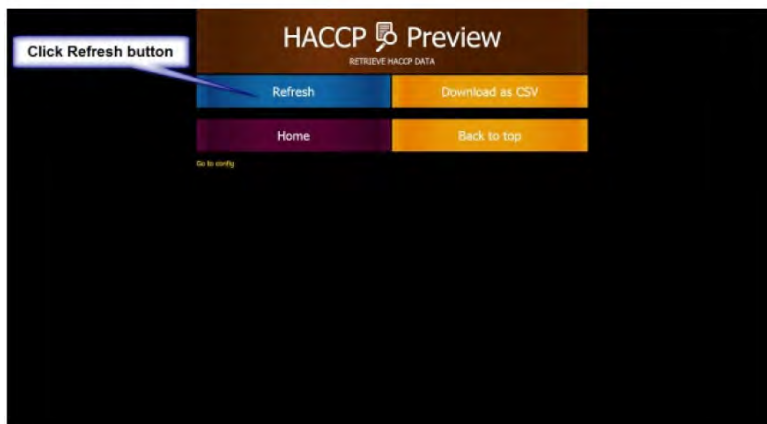

## Unit Operation (Cont'd)

### HACCP Data Download via Wi-Fi network

1. Make sure the blast chiller controller is connected to a Wi-Fi network. See blast chiller controller setup for instructions on connecting to a WiFi network.
2. Open the web browser on a device that is connected to the same Wi-Fi network
3. In the address bar enter the IP address for the blast chiller or retrieve from favorites, see "Blast Chiller Controller Setup for Wi-Fi Network Connectivity".

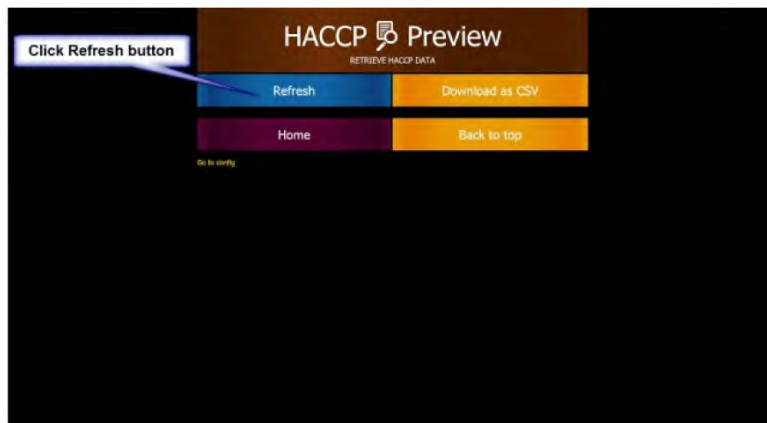

## Unit Operation (Cont'd)

### Blast Chiller Controller Setup for Wi-Fi Network Connectivity

1. Connect your Wi-Fi enabled device to the blast chiller controller:
  - a. Open the Wi-Fi connections tray
  - b. Connect to the SSID blast-chiller-xxxxxxxxxxx-wha
  - c. Open your web browser (Chrome is recommended) and enter the following in the address bar: 192.168.1.1
  - d. If the blast chiller is in stand-by mode the home screen should appear on the screen of your device
2. Configure the controller to connect to the Wi-Fi network:

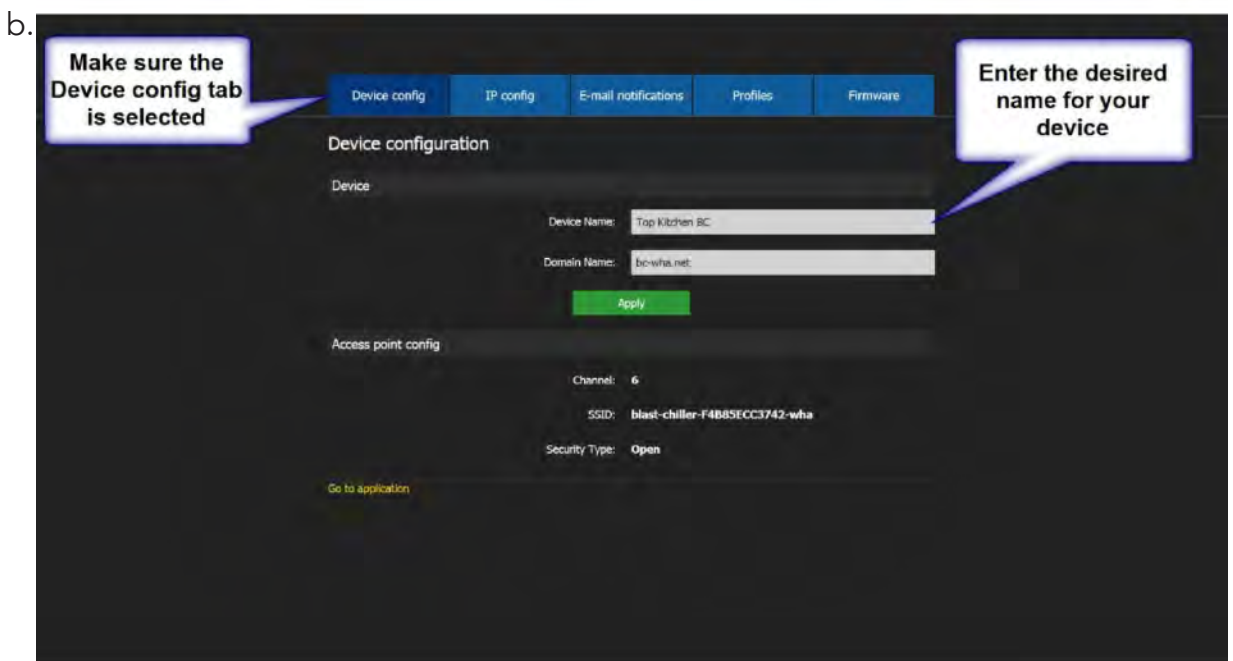
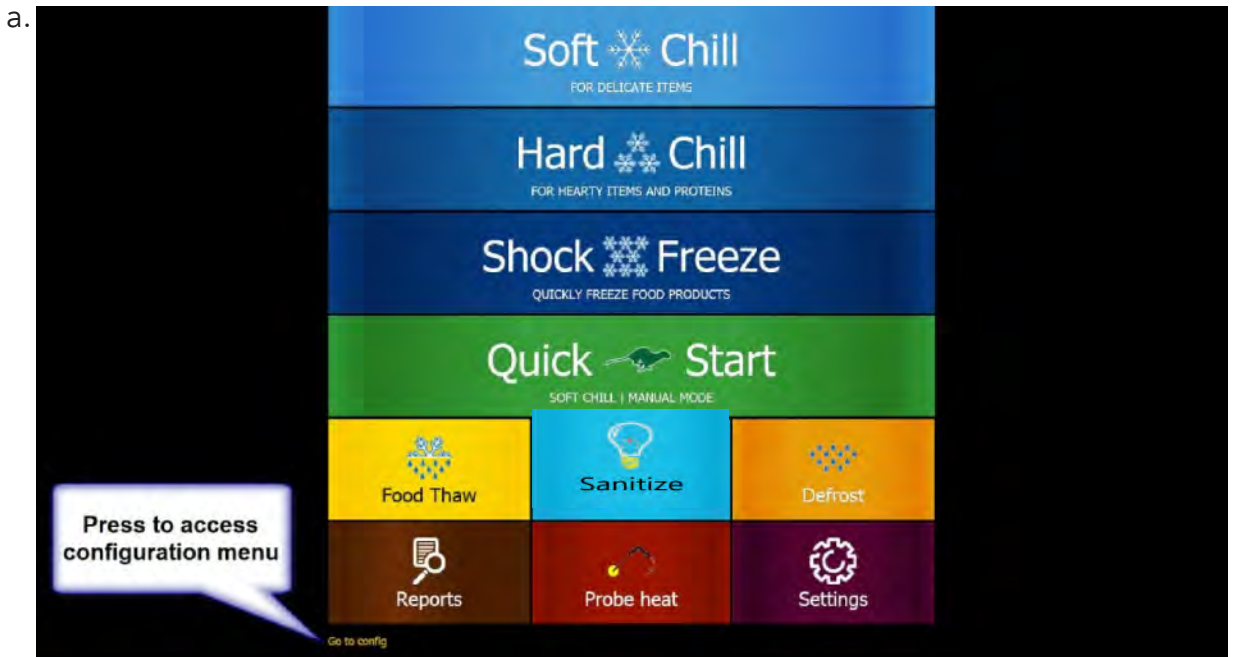

## Blast Chiller Controller Setup for Wi-Fi Network Connectivity (Cont'd)

c.

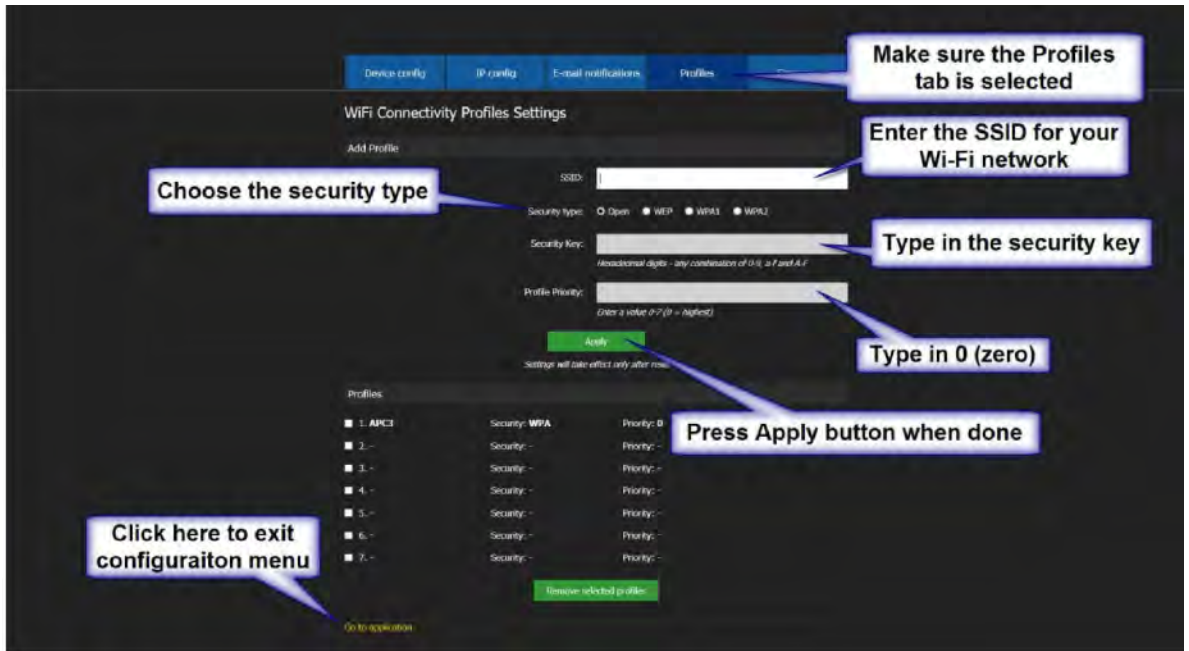

d. Reset power to the unit and allow few minutes for the controller to connect to the Wi-Fi network.

e. At the blast chiller controller, in the home screen push the settings button.

f.



g.

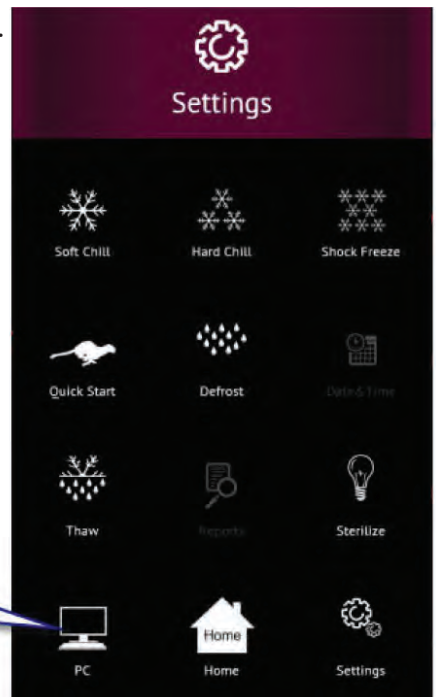

h.

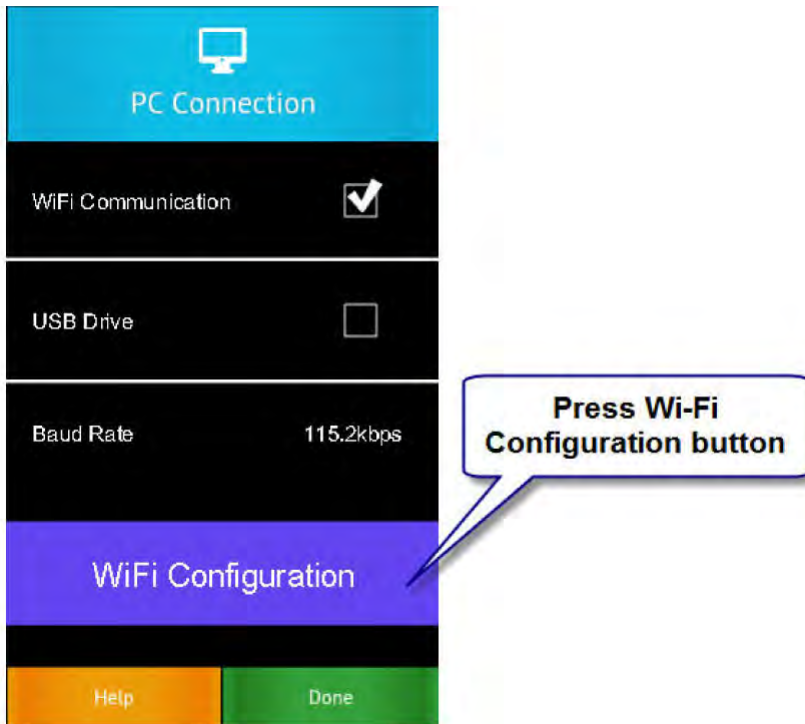

i.

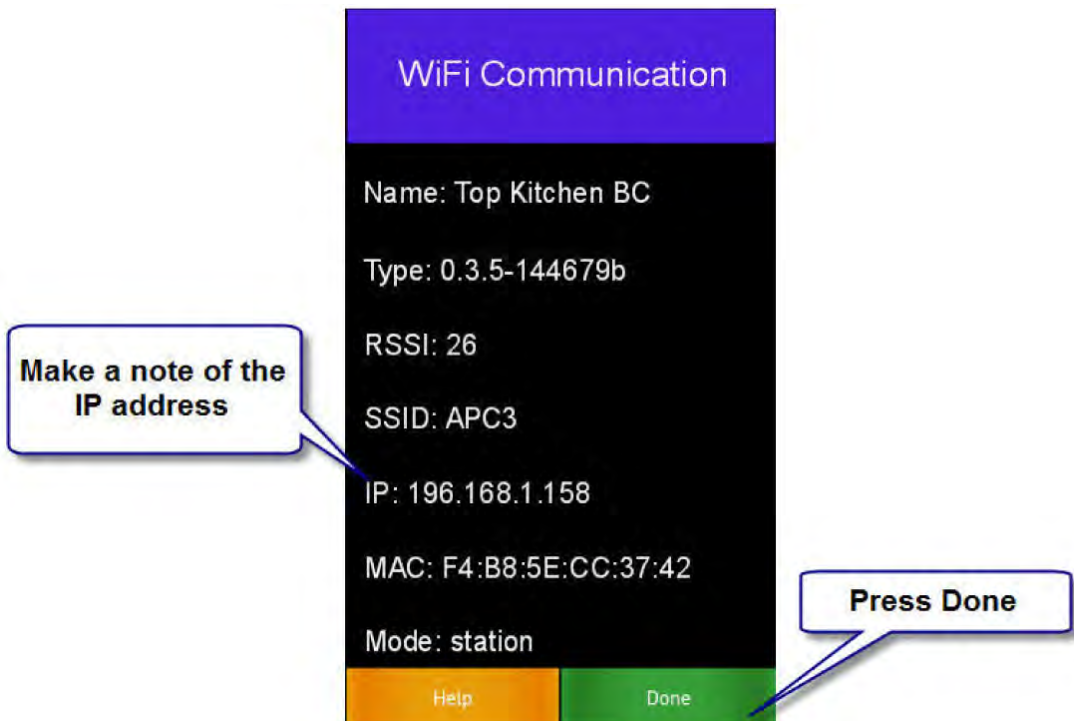

j. At your device, open your web browser and enter the noted IP address in the address bar.

k. The home screen should appear, save the address in the favorites for quick access.

## Unit Operation (Cont'd)

### Configure the controller to send e-mail alerts

1. Make sure that the blast chiller controller is connected to a Wi-Fi network with internet access; see "Blast Chiller Controller Set-up for Wi-Fi Network Connectivity".

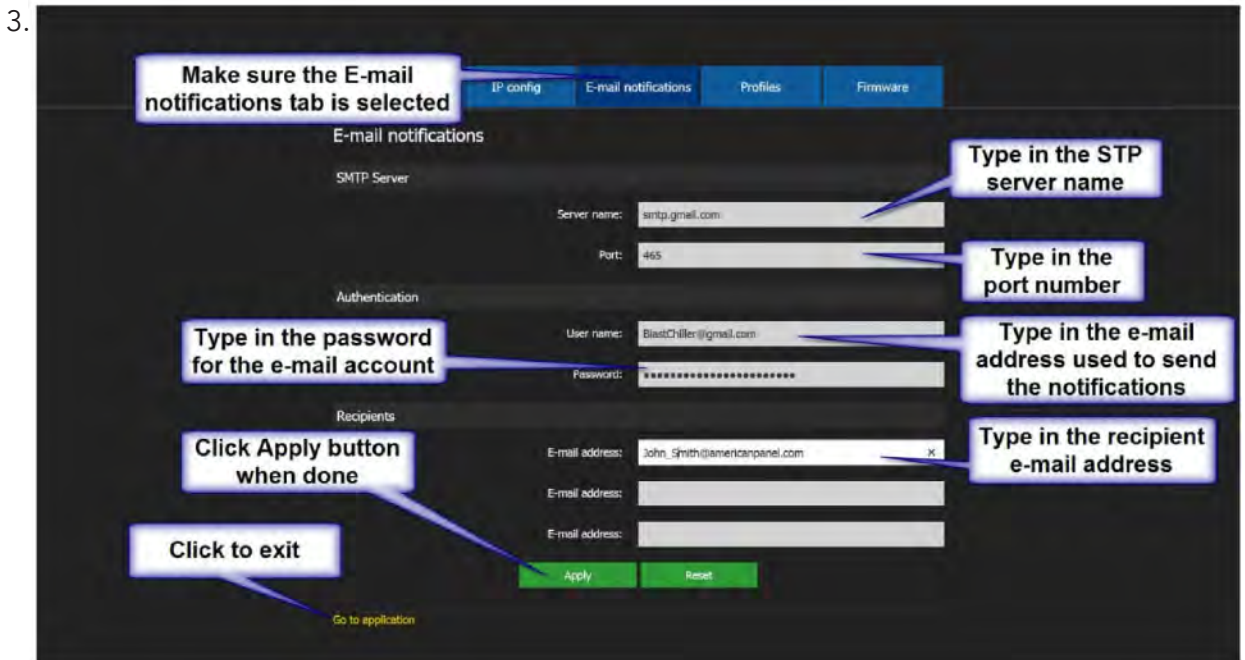

## Maintenance Instructions

---

### Daily Maintenance

---

- Defrost the unit daily or as needed (see instructions 3.6, 4.9 and 4.10).
- Wipe clean the interior and the exterior of the unit using a solution of mild soap and water.
- Wipe clean the door gasket.
- Engage the sanitization cycle (if so equipped).

#### **IMPORTANT!**

**Do not use any corrosive chemicals to clean the unit!**

**Do not use any abrasive materials to clean the unit!**

**Do not spray water on the unit!**

### Quarterly Maintenance

---

The quarterly maintenance should be done by a service technician or by trained maintenance personnel.

- Inspect door hinge for proper operation.
- Inspect door gasket for proper seal.
- Inspect the drain line for proper flow.
- Use vacuum and brush to clean the condenser coil.
- Clean the evaporator coil.
- Inspect the site glass to ensure it's clean and dry
- Use an 80/20 ice/water bath to check the accuracy of the probes.

#### **IMPORTANT!**

**Do not use water jet to clean the condenser coil!**

**Do not use any sharp or abrasive materials to clean the coils!**

### Recommended Cleaning Solution

---

When cleaning the evaporator use only the cleaning agent listed below and follow the directions on the container for proper mixing and cleaning.

Enviro-Coil Concentrate Home Depot Supply

<http://www.hdsupplysolutions.com>

Part No: H-ECO1

Enviro-Coil Concentrate Hydro-Balance Corporation

Tel: (972) 394-9422

## Blast Chiller Evaporator Coil Cleaning Procedure

---

The following cleaning procedure is recommended as part of routine maintenance activity for all American Panel Corporation blast chillers.

### IMPORTANT:

Do not use any sharp or abrasive tools to clean the evaporator coil!

Before cleaning the evaporator coil run the defrost cycle to make sure the coil is completely free of ice. When cleaning the evaporator coil particular attention must be paid to the kind of cleansing agent used. In particular the following products **MUST NEVER BE USED**:

- Ammonia or detergents which contain ammonia (ammoniac solutions)
- Bleach or products containing bleach (chlorinated liquids)
- Acid detergents such as anti-lime scale, various anti-incrustations, muriatic acid, sulfuric, hydrochloric and acetic acid liquids, etc. (highly acidic liquids)
- Acetone, trichloro-ethylene (organic solvents)
- Caustic soda and other highly alkaline substances (high basicity liquids)

All of the above substances can damage the protective coating and/or corrode the metal components and seriously damage the coil.

**WARNING:** Disconnect and lock the main power switch prior to cleaning the unit.

### Monthly

- Open the evaporator door by removing the screws that secure the door to the vertical frame and swing the door open.
- Use a vacuum cleaner or a soft non-metallic bristle to remove the surface loaded fibers and dirt. Apply the tool in the direction of the fins.
- Rinse the coil finned area and the return bends with plenty of clean look-warm water. To avoid damaging the fins and the coating, it is important that the water temperature is below 130oF and the water pressure is below 100 PSI.
- Close and secure the evaporator door.

### Quarterly

- Open the evaporator door by removing the screws that secure the door to the vertical frame and swing the door open.
- Use a vacuum cleaner or a soft non-metallic bristle brush to remove the surface loaded fibers and dirt. Apply the tool in the direction of the fins.
- Spray the coil finned area and the return bends with a generous amount of the recommended coil cleaner (see below) using a pump-up sprayer or conventional spray bottle. Refer to the manufacturer's directions on the container for proper mixing ratio.
- After cleaning the coil use the approved chloride remover (see below) to remove soluble salts and revitalize the unit. Use a pump-up sprayer or a conventional spray bottle to soak the finned area and the return bends. Refer to the manufacturer's directions on the container.
- Rinse the coil finned area and the return bends with plenty of clean look-warm water. To avoid damaging the fins and the coating, it is important that the water temperature is below 130oF and the water pressure is below 100 PSI.
- Close and secure the evaporator door.

*Recommended Coil Cleaner*  
**Enviro-Coil Concentrate**  
Hydro-Balance Corporation  
Phone: (972) 394-9422

*Recommended Chloride Remover*  
**CHLOR\*RID DTS**  
CHLOR\*RID International, Inc.  
Phone: (800) 422-3217

For parts for your  
specific HURRiCHiLL<sup>®</sup> unit,  
please send a request along with  
a copy of your  
data tag with serial and model # to:

**[parts@americanpanel.com](mailto:parts@americanpanel.com)**



**American Panel Corporation**  
5800 SE 78th Street  
Ocala, FL 34472

**P:** (800) 327-3015  
**F:** (352) 245-0726

APC\_HURRICILL-TS\_Manual 6/21