

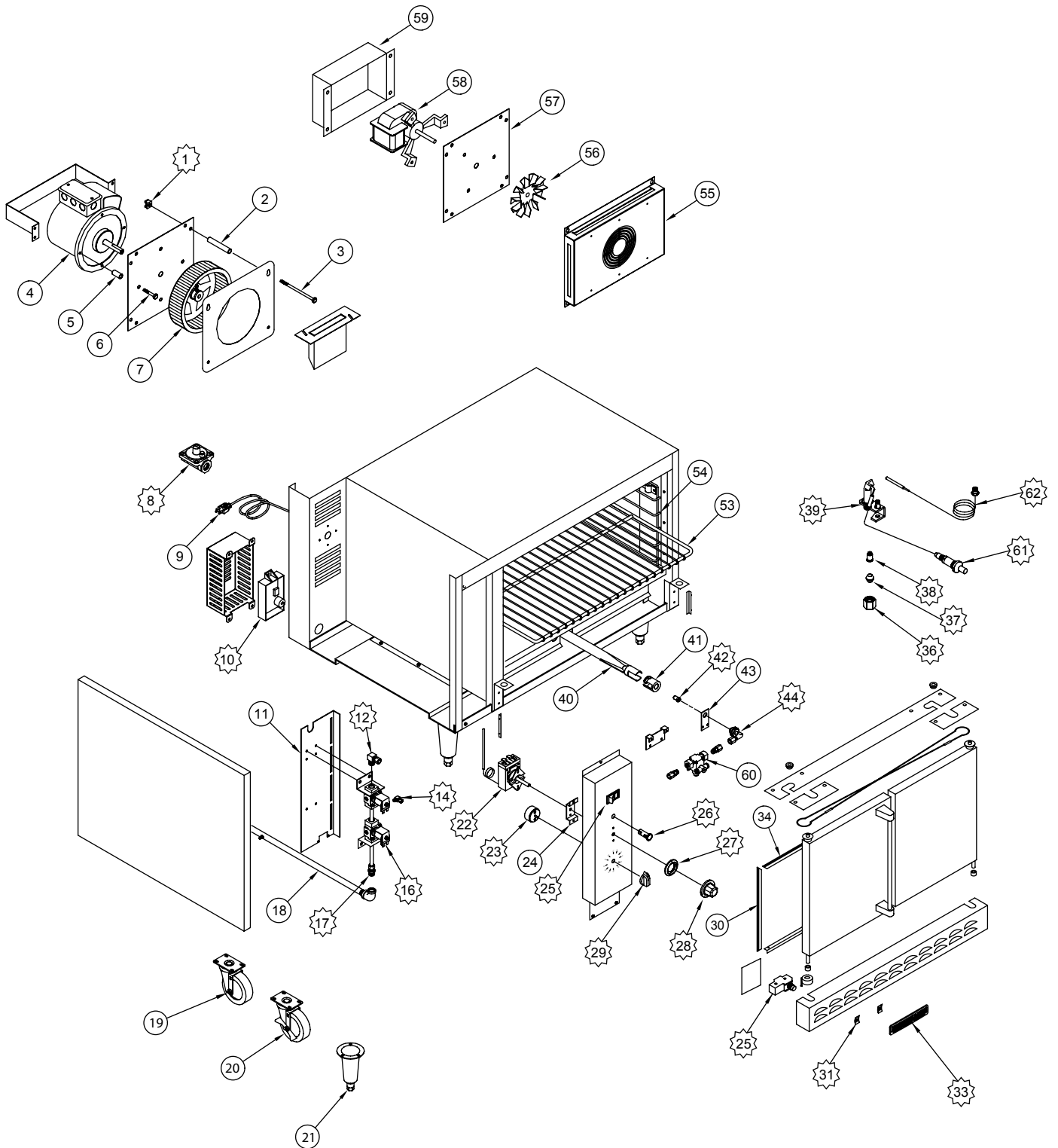









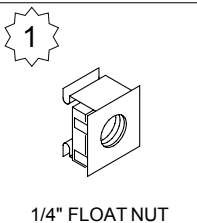

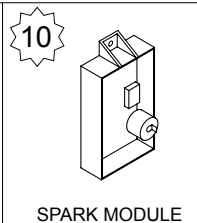
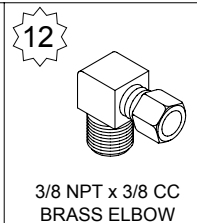

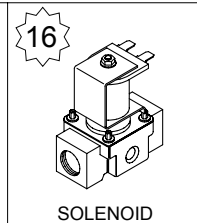
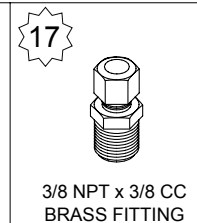
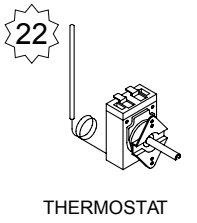
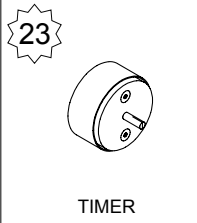
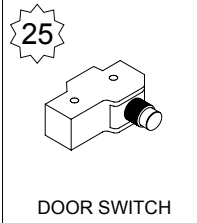
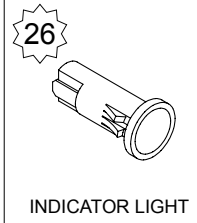

ARTL

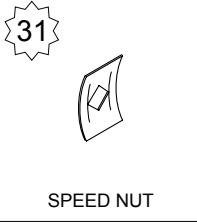

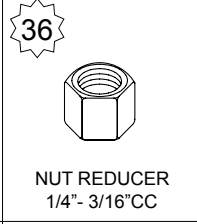
ARTL

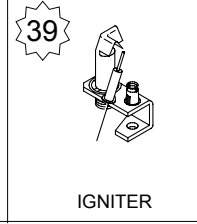
ITEM NO.	PART NO.	DESCRIPTION
1	A44001	Nut, Cage 1/4-20 Black
2	A43023	Sleeve, 3/8" X 3/16" Stainless
3	A42022	Bolt, Hex 1/4" X 5" GRD 5 ZP
4	A91004	Motor, ARC 115V 1/5HP 56YZ FLG
5	A43026	Spacer Short
6	A42004	Bolt, Hex GR5 1/4-20 X 1-3/8
7	A91200	Blower, Motor Wheel ARC
8	A80110	Valve, Pressure Regulator 3/4" Nat Gas Set 5.0
	A80011	Valve, Pressure Regulator 3/4" LPG Gas Set 10.0
9	A13100	Cord, Power NEMA 5-15P SJT 16/3"
10	A10062	Control, Gas Pilot Ignition Pilot Spark 120V MSD/Majestic/SAG
11	A99711	Mounting Panel for Components 1328
12	A28014	Elbow, 3/8" Compression Brass 10019
13	A10052	Spark Cable, Teflon w/1/4" QC Insulated Term. Short
14	A29303	Elbow, 3/16" CC - 1/8" Compc Brass 10000
15	A10053	Cable, Flame Sense 3/16" QC Fully Insulated Term. MSD/ARC Short
16	A80101	Solenoid, Valve Safety Gas 115V 10415-73462 HD/AR6C/M1/MSD/SAG
17	A28032	Fitting, 3/8" C X 3/8" MIP Brass

subject to change without notice.

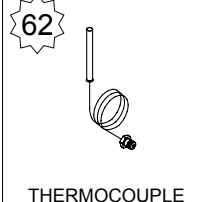
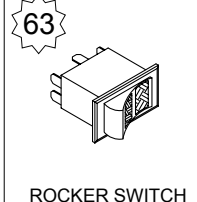
 <p>1 1/4" FLOAT NUT</p>	 <p>8 REGULATOR</p>	 <p>10 SPARK MODULE</p>	 <p>12 3/8 NPT x 3/8 CC BRASS ELBOW</p>	 <p>14 ELBOW 3/16"CC - 1/8"COMPC</p>	 <p>16 SOLENOID</p>	 <p>17 3/8 NPT x 3/8 CC BRASS FITTING</p>
 <p>22 THERMOSTAT</p>	 <p>23 TIMER</p>	 <p>25 DOOR SWITCH</p>	 <p>26 INDICATOR LIGHT</p>	 <p>27 BEZEL</p>	 <p>28 THERMOSTAT DIAL</p>	 <p>29 TIMER KNOB</p>
 <p>31 SPEED NUT</p>	 <p>33 AMERICAN RANGE NAME PLATE</p>	 <p>36 NUT REDUCER 1/4"- 3/16"CC</p>	 <p>37 SLEEVE, BALL 3/16" FERRULE</p>	 <p>38 ORIFICE BELL</p>	 <p>39 IGNITER</p>	 <p>42 ORIFICE HOOD</p>
 <p>44 ORIFICE ELBOW</p>	 <p>61 PIEZO IGNITOR</p>	 <p>62 THERMOCOUPLE</p>	 <p>63 ROCKER SWITCH</p>			

ARTL

ITEM NO.	PART NO.	DESCRIPTION
18	A15037	Manifold Pipe (Convection) AR 10101
19	A35014	Caster, 4" Swivel Plate Mount No Brake NSF AR,AGBU,ACB
20	A35015	Caster, 4" Swivel Plate Mount W/Brake NSF AR,AGBU,ACB
21	A35001	Leg, 6" Cone 3"Adjustable Bullet
22	A11105	Thermostat, KXT Electric M/MSD 10404 ARC/SAG
23	A60001	Timer, Cooking 60 Minute 10408 M/MSD/ARC
24	A99712	Bracket, KXT Thermostat M/MSD 1330 ARC
25	A10009	Switch, Rocker 3 Position 10406 M/MSD Series, ARC
	A10002	Switch, Rocker ON/OFF Innovection Oven
26	A10011	Light, Indicator 120 V Red 12.7 10407 W/Wire Lead & Male Term
27	A32023	Bezel, KXT-397-36 Thermostat 10440-C M/MSD/ARC
28	A32005	Knob, Dial KXT Thermostat 10411 M/MSD Series, ARC/SAG
29	A32017	Timer, Knob M/MSD Series 10409
30	A99708	Gasket Door Sides 1323
31	A44003	Nut, Speed #6 Push Black 10601
33	A38000	Name Plate, American Range 8" 10499 Quality Commercial Chrome
34	A99707	Door Gasket (Top & Bottom) 1322
36	A28020	Nut, Reducer 1/4" - 3/16" CC
37	A28021	Sleeve, Ball 3/16" Tube Barrel Oversize
38	A11118	Orifice, Bell .018 AR/AF NAT Gas 11001
	A11110	Orifice, Bell .010 LPG Gas 11002
39	A11104	Pilot, NAT Gas .018 5SL-2 AR/SAG 10413
	A11132	Pilot, LP Gas, .010 AR/SAG 10413L
40	R14020	Burner, Bake Oven ARROB/ARRSB/AR Ranges
41	A14049	Air Shutter, 1"
42	A29000	Orifice Hood, #39 1/2" Brass 11039 Nat Gas (Convection & Innovection)
	A29001	Orifice Hood, #52 1/2" Brass 11052 LPG Gas (Convection LP)
	A29007	Orifice Hood, #53, 1/2" Brass (Innovection LP)
43	A99713	Bracket, Orifice Bracket ARC 1341
44	A24000	Elbow, Orifice, Mixer 3/8" C-3/8-27 10442
45	A99517	Bracket Switch for Door ARC 10122
	A99518	Bracket, Door Switch for 60" UNIT 10123
46	A10024	Switch, AR6C Oven Door Snap Action Roller/Lever Style
53	A31006	Rack, Oven AR-C 10501 25-3/4" X 21-1/2" (Convection)
	A31025	Rack, Oven AR6 26-3/8" X 20-7/8" (Innovection)
54	A31008	Rack Guide, ARC Right 1320R (Convection)
	A31007	Rack Guide, ARC Left 1320L (Convection)
55	A91202	Blower Baffle (Innovection)
56	A91206	Fan, Blade Innovection Motor (Innovection)
58	A91100	Motor, Innovection Fan Assembly ARR-RANGE Series (Innovection)
60	A80100	Valve, Safety TS-11J AR Ranges 10425
61	A10010	Igniter, Piezo & Locking Nut
62	A11100	Thermocouple, 18" 2C AR Range
63	A10009	Switch, Rocker 3 Position 10406 M/MSD Series, ARC

subject to change without notice.