

Installation Instructions

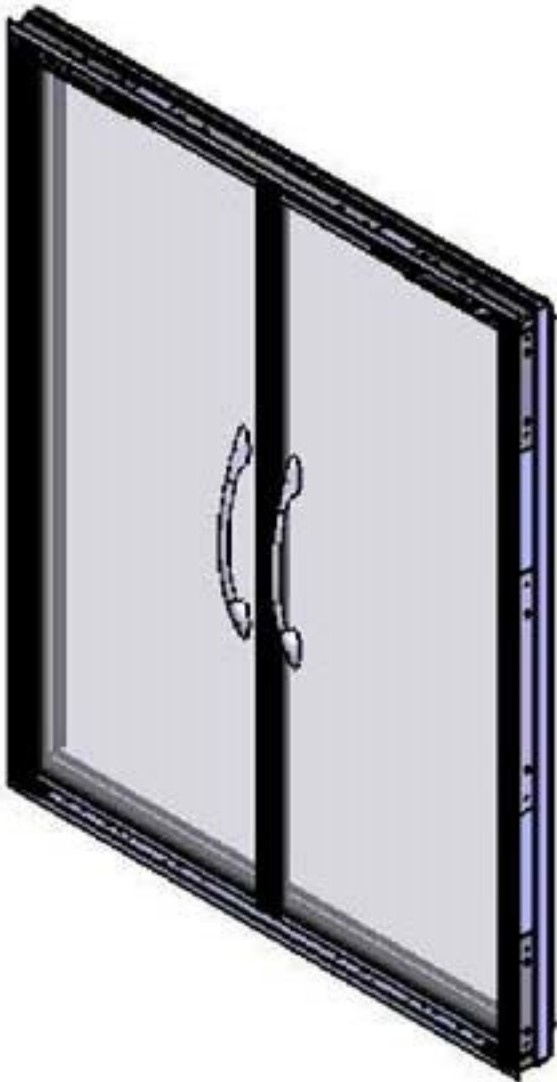

VSDR/VSER Door

99-22063-1001
Rev. B - 2022

Design with Anthony



Anthony Locations

North America Locations

Sylmar, CA

Corporate Offices

12391 Montero Avenue

Sylmar, CA 91342

Phone : (818) 365-9451

Toll Free From :

United States : (800) 772-0900

Canada : (800) 336-8825

Fax : (818) 365-2441

300

Madison, GA

1101 Sovis Rd

Madison, GA 30650

Phone: (706) 342-9300

Fax: (706) 342-9303

Safety and Warnings

FOR YOUR SAFETY

Read and observe all **CAUTIONS** and **WARNINGS** shown throughout these instructions. While performing installations described; gloves, safety glasses or goggles should be worn.



Prepare Electrical Wiring

Risk of fire or electric shock. Install this kit only in luminaires that have the construction features shown in the photographs and/or drawings. Luminaires, wiring, or other electrical parts may be damaged when drilling for installation hardware. Check for enclosed wiring and components.

Only those open holes indicated in the photographs and/or drawings may be made or altered as a result of kit installation. Do not leave any other open holes in an enclosure of wiring or electrical components.

To prevent wiring damage or abrasion, do not expose wiring to edges of sheet metal or other sharp objects.

Remove and dispose of existing ballasts per any local or Federal guidelines.



BEFORE YOU BEGIN

INSTALLATION OF THIS ASSEMBLY REQUIRES A PERSON FAMILIAR WITH THE CONSTRUCTION AND OPERATION OF ELECTRICAL SYSTEMS AND THE HAZARDS INVOLVED. Read instructions completely and carefully.



WARNING:

TO REDUCE THE RISK OF FIRE, ELECTRICAL SHOCK OR INJURY, OBSERVE THE FOLLOWING:

1. Use this unit in the manner intended by the manufacturer.
2. Turn power off before removing existing lighting system and follow appropriate lock out/tag out safety procedures



For use inside a commercial refrigeration case with packaged foods only.

VSDR/VSER Door Installation Instructions

Preliminary Considerations for Door & Frame Servicing	5
Tools Required	5
Tips.....	5
Frame Installation, Service & Maintenance	6
Shimming.....	8
Joining Multiple Frames	9
Frame Installation	9
Frame Electrical Wiring Connections	11
Door Installation - VSDR	14
Door Installation - VSER.....	15
Door Assembly Installation.....	16
TorqueMaster™ and SAG Adjustment.....	17
Door Assembly Removal.....	17
Replacing the VSER Door Model Handle Side Flap	19
Removing and Replacing the Vista D Door Rail Plastic Cover	21
APPENDIX A – Preventative Maintenance Guidelines.....	23
Introduction	23
Routine Preventative Maintenance	23
Periodical Inspection Recommendations	23
Recommendations	24
Cleaning Routine	25
Troubleshooting.....	26
Revision History.....	28

VSDR/VSER Door Installation Instructions

The installation of a VSDR or VSER requires installation of a new frame and door.

Preliminary Considerations for Door & Frame Servicing

Tools Required

#2 Phillips-head screwdriver	Flat-head screwdriver
Needle-nose pliers	Rubber or plastic mallet
7/16" & 1/2" hand wrench	5/32" hex key
Wire stripper and cutter	Soldering iron
Heat gun	Razor knife

Tips

- Complete replacement of wire assemblies is recommended whenever required. Splice wires only if necessary, using proper materials such as electrical tape, wire nuts, flux core solder and heat shrink.
- Apply liquid soap to rail plastic covers and gaskets upon installation, to facilitate insertion into mounting grooves.
- Keep doors and frames clean for product efficiency. This can also help reduce energy consumption and potential health hazards.
- Whenever binding gasket or plastic parts, use food grade silicone.
- Always use the correct tool for the job to be performed. This ensures proper installation and minimizes safety risks.
- If there is any doubt about the work to be performed, consult with a certified technician or Anthony representative.
- Preventive maintenance is recommended to ensure product longevity.

Frame Installation, Service & Maintenance

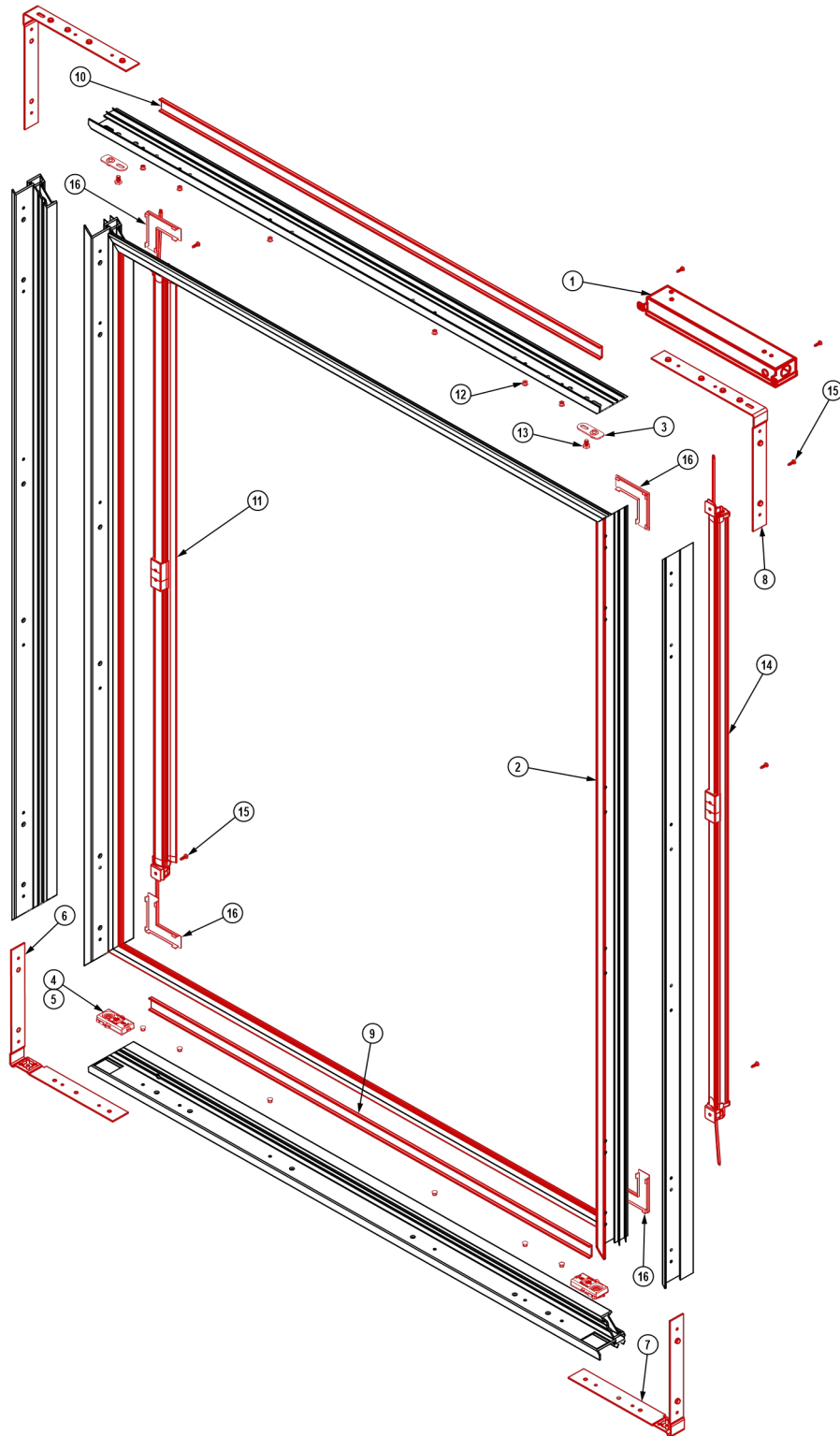

VSDR/VSER Frame

VSDR/VSER Frame Replaceable Parts

Item #	Part #	Description
1	02-20732-0000	RPF Remote Driver Enclosure Assembly
2	02-21331-0000	Aircell II Gasket & Magnet Assembly
3	02-20551-0001	RPF Top Slide Plate Assembly
4	02-11484-0002	Torque Master Assembly
5	40-10998-1003	PFH w/U-Cut Screw, 10-32 x 1/4
6	15-20297-1001	NT Shallow Frame Corner Bracket (Left)
7	15-20297-1002	NT Shallow Frame Corner Bracket (Right)
8	15-20549-1001	RPF Top Corner Bracket
9	20-20095-XXXX	Header/Sill Frame Rear Cap
10	20-20095-XXXX	Top/Ends Frame Rear Cap
11	60-20844-1001	54" 24V Left End LED
12	40-11124-1004	Steel Rivet, 3/16 x 5/16 x 3/8
13	40-20786-1006	RPF Hex Bolt, 7/16
14	60-20844-0001	54" 24V Right End LED
15	40-11114-3007	PPH Type B Screw, 8 x 1/2
16	20-21054-0001	RPF Corner Cover

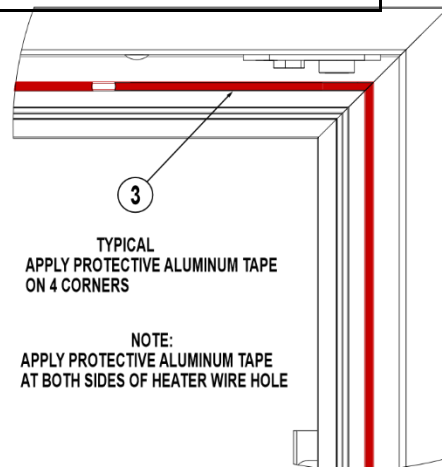
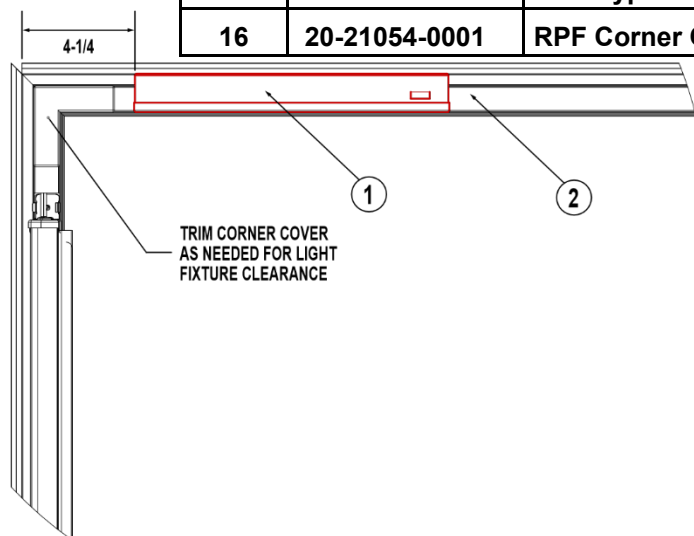

VSDR/VSER Driver & Heater Wire

VSDR/VSER Driver & Heater Wire Replacement Parts

Item #	Part #	Description
1	02-20732-0000	RPF Remote Driver Enclosure Assembly
2	40-11114-3007	PPH Type B Screw, 8 x 1/2
3	50-10632-00XX	Heater Wire
4	70-16185-0002	Aluminum Foil Duct Tape, 1/2"

1. Read instructions completely before installing the frame.
 - Clearance between the frame sill and the case bottom or floor is mandated by local building codes.
 - Sill net opening must be at minimum of two inches in height.
 - Sill must be completely level.
2. Before installing the frame, confirm that the size of the net opening accommodates the finish frame. If the tolerances are too high, the net opening will have to be enlarged.
3. Check the size of the finished frame to the net opening.
 - Subtract the frame height measurement, from the net opening's height measurement.
 - Subtract the frame width measurement, from the net opening's width measurement.
 - Divide each number in half. This is the amount of gap that will occur between the frame and the net opening.
4. If the gap between the frame and the net opening is greater than 1/16", shim the gap for a proper fit.

Shimming

1. Acquire sturdy, penetrable material, such as plywood. The thickness of the material should be wedge shaped or slightly less than the gap to be filled.
2. Measure the gap length (height or width of frame) and cut the shim material to 1/16" less than the measured length.
3. Install the shim using the same type of mounting hardware that will be used to install the frame. Be certain that the shim installation hardware will not interfere with the frame installation hardware.
4. If necessary, cut a second shim to the same length and install it in the opposite side of the net opening.
5. If the adjacent sides of the net opening need shimming, repeat the previous steps. Match the shim length to the frame sides of the net opening (less 1/16").

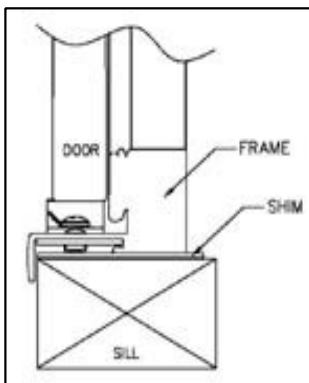

Anthony Door & Frame Cross-Section

Joining Multiple Frames

1. Align both frames parallel to each other on the floor. Be sure the installation holes from the end jambs are properly aligned. Use a 7/32" [.219"] drill bit to further increase the openings of all the installation holes.

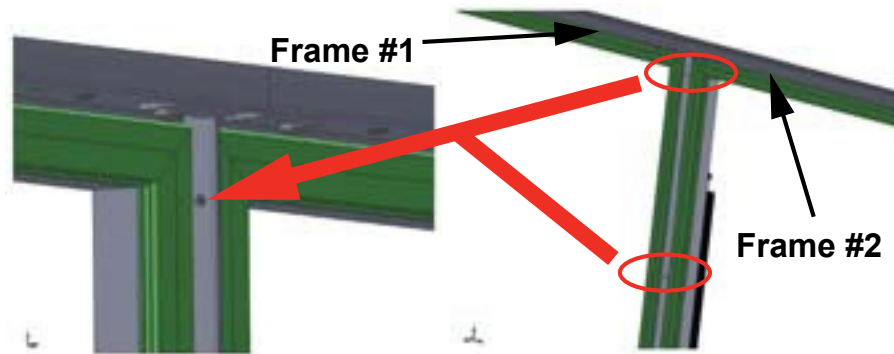

2. Insert binding posts (40-11131-3004) & screws (40-11065-3028) through installation holes as shown below & tighten securely.

NOTE: Use flat head screwdriver for this application.

Frame Installation

1. Verify openings conform to net openings listed in price book or original order.
2. Insert the finished frame assembly into the net opening. DO NOT force the frame if the fit is too tight.
3. Insert a mounting screw into a mounting hole in each corner of the frame and tighten each screw until it is approximately a quarter inch from flush.
4. Check the frame is aligned properly or square. Refer to "Frame Installation Reference".
 - Use a measuring tape to measure diagonally one corner to the opposite and note the distance.
 - Measure the distance between the remaining two corners.
 - Both measurements should be the same, within a 1/16" difference.
5. Confirm the frame and frame flanges are vertically aligned to the wall surface around the net opening.
6. Place a level on the top flange of the header frame to check if it is horizontally aligned.
7. If the top of the header frame sags or bows, correct as necessary.
8. When the frame is aligned, tighten all mounting screws securely until each is flush to the frame surface.

NOTE: DO NOT over-tighten the screws, as this can cause the frame to become out of square.

9. Check entire frame to ensure installation is correct.

NOTE: Use caulk and food grade silicone sealant to seal the gap between the frame and the surrounding wall, inside case, cooler or freezer.

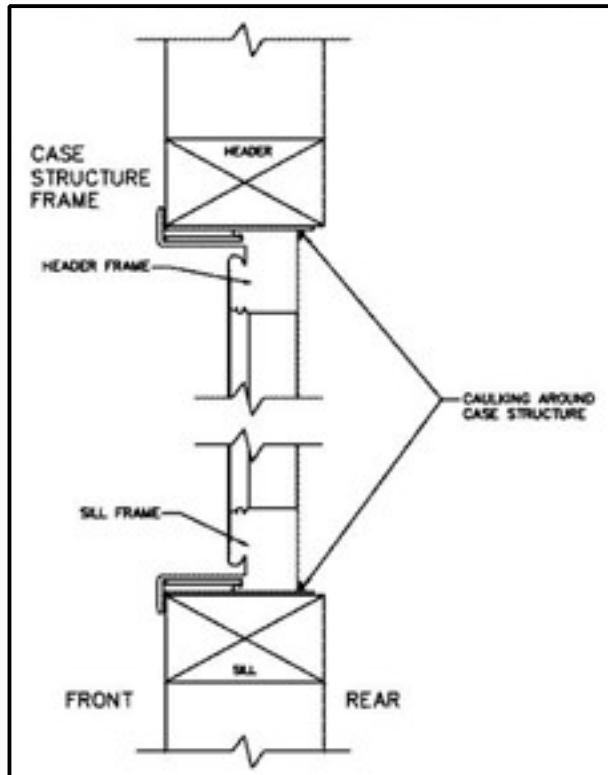

CAULKING - REAR VIEW
SEAL FRAME TO WALL MOUNT FROM REAR

PLUMB
VERTICALLY
CORRECT MOUNT

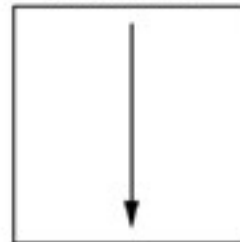

SQUARE
MEASURE DIAGONALLY
FROM CORNER TO CORNER

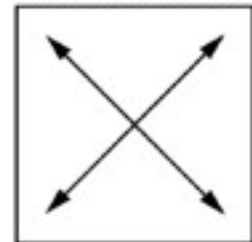

Frame Installation Reference

Frame Electrical Wiring Connections

1. Before connecting any wires to the remote power supply, ensure all electrical power circuits are turned off. Connect black (+), white (-) and green wires from the remote power supply to the line voltage (120-277 VAC) using NEC wiring and connectors. Secure the Remote Driver Enclosure with mounting screws per National Electrical Code (NEC).

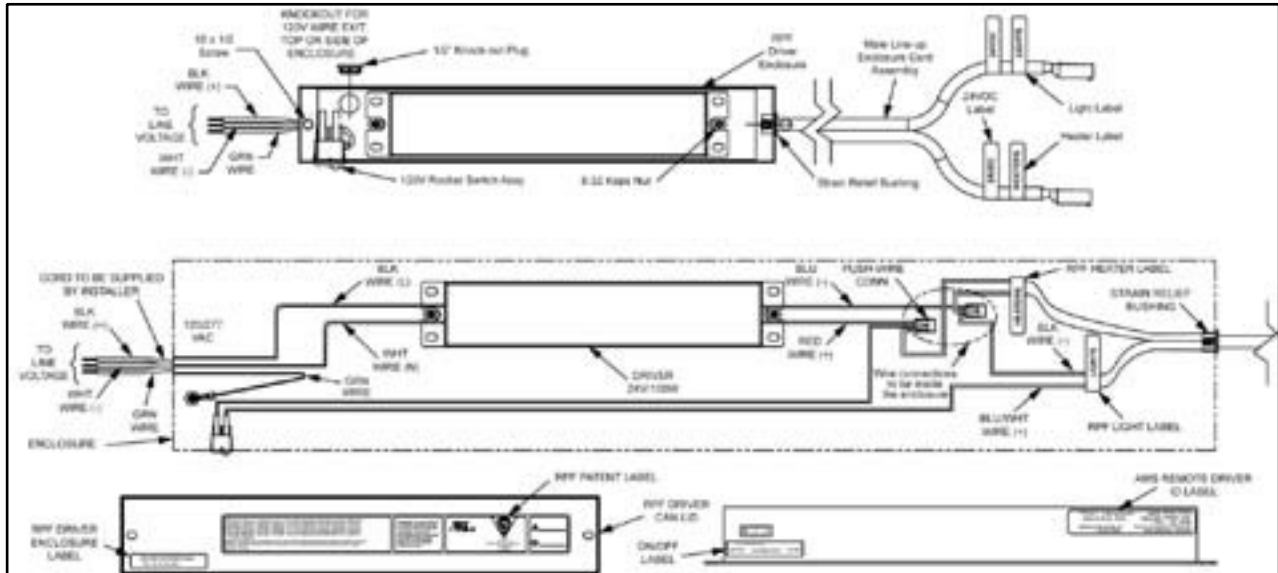

RPF Remote Driver Enclosure Assembly – One Frame Setup Heater/Lights

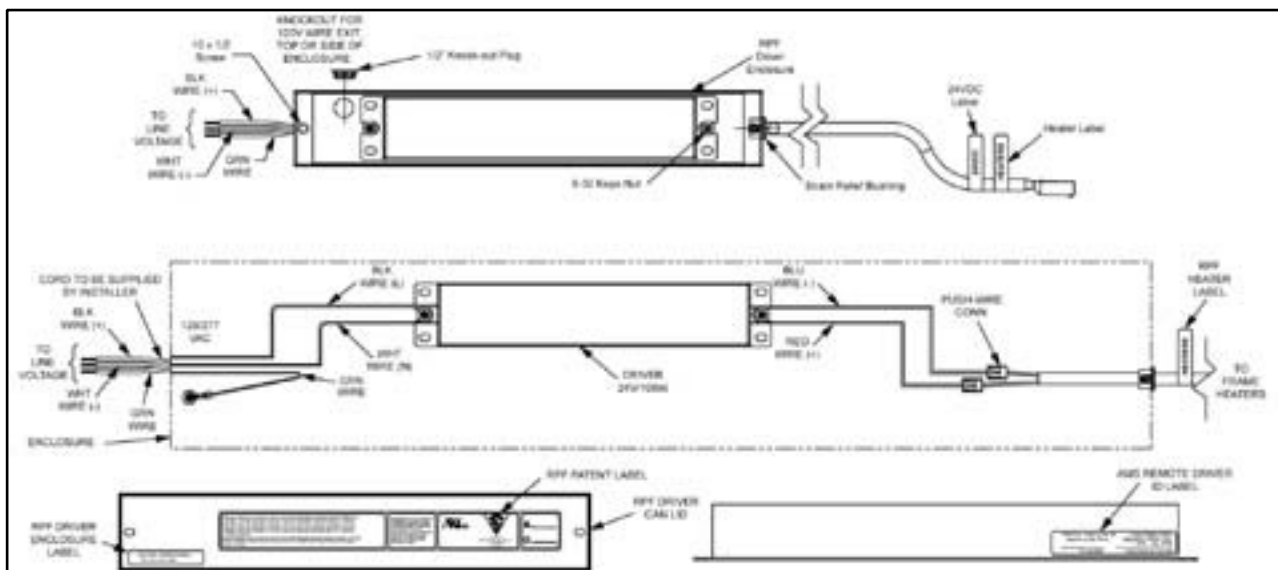

RPF Remote Driver Enclosure Assembly – One/Two/Three Frame Setup Heaters Only

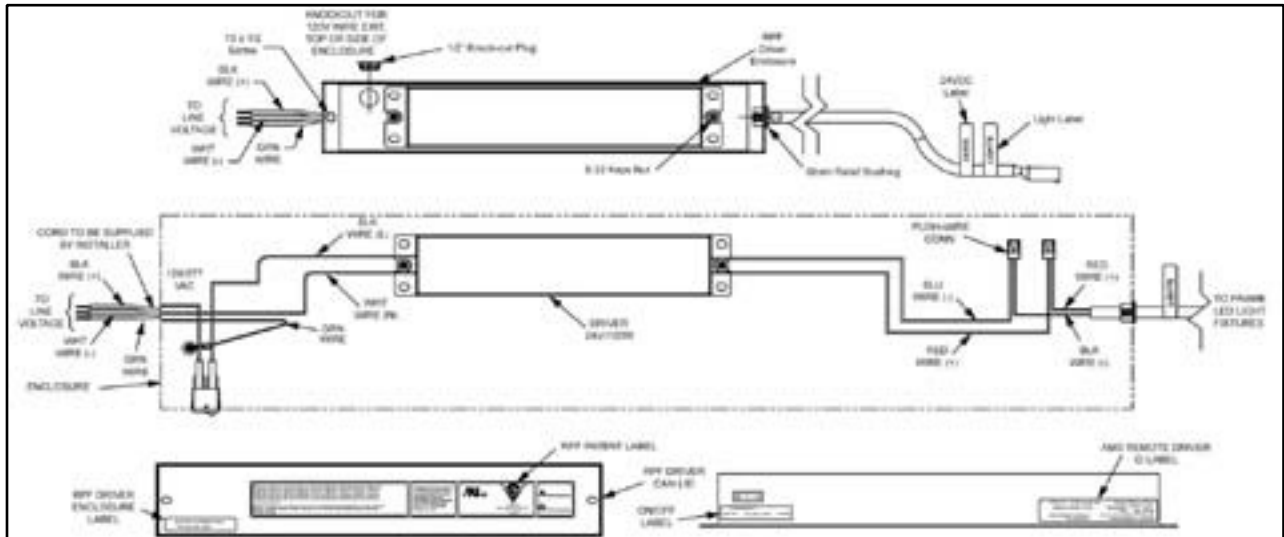

RPF Remote Driver Enclosure Assembly – Two/Three Frame Lights

2. Once the frames are installed, connect output “LIGHTS” wire from the remote power supply to the frame input wires labeled “LIGHTS”. Repeat for “HEATERS” to “HEATERS”.

If more than one frame is in a series, connect the daisy-chain wire connectors between the frames; “LIGHTS” to “LIGHTS” and “HEATERS” to “HEATERS”. Each Remote Driver is 100 Watts maximum. Add up all frame and light wattage taken from the frame name plates. This value is not to exceed 100 Watts.

NOTE: All frame wiring must be routed and secured to protect it from damage or being pulled loose.

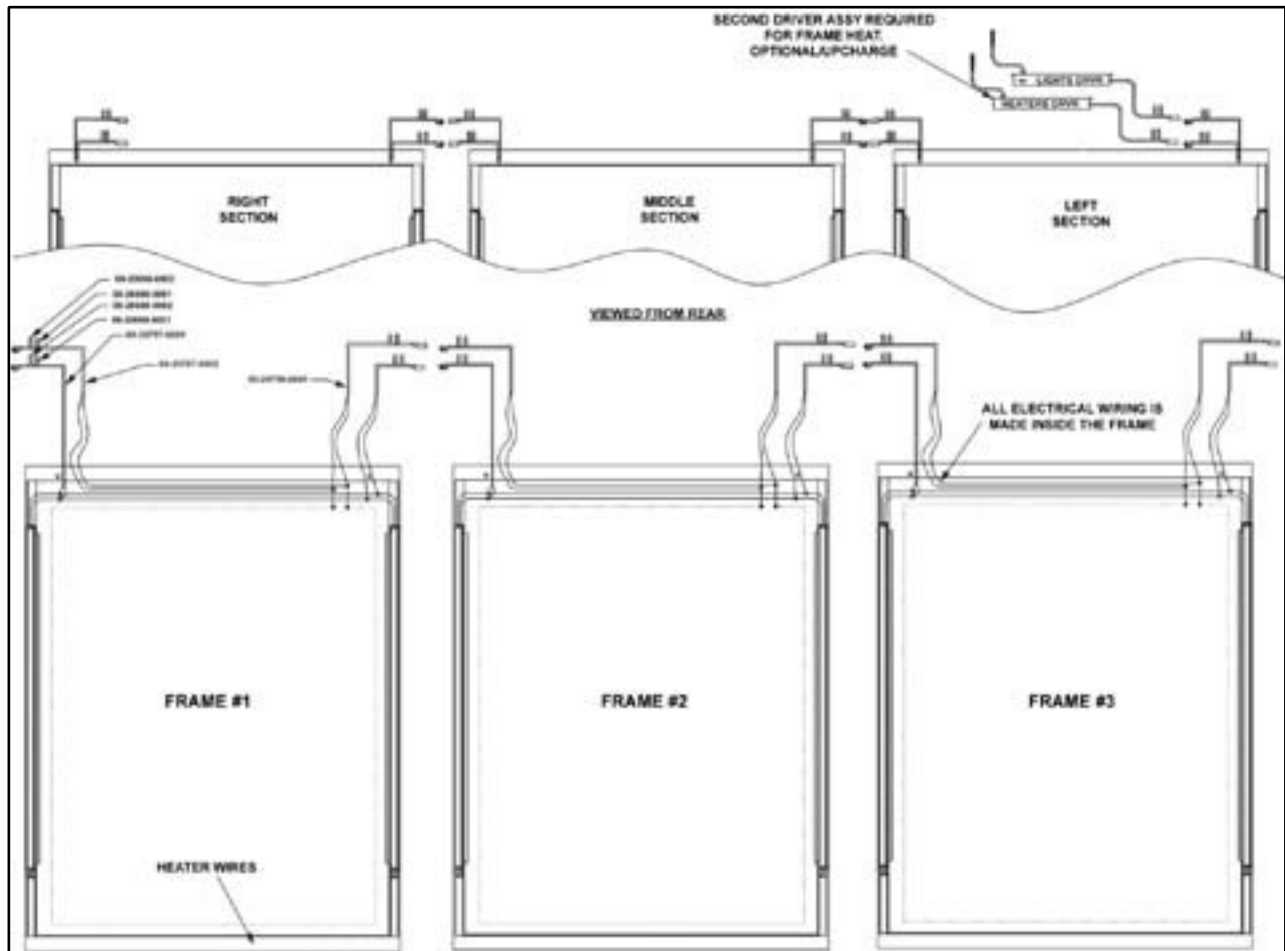

RPF Remote Driver Enclosure Assembly – 3-Frame with Lights and Heat

Door Installation - VSDR

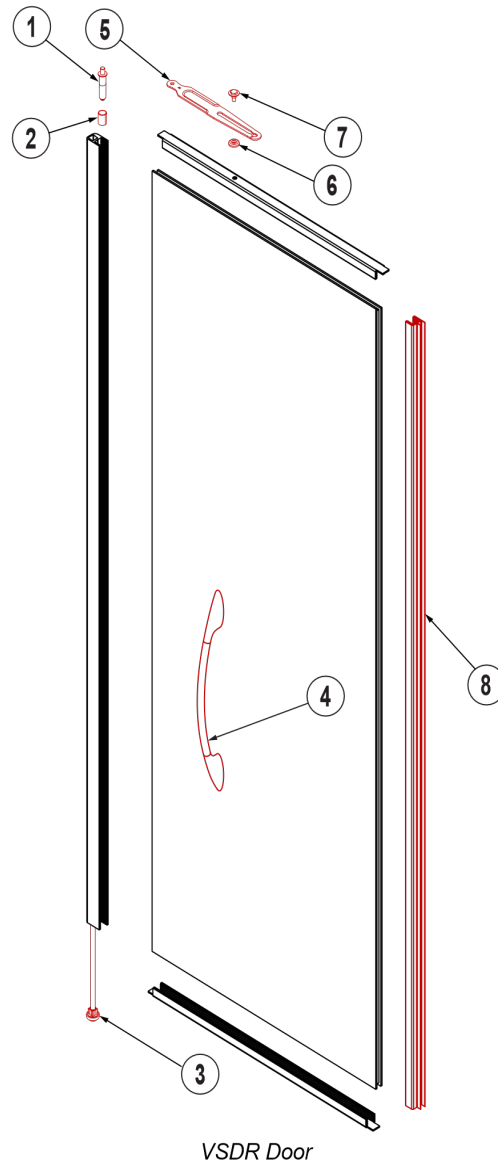

VSDR Door Replaceable Parts

Item #	Part #	Description
1	02-20547-0001	RPF Retractable Hinge Pin Assy
2	40-17280-0001	Vista Top Bushing
3	02-10308-000X	Torque Rod Assy
4	02-17272-0001	Vista Door Arch Handle Assy
5	15-14707-0001	Closed End Hold Open Fork
6	40-15097-0001	Hold Open Detent Spacer
7	40-15096-0001	Vista Hold Open Detent Bolt
8	20-21264-0000	VSDR Handle Door Rail w/Flap

Door Installation - VSER

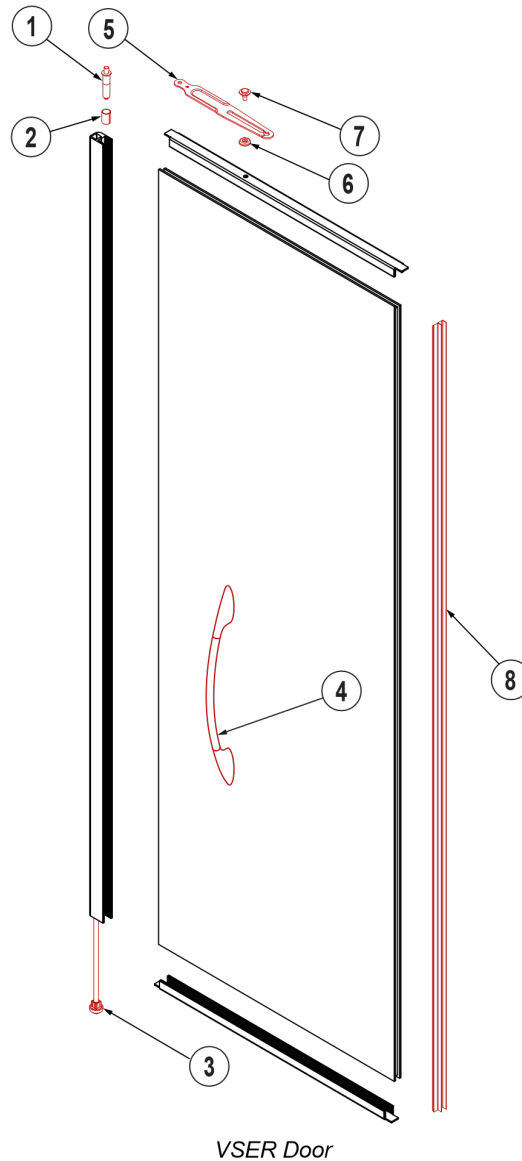

VSER Door Replaceable Parts

Item #	Part #	Description
1	02-20547-0001	RPF Retractable Hinge Pin Assy
2	40-17280-0001	Vista Top Bushing
3	02-10308-000X	Torque Rod Assy
4	02-17272-0001	Vista Door Arch Handle Assy
5	15-14707-0001	Closed End Hold Open Fork
6	40-15097-0001	Hold Open Detent Spacer
7	40-15096-0001	Vista Hold Open Detent Bolt
8	20-21051-0000	VSER Handle Door Rail w/Flap

Door Assembly Installation

1. Hold the door on each side, with the handle facing forward. Lift the door and align the torque rod to insert into the TorqueMaster™ socket at the base of the frame.

NOTE: Exercise caution when handling the door.



2. Engage the door with the retractable hinge pin inserted into the slide plate (retractable hinge pin) receptacle at the top of the frame. Push the door into the frame until the hinge pin snaps into place.
3. Insert the slide plate through the elongated slot in the frame.
4. Insert the mounting hex bolt into the frame mounting hole and tighten it, using a 7/16" open-end wrench.
5. Insert the hold open into the frame standoff and secure it in place with a mounting screw (provided)..



NOTE: DO NOT over tighten the hold-open bolt. Verify that the hold-open does not bind while sliding along the hold-open bolt. Adjust as necessary.

6. Set the door tension swing and correct the door alignment by adjusting the TorqueMaster. (See "TorqueMaster and SAG Adjustment". Refer to TorqueMaster Assembly figure.

TorqueMaster™ and SAG Adjustment

The TorqueMaster™ regulates the door alignment and the door closing tension.



1. Adjust the torque rod tension by using a flathead screwdriver to turn the outside screw on the TorqueMaster™.
 - Turn counter-clockwise to increase tension.
 - Turn clockwise to decrease the tension.
2. Adjust the door sag to square the door in the frame by turning the screw marked SAG ADJ. (sag adjustment) on the end of the TorqueMaster™ until the door is aligned square in the opening.
 - Turn counter-clockwise to raise handle side of door.
 - Turn clockwise to lower the handle side of door.

NOTE: DO NOT use power tools when adjusting the TorqueMaster™.

Door Assembly Removal

1. Release tension on the TorqueMaster with a flat-head screwdriver. Turn the TorqueMaster front facing screw clockwise, until the door does not automatically close from an open position.



2. Open the door to access the hold open device, then loosen and remove the holdopen detent bolt using a 7/16" hand wrench.



3. Retract the door to a near-closed position.
4. Lift the door out of the TorqueMaster and disengage the loaded spring from its receptacle at the top of the door. Secure or lean the door on its side against a stable surface.



Replacing the VSER Door Model Handle Side Flap

1. Remove the old flap and make sure that all the glass is clean on the surface and of any excess sealant



2. Apply silicone sealant on the new flap



3. Make sure that the silicone sealant is from end to end of the door rail.



4. Make sure that the silicone sealant bead is no bigger than a 3/8" in width.



3. Remove the tape from the door rail. Place the door rail on the edge of the glass. Make sure the sealant should be against the edge of the SGU and the side with tape on the back of the SGU.



Removing and Replacing the Vista D Door Rail Plastic Cover

1. Take hold of the plastic cover by hand and simply pull it away from the door. Continue pulling until the cover is fully removed.



2. To replace the plastic cover line the cover up with the edge of the door and press it in until it is snug against the door. Continue seating the cover along the length of the door.

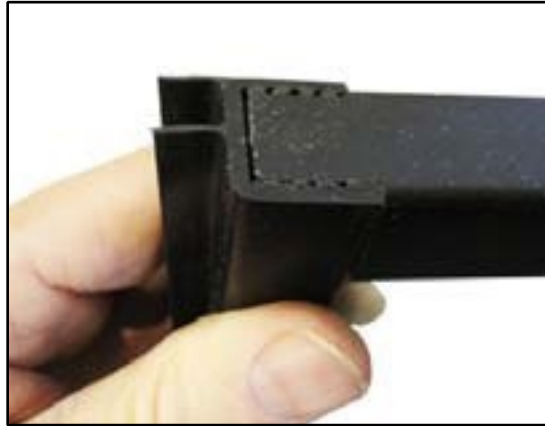

APPENDIX A – Preventative Maintenance Guidelines

Introduction

This guideline provides information required to perform recommended and required preventative maintenance to the Anthony doors and frame.

Routine Preventative Maintenance

The following provides information needed to safely perform regular periodical preventive maintenance. Regular preventative inspections will maximize the longevity of your Anthony products. These simple tasks will go a long way in ensuring optimal performance. Depending on maintenance being performed you may need to shut down the door or kill all power to the doors. Refer to your specific door model Installation Manual on how to disengage power. The use frequency of doors will vary from location to location, and the frequency in routine for preventative maintenance will vary for everyone depending on the amount of traffic.

For Anthony products used in harsh or extreme ambient conditions, it is recommended that these inspection intervals be performed on a more regular basis. When issues are found please refer to your specific model's installation and service manual for detailed information on how to replace and re-order needed parts or contact your Anthony representative.

Periodical Inspection Recommendations

Action	Store Conditions	Description
Preventative Inspection	Normal Conditions	Once each quarter (every 3 months)
	<u>Harsh Conditions</u>	Once a month (every 30 days)
Cleaning	All Conditions	Once a month (every 30 days)

Note: These are recommendations based on historical data of other Anthony door products and can vary depending on location, store conditions, store traffic, and other unknown variables.

Recommendations

Here is an outline of standard recommend Preventative Inspection criteria:

- **Freezer/Cooler Temp & Defrost Settings –**
 - Regularly inspect and ensure that ambient conditions are correct*
 - Ensure HVAC vents do not blow directly on doors
 - Avoid direct evaporator air impingement on the cooler/freezer door. This can be achieved by ensuring shelves are always fully stocked.
 - The cooler/Freezer must be regularly inspected for air leaks this can affect the temperature
 - Visually inspect box penetrations and adjoining surfaces: the use of a flashlight is helpful

**Refer to the values that pertain to your specific Door Model for Operating Condition values that are required for optimal door performance.*
- **Frame & Door –** Regularly ensure to check for wear/tear on frame and door this can include:
 - Ensuring that warning labels and product identification labels are all intact
 - Ensure all Bezels are intact and not damaged
 - Ensure that Vents are clean and allow maximum Airflow
 - Ensure all plastic backs are secured and undamaged
 - Handles are secured to the door
 - Ensure the door is opening to the angle of 87°
 - Rails are intact, not broken, and securely in place
- **Door/Frame Hinging Pin & Receptacle Area –** Regularly ensure to check for wear/tear all hinging parts include:
 - Inspect that the Hinge Pin is properly connected with the frame receptacle, **DO NOT** remove the factory installed dielectric grease from the Hinge Pin assembly to ensure the proper function
 - Inspect that the Hinge Pin and receptacle are rust/corrosion free, and there is an adequate amount of Dielectric Grease present
 - If when replacing or servicing Door and it is removed from the Hinge Pin receptacle, ensure to re-apply dielectric grease before installation of the door
 - Anthony recommends applying a minimum of three (3) grams per door Hinge Pin receptacle of its High-performance Dielectric Grease (Refer to the specific door model's installation manual for more detailed instructions on how to apply)
 - Anthony P/N: **98-25497-0001** (approximately 100 grams, sufficient for up to 30 door receptacles).
 - Anthony P/N: **98-25497-0002** (approximately 3 gram packet, sufficient for up to 1 door receptacle).
 - Replace any broken or damaged Hinge Pin and ensure to apply an adequate amount of Dielectric Grease
 - Visually and mechanically Inspect Hold-Open Arm, Screw, and Spacer for wear/tear/damage and that Screw is secure

- **TorqueMaster™** – To check the TorqueMaster™ is functioning correctly open each door and ensure that the tension makes the door close smoothly and gently on its own. If the door closes either too slowly or rapidly the issue can be fixed by adjusting that Torque Master™ refer to the “Torque Master™ and Sag Adjustment” section for details. If after adjusting the issue is still present the next step is to replace the Torque Master™, refer to the specific door model’s installation manual for detailed instructions on replacing.
- **Gaskets** – When inspecting gaskets ensure that they are sealing properly along the entire perimeter of the door. Also, ensure that the gasket is properly inserted into the door plastic groove. Inspect and ensure gaskets are free of cracks, tears, deformities, and hardening.

Cleaning Routine

List of Items that should be cleaned during monthly cleaning routine:

- **General Cleaning** – Regularly clean by wiping down the frame, door rails, bezels, and gaskets by checking for food debris, dust, and other foreign objects that may prevent the door from closing correctly. Use non-abrasive cleaning apparatus (i.e., microfiber cloth) when wiping down frame and door rails.
- **Cleaning Inside Door Glass***: To clean door glass on the inside of the door. We recommend the following cleaners:
 - Windex® Original
 - Windex® Vinegar
 - Fantastik®
 - Formula 409®
 - MicroClean Professional APC®

NOTICE	
	<p><i>Note – Any cleaner used or listed here MUST be Ammonia Free. Only use cleaners on glass portion of the door. Using harsh chemicals on PVC or ABS plastic portions of door may damage material.</i></p>

Troubleshooting

PROBLEM / ISSUE	PROBABLE CAUSES / FIXES	FINAL REMEDY
Condensation on Door Glass, Door Rail, or Frame	Fan to Door Proximity too small	Install air deflector
	Evaporator fans blowing cold air directly onto glass/frames	
	Shelves not fully stocked	Stock merchandise
	Door/gasket seal malfunction	See "Insulation or Air Leaks"
	Store conditions (temperature and relative humidity) outside required	Adjust HVAC / Dehumidifier settings to meet required
	Cooler/freezer temperature set too low	Adjust cooler/freezer temperature to design specified
Condensation in between Glass Panes	Seal compromised cause loss of gas or vacuum (check by cleaning the glass on merchandise and customer sides)	Replace door
Rust/Corrosion on Hinge Pin	Excessive moisture from ambient/store conditions	Add Dielectric Grease to Hinge Pin Receptacle Replace Hinge Pin/ add adequate amount of Dielectric Grease
Ice buildup inside Freezer	Air infiltration Box/frame not sealed according to Anthony instructions	See "Insulation or Air Leaks"
Door not closing or sealing	Check gasket to ensure proper installation	Replace gasket
	Check the gasket for damage	
	Check Hold-Open	Replace Hold-Open
	Check TorqueMaster torque (plumb)	Replace TorqueMaster2
	Check TorqueMaster sag	
	Check Frame/Door is square	
	Check Plastic covers on rails	Replace Plastic Covers
	Check Plastic covers on frame mullions	
No Power to Frame	Check Power Supply	Adjust energy controller to Full-On Replace Power Supply Replace Energy/Humidity Controller Replace Hinge Pin Replace wiring
	Check energy/humidity controller	
	Check hinge pin connections	
	Check glass wire connections	
	Check hinge pin wiring	
Low Voltage	Check main voltage	Adjust energy controller to Full-On Replace Frame heater wires
	Check humidity controller	
	Check the Amp draws to the heater wires in the frame	
Door/Gasket Seal - Malfunction	Check gasket	Replace gasket Replace hinge pin Replace TorqueMaster
	Check door mount	
	Check Door is square and level	
Frame not Square or Plumb	Frame not properly shimmed	Use correct Shim to level frame Use rubber mallet to adjust frame plumb within 1/16"
	The frame should be square to within 1/16"	
	The frame should be plumb within 1/16"	
Insulation or Air Leaks	Frame must be properly shimmed, level, and plumb	Seal gaps with approved NSF-approved Food Grade Silicone Sealant per Quick Installation Requirements Guide.
	Ensure encapsulated blue board insulation is present (Thermal Frame with Low Temp and NT High Humidity applications only)	
	Use RTV-108 NSF Approved Silicone Caulk to fill the perimeter of the frame on the refrigeration side (inside the case) and at all frame joints as required so there are no air gaps.	
	Use RTV-108 NSF Approved Silicone Caulk to fill the perimeter of the frame on the refrigeration side (outside the case) and at all frame joints as required so there are no air gaps.	
	Ensure Gap between frame and refrigeration does not exceed 1/8", gaps larger than 1/8" will require additional shimming to reduce gap size before sealing	
	Ensure all electrical conduits are properly sealed to prevent moisture and air from migrating into the box, use RTV-108 NSF Approved Silicone Caulking if necessary	

PROBLEM / ISSUE	PROBABLE CAUSES / FIXES	FINAL REMEDY
Glass condensation	No Power	Check power supply Check humidity controller Check Hinge Pin connections Check glass wire connections Check Hinge Pin wiring
	Low voltage	Check main voltage Check humidity controller
Door/Frame Rail Condensation	No Power	Check power supply Check humidity controller Check hinge pin connections Check door wire connections Check frame wire connections
	Low voltage	Check main voltage Check humidity controller hinge pin
	Door seal malfunction	Check gasket Check door mount wiring
Door saw-toothed	Door or frame not square	Square door to 1/16" Adjust TorqueMaster sag Replace worn hinge pin socket Facility or case not level Frame not properly shimmed Hold-open binding/damaged
Lamp inoperative	Power switch OFF	Turn power switch ON
	Lamp burned-out	Replace lamp
	Lamp failure	Check socket mounting Check socket/lamp connection Check ground wire connection
	Incorrect lamp	Replace with correct lamp
	Ballast failure	Check wire connections Replace ballast
	Incorrect ballast	Replace ballast
	Incorrect wiring	Check ground wire connection Reconfigure wiring Replace wiring
Lamp intermittent or dimming	Incorrect voltage	Match lamp voltage to circuit Match ballast to circuit voltage
	Lamp cover failure	Check cover installation Check mullion lens installation Replace lamp cover
	Defective wiring	Check & replace wiring
	Defective LED Fixture	Replace LED Fixture

Revision History

REV	ORIGINATOR	DESCRIPTION OF CHANGE	DATE
A	Pedro Almaguer	Initial Release	04/06/2015
B	E.CHAVEZ/K.HOLST	Added APPENDIX A. See ECN 18520	07/15/2022
C	K.HOLST	. See ECN 19366	09/1/2023