



SERVICE MANUAL



SINGLE RACK OVEN SHOWN

OV520E ELECTRIC RACK OVENS INSTALLATION INSTRUCTIONS

OV520E1
OV520E2

ML-132579
ML-132578

SINGLE RACK
DOUBLE RACK

- NOTICE -

This Manual is prepared for the use of trained Hobart Service Technicians and should not be used by those not properly qualified.

This manual is not intended to be all encompassing. If you have not attended a Hobart Service School for this product, you should read, in its entirety, the repair procedure you wish to perform to determine if you have the necessary tools, instruments and skills required to perform the procedure. Procedures for which you do not have the necessary tools, instruments and skills should be performed by a trained Hobart Service Technician.

The reproduction, transfer, sale or other use of this manual, without the express written consent of Hobart, is prohibited.

This manual has been provided to you by ITW Food Equipment Group LLC ("ITW FEG") without charge and remains the property of ITW FEG, and by accepting this manual you agree that you will return it to ITW FEG promptly upon its request for such return at any time in the future.

TABLE OF CONTENTS

SERVICE UPDATES	3
OV520E SERIES RACK OVEN SERVICE UPDATES	3
IMPORTANT FOR YOUR SAFETY	4
IMPORTANT FOR YOUR SAFETY	4
GENERAL	5
INTRODUCTION	5
GENERAL	5
HEATING	5
STEAMING SYSTEM	5
UNPACKING	5
LOCATION	5
CLEARANCE DIMENSIONS	5
INSTALLATION CODES AND STANDARDS	6
SPECIAL TOOLS	6
OV520E RACK OVEN SPECIFICATIONS	6
HARDWARE REFERENCE GUIDE	6
INSTALLING OVEN	7
LOADING DOOR UNCRATING	7
OVEN SECTIONS	9
FLOOR / THRESHOLD - DOUBLE RACK OVEN	17
FLOOR / THRESHOLD - SINGLE RACK OVEN	19
STEAM SYSTEM - OV520E2	20
STEAM SYSTEM - OV520E1	22
LOADING DOOR INSTALLATION	24
DOOR HANDLE	25
DOOR ASSEMBLY / ADJUSTMENT	26
DOOR SWITCH ACTUATOR	29
DOOR SWEEP	29
RACK CARRIERS	30
RACK CARRIER - A & C STYLE RACK LIFT	30
RACK CARRIER - B STYLE RACK LIFT	32
VENT	34
HOOD ASSEMBLY	34
HOOD VENTING	36
AIR BAFFLE & GREASE FILTERS	37
CAULK OVEN	37
INITIAL STARTUP	38
FINAL CHECKS	39

SERVICE UPDATES

OV520E SERIES RACK OVEN SERVICE UPDATES

October 2022

- Generated new Installation Instructions manual.

IMPORTANT FOR YOUR SAFETY

IMPORTANT FOR YOUR SAFETY

THIS MANUAL HAS BEEN PREPARED FOR PERSONNEL QUALIFIED TO INSTALL ELECTRIC EQUIPMENT, WHO SHOULD PERFORM THE INITIAL FIELD START-UP AND ADJUSTMENTS OF THE EQUIPMENT COVERED BY THIS MANUAL

FOR YOUR SAFETY

DO NOT STORE OR USE GASOLINE OR OTHER FLAMMABLE VAPORS OR LIQUIDS IN THE VICINITY OF THIS OR ANY OTHER APPLIANCE

WARNING

IMPROPER INSTALLATION, ADJUSTMENT, ALTERATION, SERVICE OR MAINTENANCE CAN CAUSE PROPERTY DAMAGE, INJURY OR DEATH. READ THE INSTALLATION, OPERATING AND MAINTENANCE INSTRUCTIONS THOROUGHLY BEFORE INSTALLING OR SERVICING THIS EQUIPMENT.

IN THE EVENT OF A POWER FAILURE, DO NOT ATTEMPT TO OPERATE THIS DEVICE.
KEEP AREA AROUND OVEN CLEAR OF COMBUSTIBLES.
DO NOT OBSTRUCT COMBUSTION AND VENTILATION OPENING ON THE OVEN.

FOR YOUR SAFETY

AN ATTACHMENT POINT FOR FALL PREVENTION IS LOCATED ON TOP, IN THE CENTER OF THE OVEN. WHEN WORKING ON TOP OF OVEN, BE SURE TO SECURELY ATTACH SAFETY HARNESS TO FALL PREVENTION ATTACHMENT POINT.

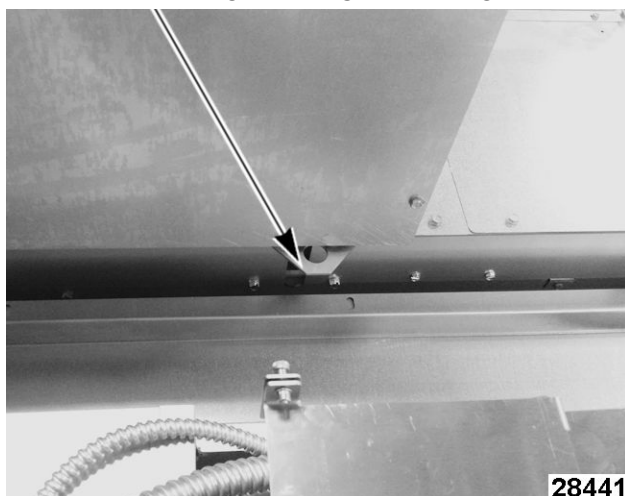

Fig. 1

GENERAL

INTRODUCTION

General

OV520E1 rack oven holds one single rack, and OV520E2 holds two single racks or one double rack.

Oven features:

- Powered rack lift with high temperature bearings and a clutch rotating system designed to stop the rack in the event of a jam without damage to the rotation motor or losing rack alignment.
- Touchscreen controller, flush flooring, and field reversible bake chamber door.

All of the information, illustrations and specifications contained in this manual are based on the latest product information available at the time of publishing.

Heating

The rack oven reaches baking temperatures of 350°F in approximately 20 minutes; however, a 30-minute preheat is recommended to fully heat the steam generator.

Steaming System

Standard on all rack ovens, is a self-contained spherical cast steam system providing excellent steaming conditions.

UNPACKING

NOTICE

Any shipping damage should be acknowledged in the presence of the freight carrier and noted on the freight bill. Shipping damage is not covered under warranty.

Remove the crating from the oven exterior, check for possible shipping damage. If the oven is found to be damaged after unpacking, save the packaging material and contact the carrier within 5 days of delivery.

NOTE: If the location has multiple ovens, keep the serial numbered crates together.

LOCATION

NOTICE

To reduce the risk of fire, the appliance is to be installed on non-combustible surface only, with no combustible material within 18 inches above the appliance. The appliance is to be mounted on floors of non-combustible construction with noncombustible flooring and surface finish and with no combustible material against the underside, or on non-combustible slabs or arches having no combustible material against the underside. Such construction shall in all cases extend not less than 12 inches beyond the equipment on all sides.

NOTE: CHECK FLOOR PER SPECIFICATIONS.

The floor must be level with surrounding area with a maximum slope of 1/8" per foot up to 3/4" maximum in all directions. Floor anchors require a minimum 1" thick solid floor substrate.

A level floor area must be prepared before assembling oven. The floor area should be at least 104"D x 74"W for double rack oven and 85"D x 57"W for single rack oven to accommodate the oven footprint and door swing. Check the facilities floor area at the threshold and door swing opening location to determine if facilities floor will need to be reworked.

NOTE: Review HOST course for laser level technique.

Do not obstruct the flow of combustion and ventilation air. Keep the appliance area free and clear from combustibles.

Make sure there is an adequate supply of make-up air in the room to allow for combustion.

The electrical diagram is located on the inside of the heat exchanger compartment door.

CLEARANCE DIMENSIONS

Oven is UL/CSA Listed for zero clearance for back and side walls. A 1" to 4" back clearance is recommended for plumbing rear drain connection.

Top of oven requires a minimum of 24" clearance for servicing accessibility.

INSTALLATION CODES AND STANDARDS

OV520 ovens must be installed in accordance with:

United States

1. State and local codes.
2. ANSI/NFPA 96, Standard for Ventilation Control & Fire Protection of Commercial Cooking Operations (latest edition), available from National Fire Protection Association, Batterymarch Park, Quincy, MA 02269.
3. National Electrical Code, ANSI/NFPA-70 (latest edition).
4. NSF/ANSI 4 - 2007e Standard for Commercial Cooking, Rethermalization and Powered Hot Food Holding & Transport Equipment.

Canada

1. Local codes.
2. CAN/CGA-B149-1, Installation for Natural Gas Burning Appliances and Equipment (latest edition).
3. CAN/CGA-B149-2, Installation for Propane Burning Appliances and Equipment (latest edition).
4. Canadian Electrical Code, Part 2, CSA Standard C22.1 (latest edition).

Plumbing Connections

1. Water and waste piping and connections shall comply with the International Plumbing Code 2003, International Code Council (ICC), or to the Uniform Plumbing Code 2003, International Association of Plumbing and Mechanical Officials (IAPMO).

NOTE: Plumbing connections must comply with applicable sanitary, safety and plumbing codes and provide adequate backflow protection to comply with applicable federal, state, and local codes.

SPECIAL TOOLS

- Inclined manometer - Dwyer Cat. #1227 or equivalent.
- Rotary hammer / hammer drill to drill holes in floor for anchor bolts.
- 3/8" masonry drill bit to drill holes in floor for anchor bolts.

- Temperature probe (thermocouple type) with 10' lead.
- Gauges for checking air shutters (shipped with oven).
- Dolly wheel (front).
- Mini laser level, self-leveling with tripod.
- 2-ton capacity foldable shop hoist for lifting oven section.
- 3/8" chain 20 ft. long with a 4700 lbs. minimum load rating used with hoist.
- Inch-pounds torque wrench.
- Two 7/16" X 5-1/2" bolts used with hoist.
- Two 7/16" nuts used with hoist.
- Four 7/16" fender washers used with hoist.
- Loctite® #242.
- NSF 51 listed high temp red silicone (shipped with oven).
- NSF 51 listed gray silicone (shipped with oven).
- Drywall cart/dolly.
- J-bar.
- 1/4" Drop-In Anchor Set Tool (3/16" Tip) (not shipped with oven).

OV520E RACK OVEN SPECIFICATIONS

The following specification sheets are available on the Resource Center.

- [Spec Sheet: OV520E1 Rotating Single Rack Oven - Electric](#)
- [Spec Sheet: OV520E2 Rotating Double Rack Oven - Electric](#)

HARDWARE REFERENCE GUIDE

[Rack Oven Hardware Reference Guide](#)

INSTALLING OVEN

This manual is written for a new installation where you can position the oven sections while the oven is on the shipping skids. Some installations may require that oven sections on the skids be lifted on their sides and manipulated through doorways prior to positioning sections for installation.

Prior to installing the oven, check facilities floor for levelness per specifications. See LOCATION, and refer to Pre-Installation site inspection performed by Installing office.

NOTE: It is recommended that first-time installers take the OV500 Rack Oven Installation program on HOST prior to participating in the installation.

LOADING DOOR UNCRATING

⚠ WARNING

Use appropriate safe lifting precautions when handling loading door. Using four or more people is recommended; weight is in excess of 200 lbs.

The loading door must be removed prior to lifting the oven sections. See the following details on oven door removal.



Fig. 2

1. Remove crating material from the oven.
2. Remove mounting brackets that hold oven door in place on skid.

NOTE: Save hardware (6 screws per bracket) for use on front dolly wheel.

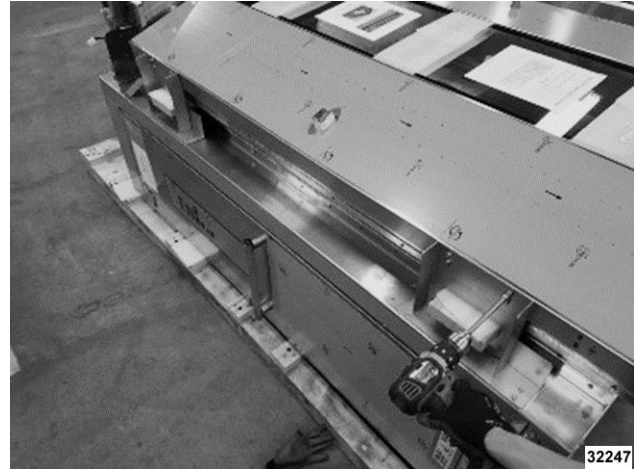

Fig. 3

NOTICE

Use a large piece of cardboard or equivalent on drywall cart/dolly in order to protect door from being scratched when placing it on cart/dolly.

3. Remove door from top of oven sections.
 - A. Use two people to slide door along the 2x6 shipping board on which the door is supported.
 - B. Once there is enough room to access the latch side of the door, use four people to lift the door off the 2x6 board and lower it onto the cart/dolly. Make sure there is sufficient protection on the cart/dolly to avoid scratching or damage to the door (Fig. 4, Fig. 5, Fig. 6).

NOTE: Be mindful of sharp metal edges and corners on the oven.

NOTE: Use proper PPE when removing door from oven section.



Fig. 4



Fig. 5



Fig. 6

4. Secure door to cart/dolly to keep it stable (Fig. 7), then move it aside until needed, ensuring door is protected from damage while storing.



Fig. 7

5. Remove remaining mounting brackets, backing plates, screws, and 2 x 6 planks, and then discard.

NOTE: Hold backing plate (Fig. 8) while removing bracket (Fig. 9) to prevent plate from dropping into the oven.

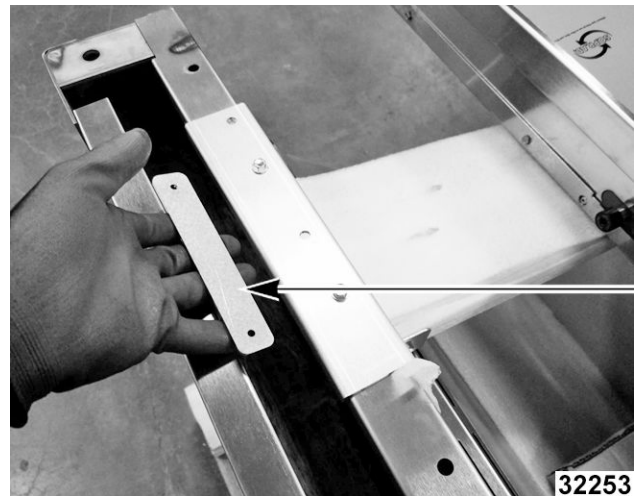

Fig. 8

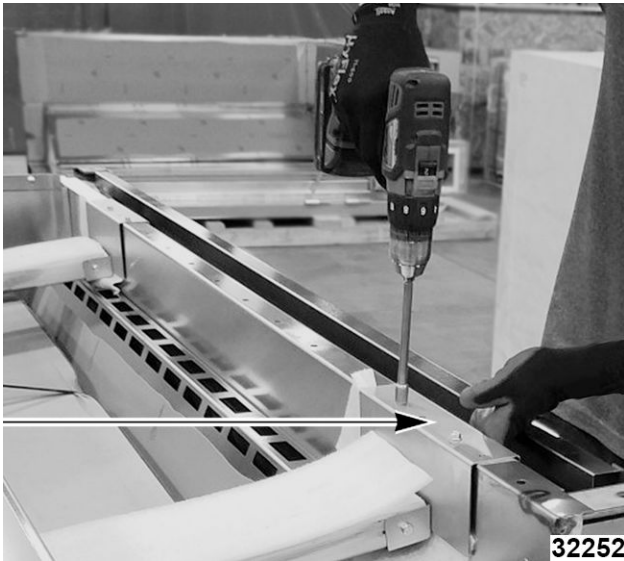

Fig. 9

NOTE: Hinge and ramp hardware are located in the parts box.

NOTE: Be sure to verify all parts in parts box are accounted for before beginning installation. Retain sign-off sheet for missing part numbers.

OVEN SECTIONS

NOTICE

It is essential that correct hardware is used in the designated locations. Refer to the [HARDWARE REFERENCE GUIDE](#) for hardware descriptions.

Remove all assemblies except oven sections from skids prior to lifting oven sections.

1. Place the oven sections as close to the final position as possible, allowing enough room to work, with the sections positioned for lifting.
 - A. Check for ceiling clearance (minimum 113" with oven tilted up on the skid). The oven is tallest when it is approximately 60 degrees to the floor during the raising process. If oven section has been turned on its narrow side in order to navigate through a doorway, turn the oven section back to the shipping position prior to raising.
 - B. Remove the bottom hold down brackets from both pallets, but do not remove oven sections from pallets.

WARNING

DO NOT remove the two top brackets prior to lifting units.

2. Lift the oven sections upright using the hoist technique (lift instructions covered in HOST rack oven lift program). Both oven sections should be as close as possible, but not touching.

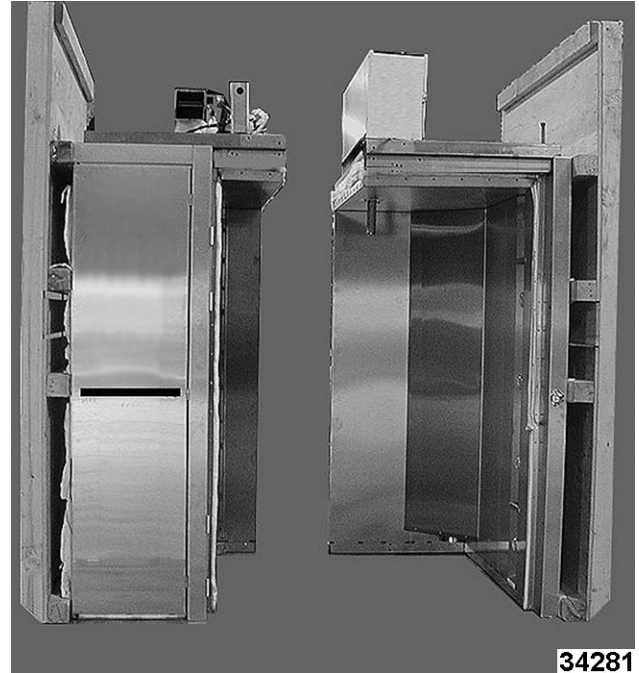

Fig. 10

3. Once the oven is in the upright position, remove the top two brackets securing the oven to the skid.



Fig. 11

⚠ WARNING

The Z bracket location on the bottom of the skid must be disengaged before lowering the skid. If engaged when lowering the skid, the oven section could fall.

- A. Pull the bottom of the skid away from the oven to clear the Z bracket.

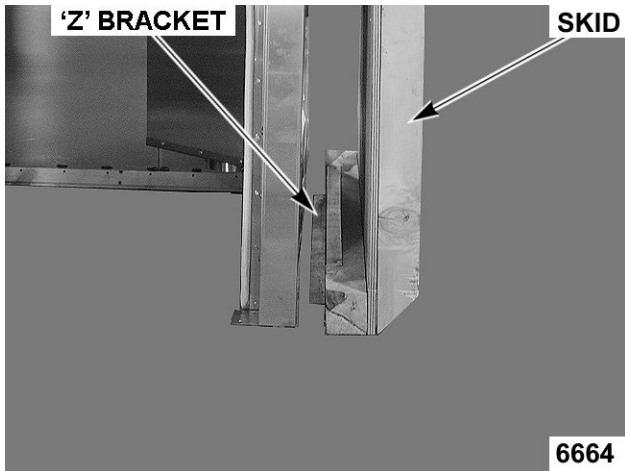

Fig. 12

- B. Lower the skid to the floor making sure that the Z bracket does not scratch the oven side.
 - C. Perform the same procedure for other oven section.
4. Remove the header support bracket.
- A. Remove the two screws from hinge side of bracket.
 - B. Remove the single screw from the header side of bracket and discard screw and bracket.

REMOVE HEADER SIDE SCREW

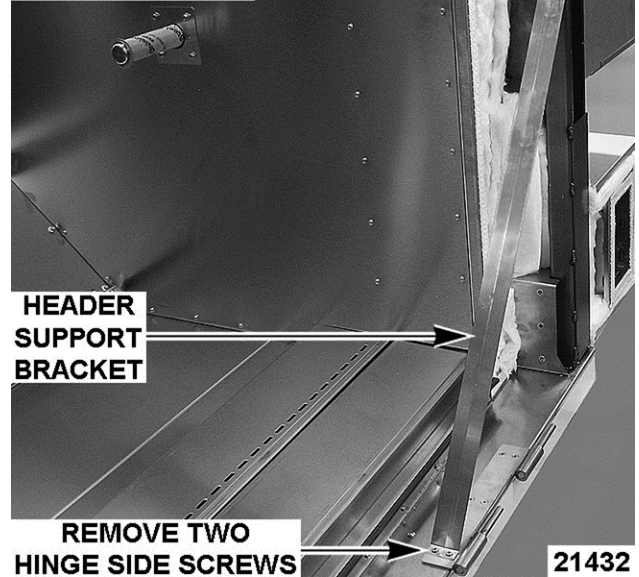

Fig. 13

NOTE: For single rack ovens, floor is a single piece, and must be installed before sliding the two sections together.

- 5. Slide the oven sections together.

NOTE: Use high temp red silicone to caulk entire inner seam before placing halves together.



Fig. 14

NOTE: Center seam **MUST** be caulked with high temp red silicone prior to pushing oven halves together.

NOTE: Ensure ceiling offset flange slides under opposite oven section ceiling.

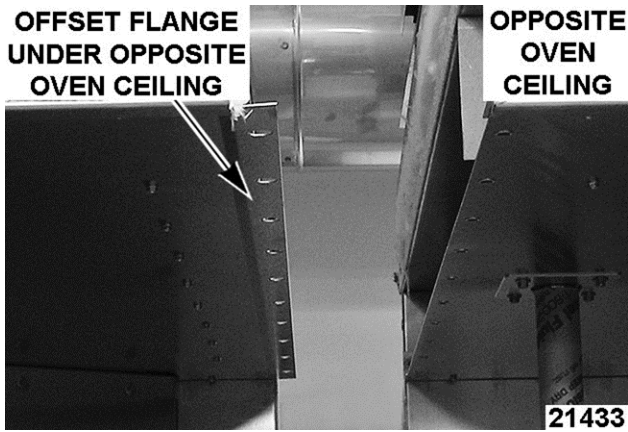

Fig. 15

6. Install 1/2-13 x 1-1/2" bolt with lock washer and nut in rear frame connection points of oven, both top and bottom.

NOTE: Hand tighten all nuts, bolts, and screws until all screws have been installed. Ensure all oven sections are aligned before tightening nuts, bolts, and screws.

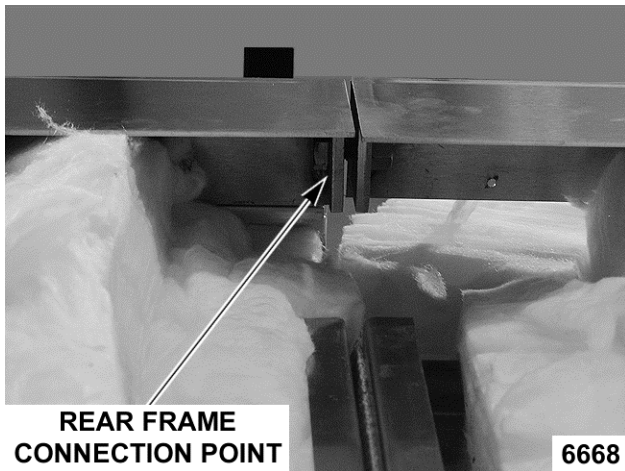

Fig. 16

7. Install 5/16-18 x 1" gimlet screws in upper & lower header connections.

NOTE: Ensure oven sections upper header front surfaces are flush.

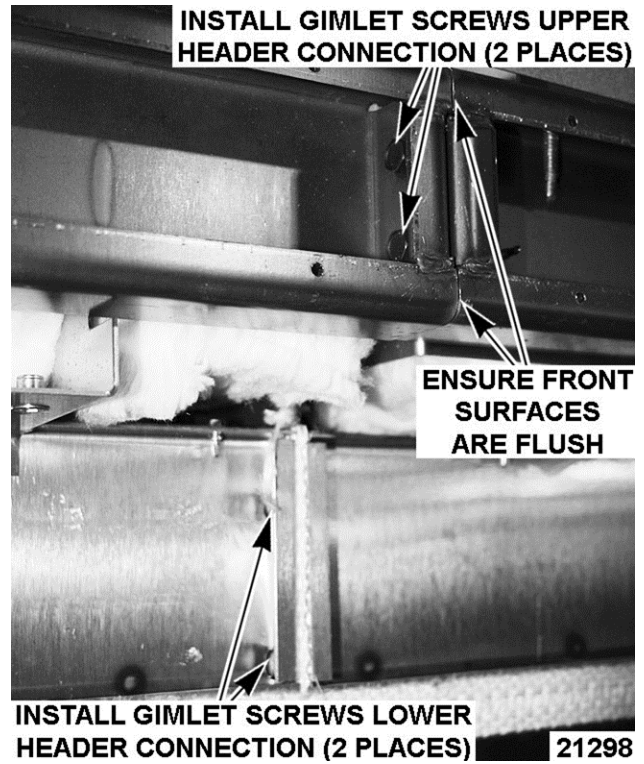

Fig. 17

NOTE: If you have trouble aligning the holes in the rear frame, you may have to manipulate the oven sections using the levelers, using shims, or by prying. Use care not to damage building floor.



Fig. 18

NOTE: You may have to move oven front corners to make the holes in the outer header align with the holes in the oven.



Fig. 19

8. Install 5/16-18 X1" gimlet screws in the flanges of the mating sections around the oven perimeter, both top and back.

NOTE: Start a few screws at several locations around the flange to help align the flange holes.

9. Install all flange mating section screws and ensure mating surfaces are flush in the interior & exterior of the oven before tightening the screws.

NOTE: If you have trouble aligning the mating holes in the flange, you may have to manipulate the oven sections using the levelers or by prying.

FLANGE MATING SECTION AT BACK OF OVEN



Fig. 20

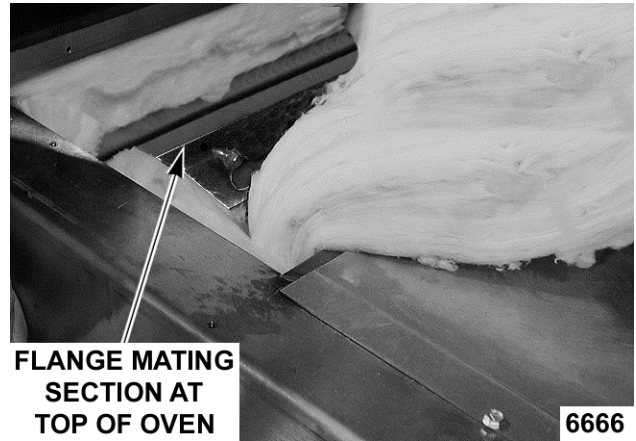

FLANGE MATING SECTION AT TOP OF OVEN

Fig. 21

10. Install insulation in channel.
11. Install upper header support plate with #10 Tek screws.



UPPER HEADER SUPPORT PLATE INSTALLED

Fig. 22

12. Install header cover with #10 X 3/4" screws on top and 1/4-20 x 3/4" hex head serrated flange screws on bottom. Verify that the front edge of cover is flush with door jambs.

NOTE: If header cover does not fit, **DO NOT** attempt to cut or grind the cover. This is an indication of an issue with assembly. Contact Bakery Product Support.



Fig. 23

13. Install door gaskets to gasket retainers.

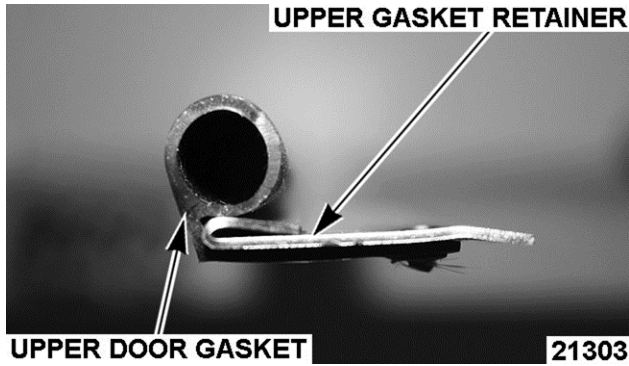

Fig. 24

- A. Cut off gasket material to length of retainer.
- B. Install door gasket / gasket retainer by securing gasket and retainer to header cover and jambs with 10-32 gimlet screws.



Fig. 25

14. Install 1/4-20 X 3/4" hex head serrated flange screws onto ceiling offset inside baking compartment. Torque screws to a maximum 75 in-lb.

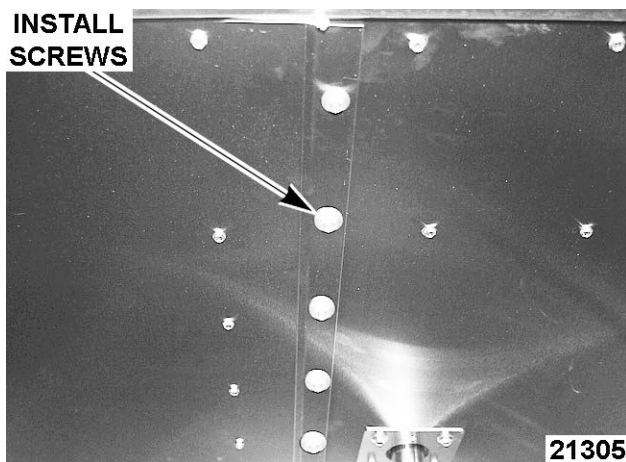

Fig. 26

15. Install insulation pieces.

- A. On the rear seam, bend the copper studs so they are 90 degrees to the oven wall. When installing the insulation, make sure the insulation is held by these studs.

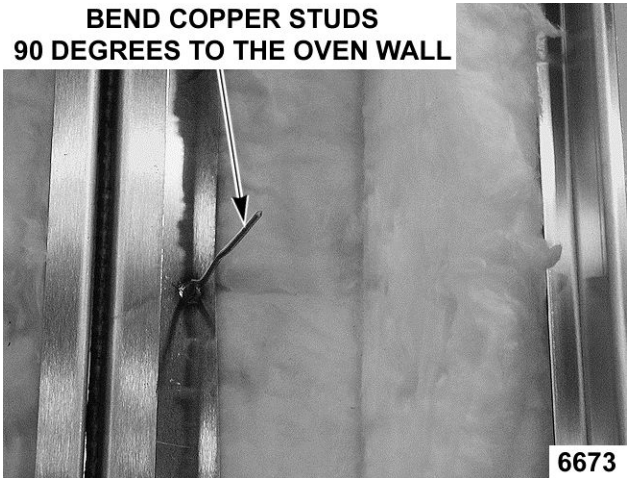

Fig. 27

- B. At the rear wall, place the push nuts over the copper studs to secure the insulation.

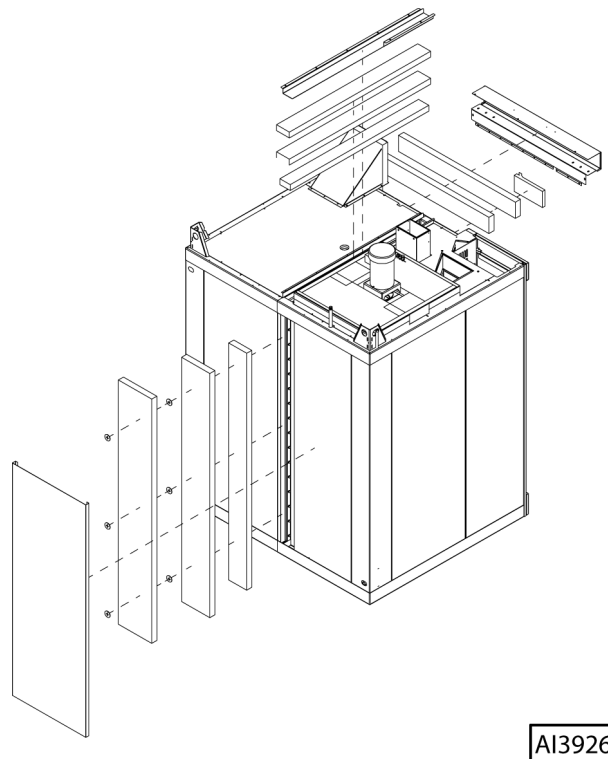

Fig. 28

16. Install rear cover panel.

- A. Start the top of the panel behind the top rail of the upper frame.



Fig. 29

- B. Push the panel up until the bottom of the panel clears the bottom rail of the oven section frame.

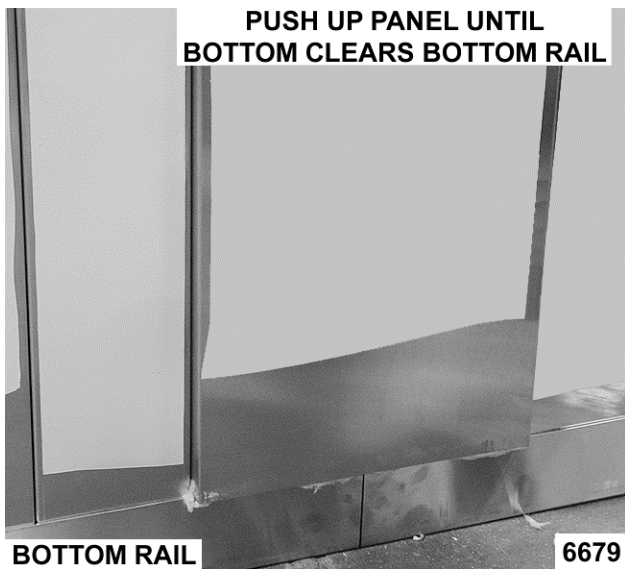

Fig. 30

- C. Make sure that the panel is behind the rail of the lower frame and will rest against the stop when lowered into position.
- D. Push the panel down against the stop.



Fig. 31

- 17. Connect rear drain if required.
 - A. Ensure drain slopes downward 1/4" per foot.
- 18. Install insulation into ceiling channel.



Fig. 32

- 19. Install ceiling channel cover with #10 Tek screws over the ceiling channel.



Fig. 33

20. Connect plug for rack rotation and rack lift to service entrance box.

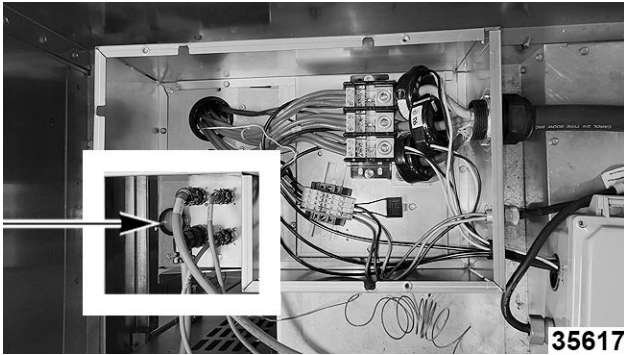

Fig. 34

21. If rear drain of oven is used install before oven is placed in final location.
22. Remove protective plastic from rear and sides of the oven that won't be accessible once the oven is in place.

NOTE: Do not damage building floor while installing dolly wheel or using front levelers. Use shims under floor levelers to prevent damage to building floor.

23. Install the dolly wheel (not supplied with the oven).

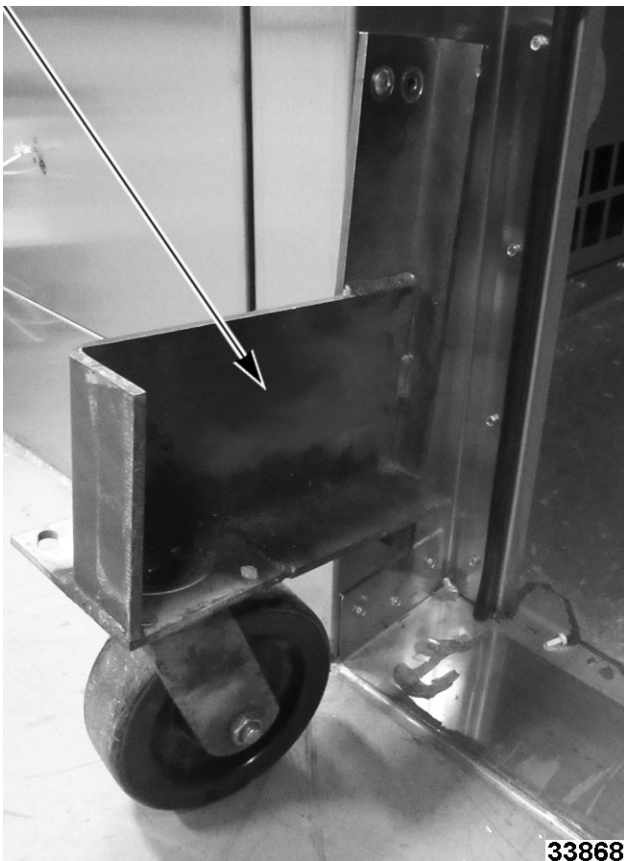

Fig. 35

NOTE: You may have to use the front levelers to raise the front of the oven to install the dolly wheel. Use care not to damage building floor.

- A. Raise the front oven levelers so the weight of the oven is on the dolly wheel.

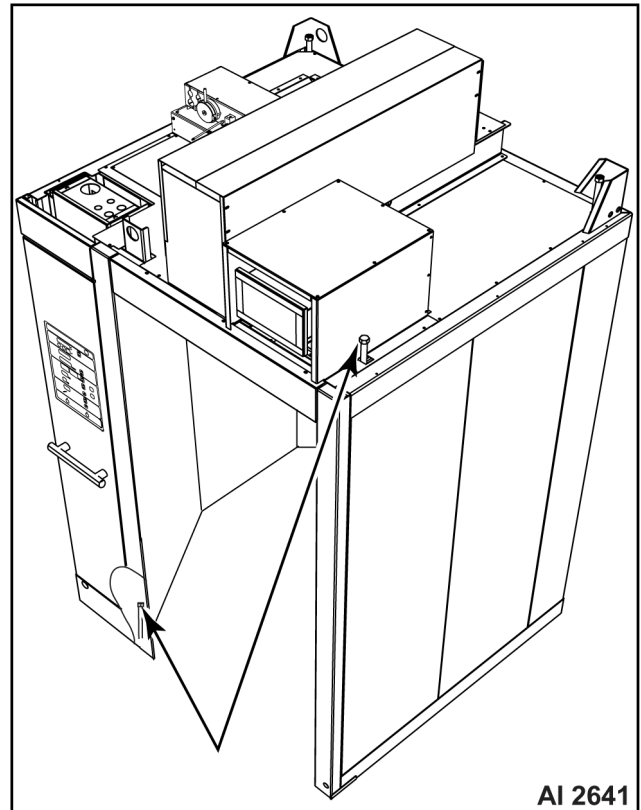

Fig. 36

- B. Lower the rear wheels to raise the back of the oven off the floor.

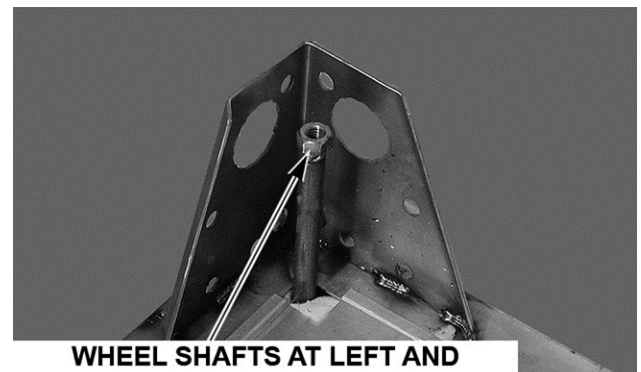

Fig. 37

NOTE: Raising the rear of the oven too much can cause the front of the oven to contact the floor.

24. Move the oven into the final position.
25. Place shim(s) per the height determined by the laser level technique to level oven.

NOTE: If shims are required to level the oven at the rear corners, place shim(s) in front of the back wheels. If the rear of the oven is not accessible, place shims under heat exchanger floor and inner wall base angle.

NOTE: Review HOST course for laser level technique.

NOTE: After oven is leveled and shimmed, raise the levelers to take the oven weight off all the levelers.

26. Raise the back wheels to lower the oven. Weight of oven should be completely off back wheels.

27. Remove the dolly wheel and replace lower latch ramp.

NOTE: Retain the dolly wheel for future oven installations.

28. Place threshold into door jamb.

NOTE: Do not anchor threshold at this time.

29. Verify door opening is square.

- A. Measure diagonal 'X' from top right innermost hinge screw to the bottom innermost hinge screw on the left door jamb.

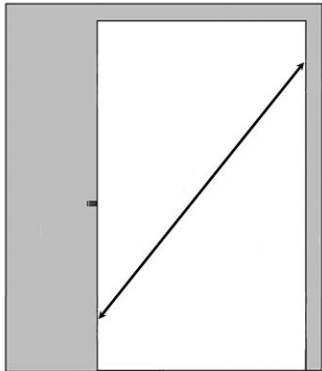

Fig. 38

10793

- B. Measure diagonal 'Y' from the top left innermost hinge screw to the bottom innermost hinge screw on the right door jamb.

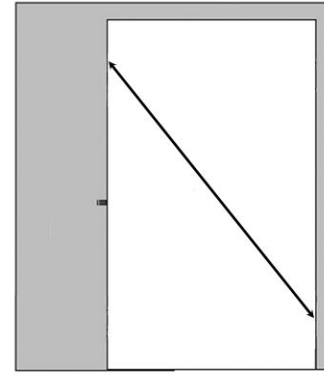

Fig. 39

10794

- C. If diagonal measurements are not within 1/8" of each other add additional shims as needed.
 - 1) If diagonal 'Y' measurement is greater than diagonal 'X' measurement, add shims under the right front door jamb. Place shims on top of threshold underneath the door jamb.

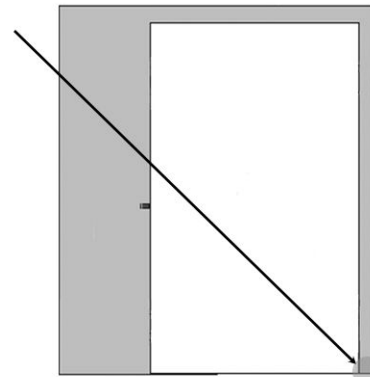

Fig. 40

10795

- 2) If diagonal 'X' measurement is greater than diagonal 'Y' measurement, add shims under the left front door jamb.

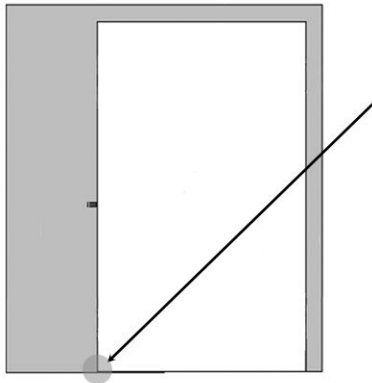

Fig. 41

10796

- D. Repeat procedure until diagonal measurements are within 1/8" of each other.

NOTE: If shims are required to level the oven at the front right corner, shims(s) will need to be placed on top of threshold underneath the door jamb.

NOTE: If shims are required to level the oven at the rear corners, place shim(s) in front of the back wheels. If the rear of the oven is not accessible, place shims under heat exchanger floor and inner wall base angle.

- 30. Remove bolts securing steam panel to oven.

- A. Lift panel up while tilting top of panel towards center of oven to remove from oven.



Fig. 42

33863

- 31. Remove screws securing drain pan cover to oven.

NOTE: DO NOT DISCARD HARDWARE.

- A. Pull cover out from suction panel while lifting up right side of cover then pushing cover towards the right rear corner of baking compartment and out from oven.

NOTE: Use care when removing cover not to scratch baking compartment walls.

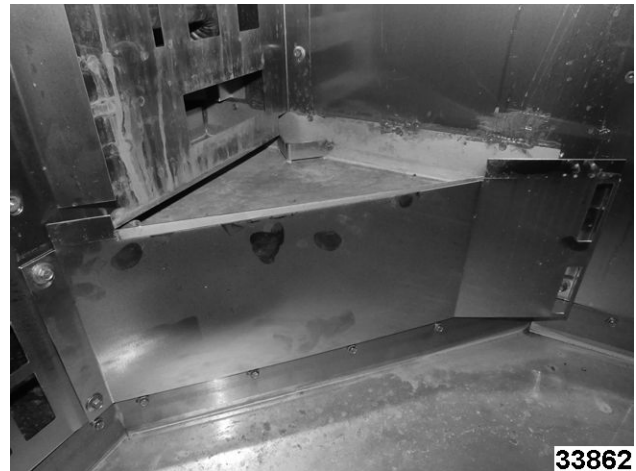

Fig. 43

33862

- 32. Lower drain pan support bolt until bolt comes in contact with the floor.

NOTE: Bolt used to support steam mass.

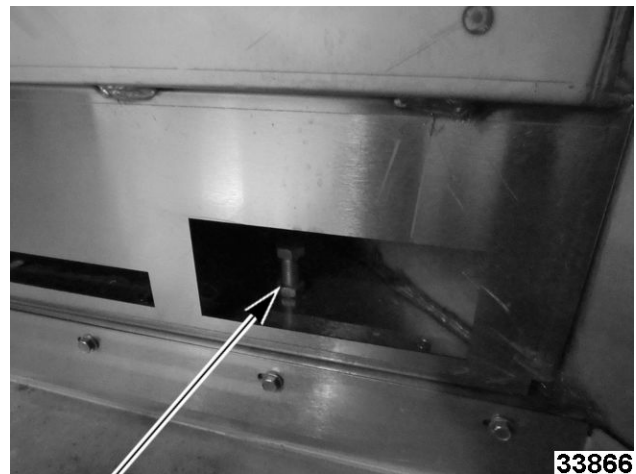

Fig. 44

33866

- 33. Install drain pan cover.

FLOOR / THRESHOLD - DOUBLE RACK OVEN

1. Move threshold halfway out from oven.
2. Caulk around bottom of baking compartment walls to facility floor seam with high temp red silicone.

NOTE: The sealant used inside the oven cavity must be NSF Listed; suitable for food zone and minimum 275°C/525°F. The sealant used on the exterior of the unit must be NSF 51 Listed.



Fig. 45

3. Run a bead of high temp red silicone on the entire outer edge of both floor panels (1, Fig. 46).
4. Install floor panel without offset (2, Fig. 46). Flange goes up.

NOTE: Use of hammer and 2x4 might be required to ensure corners of floor panel are seated to corners of oven cavity.

5. Run two beads of high temp red silicone (3, Fig. 46) on the flange of floor panel without offset.
6. Install remaining floor panel (4, Fig. 46) with offset (5, Fig. 46). Flange goes up.

NOTE: Use of hammer and 2x4 might be required to ensure corners of floor panel are seated to corners of oven cavity.

OV520G2 & OV520E2 FLOOR PANELS

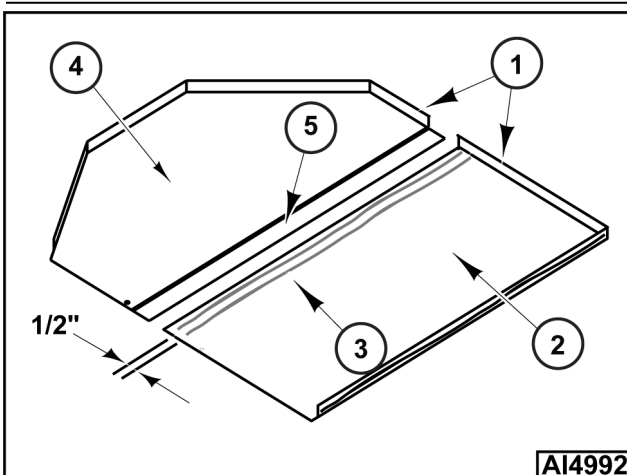

Fig. 46

7. Slide threshold under door jamb. Ensuring the three threshold tabs are installed over the oven floor.

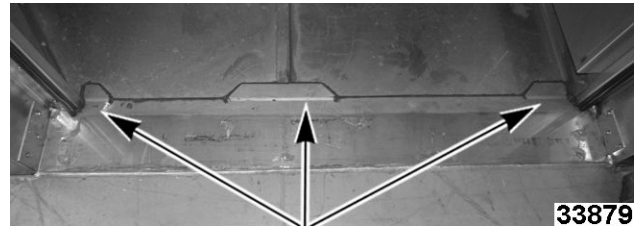

Fig. 47

NOTE: Use a hammer and 2X4 to tap threshold against oven floor. A 1/8" gap between oven floor and threshold is acceptable.

NOTE: If shims were required to level oven and square the door jamb at the front right corner, place shim(s) on top of threshold underneath the door jamb. Threshold is approximately one shim thick.

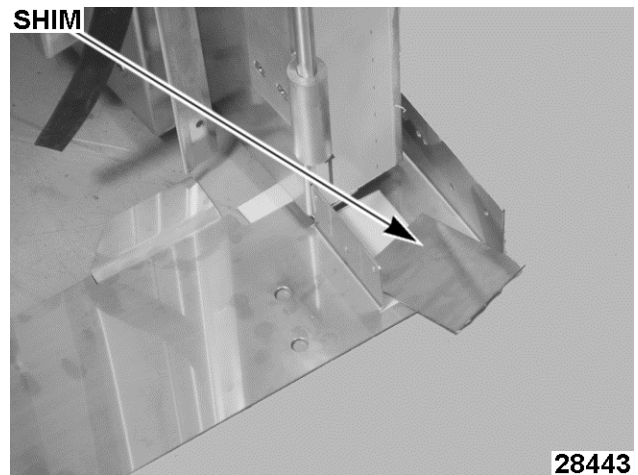

Fig. 48

8. Use high temp red silicone to seal the top edge of the floor's flanges, prior to installing floor trim.



Fig. 49

NOTE: Left side, rear wall, and right side floor flanges need to be caulked with silicone.

9. Install floor trim. Wait until later in the procedure to tighten screws.



Fig. 50

10. Drill and tap into door jamb using holes in threshold as guides.

NOTE: Verify door jamb is still square before drilling and tapping holes for securing threshold to door jamb.

- A. Secure threshold to door jamb with 10-32 X 3/4" flanged screws, secure left side first.



Fig. 51

11. Anchor threshold to facility floor.

- A. Use appropriate screw length, depending on anchor depth.

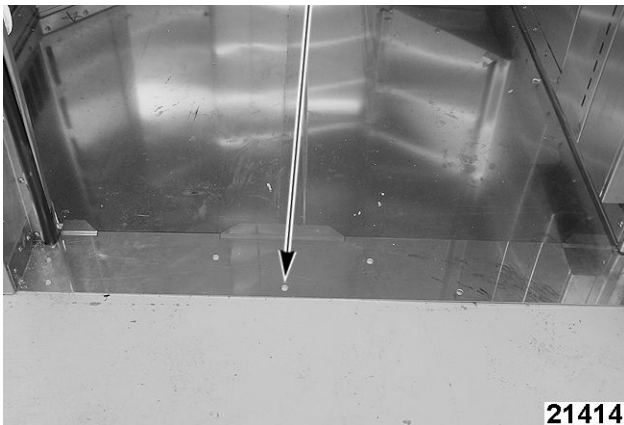

Fig. 52

12. Tighten floor trim screws.
13. Caulk gap between oven floor and threshold with gray NSF 51 listed silicone.

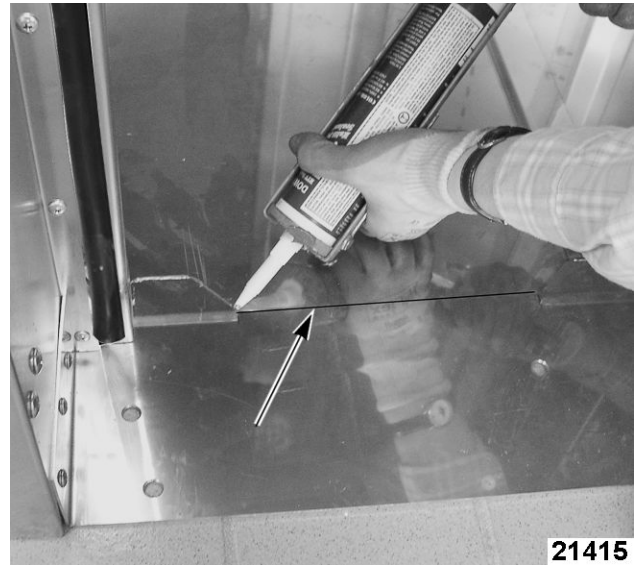

Fig. 53

14. Caulk door jamb gaps with gray NSF 51 listed silicone.



Fig. 54

FLOOR / THRESHOLD - SINGLE RACK OVEN

NOTE: The sealant used inside the oven cavity must be NSF listed; suitable for food zone and minimum 275°C/525°F. The sealant used on the exterior of the unit must be NSF 51 listed.

1. After oven is leveled and shimmed, remove screws and washers holding the floor in place.

NOTE: If shims were required to level oven and square the door jamb at the front right corner, place shims(s) on top of threshold underneath the door jamb. Threshold is approximately one shim thick.



Fig. 55

2. Use red NSF 51 listed silicone to seal the top edge of the floors flange, prior to installing floor trim.

NOTE: Left side (Fig. 56), rear wall, and right side flanges need silicone application.



Fig. 56

3. Install floor trim. Wait until later in the procedure to tighten screws.
4. Anchor oven floor (9 places total) to facility floor (Fig. 57).

NOTE: The four anchors in the middle of the floor require the use of tapered washers, which will allow the floor to move.

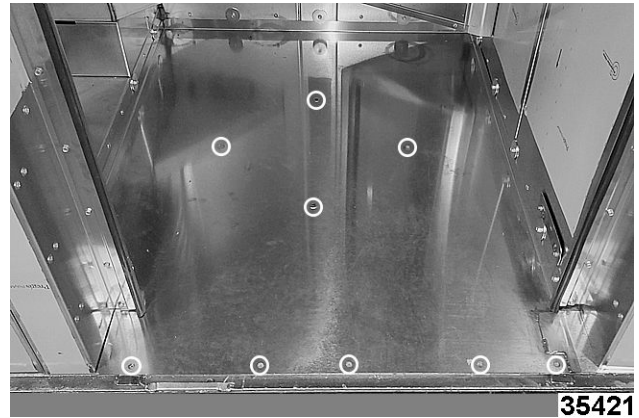

Fig. 57

5. Tighten floor trim screws.
6. Caulk door jamb gaps with gray NSF listed silicone.

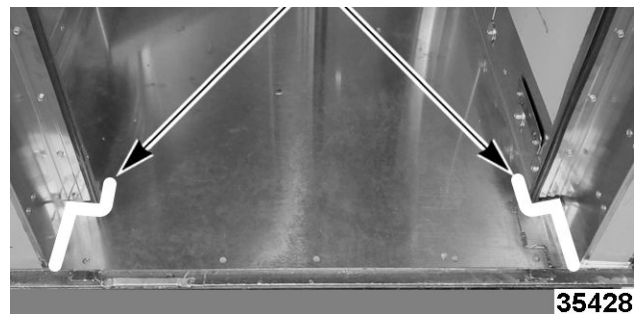

Fig. 58

STEAM SYSTEM - OV520E2

1. Run a bead of high temp red silicone between drain pan and rear oven wall behind splash guard to form a seal.

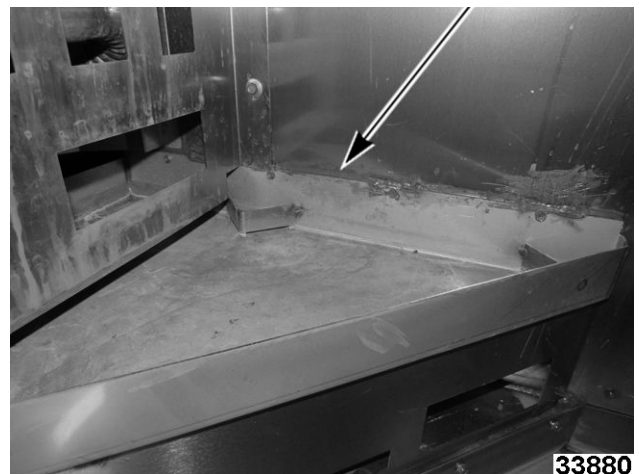

Fig. 59

NOTE: Make sure drain pan is level front to rear and side to side prior to stacking steam ball assemblies. If drain pan is not level, contact Bakery Product Support.

- Start by setting the first steam ball assembly flat on the oven baking compartment floor (left rear corner).

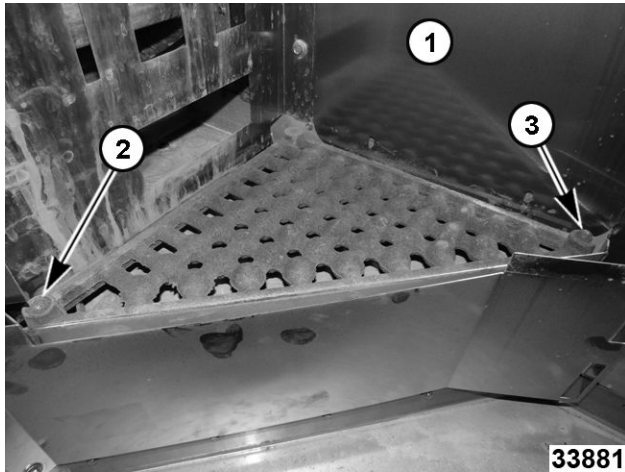

Fig. 60

- The next steam ball assembly must be put in place matching the female post (2, Fig. 60) with male post (3, Fig. 60) of previous assembly. (1, Fig. 60, splash panel.)

NOTE: The assemblies will not sit level if the sections are not oriented correctly.

OVEN	NUMBER OF PIECES
OV520E2	28 PCS

NOTE: For SEF ovens, pieces may vary.

- Begin with the top assembly and install water guides over front rim of the top, then every other assembly (total of 7 water guides for all ovens).



Fig. 61

- After all assemblies are installed, place spray guard on last set of steam balls and install water guides to edge of assemblies.

NOTE: Sprayer must be vertically centered above castings.

NOTE: Spray guard must be centered on castings, or water will spray onto floor.



Fig. 62

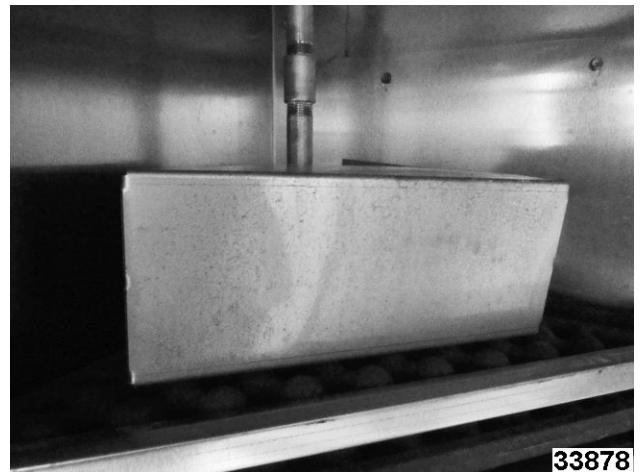

Fig. 63

- Install left baking compartment panel.
- Align steam panel with screw inserts in baking compartment ceiling (left rear corner) and loosely secure panel to ceiling with 1/4-20 X 3/4" hex head serrated flange screws previously removed.

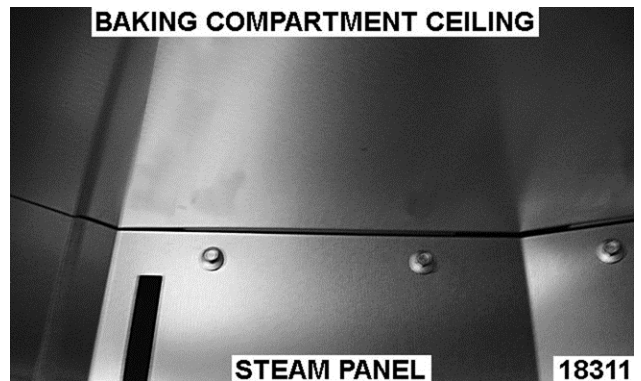

Fig. 64

- Secure steam panel to rear baking compartment panel with 1/4-20 X 3/4" hex head serrated flange screws. Torque screws to a maximum 75 in-lb.



Fig. 65

- Secure steam panel to left baking compartment panel with 1/4-20 X 3/4" hex head serrated flange screws. Torque screws to a maximum 75 in-lb.



Fig. 66

- Tighten screws at top of steam panel. Torque screws to a maximum 75 in-lb.

STEAM SYSTEM - OV520E1

- Run a bead of high temp red silicone between drain pan and rear oven wall.

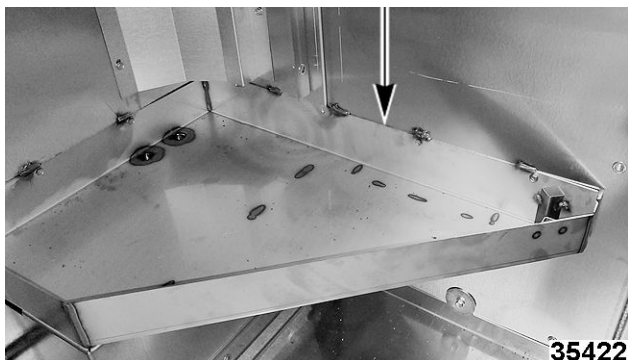

Fig. 67

- Start by setting the first steam ball assembly flat on the oven baking compartment floor (left rear corner).

NOTE: For OV520G1 ovens, place steam ball assembly on spacers (Fig. 68) to obtain correct height.

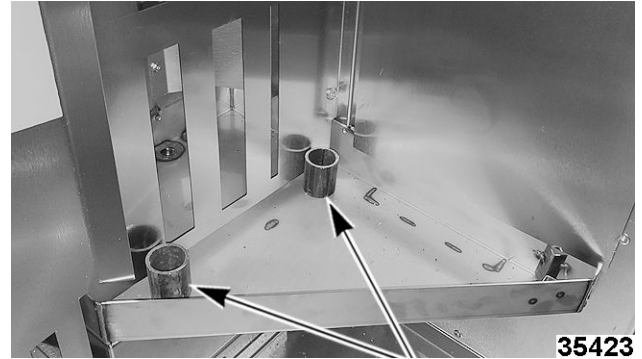

Fig. 68

- The next steam ball assembly must be put in place matching the female post (1, Fig. 69) with male post of previous assembly.

NOTE: The assemblies will not sit level if the sections are not oriented correctly.

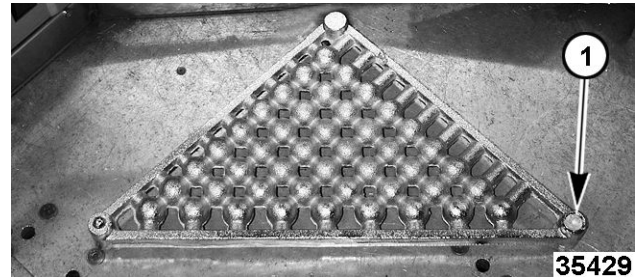
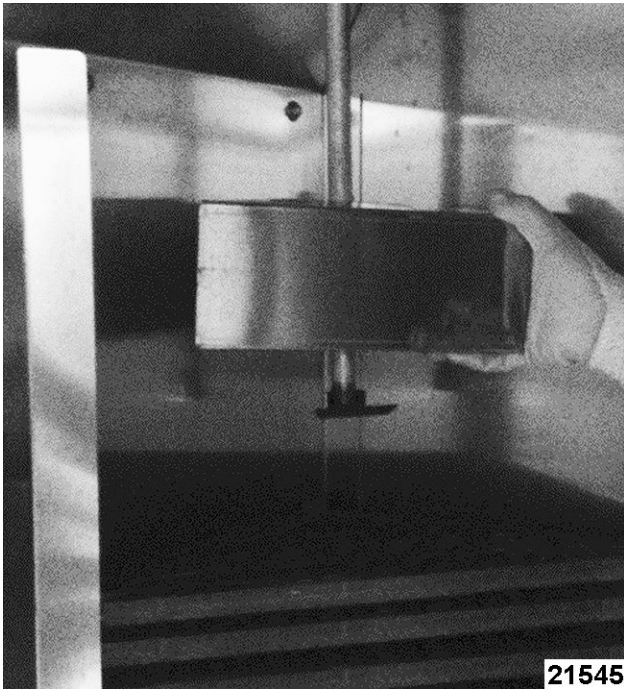

Fig. 69

OVEN	NUMBER OF PIECES
OV520E1	20 PCS

NOTE: For SEF ovens, pieces may vary.

- Before last couple sets of assemblies are installed, slide spray guard onto manifold. Align manifold with steam ball assemblies. Allow spray guard to hang on manifold.



21545

Fig. 70

5. Begin with the top assembly and install water guides over front rim of the top, then every other assembly (total of 7 water guides for all ovens).
6. After all assemblies are installed, place spray guard on last set of steam balls (Fig. 72) and install water guides to edge of assemblies (Fig. 71).

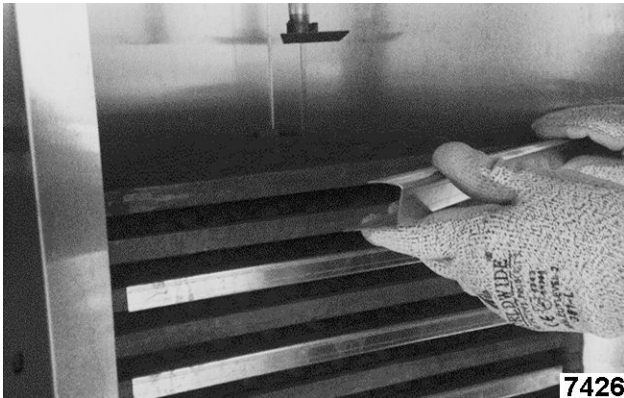

7426

Fig. 71



SPRAY GUARD INSTALLED

7428

Fig. 72

7. Install left baking compartment panel.
8. Secure steam panel to rear baking compartment panel with 1/4-20 X 3/4" hex head serrated flange screws.



21420

Fig. 73

9. Secure steam panel to left baking compartment panel with 1/4-20 X 3/4" hex head serrated flange screws.



STEAM PANEL

BAKING
COMPARTMENT
LEFT WALL

18313

Fig. 74

LOADING DOOR INSTALLATION

1. Move door on cart/dolly close to the oven, and position pallet jack nearby.

NOTE: If hinge side is up on cart/dolly, perform Step 4 before Step 2. If hinge side is down, proceed through the following steps.

2. Using multiple people, tip door off cart onto floor (Fig. 75).



Fig. 75

3. Raise edge of door and position on pallet jack (Fig. 76).

NOTE: Be sure to use at least three people to raise door and stabilize pallet jack.



Fig. 76

4. Install hinges and roller ramps:
 - A. Attach hinges with pivot pins to right door jamb, using 1/4-20 flat head screws.

NOTE: If door needs to be attached to the left door jamb, the pins can be reversed. (Door linkage will also need to be rotated for the door to work properly.)

- B. Place brass washers onto hinge pins.
- C. Attach hinges without pivot pins onto the door.

NOTE: Leave slightly loose to help with hinge alignment during door installation.

- D. Attach roller ramps (Fig. 77). (Additional 1/4-20 pan head screws are added to close up all unused holes on jambs.)

NOTE: Adjust ramps away from gasket at this time.



Fig. 77

5. Move pallet jack with door into place near oven, at a 90-degree angle to oven front, and line up door hinges with jamb hinge pins (Fig. 78).

NOTE: Make sure brass washers have been added.



Fig. 78

6. Gently lower door into place.
 - A. Adjust door away from gaskets at this time.
7. Verify all screws on jamb hinges are fully tightened (Fig. 79).

NOTE: Door hinge screws might need to be loosened to adjust door toward gasket. See [Door Hinge Adjustment](#).



Fig. 79

8. Use a J bar placed close to the hinge side of the door to slightly raise the door, allowing room for pallet jack to be pulled out from under door.

NOTICE

DO NOT place J bar underneath the glass of the door

9. With the door open, visually check if door swings on its own.

NOTICE

DOOR MUST NOT SWING ON ITS OWN IN EITHER DIRECTION. IF IT DOES, THIS IS AN INDICATION THAT THE DOOR IS NOT HUNG LEVEL AND PLUMB. DOOR SWEEPS SHOULD NOT BE USED TO PREVENT DOOR FROM MOVING.

DOOR HANDLE

1. Remove door handle packaging from inside the outer door glass compartment and close compartment door.
2. Remove pivot screw from door handle pivot bracket on door assembly.

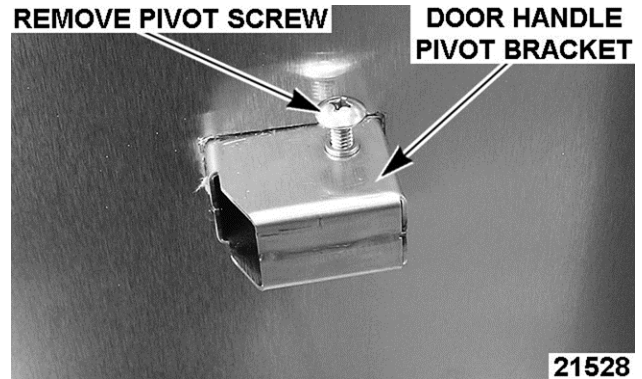

Fig. 80

3. Install door handle onto pivot bracket and insert screw removed earlier. Add Loctite to threads.



Fig. 81

4. Push door handle locking end onto door handle locking mount until handle locks onto mount.

NOTE: Ensure lock mechanism is in the unlocked position.

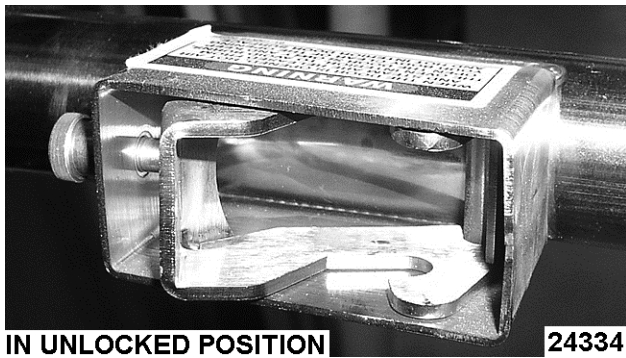

Fig. 82



Fig. 83



Fig. 84

DOOR ASSEMBLY / ADJUSTMENT

1. Verify all door hinge screws are tight, and then observe the following:
 - A. With the door closed, visually check gap around door jamb and edge of door, gap should be equal on both sides.

NOTE: If the door rubs against the jamb or drags the facility floor when opening, verify oven is level. If leveling does not correct the problem, then call Bakery Product Support.

- B. Adjust door hinge inward or outward until door has an airtight seal against door gasket.

NOTE: Only the hinge half attached to the door is adjustable.

NOTE: Pulling on a piece of paper placed between the door and gasket when door is fully closed can help verify if door is adjusted correctly. If there is a slight resistance when the paper is pulled, the door is adjusted correctly. If adjustment is required, adjust hinge side first.

DOOR HINGE ADJUSTMENT

DOOR ADJUSTED TOWARD GASKET **DOOR ADJUSTED AWAY FROM GASKET**

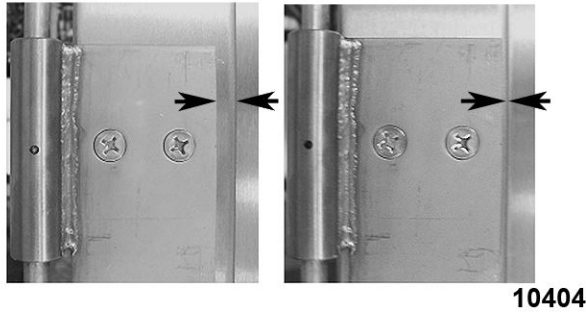

Fig. 85

NOTE: Latch alignment instructions are included with ramps to help align door rollers with latch ramps during installation. This should be done after loading door is installed and the oven is level.

2. To align door latches:

A. With both door latch ramps having gauge installed.

NOTE: Use vertical lines for adjusting the ramps so the rollers hit at the same time.

NOTE: If necessary, use horizontal lines to help select the proper height of the rollers.

NOTE: Changing of latch arms may be required. Additional latch arms are located inside the door (see [Step 3](#)).

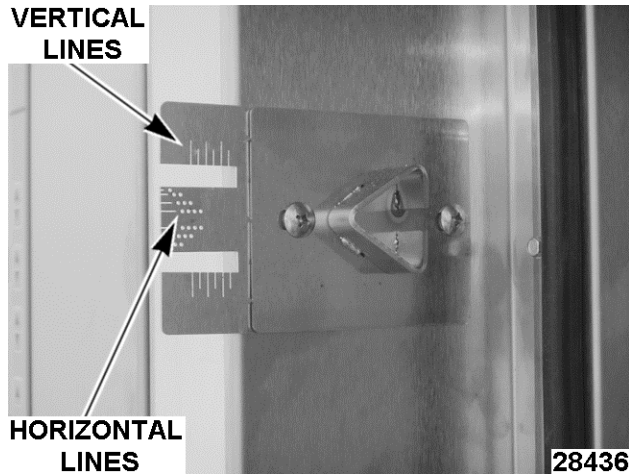

Fig. 86

B. Close the loading door to check roller alignment with latch ramp gauge. The hex hole should fit inside cutout on gauge as shown.

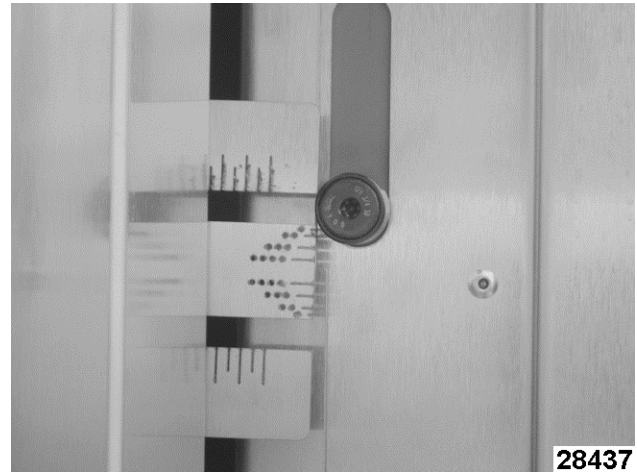

Fig. 87

C. If hex hole does not align with gauge, then the latch arms will have to be replaced.

NOTE: The horizontal line closest to bottom of hex hole will determine which latch arm to use. The horizontal lines and latch arms are identified with a different number of holes. The diagram below shows which linkage would need to be replaced. In this case you would use "00" linkages.



Fig. 88

3. To install latch arms:

A. Remove inner door handle cover ([Fig. 89](#)).

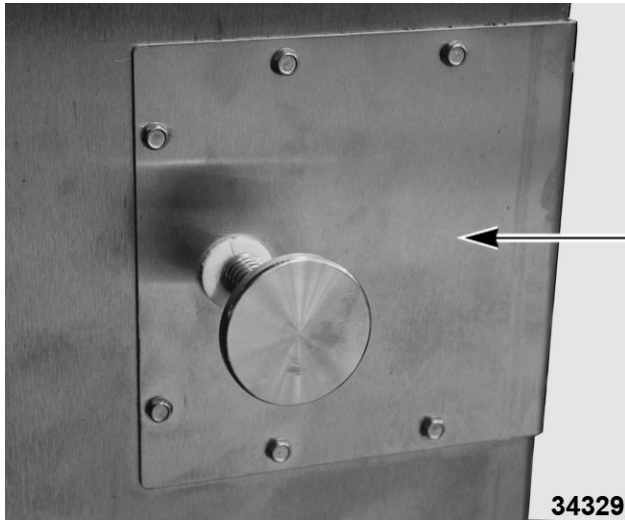

Fig. 89

NOTE: To prevent hardware from dropping into the inside of the door, cover the open space (5, Fig. 90) under latch arms.

- B. Remove 3/8" bolt (1, Fig. 90). DO NOT discard the tube, bolt, or washer.
- C. Remove E-clip and pin (2, Fig. 90). DO NOT discard the E-clip or Pin.
- D. Replace two latch arms (3, Fig. 90) with parts supplied. Reassemble inner mechanism, making sure linkage arms are located in the up position. Place unused arms in latch box and secure with 1/4-20 x 3/4" hex head serrated flange screw (6, Fig. 90). Reattach inner door handle.

NOTE: For left hand hinge, bolt and arms must be flipped and mounted to left-hand hinge hole (4, Fig. 90). Place unused arms in latch box and secure with 1/4-20 x 3/4" hex head serrated flange screw (6, Fig. 90).

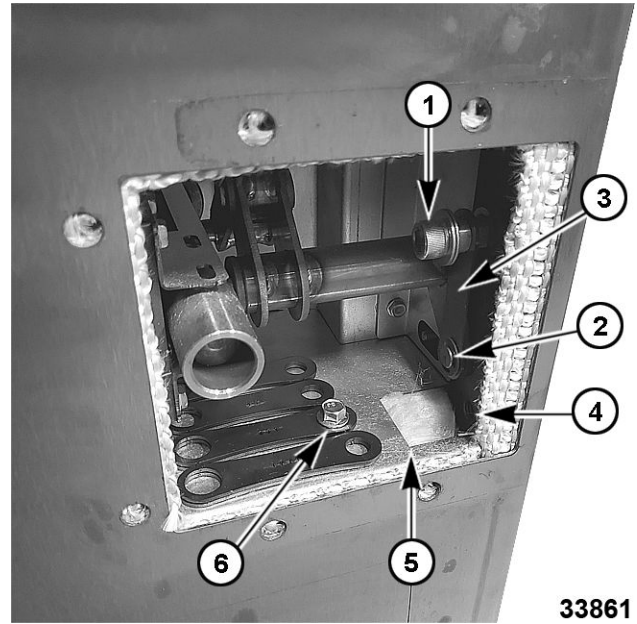

Fig. 90

- 4. To adjust door gasket seal:
 - A. Place a piece of paper at bottom hinge side between door and door gasket.
 - B. Close oven door and slowly pull the paper. There should be just enough resistance to keep paper from falling. Repeat this procedure around door every couple of feet. If door is too tight on hinge side, loosen the hinges on the door and adjust door outward, reverse if too loose. For latch side adjustment, loosen screws on ramp(s) and move ramp(s) in or out.
 - C. After adjusting the ramps for proper gasket seal, make sure rollers contact ramps at the same time. To check this, push the door closed until one roller lightly touches a ramp, check to see where door edge aligns with vertical lines on the ramp gauge. The door edge should align with the same vertical line on each ramp gauge.

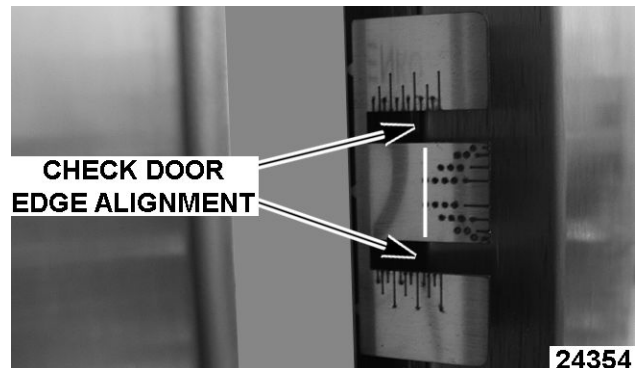

Fig. 91

- D. If adjustment is required, move a ramp so that both rollers contact the ramps at the same time.

NOTE: Keep in mind the door gasket seal. Both ramps need to be in correct location to equalize pressure on rollers.

- 5. Repeat the process until desired results are obtained or call Bakery Product Support.
- 6. After desired results obtained, bend alignment gauges back and forth to break off and discard.

NOTICE

DOOR MUST NOT SWING ON ITS OWN IN EITHER DIRECTION. IF IT DOES, THIS IS AN INDICATION THAT THE DOOR IS NOT HUNG LEVEL AND PLUMB. DOOR SWEEPS SHOULD NOT BE USED TO PREVENT DOOR FROM MOVING.

DOOR SWITCH ACTUATOR

- 1. Check door switch actuator for proper operation. See Fig. 93 and Fig. 94.

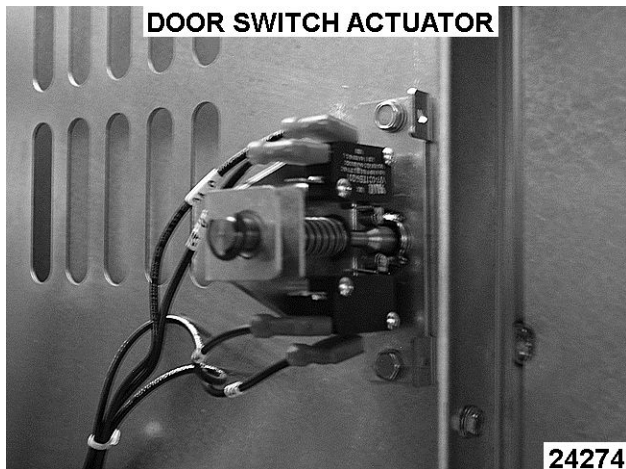
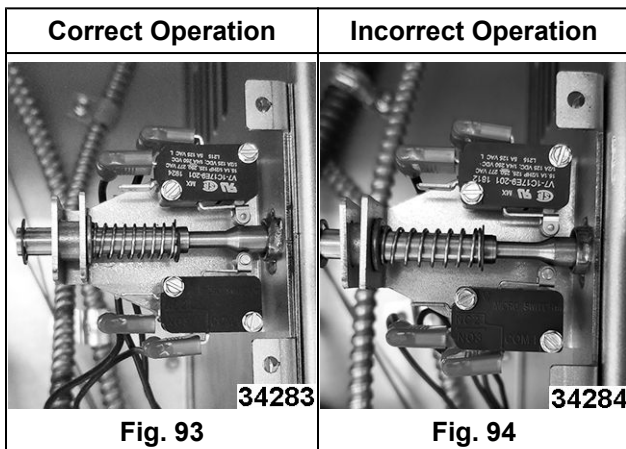

Fig. 92



DOOR SWEEP

- 1. Install door sweep.

NOTE: Door sweep shipped with door assembly.

- A. Adjust the door sweep so the metal door seal plate is 5/16" from the highest point on the floor.

NOTE: Door sweep has slots for adjustment.

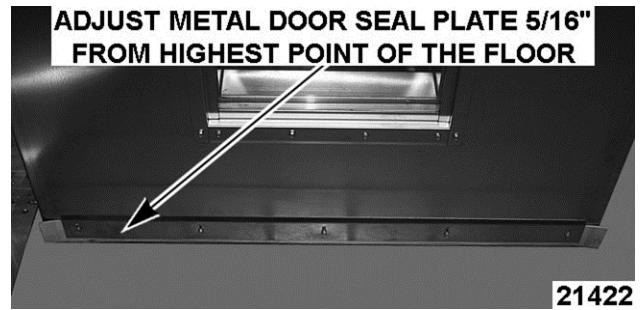
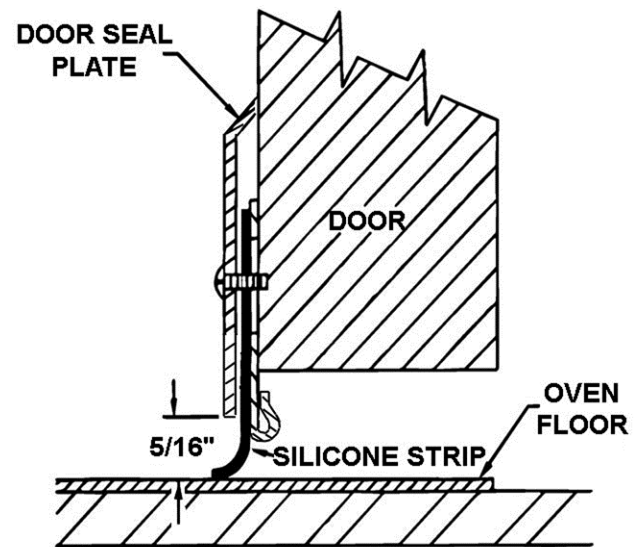

Fig. 95



21546

Fig. 96

SILICONE STRIP MUST MAINTAIN GAP WITH BUILDING FLOOR WHEN DOOR IS OPEN

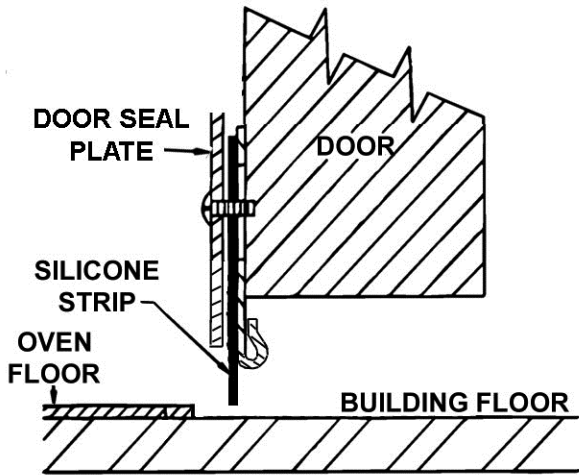

12126

Fig. 97

RACK CARRIERS

NOTE: After oven has been leveled.

1. Remove snap ring (B / C Lift) or pin and washer (A Lift) from rotation shaft and save for carrier installation. Cardboard tube can be discarded.
2. Place a level against rack shaft or carrier to verify both directions of the rack shaft and / or carrier are level. If adjustment is required, perform the following steps.
 - A. Loosen all four outer screws on the support plate, keeping them slightly snug.

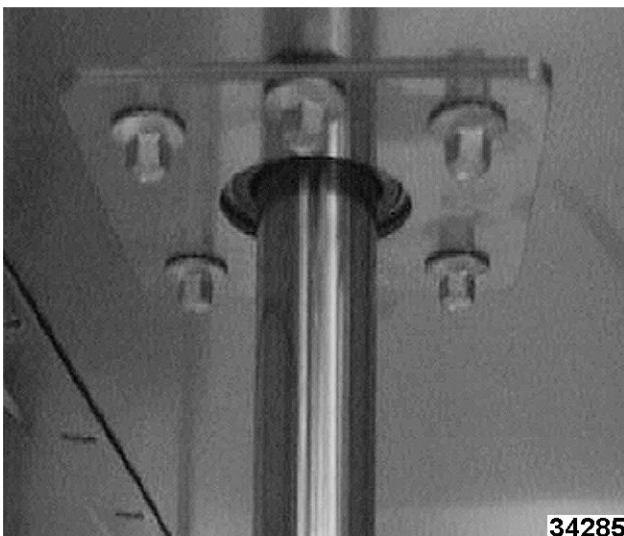

34285

Fig. 98

- B. Remove the center screw completely.
- C. Use a mallet to adjust the shaft level.

- D. After shaft is level, tighten the four corner screws to secure in place.
- E. A new hole will need to be drilled and tapped on the back side of the shaft support plate once the shaft is level. Use the hole in the support plate as a guide.

RACK CARRIER - A & C STYLE RACK LIFT

1. Prepare shaft for rack carrier installation.

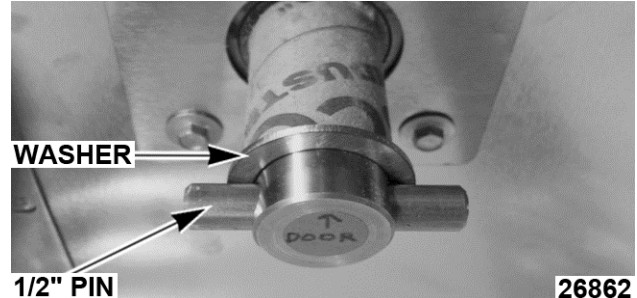

26862

Fig. 99

Installing "A" Lift

- A. Position the front of the carrier on shaft with arrows on the shaft and carrier aligned.
- B. Insert 1/2" pin through holes in carrier hub and shaft.

NOTE: If pin seems difficult to install, STOP and call Bakery Product Support. Pin should slide in with minimal effort.

NOTE: Pin should be centered and fit snugly in shaft.

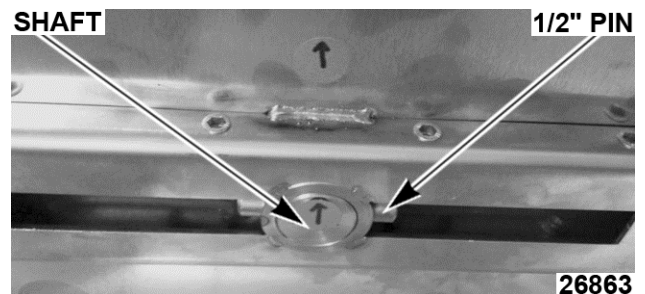

26863

Fig. 100

- C. Reinstall cover plate to the bottom of the carrier with screws provided.

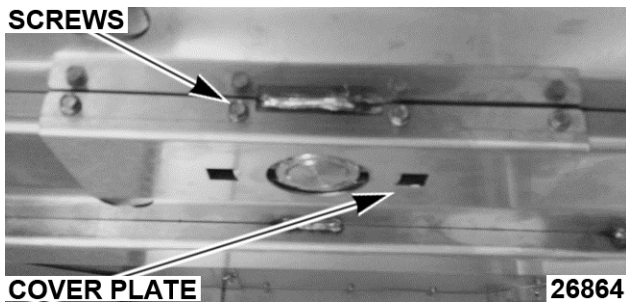

Fig. 101

Installing "C" Lift

- A. Apply food grade Never Seize to set screw threads on C Lift and start the set screws into the carrier.

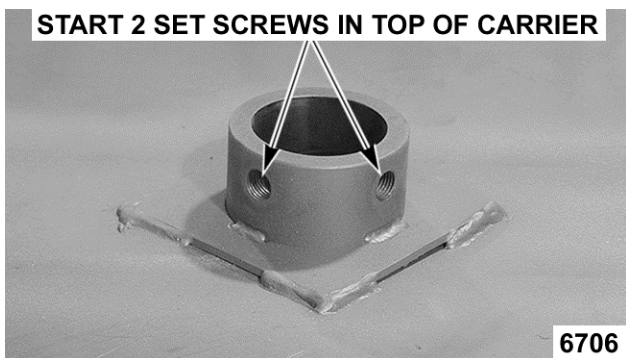

Fig. 102

- B. Slide the carrier onto the lift mechanism shaft and install the snap ring.

NOTE: Do Not allow the lift mechanism shaft to move upward. Hold shaft down from top of oven if necessary.

- 2. Roll baking rack onto carrier and check for proper carrier height.

NOTE: Carrier should be approximately 0.125" to 0.25" from rack lifting channels. Check multiple baking racks.

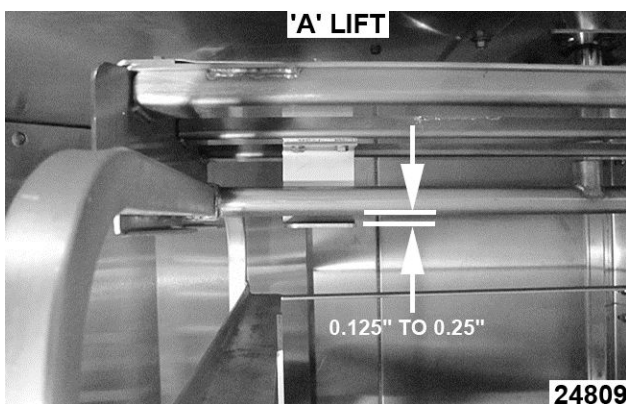

Fig. 103

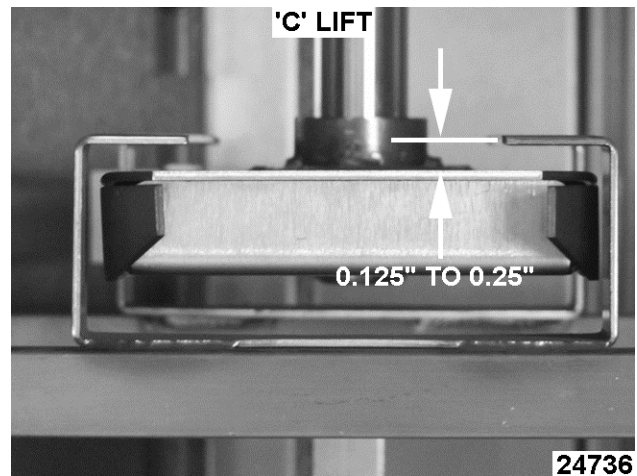

Fig. 104

- A. If carrier height needs adjusted, remove baking rack, and support carrier with oven rack and blocks of wood to correct height.



Fig. 105

- B. Access rotate/lift assembly at top of oven.
- C. Loosen rotate/lift shaft collar set screw 1/4 turn.

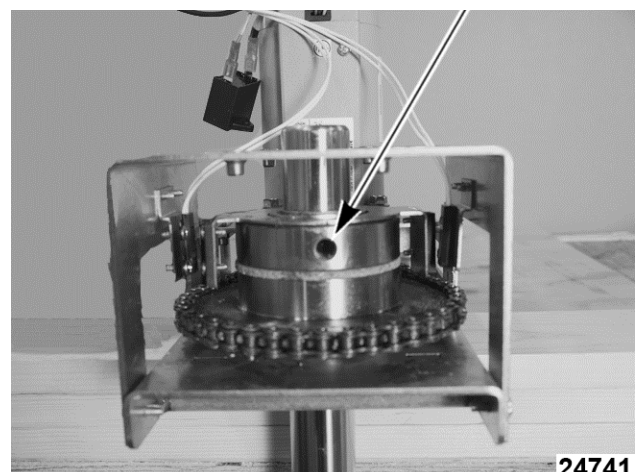

Fig. 106

- D. Remove screws securing Teflon bearing bracket to rotate/lift assembly and lift from assembly.

**REMOVE SCREWS
(5 PLACES)**



Fig. 107

- E. Factory installed shim washers 5 above and 5 below retaining ring. Position shim washers above or below the retaining ring for correct carrier height.

NOTE: Do not discard unused shims. Remaining shims should be kept with oven for future adjustment.



Fig. 108

- F. If carrier needs to be lower than snap ring will allow, access clevis pins on rear of lift and lower both equally.

NOTE: Always lower left and right clevis pins the same distance. One hole location equals 1/4" adjustment.

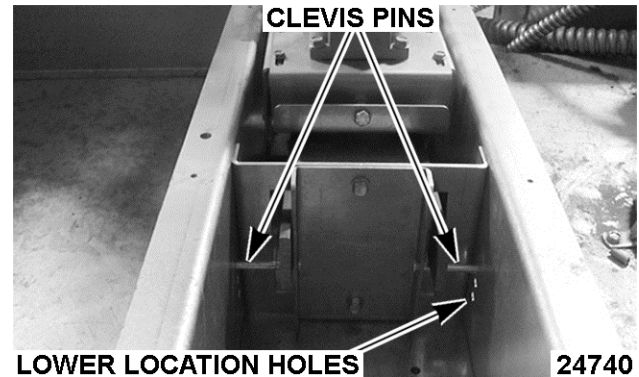

Fig. 109

3. Install snap ring, Teflon plate and tighten set screw.

NOTE: You might need to lift up on rotator body while tightening set screw to get shims flush with the snap ring.

NOTE: Check multiple racks.

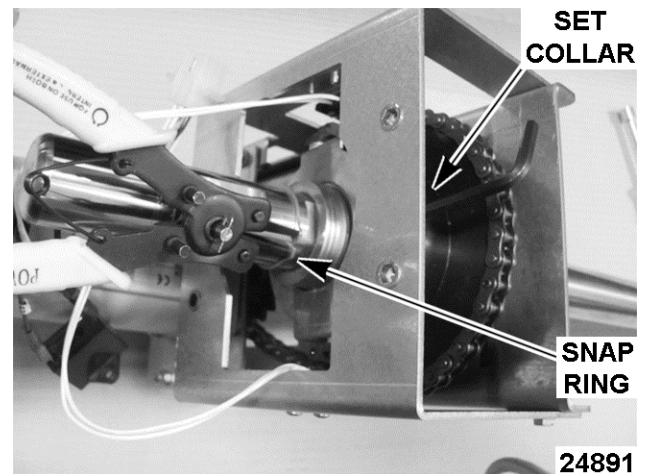

Fig. 110

RACK CARRIER - B STYLE RACK LIFT

NOTE: After oven is leveled.

1. Remove snap ring, shim washers, and cardboard shipping tube from lift shaft.

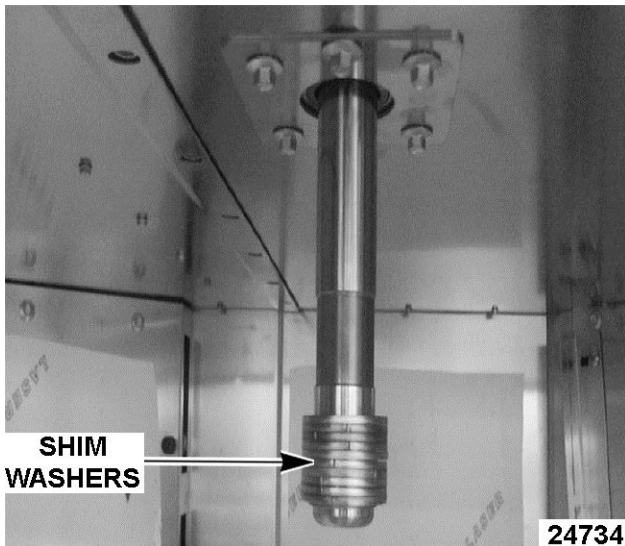

Fig. 111

2. Apply food grade Never Seize to set screw threads and start the set screws into the carrier.

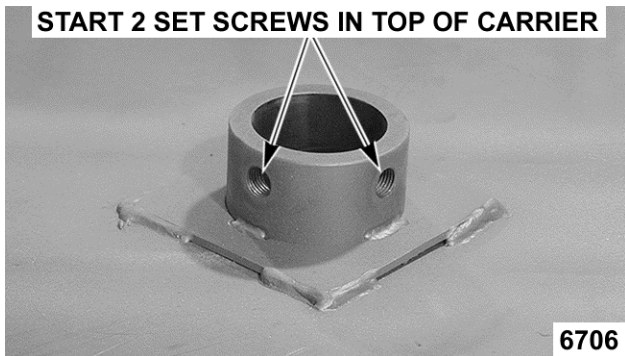

Fig. 112

3. Slide the carrier onto the lift mechanism shaft and install snap ring.
4. Roll baking rack onto carrier and check for proper carrier height.

NOTE: Carrier should be approximately 0.125" to 0.25" from rack lifting channels. Check multiple baking racks.

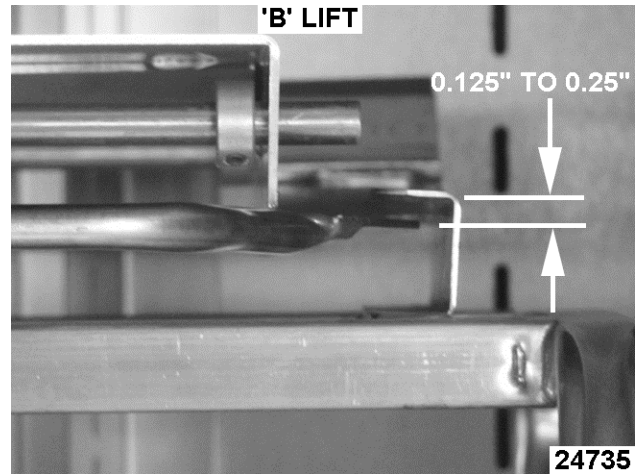

Fig. 113

- A. If carrier needs to be lowered more than snap ring will allow, access clevis pins in the rotate/lift assembly at top of oven and lower location to correct carrier height.

NOTE: Always lower left and right clevis pins the same distance. One hole location equals 1/4" adjustment.

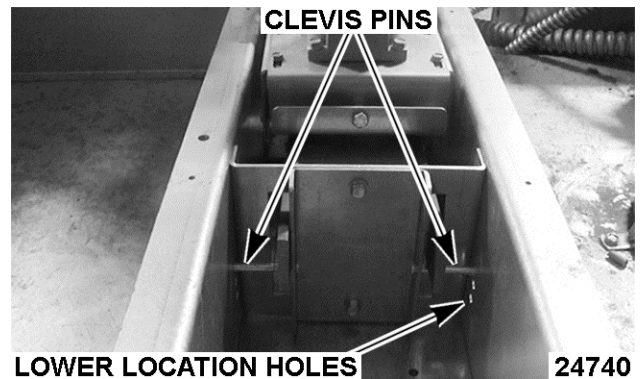

Fig. 114

5. If the carrier needs to be adjusted to get proper spacing, remove rack and add shims between snap ring and carrier as shown. Ten shims are provided with each oven.

NOTE: Check multiple racks

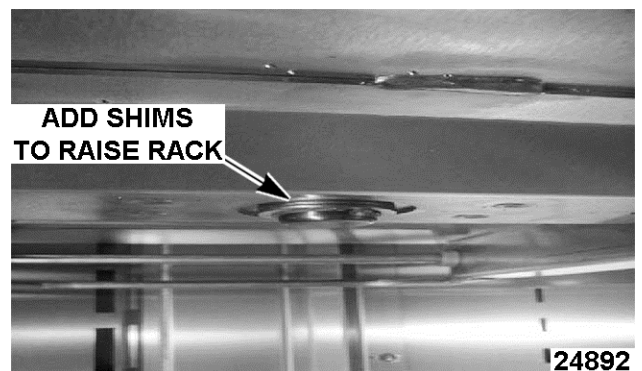

Fig. 115

6. Snug the set screws to hold the carrier in place.

NOTE: Do not discard unused shims. Remaining shims should be kept with oven for future adjustment.

VENT

1. Remove shipping ties from vent lid.

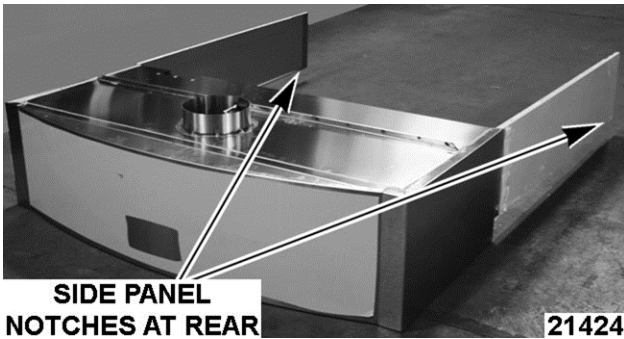

Fig. 116

HOOD ASSEMBLY

NOTE: After the hood is installed, the door assembly cannot be lifted off the hinge pins. The door hinges would have to be removed and installed from the door.

1. Set hood on the floor in front of oven. Remove only the necessary protective plastic from the hood.
 - A. Attach side panels with 10-32 screws 10 screw holes to the back of the hood, and ensure that the 3 screw holes are to the rear on each side panel. Align top of hood with the top edge of side trim panels before tightening the screws.



SIDE PANEL NOTCHES AT REAR

Fig. 117

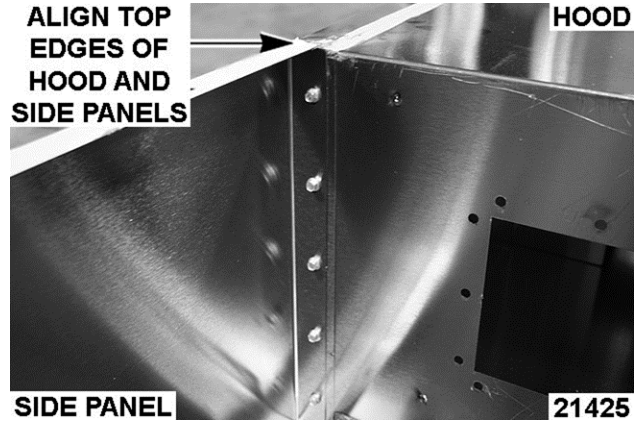

ALIGN TOP EDGES OF HOOD AND SIDE PANELS

HOOD

SIDE PANEL

21425

Fig. 118

- B. Attach rear panel to each side panel with 10-32 X 3/4" screws.

NOTE: If clearance is a problem, don't install the rear panel; set hood with side panels in place first.

- C. Install bracket between top of hood and hood side trim (2 places).

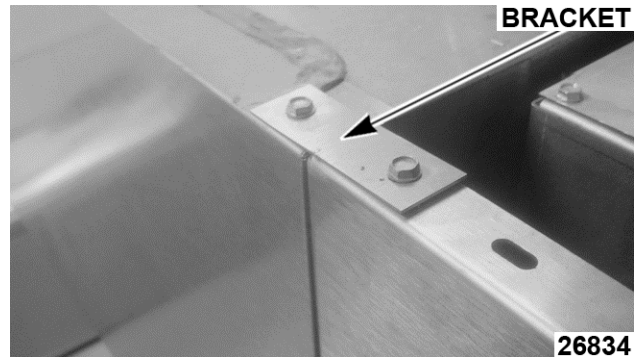

BRACKET

26834

Fig. 119

- D. Apply high temp red silicone around face of overpressure duct (Fig. 120).

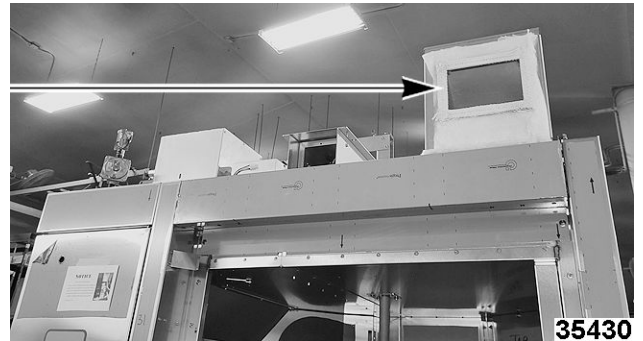

35430

Fig. 120

- E. Set hood in place on top of oven.

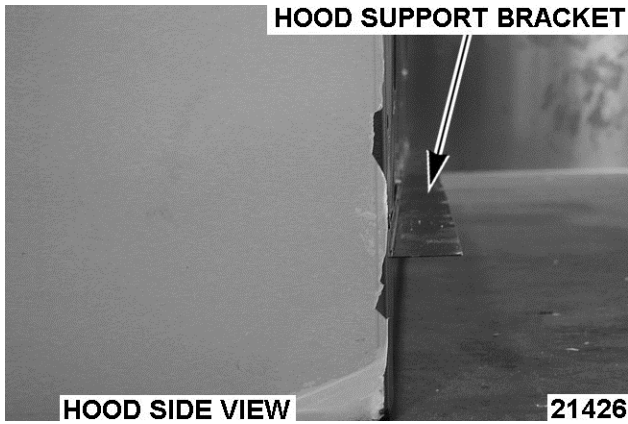

Fig. 121

- F. Ensure hood support bracket sets on front top edge of oven.
- G. Ensure bottom edge of hood is aligned with bottom edge of oven support (Fig. 122).



Fig. 122

- H. Secure side panels with #10 Tek screws into top of oven.
- I. If not attached in previous steps, attach rear panel of hood.
- J. Secure hood support bracket to top of oven with #10 Tek screws.



Fig. 123

- 2. Remove air baffle from hood.



Fig. 124

- 3. Connect the over pressure vent (right side of hood) using #10 Tek screws, in 8 places total.

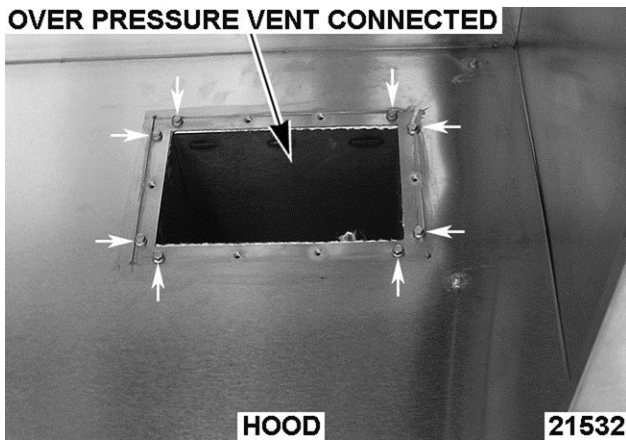

Fig. 125

4. Install over pressure damper to over pressure vent (right side of hood) using #10 Tek screws.



Fig. 126

5. Use gray NSF listed silicone to caulk header and seams at hood and side panels (see Fig. 127), as well as bottom edge seam of hood along oven front (see Fig. 128).



Fig. 127



Fig. 128

6. Customer is responsible for having a flue pipe connected to the center hood connection. See appropriate oven specification.

HOOD VENTING

1. Install exhaust connection plate (1, Fig. 129) to hood assembly (2, Fig. 129).

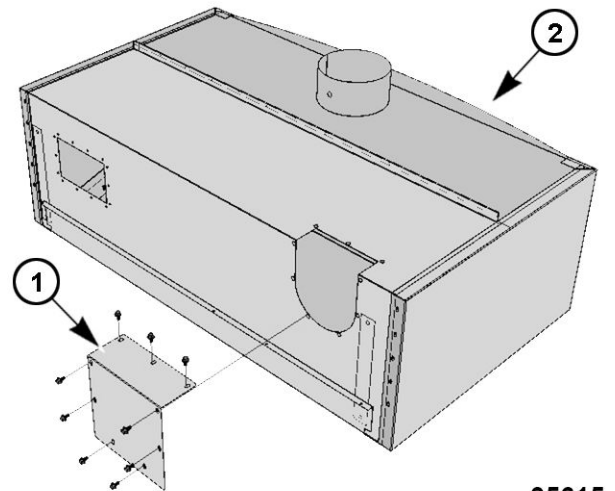

Fig. 129

35615

View from Under Hood

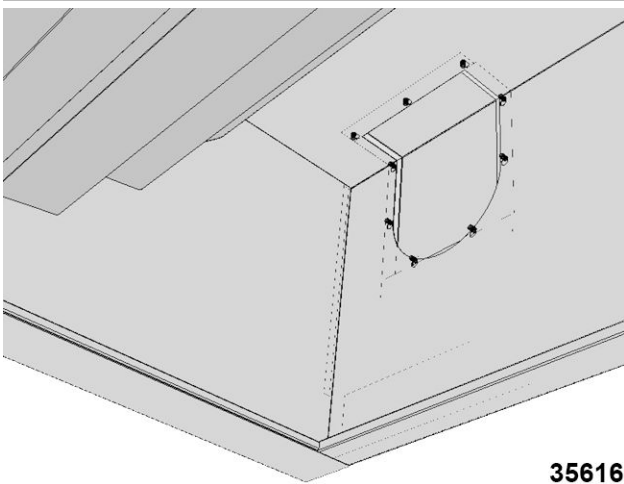

Fig. 130

35616

- Secure connection plate to hood with 1/4-20 x 1/2 screws.

AIR Baffle & GREASE FILTERS

- Install air baffle (1, [Fig. 131](#)) with 1/4-20 acorn nuts.
- Install grease filters (2, [Fig. 131](#)) for type 1 hood or install louvered plenum panel ([Fig. 133](#)) for type 2 hood.

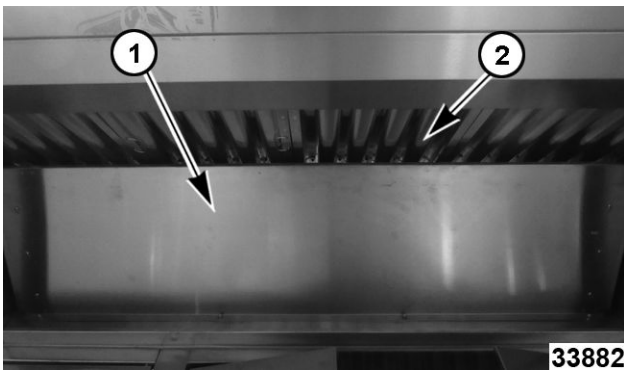

Fig. 131

33882



Fig. 132

28513



Fig. 133

34289

CAULK OVEN

- Caulk around oven with gray NSF listed silicone.

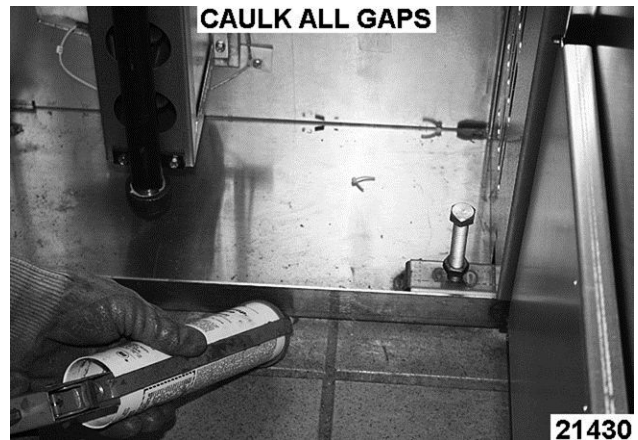

Fig. 134

21430

INITIAL STARTUP



WARNING

Certain procedures in this section require electrical test or measurements while power is applied to the machine. Exercise extreme caution at all times and follow Arc Flash procedures. If test points are not easily accessible, disconnect power and follow Lockout/Tagout procedures, attach test equipment and reapply power to test.

NOTE: Remove all protective plastic sheeting from oven surfaces and wipe down to remove all fingerprints, prior to heating oven.

NOTE: All utility connections by others.

Power and Plumbing Connections

- Verify the following:
 - Gas supply line shut-off valve is in the OFF position.
 - Gas supplied matches data plate and gas valve on oven.
 - Oven gas valve is in the OFF position.
 - Electrical connections have been made by electrician. 120V control, high voltage, and powered roof ventilator (external device).

NOTE: Refer to the service entrance label on the oven for electrical connections.

- Turn the 120V supply power ON.
- Turn the circuit breakers ON.
- Drain connected (with air gap) by plumber and opposite end of drain plugged.
- Water line is connected by plumber to flow restrictor located on top left rear corner of oven.
- Water shut off is installed in supply line.

NOTE: If a water filtration unit is installed in supply line, verify that a filter cartridge is installed in unit (performed by customer).

NOTE: Complete oven Installation Checklist and complete Startup Checklist during initial start-up.

Start Up

1. Close oven door.

2. Turn oven power ON. Use DOWN arrow key to input lowest bake temperature so oven will not initiate a call for heat.
3. Verify operation of roof mounted ventilator.

NOTE: Verify plenum panel or grease filters installed.

- A. Attach 1/8" NPT to hood collar, use 1/4" alum line to attach manometer or equivalent.

4. Verify air louvers are set at factory settings.

NOTE: Factory louver settings located inside of control compartment door, along with louver gauges.

5. Verify that rack carrier height will accept racks when loading, and that rack casters do not drag when rack is in the raised position.

NOTE: Racks expand when hot. There should be approximately 1/2" clearance from bottom of carrier to top of rack. Check all racks to verify rack acceptance into carrier. Check rack heights of all racks in bakery. Verify that all heights are within 1/4" of each other.

6. Verify that rack is level and rotating properly when door is closed; and rack stops in the correct loading position when door is opened - with and without rack loaded onto carrier.
7. For 3-phase option, verify that baking compartment circulation blower is turning in direction indicated on motor. If not, disconnect power and switch any two of the three phase lead wires.
8. Verify steam system operation.
 - A. Set oven control to have 1 plus minutes on bake timer display.
 - B. Set steam time for 20 seconds.
 - C. Press START key to begin timer countdown.
 - 1) Water solenoid should energize.
 - D. Press STOP key to silence beeper.
9. Initial heating of oven.
 - A. Leave loading door ajar approximately 2" to evacuate smoke and prevent tarnishing of oven interior, but not open far enough to prevent operation of oven.
 - B. Set the oven to bake for 30 minutes at 300°F (150°C) with vent open.
 - C. After time elapses, press STOP to silence beeper.
 - D. Fully open loading door to verify that baking compartment circulation blower de-energizes.

- E. Set the oven to bake for 30 minutes at 400°F (200°C) with vent open.
 - F. After time elapses, silence the beeper and allow oven to heat for an additional 30 minutes with loading door closed.
10. Steam test.
- A. With oven temperature at 450°F (230°C) set a recipe for 20 seconds of steam and 1 minute of bake time, then press START to initiate steam test.
 - B. Check for steam leakage around and under loading door. If leakage is present, adjust door and/or door sweep as required.
 - C. After time has expired press STOP to silence beeper.
11. Cool Down.
- A. Set oven temperature to 50°F (10°C).
 - B. Set oven to cool down.
 - C. After oven has reached a safe cool down temperature, stop automatic cool down and/or turn the oven power OFF.

FINAL CHECKS

- 1. Complete Startup Checklist.
- 2. Record start-up information on the label provided inside the control compartment door.

NOTE: Oven warranty will not be granted unless Startup Checklist has been completed and received by Hobart/Baxter.

RACK OVEN-HARDWARE IDENTIFIER

Photo	Part Number	Description	Photo	Part Number	Description
	01-1000V0-00080	BEARING, BRASS - DOOR HINGE		01-1000V4-00480	1/4-20 X 1.00 INCH LONG FLAT HEAD SCREW
	01-1000V0-00091	E-CLIP LOCK BAR (NOT INCLUDED IN HARDWARE KIT)		01-1000V4-00481	1/4-20 X .75 INCH LONG FLAT HEAD SCREW
	01-1000V4-00058	5/16-18 X 1 INCH LONG, GIMLET SCREW		01-1000V4-00482	1/4-20 X .50 INCH LONG FLAT HEAD SCREW
	01-1000V4-00069	1/2-13 NUT		01-1000V4-00498	1/4-20 X .75 INCH LONG, PAN HEAD SCREW
	01-1000V4-00073	1/4-20 ANCHOR (MILD STEEL)		01-1000V4-00499	1/4-20 X .75 INCH LONG, FLAT HEAD SCREW
	01-1000V4-00161	3/8-16 SET SCREW (CARRIER)		01-1000V4-00503	PIVOT SCREW (1/4-20) (NOT INCLUDED IN HARDWARE KIT)
	01-1000V4-00199	3/8-24 SET SCREW (ROTATION)		01-1000V4-00531	3/8-16 LOCK BAR SCREW, (NOT INCLUDED IN HARDWARE KIT)
	01-1000V4-00264	1/2" LOCK WASHER		01-1000V4-00542	#8 PHIPS (ROTATION CAPACITOR)
	01-1000V4-00283	1/4-20 X .75 INCH LONG, HEX HEAD WIDE SERRATED FLANGE SCREW		01-100V18-00078	#7 DRILL BIT (1/4-20 TAP)
	01-1000V4-00284	10-32 X .75 INCH LONG SCREWS		01-100V18-0128E	#20 DRILL BIT (10-32 TAP)
	01-1000V4-00364	3/8-16 LOCK BAR WASHER (NOT INCLUDED IN HARDWARE KIT)		01-100V18-0129A	10-32 TAP
	01-1000V4-00385	# 10 TEK SCREW		01-100V18-0129D	1/4-20 TAP
	01-1000V4-00387	1/4-20 X 0.50 INCH SCREW		01-1M2372-00001	CENTER FLOOR WASHER
	01-1000V4-00400	10-32 X .75 INCH LONG, GIMLET POINT SCREW		01-1M6101-00114	TUBE LOCK BAR, (NOT INCLUDED IN HARDWARE KIT)
	01-1000V4-00465	1/2-13 X 1-1/2 INCH LONG BOLT		01-1M6101-00115	DOOR HANDLE PIVOT PIN, (NOT INCLUDED IN HARDWARE KIT)
	01-1000V4-00479	1/4-20 X .75 INCH LONG, HEX HEAD THREAD CUTTING SCREW		01-1M6108-00110	ARM LOCK BAR PIVOT, (NOT INCLUDED IN HARDWARE KIT)