



**FKM-TC**  
**ELECTRIC PRESSURE FRYER WITH TRAINING CENTRAL™**  
**OPERATOR & INSTALLATION MANUAL**

**BKI**

[www.bkideas.com](http://www.bkideas.com)

42 Allen Martin Drive, Essex Junction, Vermont 05452 USA Telephone: (802) 658-6600 Fax: (802)864-0183

PN SS-OM- 059.05 (8/20/21)

© 2021 - BKI

# BKI LIMITED WARRANTY

42 Allen Martin Drive, Essex Junction, VT 05452 • USA  
(802) 658-6600 • Fax: (802) 864-0183

---

<b>WHAT IS COVERED</b>	<p>This warranty covers defects in material and workmanship under normal use, and applies only to the original purchaser providing that:</p> <ul style="list-style-type: none"><li>• The equipment has not been accidentally or intentionally damaged, altered or misused;</li><li>• The equipment is properly installed, adjusted, operated and maintained in accordance with national and local codes, and in accordance with the installation and operating instructions provided with this product.</li><li>• The serial number rating plate affixed to the equipment has not been defaced or removed.</li></ul>
<b>WHO IS COVERED</b>	<p>This warranty is extended to the original purchaser and applies only to equipment purchased for use in the U.S.A.</p>
<b>COVERAGE PERIOD</b>	<ul style="list-style-type: none"><li>• Warranty claims must be received in writing by BKI within one (1) year from date of installation or within one (1) year and three (3) months from data of shipment from the factory, whichever comes first.</li><li>• Warranty period begins the date of dealer invoice to customer or ninety (90) days after shipment date from BKI, whichever comes first.</li></ul>
<b>WARRANTY COVERAGE</b>	<p>This warranty covers on-site labor, parts and reasonable travel time and travel expenses of the authorized service representative up to (100) miles round trip and (2) hours travel time and performed during regular, weekday business hours.</p>
<b>EXCEPTIONS</b>	<p>Any exceptions must be pre-approved in advance and in writing by BKI. The extended door warranty on convection ovens years 3 through 5 is a parts only warranty and does not include labor, travel, mileage or any other charges.</p>
<b>EXCLUSIONS</b>	<ul style="list-style-type: none"><li>• Negligence or acts of God,</li><li>• Thermostat calibrations after (30) days from equipment installation date,</li><li>• Air and gas adjustments,</li><li>• Light bulbs,</li><li>• Glass doors and door adjustments,</li><li>• Fuses,</li><li>• Adjustments to burner flames and cleaning of pilot burners,</li><li>• Tightening of screws or fasteners,</li><li>• Failures caused by erratic voltages or gas suppliers,</li><li>• Unauthorized repair by anyone other than a BKI Factory Authorized Service</li><li>• Damage in shipment,</li><li>• Alteration, misuse or improper installation,</li><li>• Thermostats and safety valves with broken capillary tubes,</li><li>• Freight – other than normal UPS charges,</li><li>• Ordinary wear and tear,</li><li>• Failure to follow installation and/or operating instructions,</li><li>• Events beyond control of the company.</li></ul>
<b>INSTALLATION</b>	<p>Leveling, as well as proper installation and check out of all new equipment - per appropriate installation and use materials – is the responsibility of the dealer or installer, not the manufacturer.</p>
<b>REPLACEMENT PARTS</b>	<p>BKI genuine Factory OEM parts receive a (90) day materials warranty effective from the date of installation by a BKI Factory Authorized Service Center.</p> <p>Warranty is in lieu of all other warranties, expressed or implied, and all other obligations or liabilities on the manufacturer's part. BKI shall in no event be liable for any special, indirect or consequential damages, or in any event for damages in excess of the purchase price of the unit. The repair or replacement of proven defective parts shall constitute a fulfillment of all obligations under the terms of this warranty.</p>

---

# TABLE OF CONTENTS

## INTRODUCTION

Safety Precautions .....	2
Safety Signs and Messages .....	2
Specific Precautions .....	3
Safe Work Practices .....	4
Safety Labels .....	8

## INSTALLATION

Unpacking and Handling .....	10
Installation Procedure .....	10
Wiring .....	11
Initial Test and Adjustment .....	12
Care of Shortening .....	13

## OPERATION

Start-Up (FKM-TC with Training Central™) .....	14
Cooking (FKM-TC with Training Central™) .....	17
Product Programming .....	20
Set Oil Temp .....	24
Set Clock .....	25
Settings .....	26
Frying Log .....	27
Machine Log .....	28
Import/Export .....	29
Change Code .....	32
Touchscreen .....	33

## MAINTENANCE

Scheduled Maintenance .....	34
Safety Pop Valve Procedure .....	35
Filtering Procedure .....	36
Basic Filter .....	38
Filter with Rinse Hose .....	43
Boil Out .....	48
Filter Pad Replacement .....	52
Troubleshooting .....	55
Filter Pump Reset .....	56

## INTRODUCTION

The FKM-TC series fryer with Training Central™ is compact, attractive and functional in design. The built in Training Central™ program allow employees to manage virtually every operation—programming, cooking, cleaning, filtering, boiling out, and more—simply by following intuitive, step-by-step screen instructions that provide instant feedback. FKM fryers are constructed with a stainless steel fryer pot for easy cleaning. Exclusive BKI patented features and safety devices offer flexibility, efficiency and reliability plus **PERFECTION IN PRESSURE FRYING!**

The BKI name and trademark on this unit assures you of the finest in design and engineering -- that it has been built with care and dedication -- using the best materials available. Attention to the operating instructions regarding proper installation, operation, and maintenance will result in long lasting dependability to insure the highest profitable return on your investment.

### NOTICE

PLEASE READ THIS ENTIRE MANUAL BEFORE OPERATING THE UNIT. If you have any questions, please contact your BKI Distributor. If they are unable to answer your questions, contact the BKI Technical Service Department, (802) 658-6600.

### SAFETY PRECAUTIONS

Always follow recommended safety precautions listed in this manual. Below is the safety alert symbol. When you see this symbol on your equipment, be alert to the potential for personal injury or property damage.



### Safety Signs and Messages

The following Safety signs and messages are placed in this manual to provide instructions and identify specific areas where potential hazards exist and special precautions should be taken. Know and understand the meaning of these instructions, signs, and messages. Damage to the equipment, death or serious injury to you or other persons may result if these messages are not followed.



This message indicates an imminently hazardous situation which, if not avoided, will result in death or serious injury.



This message indicates a potentially hazardous situation, which, if not avoided, could result in death or serious injury.



This message indicates a potentially hazardous situation, which, if not avoided, may result in minor or moderate injury. It may also be used to alert against unsafe practices.



This message is used when special information, instructions or identification are required relating to procedures, equipment, tools, capacities and other special data.

## Specific Precautions



Risk of fire exists if the oil level drops below the minimum indicated level.



Use of oil/shortening older than the manufacturers recommendations for life of the oil is prone to surge boiling and flash fires. Follow the oil manufacturers guidelines for the life cycle of oil/shortening.



Do not open the drain valve or the fill valve while the fryer is operating. Serious burns may result.



Improper installation, adjustment, alteration, service or maintenance can cause property damage, injury or death. Read the installation, operation and maintenance instructions thoroughly before installing or servicing this equipment.



### California Residents Only

This product can expose you to chemicals including chromium, and lead which are known to the State of California to cause cancer and birth defects or other reproductive harm. For more information go to [www.P65Warnings.ca.gov](http://www.P65Warnings.ca.gov).



Follow instructions regarding effects of surge boiling of over-wet foods and proper load size.



### Equipotential ground plane

When a high current flows through a conductor, differences in potential appear between the conductor and nearby metallic surfaces near the appliance. As a result, sparks may be produced between the appliance and surrounding metal surfaces. These sparks could cause serious injury, damage, or fire.



BKI provides an Equipotential ground terminal for the connection of a bonding conductor after the installation of the appliance per IEC60417-1. This terminal is located on the inside of the Power Entry Supply box near the Earth connection and is marked with this symbol.



This appliance is intended for commercial/professional use only and should be operated by fully trained and qualified personnel. It is not intended for continuous mass production of food.



If the power supply cord is damaged, it must be replaced by a BKI Authorized Service and Parts (ASAP) company technician, or a similarly qualified person in order to avoid a hazard. In Europe, supply cords must be oil resistant, sheathed flexible cable not lighter than ordinary polychloroprene or other equivalent synthetic elastomer-sheathed cord (Code designation 60245 IEC 57).



Solid shortening must not be used, or clogged pump lines, and pump damage are possible.



A country approved all pole circuit breaker with a minimum open contact gap of 3mm must be used for proper installation. (CE countries)



### Full Disconnection

In accordance with Local and/or National wiring codes, the installer must provide a means of full disconnection under over voltage Category III conditions. An IEC approved cord and plug combination will meet this requirement.

Units not provided with a cord and plug do not meet this requirement. In accordance with Local and/or National wiring codes, the installer must provide the means of full disconnection.



The fryer is designed to hold a maximum of 75lbs (34KG) of oil/shortening.

## Safe Work Practices

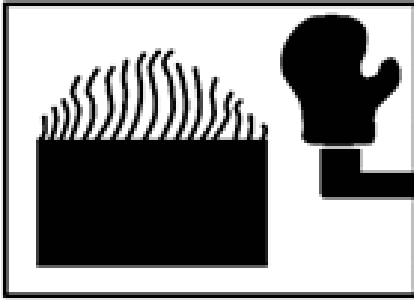

### Wear Safe Clothing Appropriate To Your Job

Always wear your insulated mitts when handling the fryer basket or touch any hot metal surfaces. You received a pair of insulated mitts with your fryer. If you lose or damage your mitts, you can buy new ones at your local restaurant equipment supply store or from your local BKI Distributor.

Always wear non-skid shoes when working around the fryer or any other equipment that uses shortening. Never wear loose clothing such as neckties or scarves while operating your fryer. Keep loose hair tied back or in a hair net while operating your fryer.

Always wear appropriate personal protection equipment during the filtering process to guard against possible injury from hot oil.

Always wear appropriate personal protection equipment during the boil-out process to guard against possible injury from hot cleaning solution.

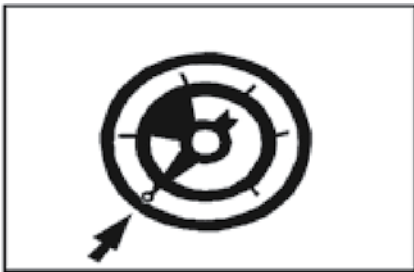

### Never Loosen The Spin Handle Until The Pressure Gauge Is At Zero

Steam may escape suddenly if you loosen the spin handle before the gauge is at zero. If steam escapes suddenly, you could be burned.

After the pressure gauge is at zero, wait 5 seconds. Then loosen the spin handle slowly to open the lid of the fryer. By doing this, the steam will escape slowly and there is less change of being burned. Always use extreme caution when working around the fryer with the lid open.

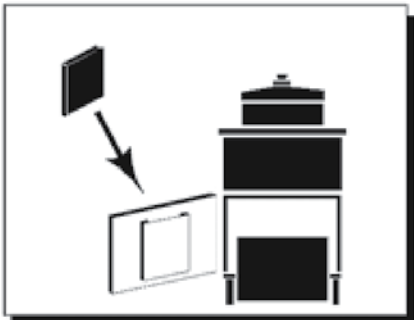

### Keep this manual with the Equipment

This manual is an important part of your equipment. Always keep it near for easy access.

If you need to replace this manual, contact:

#### **BKI**

Technical Services Department

42 Allen Martin Drive

Essex Junction, VT 05452

(802) 658-6600



### Protect Children

Keep children away from this equipment. Children may not understand that this equipment is dangerous for them and others.

NEVER allow children to play near or operate your equipment.

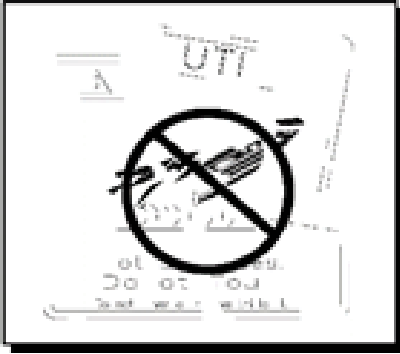

### Keep Safety Labels Clean and in Good Condition

Do not remove or cover any safety labels on your equipment. Keep all safety labels clean and in good condition. Replace any damaged or missing safety labels. Refer to the Safety Labels section for illustration and location of safety labels on this unit.

If you need a new safety label, obtain the number of the specific label illustrated on page 8, then contact:

#### BKI

Technical Services Department  
42 Allen Martin Drive  
Essex Junction, VT 05452  
(802) 658-6600

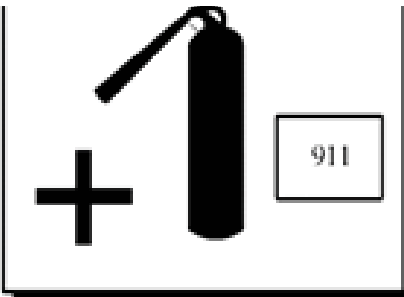

### Be Prepared for Emergencies

Be prepared for fires, injuries, or other emergencies.

Keep a first aid kit and a fire extinguisher near the equipment. You must use a 40-pound Type BC fire extinguisher and keep it within 25 feet of your equipment.

Keep emergency numbers for doctors, ambulance services, hospitals, and the fire department near your telephone.

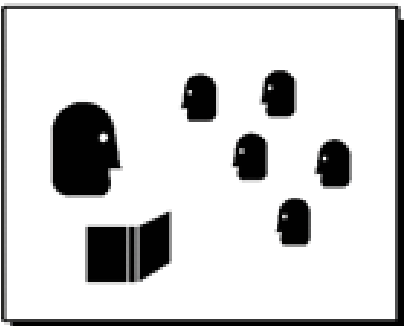

### Know your responsibilities as an Employer

- Make certain your employees know how to operate the equipment.
- Make certain your employees are aware of the safety precautions on the equipment and in this manual.
- Make certain that you have thoroughly trained your employees about operating the equipment safely.
- Make certain the equipment is in proper working condition. If you make unauthorized modifications to the equipment, you will reduce the function and safety of the equipment.



### Noncombustible Floors Only

Make sure your floor is noncombustible. Do not operate your fryer on floors that are wood, carpeted or have rubber mats.

- Placing your fryer on a combustible floor could cause a fire. Serious injury could result.
- Examples of noncombustible floors where you can safely place your fryer are concrete, tile, and ceramic.



### Keep The Area Around Your Fryer Uncluttered

Make sure to keep the area around your fryer clear of any obstacles.

Serious injury can occur if you trip or fall near the fryer. You could be burned by hot shortening that splashes out of the fryer or by falling against the hot metal of the fryer.



### Keep The Floor Around Your Fryer Clean Of Shortening

Make sure to keep the floor around your fryer clean of shortening and other liquids.

Serious injury can occur if you slip near your fryer. You could be burned by hot shortening that splashes out of the fryer or by falling against the hot metal of the fryer.



### Keep The Lid Closed When The Fryer Is Not In Use

Hot shortening can splash if someone moves the fryer or bumps into it. Serious injury can occur if hot shortening splashes out of the fryer.

Do not lean, sit or stand on the fryer or perform any maintenance or cleaning duties while the fryer or the shortening is hot. You could be burned.



### Keep The Casters Locked

To avoid spilling shortening, keep the casters locked. If any shortening spills near your fryer, clean it up immediately.

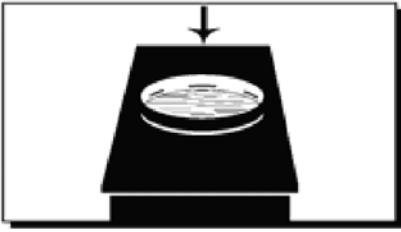

### Do Not Overfill The Fryer With Shortening

Hot shortening and steam may escape and burn you if you put too much shortening in the fryer. Fill the fryer to approximately one inch below the fill marks that are inside the fryer pot. Heat the shortening. If needed, carefully add more shortening to bring the level to the fill marks.



### Do Not Let Any Water Get Into The Fryer

Always remove excess moisture from food before placing it into the fryer basket. Water will cause the hot shortening to spatter. You could be burned.



### Do Not Overload The Basket With Food

Hot shortening and steam may escape and burn you if you place too much food in the basket.



### Always Make Sure The Lid Hook Is Latched When Closing The Fryer

To make sure the lid hook is latched properly, press down the lid until the hook snaps shut. Hot shortening and steam can escape if the lid hook is not latched properly. You could be burned.



### Keep Away From The Vent

Hot steam escapes from the vent continuously when you are using your fryer. You could be burned if you get too close to the vent.

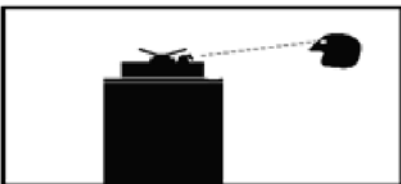

### Seal The Safety Valve Properly

To seal the safety valve, lift the arm on the side of the valve. Then release it. The valve should snap closed. Hot steam can escape from the valve and you could be burned if you do not seal the valve properly.

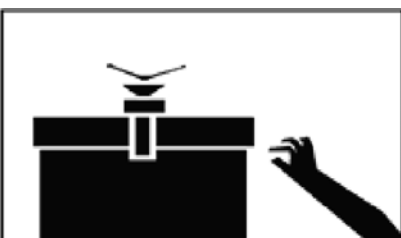

### Always Tighten The Spin Handle When Closing The Fryer

Hot shortening and steam can escape if you do not tighten the spin handle properly. You could be burned. Line up the orange knobs on the fryer lid handle and the front hook when tightening.

### Do Not Over-Tighten The Spin Handle

You could damage the fryer.

Safety Labels

N0153

**WARNING**



**ACME SCREW AND NUT**

1. Check for wear and excessive looseness.
2. Screw should be oiled every 30 days.
3. **IMPORTANT:** At least every six months remove screw and nut to inspect for excessive wear in threads; or, if at any time a sign of wear appears, replace at once to insure maximum efficiency and safety of operation.
4. Do not over-tighten spindle assembly (only tighten to hold pressure).
5. For service, contact your local BKI Distributor, or BKI P.O. Box 85400 Simpsonville, SC 29680-0400 Phone: 1-864-963-3471

Do not cover or remove this label. N0153

N0160

**WARNING**



Before using this machine, carefully read, understand, and obey

- \* All warnings on this machine
- \* The instruction manual inside the door.

Failure to do so can result in serious injury.

If your manual or the labels on this machine become unreadable or lost, or if you need other assistance, call or write BKI, 1-864-963-3471

Do not cover or remove this label. N0160

N0162

**CAUTION**



**Hot surfaces. Do not touch.**

Do not cover or remove this label. N0162

N0164

**WARNING**



**HOT STEAM. Keep away from Vent and Safety Valve. Failure to do so could result in serious burns.**

Do not cover or remove this label. N0164

N0345

**SAFETY INSTRUCTIONS**



Read Instruction Manual before operating unit.

1. Fill fry pot with oil to Fill Mark. Do not overfill. Hot oil and steam may overflow.
2. Do not allow any water to enter fryer unit. Always remove excess moisture from food before frying.
3. Always use insulated mitts when handling basket.
4. Handle must be securely attached to basket (applies only to detachable handle). Do not overload basket.
5. Handle must be securely latched to pot before tightening spindle. After spindle is tight, orange knob must line up with orange knob on back. Do not over-tighten.
6. Never loosen spindle until pressure gauge reads zero, then wait 5 seconds. Open spindle slowly to prevent dangerous or unexpected steam release.
7. Always keep lid closed when frying. Filtering with semi-automatic fill system, hot using fryer unit.
8. Always turn off fryer unit when not in use.

Do not cover or remove this label. N0345

N0176

**DANGER**



**INSTRUCTION AND SAFETY MANUAL**

Before operating this fryer, study the manual located in this pocket. Understand all safety and warning instructions.

If you have any questions on the operation of this fryer, contact BKI 1-864-963-3471 or your authorized service agent.

Failure to follow these instructions can result in severe personal injury or death.

Return the manual to this pocket.

Do not cover or remove this label. N0176

N0175

**CAUTION**



**Slipping/tripping can result in serious injury. DO NOT drip oil on floor. Keep area clean and dry. ALWAYS lock wheels to prevent spillage of hot oil.**

Do not cover or remove this label. N0175

N0527

**SAFETY INSTRUCTIONS**



Read Instruction Manual before operating unit to avoid possibility of serious injury.

1. Do not smoke anywhere near fryer.
2. Fill fry pot with oil to Oil Level mark. Do not overfill. Hot oil may overflow.
3. ALWAYS remove excess moisture from food before frying.
4. Handle must be securely attached to basket (applies only to detachable handle).
5. DO NOT OVERLOAD BASKETS. ALWAYS use insulated mitts when handling baskets.
6. ALWAYS hold filler hose down over pot to fill oil fill from hose.
7. Fill valve must be in proper position and hose disconnected before frying.
8. Disconnect filler hose before pressing the pump motor reset button. Hot oil can resume flowing when reset button is pressed.
9. NEVER pump water through pump or use filter pump while cleaning unit.
10. ALWAYS turn off fryer when not in use.

Do not cover or remove this label. N0527

N0160

**WARNING**



Before using this machine, carefully read, understand, and obey

- \* All warnings on this machine
- \* The instruction manual inside the door.

Failure to do so can result in serious injury.

If your manual or the labels on this machine become unreadable or lost, or if you need other assistance, call or write BKI, 1-864-963-3471

Do not cover or remove this label. N0160

N0153

**WARNING**



**ACME SCREW AND NUT**

1. Check for wear and excessive looseness.
2. Screw should be oiled every 30 days.
3. **IMPORTANT:** At least every six months remove screw and nut to inspect for excessive wear in threads; or, if at any time a sign of wear appears, replace at once to insure maximum efficiency and safety of operation.
4. Do not over-tighten spindle assembly (only tighten to hold pressure).
5. For service, contact your local BKI Distributor, or BKI P.O. Box 85400 Simpsonville, SC 29680-0400 Phone: 1-864-963-3471

Do not cover or remove this label. N0153

N0163

**CAUTION**



**Remove caps and deadweights. Clean holes daily with brush.**

Do not cover or remove this label. N0163

N0170



N0202



N0059

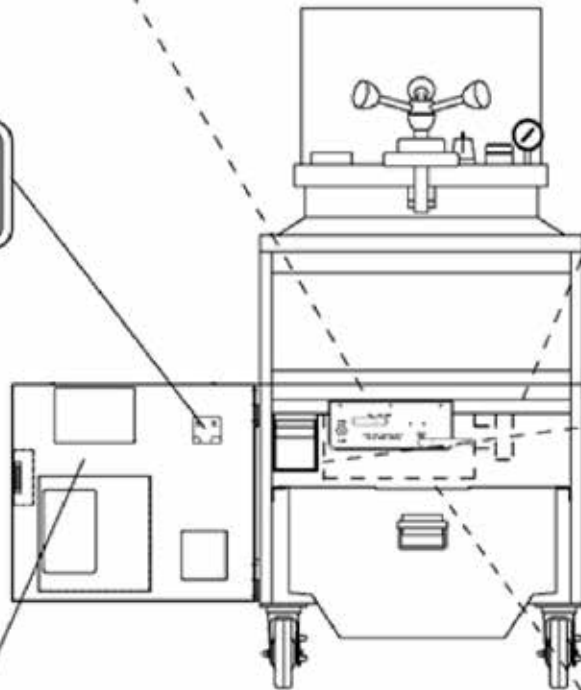
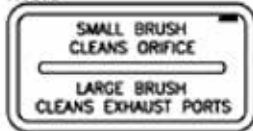

N0168



N0165

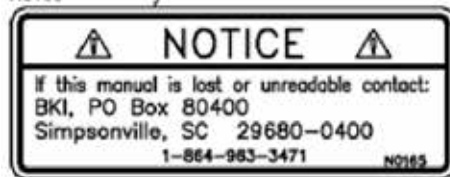

N0395



## INSTALLATION



Serious injury, equipment damage or death could result if attempting to install this fryer yourself. Ensure that an authorized BKI service agent installs the fryer.

### UNPACKING AND HANDLING

It is the owners' responsibility to file all freight claims with the delivering truck line. Inspect all cartons and crates for damage as soon as they arrive. If damage to cartons or crates is found, or if a shortage is found, note this on the bill of lading (all copies) prior to signing.

If damage is found when the equipment is opened, immediately call the delivering truck line and follow up the call with a written report indicating concealed damage to your shipment. Ask for an immediate inspection of your concealed damage item. Packaging material **MUST** be retained to show the inspector from the truck line.

### INSTALLATION PROCEDURE



Ensure that an authorized BKI service agent installs the fryer. An authorized BKI service agent should be a qualified gas service technician and a licensed electrician.

1. Remove the shipping packing materials from the interior and exterior of the fryer.
2. Remove the shipping packing clip from underneath the dead weight cap and discard.

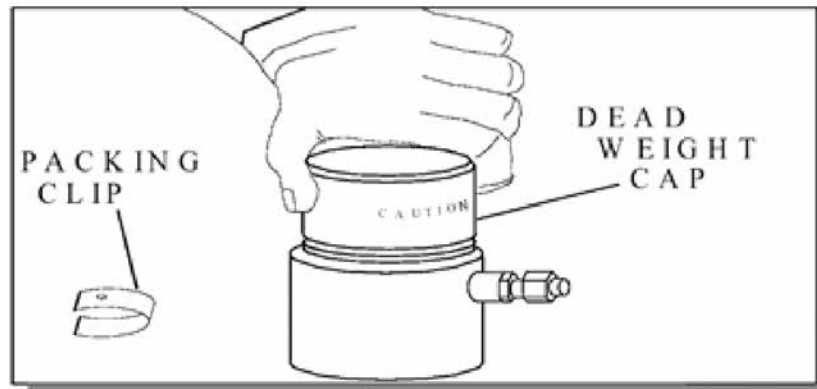

3. Replace the dead weight and cover.



Risk of electric shock – Fryer must be secured to building structure. Follow restraining device instructions for proper installation.

4. Install an ANSI Z83.11/CGA 1.8 compliant restraining device (such as BKI part number [FT0279](#)) per the instructions below:
  - Mount the wall attachment according the restraining device manufacturer instructions.
  - Attach the spring-loaded hook on the restraining device to the eye-bolt mounted to the fryer then attach the other spring-loaded hook to the wall attachment.

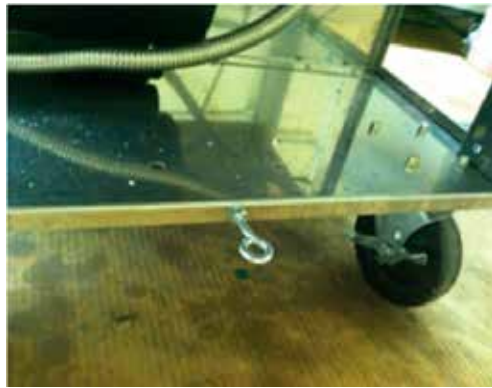

5. Lock the casters so the fryer does not move. Every time the fryer is used, make sure the casters are locked so the fryer cannot move.
6. Clean the fryer pot before filling with shortening. See boil out procedure.
7. Place the DRAIN handle in the CLOSED position.

## WIRING



Electrocution, equipment failure or property damage could result if an unlicensed electrician performs the electrical installation. Ensure that a licensed electrician performs the electrical installation in accordance with local codes, or in the absence of local codes, with the National Electrical Code, ANSI NFPA 70-20XX.

This unit, when installed by an authorized BKI service agent, must be wired for use in accordance with all applicable local, state, and federal codes. For specific electrical requirements and connections refer to the wiring diagram attached to the unit or provided in the Service Manual.

**INITIAL TEST AND ADJUSTMENT**

1. Place the DRAIN handle in the CLOSED position.
2. Fill pot with shortening to above the “MIN OIL LEVEL” mark.

**WARNING**

Risk of fire exists if the oil level drops below the minimum oil level. The level of oil within the pot must not fall below the minimum indicated level.

**WARNING**

Risk of electric shock – Fryer must be secured to building structure. Follow restraining device instructions for proper installation.

**CAUTION**

Overfilling the fryer pot with shortening could lead to serious injury. Ensure that the fryer pot is filled with shortening only to the fill mark when shortening is hot. Do not use any shortening other than what is specified in this manual and do not overfill the fryer pot.

**CAUTION**

The fryer has a maximum temperature setting 375° F/191° C. Do not use oil/shortening with a flashpoint less than 554° F/290° C

**NOTICE**

Use only high-quality shortening that has low moisture content, a high smoke point and no additives.



3. Turn fryer on by touching the ON button for 3 seconds. Follow the startup instruction below. Add more shortening as required to reach the fill mark. Refer to the troubleshooting section if this does not occur.

**CARE OF SHORTENING**

To extend the life of your shortening, for the best possible flavor in your products, and for economy and efficiency of operation, we urge you to follow these recommendations:

1. Use only high-quality frying shortening without additives, of low moisture content and with a high smoke point.
2. Press excess moisture from products before breading. The more moisture released in the shortening, the quicker it will break down.
3. Filter at least once a day or once every three loads during frequent cooking.
4. Clean any residue or crust formations from the sides and bottom of the pot each time you filter the shortening.
5. Add fresh shortening as needed to maintain the proper shortening level TO THE FILL MARK ON THE POT WALL.
6. DO NOT HOLD SHORTENING AT HIGH TEMPERATURE when the fryer is not in use. If you expect an elapsed time of one hour or more between cooking, close the lid and let the fryer go into setback. The idle time and setback temperature can be programmed.
7. Shortening changes are determined by the quantity and type of food prepared. Excessive boiling and foaming are definite signs of shortening breakdown.
8. After you have finished frying for the day, filter the shortening and replace the filter pad. Also, thoroughly clean the pot of sediment and crumbs and empty the condensate pan.

## OPERATION

### START-UP (FKM-TC WITH TRAINING CENTRAL™)



1. Turn fryer on by touching the ON button for 3 seconds.



2. Make sure the main drain valve is closed.



3. Fill pot with shortening to above the "MIN OIL LEVEL" mark



Risk of fire exists if the oil level drops below the minimum oil level. The level of oil within the pot must not fall below the minimum indicated level.



Use of oil/shortening older than the manufacturers recommendations for life of the oil is prone to surge boiling and flash fires. Follow the oil manufacturers guidelines for lifecycle of oil/shortening.



Overfilling the fryer pot with shortening could lead to serious injury. Ensure that the fryer pot is filled with shortening only to the fill mark when shortening is hot. Do not use any shortening other than what is specified in this manual and do not overfill the fryer pot.



The fryer has a maximum temperature setting of 375° F/191° C. Do not use oil/shortening with a flashpoint less than 554° F/290° C



Use only high-quality shortening that has low moisture content, a high smoke point and no additives.

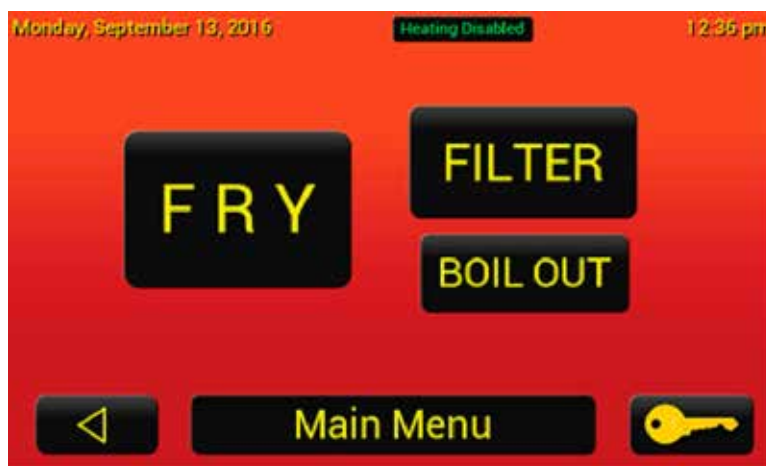

- Once the fryer is filled with shortening, press the FRY button.



- Confirm the oil level by pressing the green check mark.
- The fryer will start heating up by going into a melt cycle. It will pulse the elements until the oil gets to 225° F (107° C) and then goes into heat mode until it reaches the setpoint temperature. The recipes will be greyed out and inaccessible until the fryer reaches setpoint temperature.



7. When the fryer is ready to cook the recipes will be activated

**IMPORTANT!** Before the first cooking operation each day, stir the shortening freely while it is heating to provide a balanced shortening temperature for excellent results with the first cooking. Failure to do this can result in a crusty skin on the product surface with an undercooked product internally. In addition, in some cases, failure to stir the shortening while it is initially heating may cause the HI-LIMIT safety device to disable the power due to a false overtemperature condition.

**COOKING (FKM-TC WITH TRAINING CENTRAL™)**

Do not open the drain valve or the fill valve while the fryer is operating. Serious burns may result.

1. Ensure that the Start-Up procedures have been performed.
2. Press the menu item button for the desired cook.



3. When frying chicken, lower the basket into the shortening in the fryer pot.



Hot shortening may splash out of the pot causing severe injury when dropping chicken into pot. Carefully drop pieces of chicken into pot to prevent shortening splashes.

4. Carefully drop the chicken in the shortening one piece at a time starting with thighs and breasts. The fryer is designed to accommodate 48-50 pieces of chicken.



Failure to use the insulated mitts will result in severe injury. Always use the insulated mitts when handling the hot fry basket.

5. Lift the basket and shake it. This keeps the food from sticking together and causing white spots on the cooked food.



Hot shortening may splash out of the pot causing severe injury when lowering basket into pot. Carefully lower basket into pot to prevent shortening splashes.

6. Slowly lower the fryer basket into fryer pot.
7. Close the lid. Make sure the lid snaps shut. Make sure the lid hook latches securely under the catch.
8. Tighten the spin handle until the lid is firmly sealed. Then line up the orange knob on the spin handle with the orange knob at the front of the fryer.



9. Activate the recipe by pressing the START button. The timer will begin the count down and indicator bar will advance.



(To cancel the recipe press and hold the back button for 3 seconds.)

10. At the end of the frying cycle, the digital timer beeper will sound and the fryer will automatically release pressure into the baffle box. Press the green check mark button.



11. When the pointer on the pressure gauge is at zero, wait 5 seconds then slowly turn the spin handle counterclockwise to break the seal around the lid. The fryer has a locking pin that prevents turning the spin handle until the pressure drops to zero. Do not force the spin handle to open the lid.
12. Slowly open the lid.



Failure to use the insulated mitts will result in injury. Always use the insulated mitts when handling the hot fry basket.

13. Lift the basket and hang it on the front of the fryer pot to drain.
14. Empty the basket.
15. Remember to filter the shortening at least every third frying cycle load. Refer to the procedure in this manual. Also filter the shortening and clean the fryer at the end of each day.
16. When you have finished frying for the day turn fryer off by touching the **OFF** button for 3 seconds.

## PRODUCT PROGRAMMING



1. Press the Key button to get into the settings menus.



2. Enter code **1234** and then press the green check mark.



3. Select the **Edit Recipe** button.



4. Select the Recipe that needs edited.



5. In the Edit Recipe screen the name, cook time, temperature, timing type, & picture can be edited.



6. Select **Name** to change the name and press the green check mark to save.



7. Select **Frying** to edit the time and temperature of the recipe. Press the green check mark to save.



8. Pressing the **Next** button will bring you to the second page where the shake/stir, alarm, if the program is active, and the filter weight can be edited.



9. Press the **Shake/Stir** time to edit the time & number of beeps. Press the green check mark to save.



10. Press the alarm time to edit the time. Press the green check mark to save.



11. Make sure the program is active and set the filter weight (1.0-12.0 by 0.5 increments, if using global filtering).

12. When done, press the **SAVE** button to save the program.



13. If you want to cancel the recipe or accidentally press the back button, the message above will display. You can save by pressing the SAVE or cancel by pressing the back arrow.

**SET OIL TEMP**

1. Get into the supervisor menu and select the **Set Oil Temp** button.



2. Set the oil temperature to the desired ready to cook temperature between 250° F and 375° F.
3. Press the green check mark to save.

**SET CLOCK**

1. Get into the supervisor menu and select the **Set Clock** button.



2. Set the date & time.
3. Press the green check mark to save.

## SETTINGS



1. Get into the supervisor menu and select the **Settings** button.



2. Set the Beeper Volume (Low or High), Pattern (1, 2, or 3), the Filter Lockout\* can be turned off & on, the Filter Lockout Value can be set (2-20), and the Temperature Units can be set (C or F).

\*The filter lockout is a global counter used to determine when to force filter. Set the total filter value in settings and then in the recipes, the weight of each recipe can be set. (i.e. Fresh breaded product can have a value of 3 and french fries a value of 1.) When the values of the recipes cooked adds up to the global value (or over), the control will require a filter.

3. Press the green check mark to save.

**FRYING LOG**

1. Get into the supervisor menu and select the **Frying Log** button.



2. The frying log will record the following events:
  - Recipe Cooked with elapsed time and average temperature
  - Basic Filter with filtering time, refill time, and number of pump lockouts
  - Filter With Rinse Hose with filtering time, refill time, and number of pump lockouts
  - Boil Out with heating time
3. Press the back button to exit.

## MACHINE LOG



1. Get into the supervisor menu and select the **Machine Log** button.



2. The machine log will record the following events:

- Touchscreen Error
- Probe Error
- Nonvolatile Memory read, write, or data errors
- Factory Reset
- Touchscreen Calibration
- Configuration Change
- Password Error
- Password Reset
- Password Change
- Recipe Saved
- Recipes Imported
- Recipes Exported
- Configuration Import
- Configuration Export
- Frying Log Export
- Machine Log Export
- USB Drive read, write, and file open errors
- Touch Configuration Change
- Fryer Options Changed
- Firmware Update

3. Press the back button to exit.

## IMPORT/EXPORT



1. Get into the supervisor menu and select the **Import/Export** button.



2. Insert a USB drive.



3. Press the import/export recipes button to save the recipes to a USB or copy to the fryer.



1. To add up to 8 additional Recipe Icons, press the **Import Icons** button with the USB inserted.
2. Importable Image Requirements:
  - a. JPG images only, standard 24 bit color with any amount of image compression.
  - b. Recipe icons must be 64 pixels wide and 64 pixels tall.
  - c. The maximum file size is 54k bytes.
  - d. File names can be any combination of letters and numbers up to a maximum of 8 characters, the extension must be “.jpg”. The name is case insensitive.
3. Touch the Find Files ... button, the controller will look through the entire USB drive and find all jpg files which are 64x64 pixels and below the maximum file size, displays the file name and image of the first file found meeting those criteria, and shows the number of files found in the Find Files ... button. The 8 locations to the right will now be available, locations which already have an icon stored in them will display the stored image. Use the up and down arrows to scroll through all the files the controller found until the file wanted is displayed.
4. Select the location in which they want to store the icon, they can choose any of the eight locations including those which are already in use, that location will be overwritten. The selected location button turns green and the green check button is now available. Touching the green check button stores the selected image into that location in the controller image format along with the name and size of the file and the original jpg file data so it can be exported at some other time.
5. When the import is completed the controller chirps twice indicating that it has stored that icon. Select other icon files and other icon locations and store as many of the images as desired.
6. Press the green check mark to save.



7. To copy any or all 8 Recipe Icons, press the Export Icons button with the USB inserted.
8. The eight button on the left side display all the imported user icons. Select or deselect any of the 8 images to be exported just by touching the icon buttons. Touch once to select, touch again to deselect. The **Select All** button can be used to select all imported icons.
9. Touch the green check button to export all of the selected icons with their original file names and data to the USB drive.  
*NOTE: Files already on the flash drive which have the same name as the original files will be overwritten with the stored image data.*
10. Press the green check mark to save.

**CHANGE CODE**

1. Get into the supervisor menu and select the **Change Code** button.



2. Enter the new 4 digit access code. We recommend an easy to remember number, like the store number.
3. Press the green check mark to save.

## TOUCHSCREEN



1. Get into the supervisor menu and select the **Touchscreen** button.

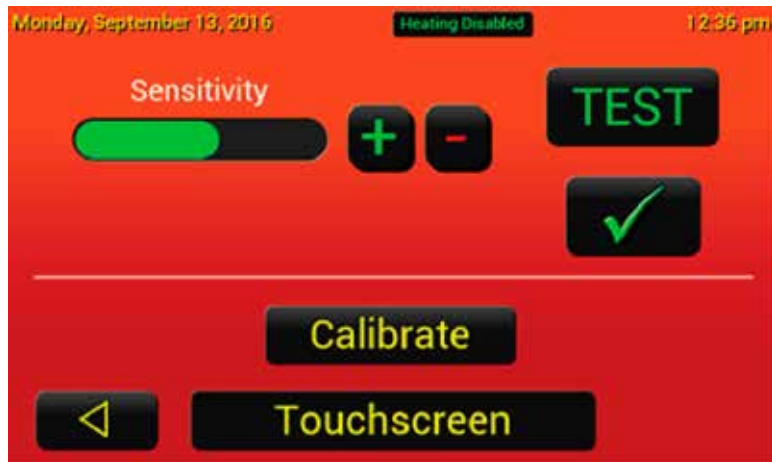

2. Press the + or - buttons to adjust the screen sensitivity. Press the TEST button to verify the sensitivity level.

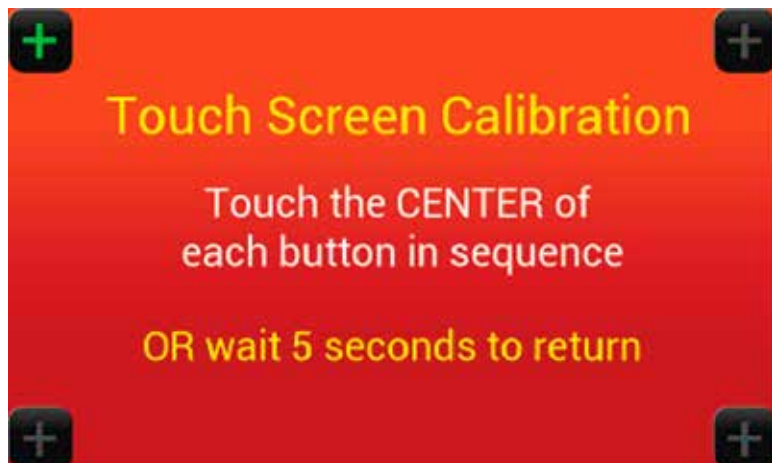

3. Press the Calibrate button to re-calibrate the touchscreen
4. Press the green check mark to save.

## MAINTENANCE



Failure to comply with the maintenance below could result in a serious accident.

Do not over-tighten the spindle assembly. (Only tighten to hold pressure.)

Your fryer will need periodic maintenance and servicing. We strongly suggest that you use only a service company that is authorized by BKI to do this work.

The FKM appliance is not intended to be cleaned with a water jet.

The restraining device must always be connected when the appliance is in service. Disconnect for movement, such as servicing or cleaning. Reconnect the restraint when fryer has been returned to its normal position.

### SCHEDULED MAINTENANCE

Use the following table to help manage scheduled maintenance activities.

FREQUENCY	PERFORMED BY	PART	ACTIVITY
<b>Each Fry Cycle</b>	User	Pressure Gauge	Check for proper display of cooking vat pressure. Contact authorized BKI service agent if adjustment or replacement is required.
	User	Lid Gasket	Check for unusual wear such as cracks and deformation, and pressure leaks. Contact authorized BKI service agent if adjustment or replacement is required.
<b>Daily</b>	User	Dead Weight Assembly	Clean weight and orifices daily and check for wear.
	User	Filter Pad	Replace filter pad. Refer to the procedure in this manual.
	User	Condensation Pan	Remove and drain.
	User	Filter system	Filter the shortening using the procedure in this manual.
<b>Weekly</b>	User	Safety Pop Valve	Check for release of pressure and proper seal. Refer to the procedure in this manual.
	User	Fryer Pot	Perform the boil-out procedure in this manual.
<b>Every 6 Months</b>	Authorized BKI service agent	Acme Screw and Nut	Check for wear on the threads.
	Authorized BKI service agent	Solenoid Valve	Check that the valve is holding and releasing pressure when the timer or computer activates it.
	Authorized BKI service agent	Hook, Catch, Spring	Check for wear and ease of operation.
	Authorized BKI service agent	Connections, Fittings	Check for leakage while oil is pumping.
	Authorized BKI service agent	Fryer Pot Fittings/ Connections	Check for leakage around fry pot top deck and fittings (heaters, hi-limit, thermostats, etc.).

**SAFETY POP VALVE PROCEDURE**

The safety pop valve should be blown under pressure periodically to prevent the seat from sticking.



Failure to use the insulated mitts will result in injury. Always use the insulated mitts when handling the arm on the safety valve.

1. After the pressure is up during a cooking cycle, use the insulated glove to lift the arm on the edge of the safety valve and let some steam escape. This will clean the valve.

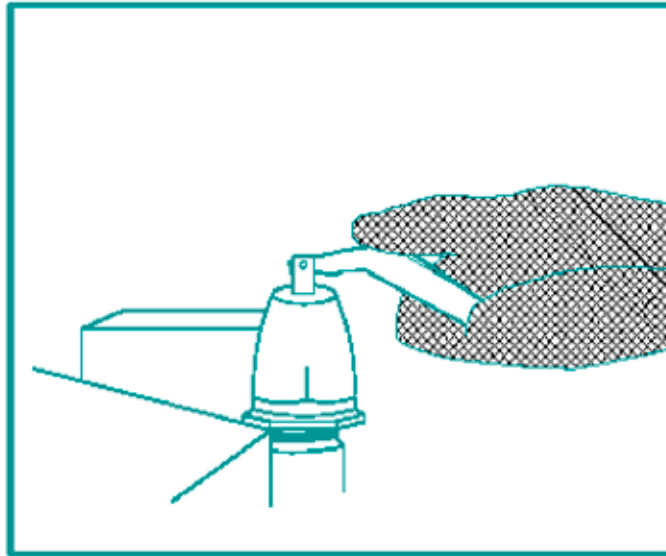

2. Release the lever on the valve, and let it slam shut to seal the valve.

## FILTERING PROCEDURE

Breaded foods require frequent filtering. An excess amount of breading left in the fryer pot will reduce the life of the shortening. We recommend the shortening be filtered after every three frying cycle loads. When the shortening starts to show signs of foaming and has a bad taste, do not use it. The fryer pot should be cleaned before refilling with new shortening. Best results for filtering are obtained while the shortening is hot. You should filter at the end of every business day. You should also remove and drain the condensation pan daily. (If the filter pump overheats and you get a **Pump Too Hot**, see the Filter Pump Reset instructions in the Troubleshooting section.)

If Filter Lockout is ON, then once the value has been reached the following screen will appear and filtering will be required.



Always wear appropriate personal protection equipment during the filtering process to guard against possible injury from hot oil.



Do not open the drain valve or the fill valve while the fryer is under pressure. Serious burns may result.

1. Remove the fryer basket.
2. Make certain that the filter pad is clean and not torn.

**IMPORTANT:** Make certain the vat cover is properly positioned underneath the drain valve. Also make certain the filter vat and filter screen is under the main drain valve before starting.



3. To get to the filter menu, press the back button.



4. Press the **FILTER** button to get the Filter Menu.



5. Press the **FILTER** or **TUTORIALS** button.



6. If you press the **TUTORIALS** button you can go through how to assemble the filter, how to do basic filter and how to filter with the rinse hose. None of the pump functions will operate in the tutorials.

**BASIC FILTER**



7. If you press the **FILTER** button you can do a basic filter or a filter with rinse hose. Below we will go through a basic filter.



Pot

Pan



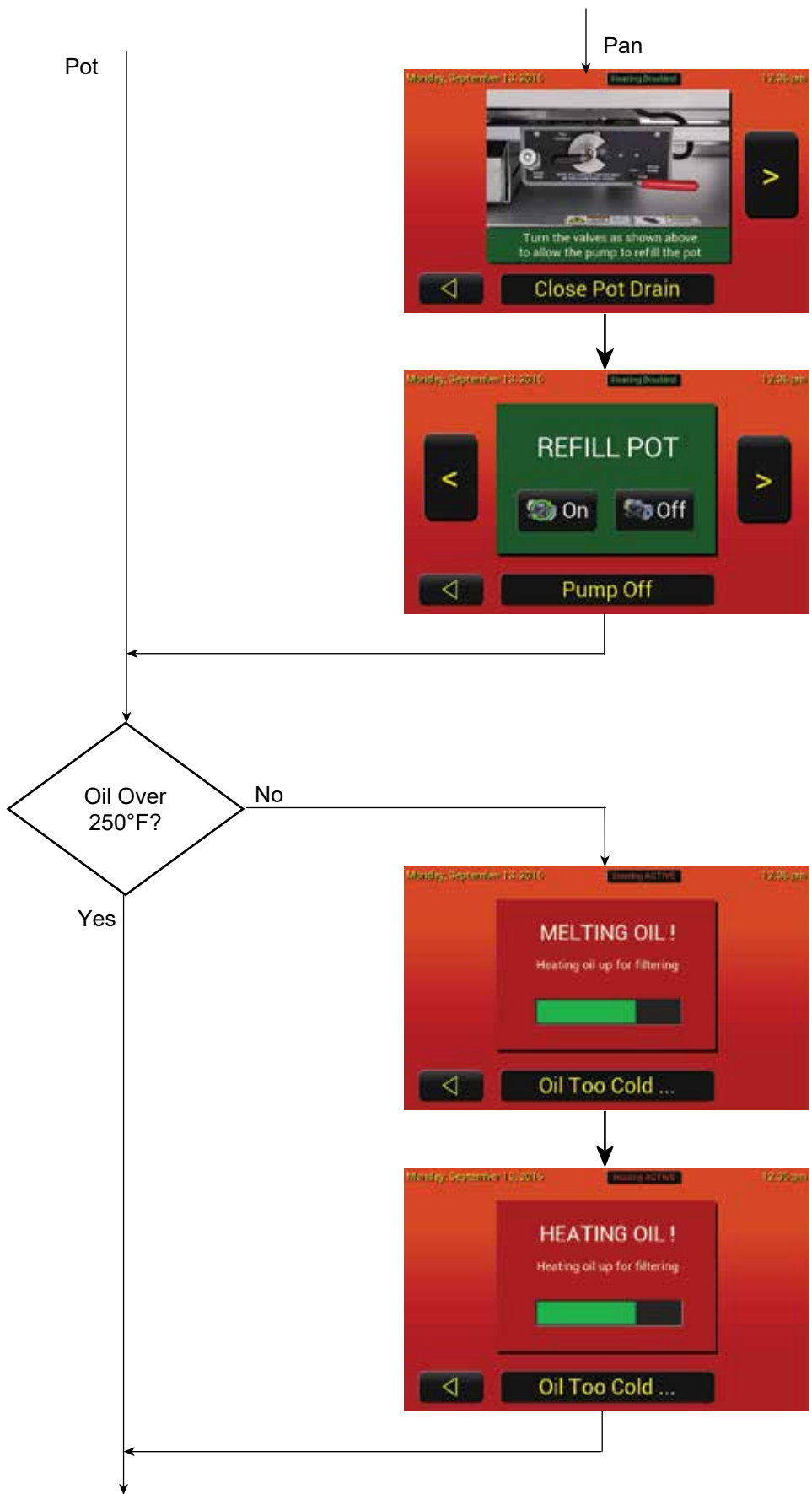



8. Open the pot drain slowly so that the shortening starts to flow evenly. This is to prevent excessive splashing of hot shortening.



9. Clean the pot, elements, & drain with the supplied brushes as the oil drains.



10. If polishing the shortening is desired make sure the fill handle is THRU POT and press the **On** button, otherwise press the right arrow.



11. The display will count up the time the pump is on to indicate the duration of the polishing. When done press the **Off** button to stop the pump and press the right arrow button.



12. To refill the pot close the pot drain and make sure the fill handle is THRU POT.



Always wear appropriate personal protection equipment during the filtering process to guard against possible injury from hot oil.

13. Press the **On** button to start the pump and refill the pot.



14. The display will count up the time the pump is on to indicate the duration of refilling of the pot. Let the filter continue to pump the shortening until air starts bubbling through the shortening. When done press the Off button to stop the pump and press the right arrow button.



15. Add new shortening if the fill mark has not been reached.

## FILTER WITH RINSE HOSE



1. If you press the **FILTER** button you can do a basic filter or a filter with rinse hose. Below we will go through a filter with rinse hose..



Pot

Pan



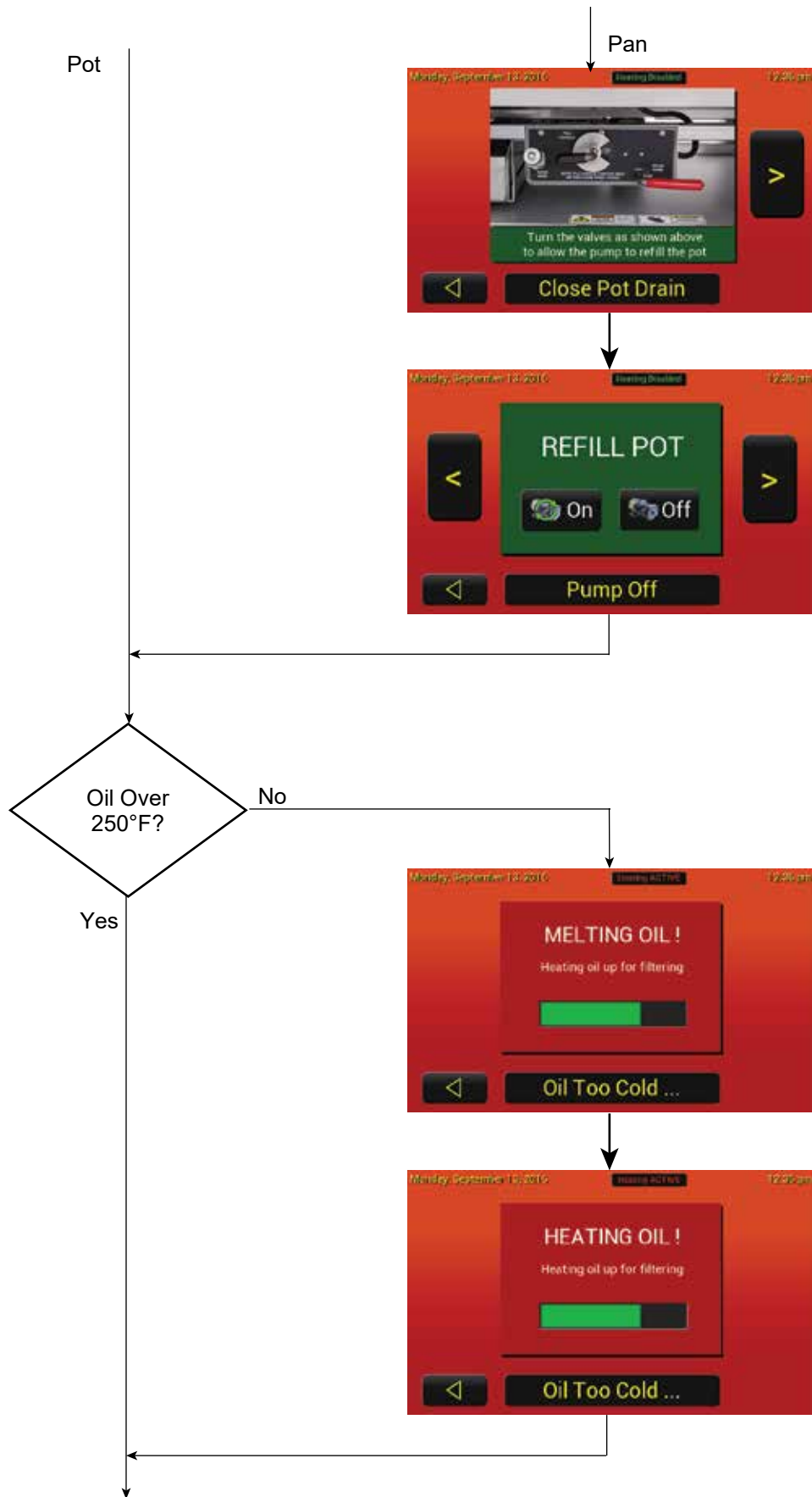



2. Open the pot drain slowly so that the shortening starts to flow evenly. This is to prevent excessive splashing of hot shortening.



3. Clean the pot, elements, & drain with the supplied brushes as the oil drains.



4. Make certain that the rinse hose is connected to rinse hose connector and the valve is turned to the THRU HOSE position.



5. Holding the hose by the handle, place hose nozzle inside the pot and press the **ON** button to start the pump.

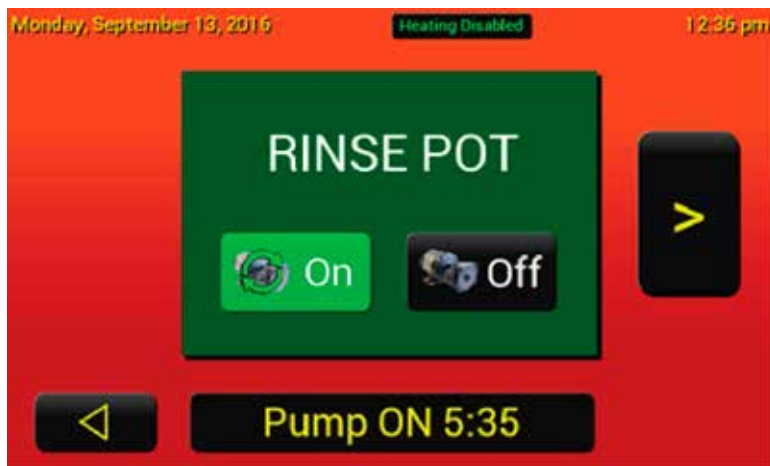

6. Rinse the inside of the pot with the hose, press **Off** button when done.



7. To refill the pot, disconnect the hose, close the pot drain, and make sure the fill handle is THRU POT.



Hot shortening may splash out of the pot causing severe injury when filling the pot.

8. Press the **On** button to start the pump and refill the pot.



9. The display will count up the time the pump is on to indicate the duration of refilling of the pot. Let the filter continue to pump the shortening until air starts bubbling through the shortening. When done press the **Off** button to stop the pump and press the right arrow button.



10. Add new shortening if the fill mark has not been reached.

**BOIL OUT**

Boil-outs remove microscopic particles of carbon that build up on the walls of the fryer pot. To avoid eventual carbon build-up, off flavors, and shortening breakdown, boil-outs should be done once a week on each fryer following these procedures. BKI recommends BKI Cleaner (P/N LC0006) or equivalent.



Always wear appropriate personal protection equipment during the boil-out process to guard against possible injury from hot cleaning solution.



1. Press the **BOIL OUT** button to get the Boil Out Menu.



2. Press the **BOIL OUT** or **TUTORIAL** button.



3. Open the pot drain slowly so that the shortening starts to flow evenly. This is to prevent excessive splashing of hot shortening.



4. Close the pot drain, fill the pot with water to the fill line, & add the cleaning product.



5. Confirm the water level and press the **START** button.



6. The water will heat up to 190° F.



7. Once the water has reached temperature and 2 minutes have passed the control will beep until the green check mark is pressed. Clean the pot and lid with the brushes provided.



8. Let sit for a little bit and repeat the cleaning with the brushes. Continue till the pot is clean.



9. **Before draining the cleaning solution**, remove the filter bag, screen and pipe connections from the filter vat. This must be done before draining the cleaning solution. **NEVER** pump water or detergent through the filter system.

10. Drain the solution into the filter vat and discard.

11. Rinse the pot with hot water, using the pot brush to remove remaining sediment, drain and discard.

12. Close the drain and refill the fryer pot with hot water to the proper level.

13. Add approximately 4 to 6 ounces of distilled (white) vinegar to develop a neutralizing solution. Stir the solution briefly. Leave in the pot for three to five minutes and discard.

*NOTE: Foaming of shortening after boil-outs is caused by failure to follow proper neutralizing procedures.*

14. Repeat steps 11 through 13 as needed to remove all traces of cleaning solution.

15. Rinse the pot again with Cool water, drain and discard.



Damage to the fryer could result if the fryer pot is not completely dry before filling with shortening. Refill the fryer pot with shortening **ONLY** when it is completely dry.

16. Dry the fryer pot, lid, and filter vat **COMPLETELY**.

17. Close the main drain and fill with new shortening to the proper level.



18. Confirm the oil level.

**FILTER PAD REPLACEMENT**

The filter pad must be replaced daily. If the shortening has a milky color when it is pumped into the pot, the filter pad should be replaced immediately.



If the filter pad is not properly closed, breading crumbs will get through the pad opening and clog the pump. Ensure that the filter pad is properly closed upon replacement.



1. Clean all the filter screens and tubing and get a new filter envelope.



2. Slide the filter into the filter envelope. Be careful to not tear or puncture the envelope.



3. Fold the open end of the envelope over and install the retaining clip.



4. Place the top screen over the assembly and check that the pickup hole is clear.



5. Install the pickup tube and hand tighten. Make sure the filter envelope is not torn.



6. Install the filter assembly into the filter vat. Place the filter vat lid on and slide the filter vat back into fryer.

**TROUBLESHOOTING**

Refer to the table below for troubleshooting information.

<b>PROBLEM</b>	<b>CAUSE</b>	<b>POSSIBLE SOLUTION</b>
<b>Pressure Loss or Not Releasing Pressure</b>	Dead Weight Valve Leaking	Clean the weight and orifice. If problems persist, contact an authorized BKI service agent for corrective action.
	Lid Gasket Leaking	Contact an authorized BKI service agent for corrective action.
	Solenoid Valve Leaking or Stuck	After a period of time, it is possible that the valve seat and/or plunger may stick or wear. Activate the valve by starting a cook cycle. You should hear a solid metallic CLICK sound from the solenoid valve. If you should hear no sound (or a slow BUZZING CLICK), contact an authorized BKI service agent for corrective action.
	Safety Valve not seating	Contact an authorized BKI service agent for corrective action.
<b>Shortening Heating Too Slowly</b>	Low voltage or improper voltage	Contact an authorized BKI service agent for corrective action.
	Bad thermostat or loose wires	Contact an authorized BKI service agent for corrective action.
	Weak heating elements or heating elements breaking down	Contact an authorized BKI service agent for corrective action.
	Coil on contactor is bad	Contact an authorized BKI service agent for corrective action.
	Breading build-up on heating elements	Clean heating elements. If problems persist, contact an authorized BKI service agent for corrective action.
<b>Filter System Not Working</b>	Uncertain	Press the hi-limit reset button under control panel. If problems persist, contact an authorized BKI service agent for corrective action.
	Connections not tight	Tighten the connections. If problems persist, contact an authorized BKI service agent for corrective action.
	Filter valve not open	Contact an authorized BKI service agent for corrective action.
	Filter paper on screen clogged with crumbs	Change filter paper. If problems persist, contact an authorized BKI service agent for corrective action.
	Motor hums, but does not pump	Check for clogged pump. If problems persist, contact an authorized BKI service agent for corrective action.
	Motor and pump coupling worn	Contact an authorized BKI service agent for corrective action.
	No power to control panel	Make sure drain valve is completely closed. If problems persist, contact an authorized BKI service agent for corrective action.
<b>Computer Hangs</b>	Computer malfunction.	Turn the power <b>OFF</b> then back <b>ON</b> . If problems persist, contact an authorized BKI service agent for corrective action.

**FILTER PUMP RESET**

If the filter pump overheats a PUMP TOO HOT alert will pop up and a timer will start to count up.



Once the pump has cooled, the screen will indicate that the pump is ready. Press the green Check Mark to start the pump back up.



**NOTES:**

**BKI**

[www.bkideas.com](http://www.bkideas.com)

42 Allen Martin Drive, Essex Junction, Vermont 05452 USA Telephone: (802) 658-6600 Fax: (802)864-0183

## REVISION HISTORY

REVISION	DATE	REVISED BY	DESCRIPTION
01	03/14/18	JDS	Initial Release-Supersedes all previous releases
02	05/14/18	JDS	Added Recipe Icon Import/Export (LCO 18-004)
03	09/18/18	JDS	Added additional Team Central info, updated filter process, and required Warning for California residents. (LCO 18-007)
04	9/1/2020	CF	Change warranty
05	8/20/2021	CF	Update for CE