

Rotisserie Oven

MODEL MSR

Service Manual

Serial Numbers 120161 and Higher



Warranty Information

LIMITED ONE YEAR WARRANTY

BKI (The "Company") warrants to the original purchaser/user, that at time of shipment from the Company factory, this equipment will be free from defect in materials and workmanship. Written notice of a claim under this Warranty must be given within **ONE YEAR AND THREE MONTHS** from date of shipment from the factory. Defective conditions caused by abnormal use or misuse, lack of maintenance, damage by third parties, alterations by unauthorized personnel, acts of God, failure to follow installation instructions or any other events beyond the control of the company will **NOT** be covered under Warranty. The obligation of the Company under this Warranty shall be limited to repairing or replacing (at the option of the company) any part which is defective in reasonable opinion of the Company. The user will have the responsibility and expense of removing and returning the defective part to the Company as well as the cost of reinstalling the replacement or repaired part.

IN NO EVENT SHALL THE COMPANY BE LIABLE FOR LOSS OF USE, LOSS OF REVENUE OR LOSS OF PRODUCT OR PROFIT OR FOR INDIRECT OR CONSEQUENTIAL DAMAGES INCLUDING BUT NOT LIMITED TO, FOOD SPOILAGE OR PRODUCT LOSS. WARRANTY DOES NOT COVER GLASS BREAKAGE. THE ABOVE WARRANTY IS EXCLUSIVE AND ALL OTHER WARRANTIES, EXPRESS OR IMPLIED, ARE EXCLUDED INCLUDING THE IMPLIED WARRANTIES OF MERCHANTABILITY AND FITNESS FOR A PARTICULAR PURPOSE. THIS WARRANTY SHALL APPLY ONLY WITHIN THE CONTINENTAL UNITED STATES, ITS TERRITORIES, AND POSSESSIONS AND IN CANADA.

LIMITED NINETY DAY LABOR WARRANTY

All labor necessary to repair or replace factory defective parts will be performed, without charge, to the end user, by service personnel of a **BKI** Authorized Distributor during the first ninety days after the date of installation of the new equipment.

Replacement parts: Any appliance replacement part, except lamps and fuses, which proves to be defective in material or workmanship within 90 days from date of original installation will be repaired or replaced without charge F.O.B. Factory, Simpsonville, S.C. or F.O.B. authorized distributor.

Table of Contents

Table of Contents	1
Introduction	2
Safety Precautions	2
Safety Signs and Messages	2
Safe Work Practices	3
Health And Sanitation Practices.....	4
Food Handling.....	4
Storage Of Raw Meats.....	4
Coding Cooked Foods	4
Storage Of Prepared Foods.....	4
Safety Labels.....	5
Installation	6
Unpacking and Handling	6
Location and Clearance	6
Wiring	6
Jumper Placement	6
Replacement Parts	7
Assemblies	7
Accessories	20
Components	22
Wiring Diagrams	24
Notes	25

Introduction

Your MSR is a single revolving mild air convection oven. It utilizes a single revolving rotor system to ensure even product cooking. The unit contains a single stage cook and hold computer with 5 customizable cook programs. Electronic controls are provided for powering the unit, turning on inside lights, turning the rotors and resetting the unit. The rotors are removable to allow for easy maintenance and cleaning.

The **BKI** name and trademark on this unit assures you of the finest in design and engineering -- that it has been built with care and dedication -- using the best materials available. Attention to the operating instructions regarding proper installation, operation, and maintenance will result in long lasting dependability to ensure the highest profitable return on your investment.

NOTICE

PLEASE READ THIS ENTIRE MANUAL BEFORE OPERATING THE UNIT. If you have any questions, please contact your **BKI** Distributor. If they are unable to answer your questions, contact the **BKI** Technical Service Department, toll free: 1-800-927-6887. Outside the U.S., call 1-864-963-3471.

Safety Precautions

Always follow recommended safety precautions listed in this manual. Below is the safety alert symbol. When you see this symbol on your equipment, be alert to the potential for personal injury or property damage.



Safety Signs and Messages

The following Safety signs and messages are placed in this manual to provide instructions and identify specific areas where potential hazards exist and special precautions should be taken. Know and understand the meaning of these instructions, signs, and messages. Damage to the equipment, death or serious injury to you or other persons may result if these messages are not followed.

DANGER

This message indicates an imminently hazardous situation which, if not avoided, will result in death or serious injury.

WARNING

This message indicates a potentially hazardous situation, which, if not avoided, could result in death or serious injury.

CAUTION

This message indicates a potentially hazardous situation, which, if not avoided, may result in minor or moderate injury. It may also be used to alert against unsafe practices.

NOTICE

This message is used when special information, instructions or identification are required relating to procedures, equipment, tools, capacities and other special data.

Safe Work Practices



Wear Safe Clothing Appropriate To Your Job

Always wear your insulated mitts when handling hot racks or touch any hot metal surface. If you lose or damage your mitts, you can buy new ones at your local restaurant equipment supply store or from your local **BKI** Distributor.

Always wear non-skid shoes when working around the oven or any other equipment.

Never wear loose clothing such as neckties or scarves while operating this equipment. Keep loose hair tied back or in a hair net while operating this equipment.

Always wear appropriate personal protection equipment during the cleaning process to guard against possible injury from hot cleaning solution.



Beware of High Voltage

This equipment uses high voltage. Serious injury can occur if you or any untrained or unauthorized person installs, services, or repairs this equipment. Always Use an Authorized Service agent to Service Your Equipment.



Keep this manual with the Equipment

This manual is an important part of your equipment. Always keep it near for easy access. If you need to replace this manual, contact:

BKI

Technical Services Department
 P.O. Box 80400
 Simpsonville, S.C. 29680-0400
 Or call toll free: 1-800-927-6887
 Outside the U.S., call 864-963-3471



Protect Children

Keep children away from this equipment. Children may not understand that this equipment is dangerous for them and others.

NEVER allow children to play near or operate your equipment.



Keep Safety Labels Clean and in Good Condition

Do not remove or cover any safety labels on your equipment. Keep all safety labels clean and in good condition. Replace any damaged or missing safety labels. Refer to the Safety Labels section for illustration and location of safety labels on this unit. If you need a new safety label, obtain the number of the specific label illustrated on page 5, then contact:

BKI

Technical Services Department
 P.O. Box 80400
 Simpsonville, S.C. 29680-0400
 Or call toll free: 1-800-927-6887
 Outside the U.S., call 864-963-3471

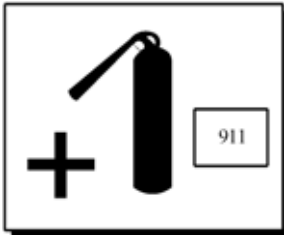

Be Prepared for Emergencies

Be prepared for fires, injuries, or other emergencies.

Keep a first aid kit and a fire extinguisher near the equipment. You must use a 40-pound Type BC fire extinguisher and keep it within 25 feet of your equipment.

Keep emergency numbers for doctors, ambulance services, hospitals, and the fire department near your telephone.

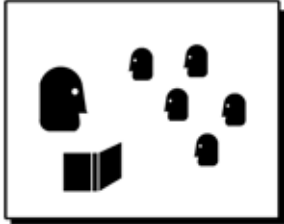

Know your responsibilities as an Employer

- Make certain your employees know how to operate the equipment.
- Make certain your employees are aware of the safety precautions on the equipment and in this manual.
- Make certain that you have thoroughly trained your employees about operating the equipment safely.
- Make certain the equipment is in proper working condition. If you make unauthorized modifications to the equipment, you will reduce the function and safety of the equipment.

Health And Sanitation Practices

BKI Rotisserie Ovens are manufactured to comply with health regulations and are tested and certified to NSF standards. You must operate the equipment properly, using only quality products and use meat thermometers to insure meats are thoroughly cooked.

Food Handling

- Wash hands thoroughly in warm, soapy water after handling raw poultry or meats.
- Clean and sanitize all utensils and surfaces that have been in contact with raw products. Clean and sanitize the meat forks or baskets between cooking.
- **Never** place cooked meats on the same surfaces used to prepare raw meats, unless the area has been thoroughly cleaned and sanitized.

Storage Of Raw Meats

- Designate an area or shelf strictly for the storage of all raw meats to be used in the rotisserie.
- Raw product must always be stored at temperatures below 38° F. (3° C.).
- **Never** store or mix raw foods above cooked foods, as this is a health hazard. The drippings from raw foods contaminate cooked or processed foods.
- All chicken and chicken parts to be stored overnight must be thoroughly iced down and refrigerated.

Coding Cooked Foods

All products cooked during the day should be sold the same day.

NOTE: It is not the intent of the rotisserie program to have unsold merchandise at the end of the cooking day. Follow your company's procedures for the handling of any leftover product.

Storage Of Prepared Foods

- Cold foods should be kept at or below 38° F. (3° C.).
- Hot foods must be maintained to meet local health codes, usually a minimum 145° F. (63° C.).

Safety Labels



N0202

	⚠ DANGER
	HIGH VOLTAGE. Turn power off before servicing. May have more than one disconnect switch. <small>Do not cover or remove label. N0202</small>

N0363

⚠ NOTICE ⚠
This rotisserie oven has been equipped with removable rotors. By spinning the hubs counter-clockwise, the rotors can be easily removed for cleaning. Allow unit to cool to room temperature before cleaning.
<small>N0363</small>

N0542

	⚠ WARNING
	For continued protection against risk of fire and electric shock, replace with 15 Amp fuse only. <small>Do not cover or remove label. N0542</small>

Installation

WARNING

Serious injury, equipment damage or death could result if attempting to install this oven yourself. Ensure that an authorized BKI service agent installs the oven.

Unpacking and Handling

It is the owners' responsibility to file all freight claims with the delivering truck line. Inspect all cartons and crates for damage as soon as they arrive. If damage to cartons or crates is found, or if a shortage is found, note this on the bill of lading (all copies) prior to signing.

If damage is found when the equipment is opened, immediately call the delivering truck line and follow up the call with a written report indicating concealed damage to your shipment. Ask for an immediate inspection of your concealed damage item. Packaging material **MUST** be retained to show the inspector from the truck line.

Remove all packing from the interior and exterior of the oven.

Location and Clearance

Underwriters Laboratories requires that the oven have at least 6" clearance from combustible surfaces at the rear and the left side of the machine.

Wiring

WARNING

Electrocution, equipment failure or property damage could result if an unlicensed electrician performs the electrical installation. Ensure that a licensed electrician perform the electrical installation in accordance with local codes, or in the absence of local codes, with the National Electrical Code, ANSI NFPA 70-20XX.

This unit, when installed by an authorized BKI service agent, must be wired for use in accordance with all applicable local, state, and federal codes. For specific electrical requirements and connections refer to the wiring diagram attached to the unit or provided in the Service Manual.

Jumper Placement

A jumper kit ([AN10514100](#)) has been supplied containing jumpers ([TB0049](#)) and a diagram ([IA10514000](#)). The diagram shows the correct placement of the jumpers for single phase or three-phase connection. The diagram is shown below for reference.

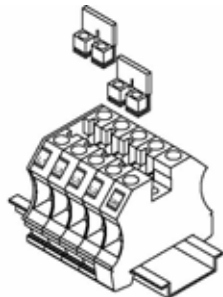

SINGLE PHASE

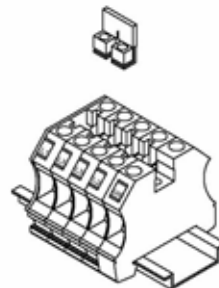

THREE PHASE

Replacement Parts

Use the information in this section to identify replacement parts. To order replacement parts, call your local **BKI** sales and service representative. Before calling, please note the serial number on the rating tag affixed to the unit.

Assemblies

Description	Assembly #	Figure #	Table #
BLOWER (REVERSED) BLOWER (STACKED)	AB10543100 AN10510400	Figure 1	Table 1
CONTROL PANEL CONTROLLER/DECAL	AN10504200 SB5241S	Figure 2	Table 2
FLAT GLASS DOOR	AN10511100	Figure 3	Table 3
INSIDE TOP	AN10510300	Figure 4	Table 4
MICROSWITCH	AN10510900	Figure 5	Table 5
SHAFT ASSEMBLY	NA	Figure 6	Table 6
MOTOR MOUNT MOTOR MOUNT (REVERSED)	AN10504400 AN10511400	Figure 7	Table 7
JUMPER KIT	AN10514100	Figure 8	Table 8

Figure 1. Blower

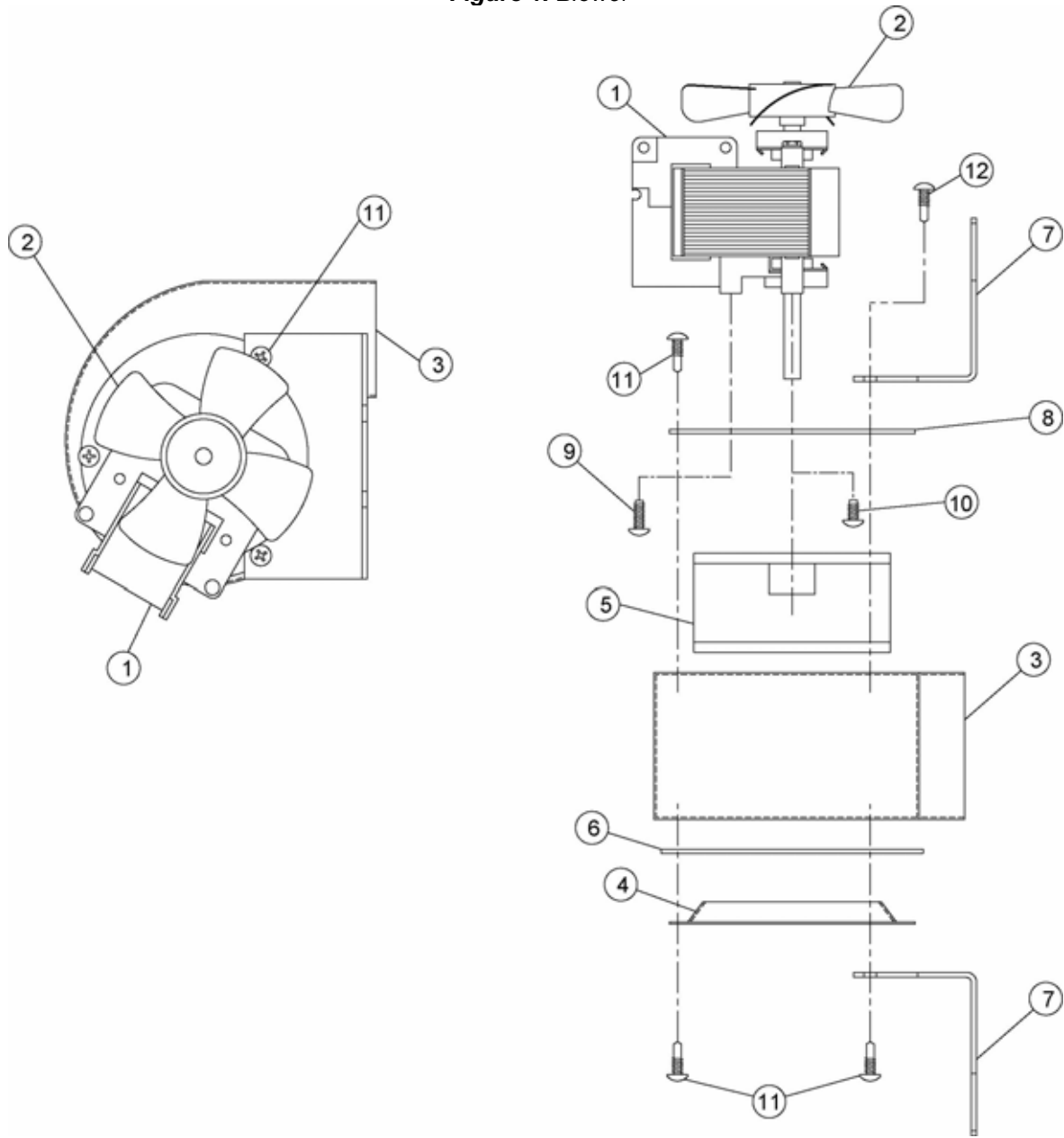

Table 1. Blower Parts

ITEM #	PART #	QTY	DESCRIPTION
1	M0068	1	MOTOR, 208/240V 60 HZ 5A143-33
2	FN0008	1	FAN BLADE, HOWARD #229-77
3	FN0009	1	BLOWER HOUSING #250-C GALV
4	FN0010	1	INLET RING, #303-4 GALVANIZED
5	FN0011	1	BLOWER WHEEL, 3" DIA 1 1/2" W
6	G0085	1	GASKET, SILICONE RUBBER HC
7	FB10509209	2	BLOWER MTG BRACKET, MSR
8	FB57002902	1	BLOWER MTG PLATE
9	SCR323	2	SCREW, 6-32 X 1/2 PHIL RD HD
10	SCR117	2	SCREW, 6-32 X 3/8 PHIL RD HD
11	SCR138	6	SCREW, 10 X 1/2 PHIL TR HD

Figure 2. Control Panel (AN10504200)

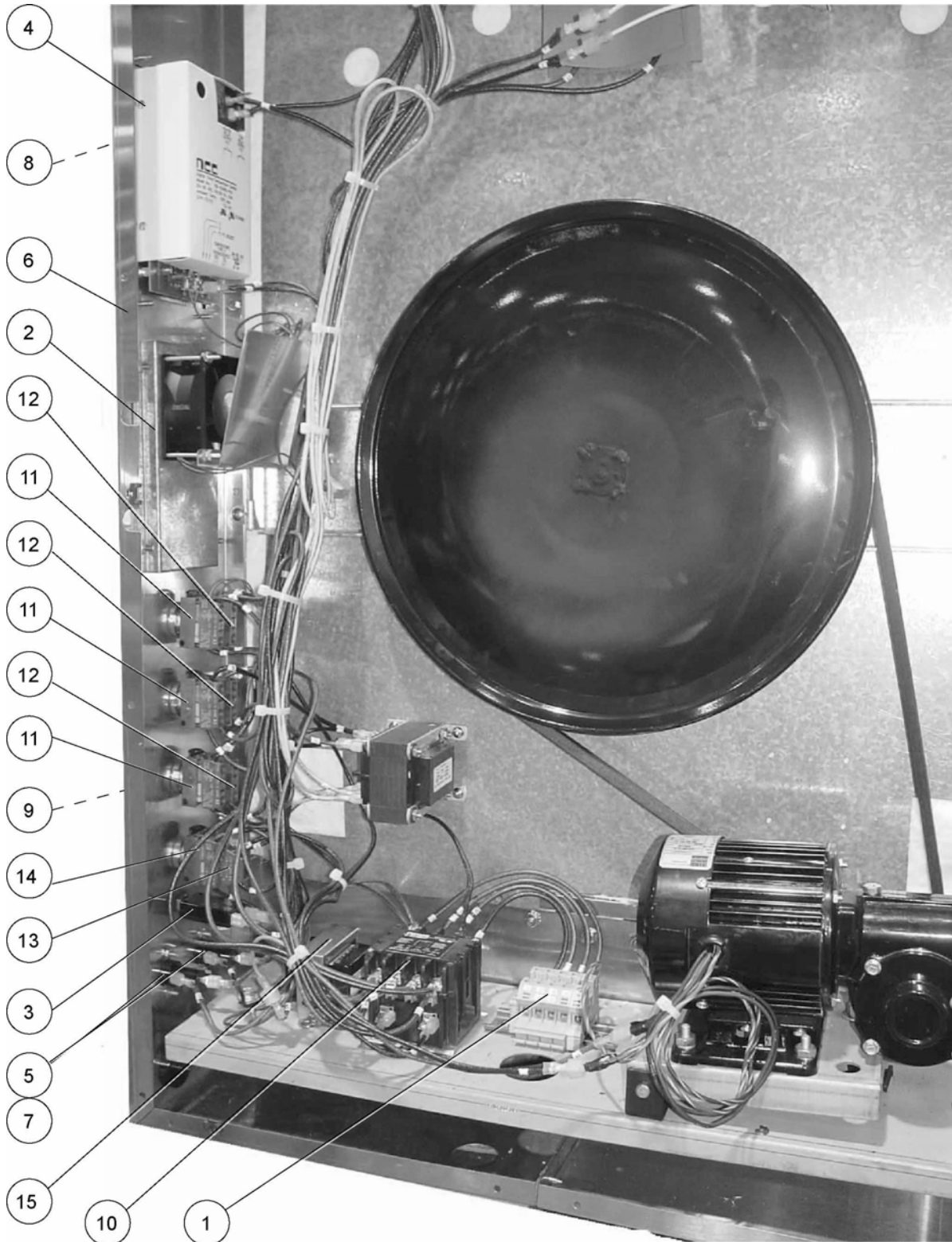

Table 2. Control Panel (AN10504200) Parts

ITEM #	PART #	QTY	DESCRIPTION
1	AN10507300	1	TERM BLOCK ASSY MSR
2	AN10507400	1	COOLING ASSY, CONTROL SIDE MSR
3	CB0050	1	BREAKER, CIRCUIT 3 AMP 250V
4	CP0022*	1	CONTROLLER, DIGT TEMP/TIME
5	F0097	2	FUSE, 15A 300V SC15 TIME DELAY
6	FC10501203	1	CONTROL PANEL, MSR
7	FH0001	2	FUSE HOLDER, 15A 300V HPF-EE
8	N0389*	1	DECAL, CONTROLLER OVERLAY (CP0022)
9	N0437	1	DECAL, CONTROL PANEL MSR
10	R0150	1	RELAY, 4 POLE 208-240 60 HZ
11	S0304	3	SWITCH, 2 POS OPERATOR BLK
12	S0307	6	SWITCH, NO BLOCK GE P9B10VN
13	S0308	1	SWITCH, NO/NC BLOCK GE 9PB11VN
14	S0309	1	SWITCH, MUSHROOM PUSH BLACK
15	TF0030	1	TRANSFORMER, 240-24V LGF

* - Comprises SB5241S.

Figure 3. Flat Glass Door (AN10511100)

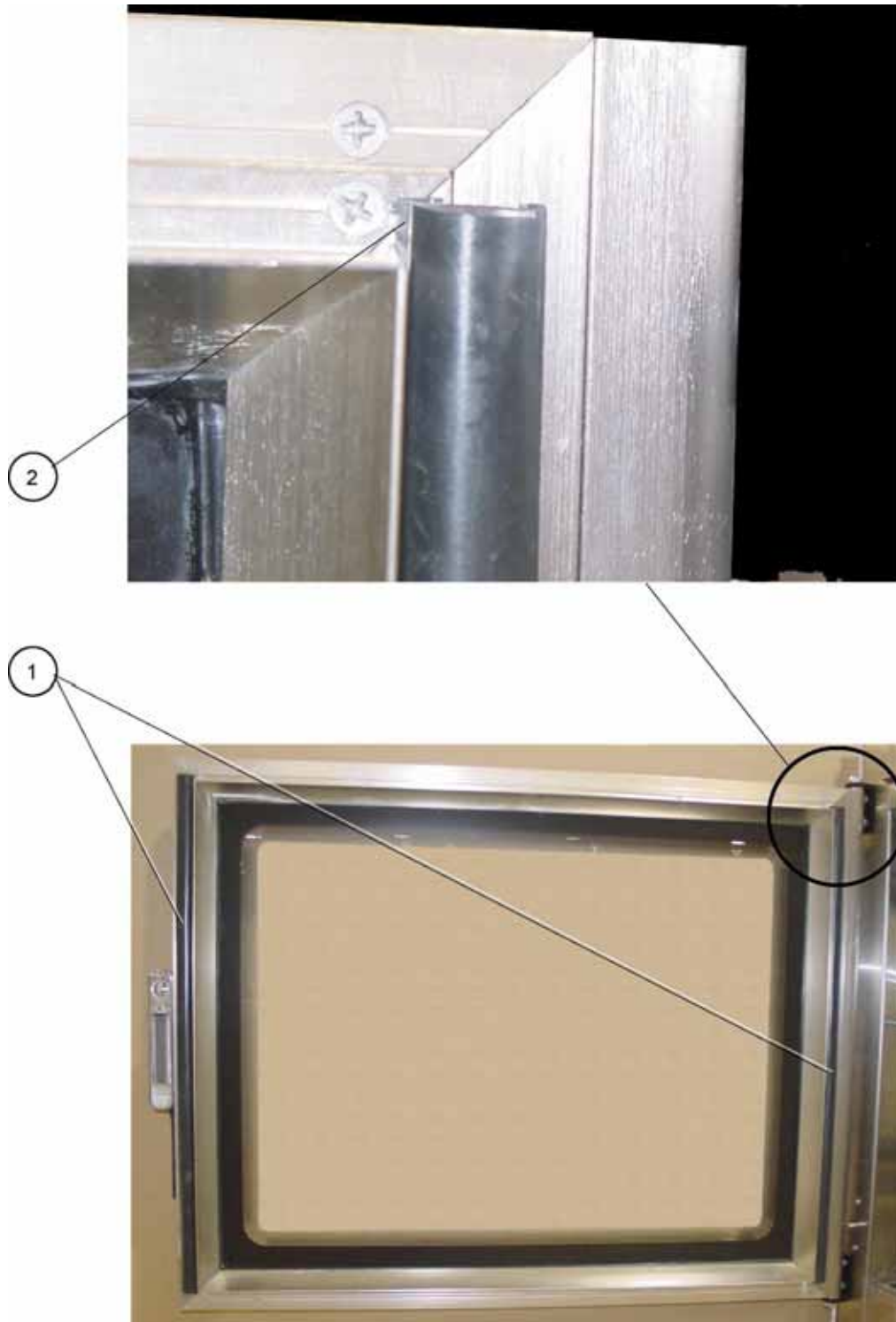

Table 3. Flat Glass Door (AN10511100) Parts

ITEM #	PART #	QTY	DESCRIPTION
1	G0099	4.1ft.	GASKET, DOOR J5195-1
2	MB10503810	2	DOOR GASKET MOUNT, MSR

Figure 4. Inside Top (AN10510300)

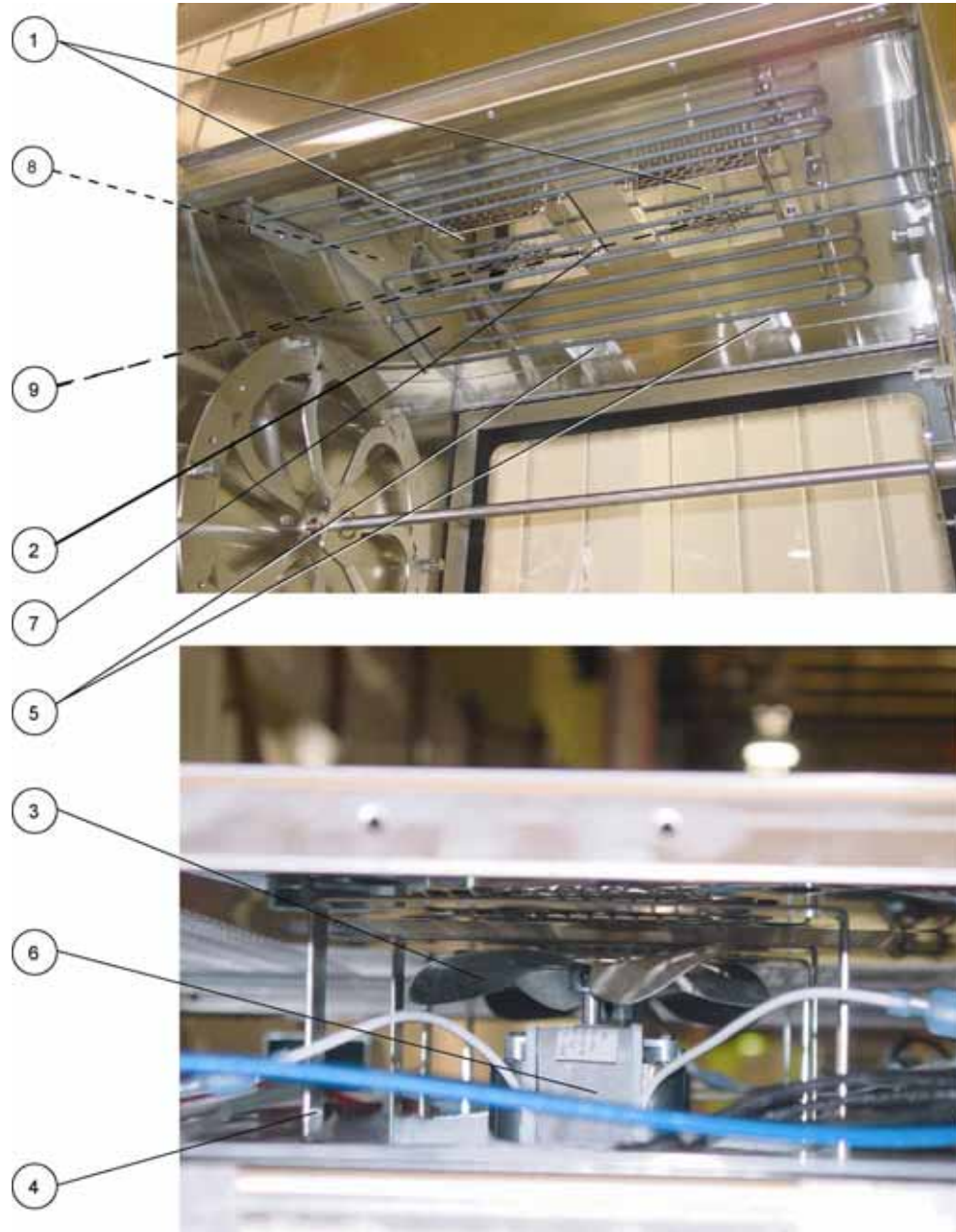

Table 4. Inside Top (AN10510300) Parts

ITEM #	PART #	QTY	DESCRIPTION
1	FB10501101	2	FAN SHROUD, MSR
2	FC10510003	1	INSIDE TOP, MSR
3	FN0022*	2	FAN BLADE, 5" RHF .250-O
4	FSA057	4	FAN OFFSET SUPPORT
5	LH0024	4	LAMPHOLDER W/BULB 12V 20W (OSRAM)
6	M0068	2	MOTOR, 208/240V 60 HZ 5A143-33
7	SCR121	8	SCREW, 10-24 X 3/4 KNURLED BRT
8	T0091	1	THERMOSTAT, HI LIMIT 550+C30F
9	FN0024	2	FAN, 4 3/4 HF .250-Y

* - Not a part of this assembly

Figure 5. Microswitch (AN10510900)



Table 5. Microswitch (AN10510900) Parts

ITEM #	PART #	QTY	DESCRIPTION
1	FB10510818	1	BRKT, MICROSWITCH MSR
2	S0351	1	SWITCH, MICRO 15A
3	S0352	1	SWITCH, ACTUATOR

Figure 6. Shaft Assembly

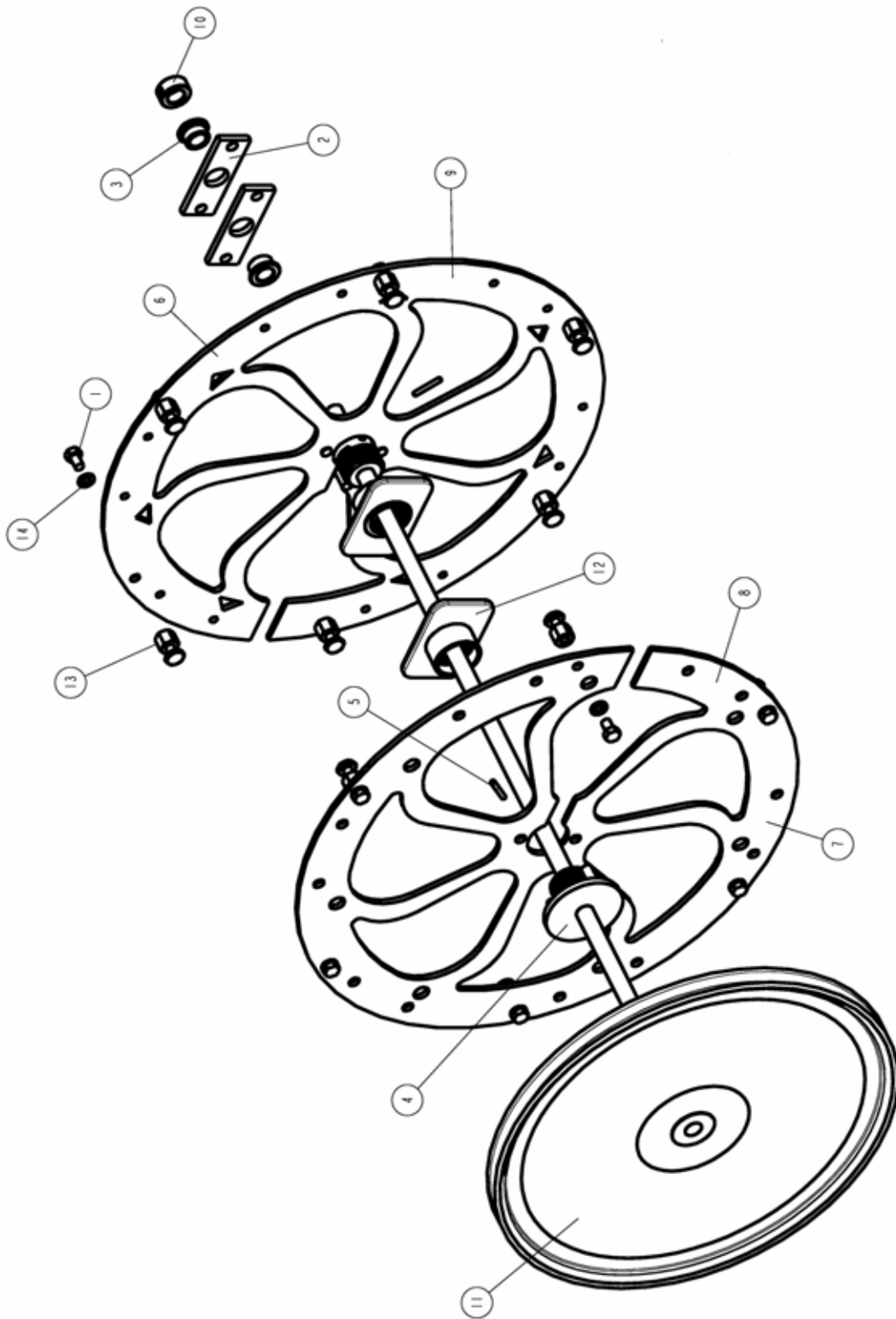

Table 6. Shaft Assembly Parts

ITEM #	PART #	QTY	DESCRIPTION
7	AN10513900	1	ROTOR ASSY, PIN SIDE
13	P0085	6	PIN, STAND OFF 1.125"
8	RO0036	1	ROTOR, PIN SIDE SR MSR (AN10513900)
1	SCR384	12	SCREW, 5/16-18 X 1/2 S/S HEX
14	WSH101	12	WASHER, 5/16 INT LOCK
6	AN10504800	1	ROTOR ASSY, "V" SIDE
13	P0085	6	PIN, STAND OFF 1.125"
9	RO0023	1	ROTOR, POINT SIDE MODULAR UNIT (AN10504800)
1	SCR384	12	SCREW, 5/16-18 X 1/2 S/S HEX
14	WSH101	12	WASHER, 5/16 INT LOCK
2	SRA058	4	BEARING BLOCK 5/8 SHAFT
3	B0242	4	BEARING, .563 ID STYLE SKR
4	H0081	2	HUB, SR KNOCK OFF SPIDER TYPE
5	F0077	2	ROLL PIN, 5/32 X 1 1/8
10	FT0031	1	COLLAR, 5/8 SET LSC-10
11	WN10504600	1	SHAFT/PULLEY WELD
12	H0082	2	SPINNER, SR KNOCK OFF HUB

Figure 7. Motor Mount

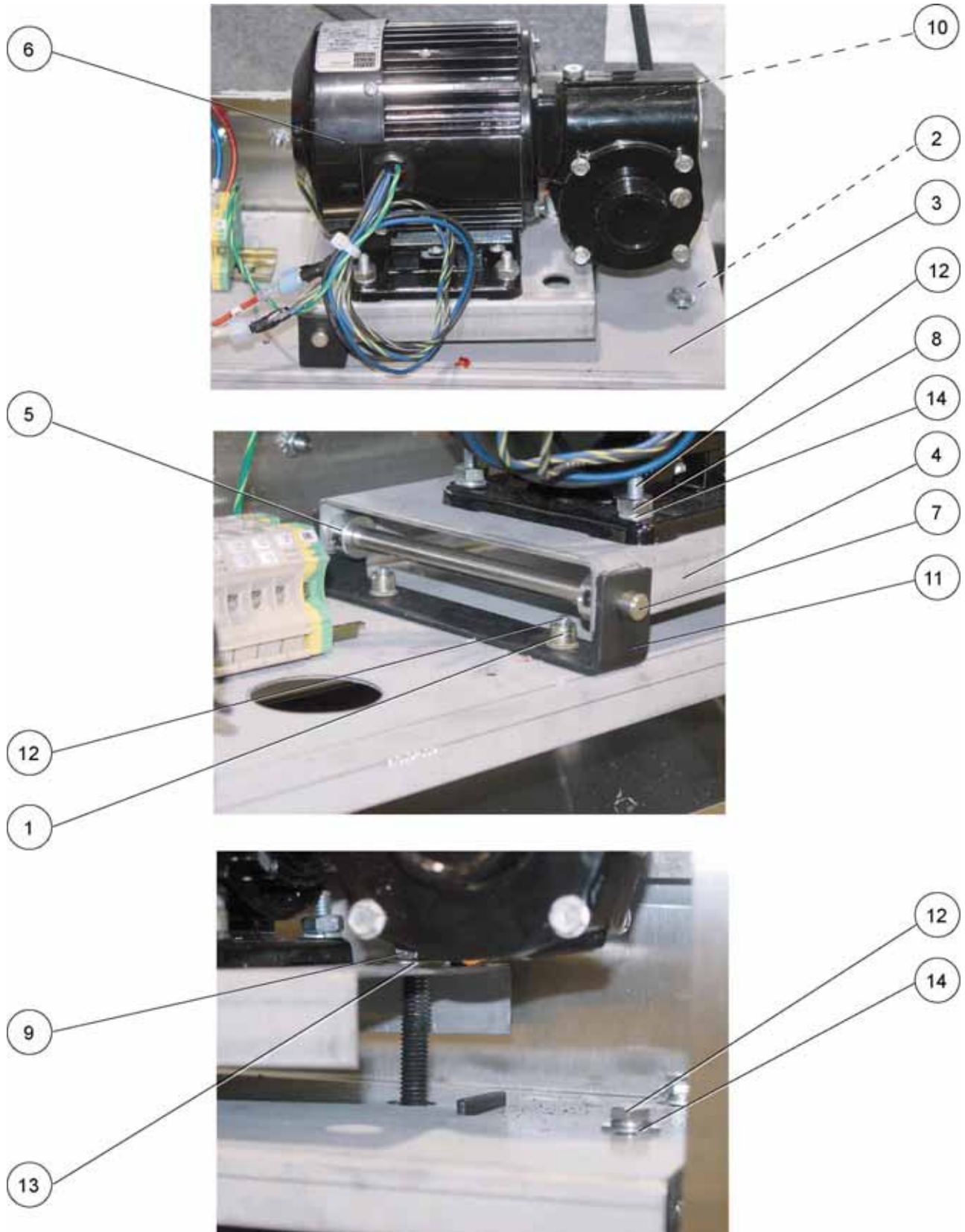

Table 7. Motor Mount Parts

ITEM #	PART #	QTY	DESCRIPTION
1	F0079	6	THREAD INSERT 1/4-20 STEEL
2	FB10502409	2	BRACE, MOTOR BRKT MSR
3	FB10502509 or FB10511209	1	MOTOR BRKT, MSR (AN10504400) or MOTOR BRKT, MSR HINGE LEFT (AN10511400)
4	FB1050230 of FB10511309	1	MOTOR BASE PLATE, MSR (AN10504400) or MOTOR BASE PLATE, MSR HINGE LEFT (AN10511400)
5	FT0032	2	COLLAR, 3/8" LSC-6 RB
6	M0033	1	MOTOR, 208/230V 50/60 CYCLE
7	MA95124402	1	MOTOR MOUNT HINGE PIN, DR
8	NUT053	4	NUT, 1/4-20 HEX HEAVY ZINC PLT
9	NUT096	1	NUT, 3/8-16 STOVER LOCK
10	P0017	1	PULLEY, AS 20 X 5/8
11	PN95124300	1	DR MOTOR MOUNT CHANNEL HINGE
12	SCR059	10	SCREW, 1/4-20 X 3/4 HEX CAP
13	WSH041	1	WASHER, 3/8 USS FLAT
14	WSH044	10	WASHER, 1/4 LOCK ZINC PLTD

Figure 8. Jumper Kit (AN10514100)

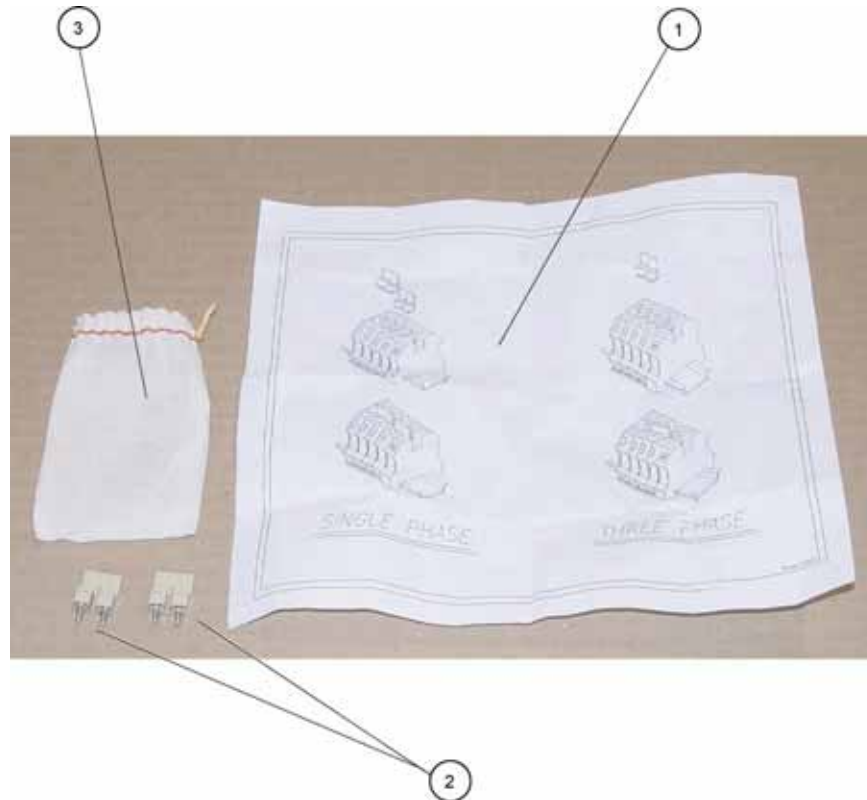

Table 8. Jumper Kit (AN10514100) Parts

ITEM #	PART #	QTY	DESCRIPTION
1	IA10514000	1	JUMPER INSTRUCTIONS MSR
2	TB0049	2	TERM BLOCK 2 POLE JUMPER
3	US0068	1	CLOTH BAG ULINE S-870

Accessories

Description	Part #	Item #
INSULATED MITT 13"	G0052	1
BASKET, MEAT MSR/KS/RC	MB0016	2
BASKET, MEAT W/PRONGS MSR	MB0017	3
MEAT FORK MSR 29.875"	MF0040	4
VEE SPIT MSR 29.375"	MF0042	5
MSR STAND W/CASTORS	311015	6
CORD SET, 7' ALBERTSON SRW MSR	SB0289	7
STACKING KIT	AN10510500	
CASTER, 3" 3-30-521-2 JARVIS (QTY. 4)	C0415	8
THREAD INSERT 1/4-20 STEEL (QTY. 8)	F0079	9
THREAD INSERT 1/4-20 STEEL (QTY. 8)	F0082	10
CASTER BRACE, MSR (QTY. 2)	FB10506702	11
STACK TRIM, CTL PANEL SIDE MSR (QTY. 1)	FB10509703	12
STACK TRIM, OPER SIDE MSR (QTY. 1)	FB10509803	13
LOUVER STACK, SIDE MSR (QTY. 2)	FB10509903	14
SCREW, 8 X 1/2 PHIL TRUSS HD (QTY. 8)	SCR005	15
SCREW, 1/4-20 X 3/4 HEX CAP (QTY. 28)	SCR059	16
STACKING LEG WELDMENT MSR (QTY. 4)	WA10509400	17
WASHER, 1/4 LOCK ZINC PLTD (QTY. 28)	WSH044	18



1



2



3



4



5



6



7



8



9



10



11



12



13



14



15



16

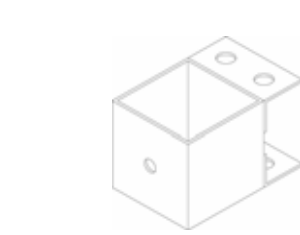

17



18

Components

Description	Part #	Item #
BEARING, .563 ID STYLE SKR	B0242	1
CALROD, 208V 3900W YELLOW CALROD, 230V 3900W ORANGE	C0305 C0306	2
CALROD, 208V 2200W YELLOW CALROD, 230V 2200W ORANGE	C0307 C0308	3
DRIPPING DRAWER ASSY, MSR	AN10504500	4
CALROD BRKT, MSR	FA10504902	5
CALROD BRACE, LARGE MSR	FA10507502	6
CALROD BRACE, SMALL MSR	FA10507602	7
CALROD RETAINER DR34	FB95116302	8
FAN BLADE, 5" RHF .250-O	FN0022	9
LATCH, MAGNETIC COMPOSITE	L0103	10
LOCK FOR L0103 LATCH	L0105	11
TRANSFORMER, 115/230 PRI 80VA	TF0043	12
V-BELT, A-60 TYPE A	VB0017	13
DRIPPING SLIDE WELD, MSR	WB10507200	14
FAN, 4 3/4 HF .250-Y	FN0024	15
BULB, 20W 12V G4HALOGEN OSRAM 64428	B0562	16
LENS, REPLACEMENT FOR LH0024 LAMP	LN0001	17



1



2



3

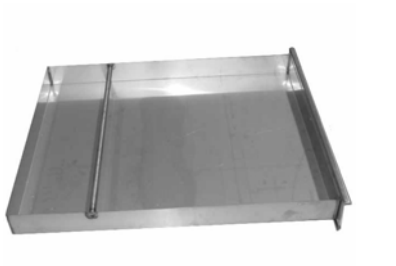

4



5



6



7

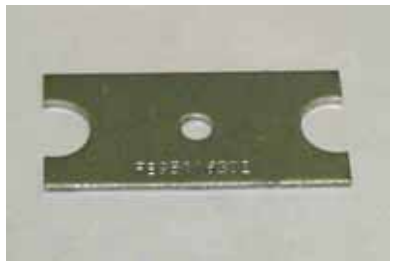

8



9



10



11

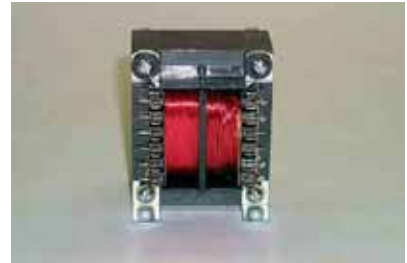

12



13

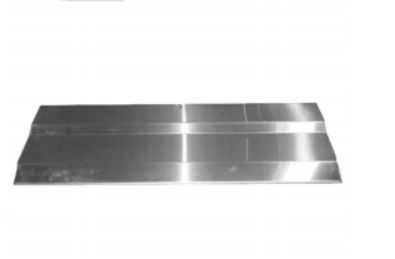

14



15



16



17

Wiring Diagrams

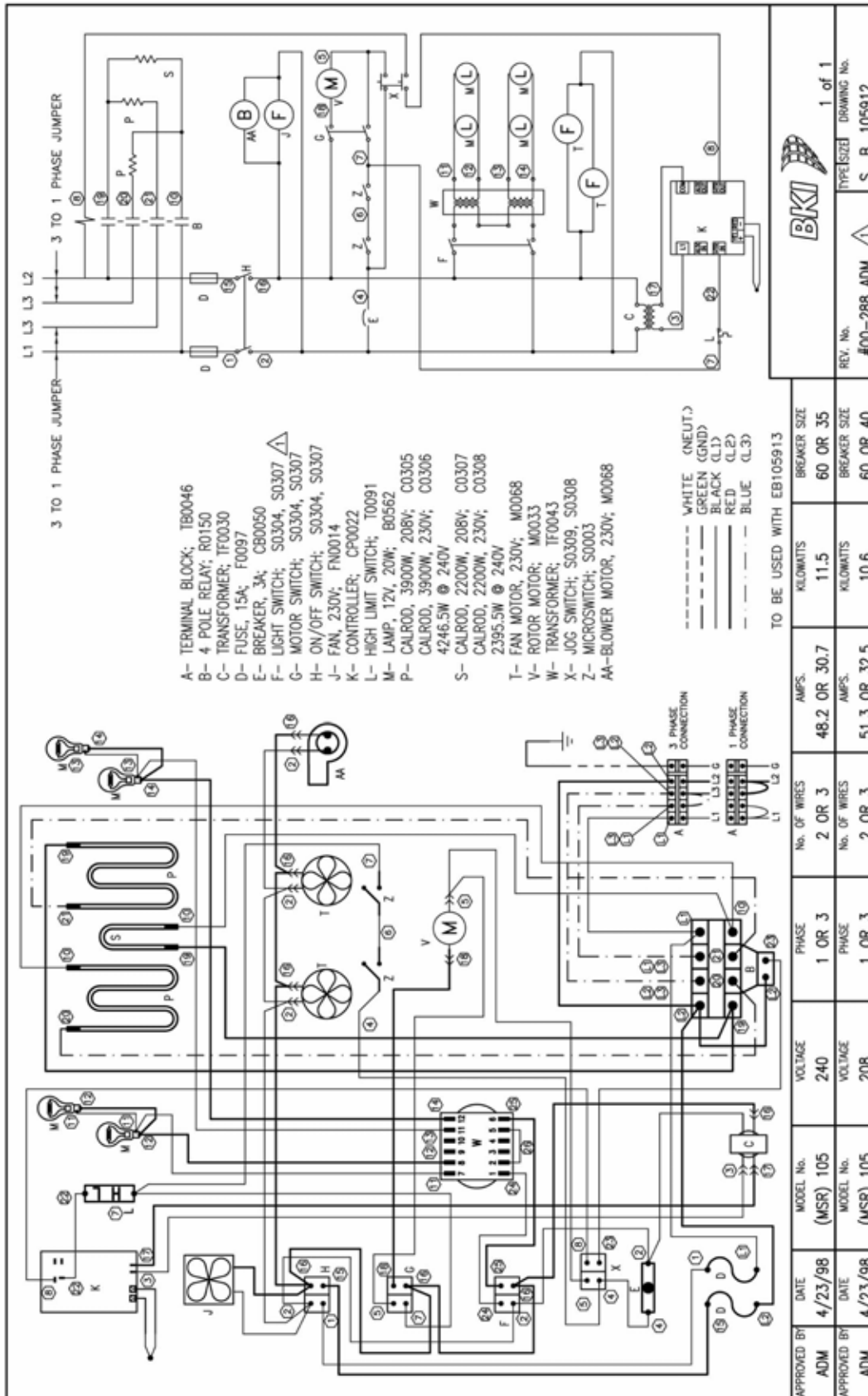

APPROVED BY:	ADM	DATE:	4/23/98	MODEL No. (MSR)	105	VOLTAGE:	240	PHASE:	1 OR 3	No. OF WIRES:	2 OR 3	AMPS:	48.2 OR 30.7	KILOWATTS:	11.5	BREAKER SIZE:	60 OR 35
APPROVED BY:	ADM	DATE:	4/23/98	MODEL No. (MSR)	105	VOLTAGE:	208	PHASE:	1 OR 3	No. OF WIRES:	2 OR 3	AMPS:	51.3 OR 32.5	KILOWATTS:	10.6	BREAKER SIZE:	60 OR 40
1 of 1 TYPESIZED DRAWING No. #00-288 ADM S, B, 105912																	

Notes



P.O. Box 80400, Simpsonville, S.C. 29680-0400, USA
<http://www.bkideas.com>

Made and printed in the U.S.A
LI0174/0905