



User manual

Invoq Combi & Invoq Hybrid

6-1/1 GN

10-1/1 GN

20-1/1 GN

6-2/1 GN

10-2/1 GN

20-2/1 GN

Gas & electric

EN - English

FOR YOUR SAFETY

Do not store or use gasoline or other flammable vapours and liquids in the vicinity of this or any other appliance.

NOTICE

In order to be able to service this appliance, it must be installed with the casters supplied, a connector complying with ANSI Z21.69 - CSA 6.16 and a quick-disconnect device complying with ANSI Z21.41 - CSA 6.9. It must also be installed with restraining means to guard against the transmission of strain to the connector as specified in the appliance manufacturer's instructions.

**WARNING**

Improper installation, adjustment, alteration, service or maintenance can cause property damage, injury or death. Read the user manual, installation manual and service manual thoroughly before installing or servicing this equipment.

**WARNING**

Electrical grounding instructions
This appliance is equipped with a three-prong (grounding) plug for your protection against shock hazard and should be plugged directly into a properly grounded three-prong receptacle. Do not cut or remove the grounding prong from this plug.

Table of contents

Introduction	8
General information	10
Target group	10
Technical changes	10
More documentation	10
Warranty	10
Permissions	10
Screen dumps	10
Symbols used in this document	11
Icons used in the user interface	12
Safety information	17
General safety instructions	17
Safety instructions before use	17
Safety instructions during use	18
Safety instructions for gas ovens	19
Personal protective equipment	19
Product introduction	20
Product description	20
Applications	20

Control functions	21
Main menu	21
Manual menu	21
Recipes menu	22
CareCycle menu.....	22
SmartChef menu.....	22
More menu.....	23
Settings menu.....	23

Operating the oven	24
Using the SmartTouch display	24
Using the fault log function	25
Using the Manual menu	26
Setting the oven temperature.....	26
Setting the time interval	26
Setting the fan speed.....	29
Setting the exhaust function.....	29
Setting the steam injection time	30
Setting the core probe temperature.....	31
Using the convection function.....	32
Recommended convection settings.....	32
Using the steaming function	33
Using the combi function.....	34
Automatic preheating the oven.....	37
Automatic cooling down the oven.....	37
Using the Recipes menu.....	38
Creating a recipe	38
Using a recipe	41
Editing a recipe.....	41
Adding an existing recipe to Favourites.....	41
Duplicating a recipe.....	42
Deleting a recipe.....	42
Setting QSR position.....	43
Using the USB function	45

Using the SmartChef menu	51
Cooking modes for meat	51
Using the CareCycle menu	52
Starting a CareCycle wash	52
Descaling the oven cavity	53
Descaling the steam generator	54
Using the More menu	55
Preheating the oven	55
Cooling down the oven	56
Using the proving function	57
Using MenuPlanner	58
Using the Startup timer function	69
Using the Settings menu	71
Changing user	71
Finding the system information	71
Changing the general settings	72
Changing the cooking settings	79
Changing the oven setup	81
Calibrating the oven doors	82
Monitoring logs and statistics	83
Creating a system report	83
Replacing the HydroShield water filter	84
Loading and unloading a roll-in trolley	85
Using the core probe	86
Meats with larger amounts of connective tissue	87
Buffets and displays	87
Cleaning the oven	88
Cleaning the oven exterior	88
Using the hand shower	89
Cleaning the air intake filter	89
Cleaning the drip tray	90
Cleaning the fat separation	90
Regular maintenance and cleaning	91

Technical data	92
Capacity.....	92
Capacity - PassThrough.....	93
Core temperature guidelines for meat.....	94
Core temperature guidelines for fish.....	94
Core temperature guidelines for Delta-T.....	94
Disposing of the oven	95

This page is intentionally left empty.

Introduction

Dear customer,

Congratulations on purchasing your new Invoq oven.

With your new Invoq oven you have the perfect kitchen appliance, where all the latest technologies have been made simple for you to use. The core of our Invoq ovens will always be to cook, bake and steam, however, modern technology has enabled us to optimise these functions and features to help you reach your performance every time. Intelligent sensors are constantly supervising the processes and correcting when needed to help you use and maintain the oven in the best possible way. From cooking to cleaning, the built-in intelligence guides and helps you to organise your menus for optimum workflow – giving you the freedom to focus elsewhere.

This manual contains the information you need to use and maintain your oven. We recommend that you read the manual and familiarise yourself with the functions and features of the oven. This will ensure optimal cooking results and safety. Please make the manual available to all users of the product and retain it for future reference. The latest version of the manual can be downloaded from our website.



General information

Target group

This document is aimed at persons who work in large and commercial kitchens. The oven must only be used by trained personnel.

The oven must not be used or maintained by the following groups of people:

- Persons with reduced, sensory or mental abilities.
- Persons with lack of experience and knowledge of the oven.
- Children.

In certain circumstances, such persons may operate the oven after having completed a special training and if they are assisted by trained and experienced personnel who takes responsibility of their safety.

Technical changes

This document is subject to changes without notice.

More documentation

You find more documentation about the oven at our website. For more information, see the back page.

Warranty

You find more information about our warranty conditions at our website. For more information, see the back page.

Permissions

This manual describes the oven function in superuser mode. If a function is not accessible, make sure that you are logged in as a superuser. For more information about how to change user, see section "Changing user".

Screen dumps

The screen dumps in this manual are based on an Invoq Hybrid 10-1/1 GN oven with core probe.

Symbols used in this document



DANGER

Dangerous situation which will, if not avoided, result in death or serious personal injury.



WARNING

Dangerous situation which may, if not avoided, result in death or serious personal injury.



CAUTION

Dangerous situation which will, if not avoided, result in minor or moderate personal injury.



SIGNAL WORD

Description of the hazard

- Action to avoid the hazard.

IMPORTANT!

If these instructions are not observed, it may result in malfunction or damage to the oven.



Tips and advice that make the work easier.











A red or grey circle with a diagonal bar indicates that an action must not be taken or must be stopped.



A blue or grey circle with a white graphical symbol indicates that an action must be taken.

Icons used in the user interface





Navigation icons

Symbol	Description	Symbol	Description
	Up		Move
	Down		Undo
	Forward		Remove
	Back		Exit





State icons

Symbol	Description	Symbol	Description
	Standby		





Information icons

Symbol	Description	Symbol	Description
	Search		Support
	Help		Detail
	WiFi		





















Menu bar icons

Symbol	Description	Symbol	Description
	Wipe screen		Language
	Wash		Home

Special user icons

Symbol	Description	Symbol	Description
	Activate		MenuPlanner
	Locked		QSR

Manual operation icons

Symbol	Description	Symbol	Description
	Manual		Steam injection
	Steam		Probe
	Convection		Cook & Hold
	Combi		Delta-T
	CombiSense		Cool down
	CombiSpeed		Preheat
	Timer		Proving
	Temperature		RackTimer
	Fan		Continuous timer
	Exhaust closed		More
	Exhaust open		

Settings submenu icons

Symbol	Description	Symbol	Description
	Settings		Configure

SmartChef icons

Symbol	Description	Symbol	Description
	Speed slow		Speed fast



CareCycle icons

Symbol	Description	Symbol	Description
	Turbo wash		Intensive wash
	Eco wash		Descaling cavity
	Eco+ wash		Descaling steam generator
	Light wash		Flush
	Medium wash		Drain







Recipe step icons

Symbol	Description	Symbol	Description
	Load product		Brushing
	Load product and probe		Empty oven
	Insert core probe		Pause
	Stir		Note





Running recipe icons

Symbol	Description	Symbol	Description
	Running		Stop









Recipe done icons

























Symbol	Description	Symbol	Description
	Edit		Import
	Done		Add image
	Duplicate		Delete
	Export		

Recipe structure icons

Symbol	Description	Symbol	Description
	Recent		Group
	Favourite		All recipes

Recipe icons

Symbol	Description	Symbol	Description
	Beef		Nuggets
	Pork		Grilled
	Lamb		Miscellaneous
	Venison		Desserts

Symbol	Description	Symbol	Description
	Poultry		Cake
	Chicken		Cakes
	Chickens		Apple strudel
	Chicken parts		Cupcakes
	Fish		Bread
	Seafood		Breads
	Sausage		Rye bread
	Sausage roll		Potatoes
	Pie		French fries
	Gratin		Rice and pasta
	Loaf		Vegetables
	Ham		Favourite

Safety information



Read this document before using, installing or servicing the product. Installation and operation must comply with local regulations and accepted codes of good practice.



Installation, maintenance and repair must be carried out by qualified installation and service technicians only. Installation and/or service by others than qualified technicians may result in injury to the operator and/or damage to the oven.

General safety instructions



DANGER

Risk of fire or explosion

- Do not store flammable liquids or gases close to the oven.



DANGER

Risk of injury

- Follow the instructions in this manual carefully.
- Make sure this manual is freely available to everyone working with the oven and for later reference.



DANGER

Risk of squeezing

- Never lift the oven from the left-hand side.



Do not remove the baffle plate in front of the fan wheel.

Safety instructions before use



WARNING

Risk of drawing-in or trapping

- Always make sure no humans or animals are unattended in the cavity before starting the oven.

Safety instructions during use



DANGER

Risk of crushing

- Always use the parking brake on roll-in trolleys.



DANGER

Risk of burn injury

- Use the oven with caution when the door is open.



DANGER

Risk of scalding

- Open the door carefully to avoid being hit by steam and warmth.



DANGER

Risk of scalding

- Never spray water into the oven cavity when the oven temperature is above 100°C.



CAUTION

Risk of scalding

- Place trays of hot liquids or products that become liquid during preparation below eye height in the oven.
- Be very careful when removing trays with hot liquids from the oven.



CAUTION

Risk of burn injury

- Do not touch hot surfaces - the temperature of some surfaces may exceed 60°C.



CAUTION

Risk of chemical burns

- Never use the oven during automatic cleaning.



CAUTION

Risk of crushing

- Always close the door with one hand on the handle to avoid crushing your fingers.

**CAUTION****Risk of slipping**

- Be careful when you remove the used HydroShield water filter as it is heavy and filled with water.

Safety instructions for gas ovens

**DANGER****Suffocation and/or explosion due to gas leak**

If you smell gas, do the following:

- Turn off the gas supply immediately.
- Do not use the control panel.
- Avoid open fire and sparks.
- Call the gas supplier using an external phone.
- If the smell of gas penetrates into a room that is difficult to access, immediately call the fire department and notify the gas supplier.
- If the smell of gas is in the basement, ventilate the basement but do not go down into the basement.
- Only authorised technicians must repair damaged gas fittings.

**DANGER****Suffocation and/or explosion due to gas leak**

- Place instructions that must be followed if the user smells gas in a clearly visible location.
- You can obtain this information from your local gas supplier.



Personal protective equipment

**CAUTION****Risk of skin irritation**

- Use personal protective gloves to avoid direct contact with the CareCycle Clean and CareCycle Descale tabs.

Product introduction

Product description

The Invoq Combi and the Invoq Hybrid are the perfect kitchen appliances where all the latest technologies have been made simple for you to use. The Invoq Combi oven combines injection steam, smart sensors, and integrated drain and inlet systems for a full steaming capacity that is fast, efficient and safe.

The steam production and automated cleaning system are controlled to utilise a minimum of energy and water without ever compromising quality results.

The Invoq Hybrid oven offers a combination of an energy-efficient steam generator with an injection steam system. Together with smart sensors and integrated drain and inlet systems the oven delivers fast, efficient and safe high-density steam saturation – perfect for intensive steaming production.

The PassThrough model is the perfect double-doored kitchen appliance. The 2-door design saves time and cuts potential contamination. Further, it functions as a great eyecatcher to provoke impulse purchases.

The roll-in system gives you safe and efficient operation for increased productivity, as well as good ergonomics with a maximum working height of 160 cm.

Applications

The oven must only be used for cooking food commercially, for example in restaurant kitchens, in large and commercial kitchens in institutions as well as in bakeries, convenience stores, service stations and the like.

The oven must only be operated by hands.

The oven must not be used for any other purposes, as it can damage the product and at worst cause harm to people.

No instruments or mechanical tools must be used as it can damage the product and cause unintended behaviour.

The manufacturer assumes no liability for the consequences of unintended use of the oven.

Control functions

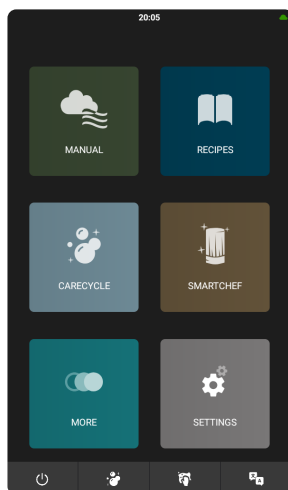

Main menu

From this menu, you have access to the following functions:

- "Manual"
- "Recipes"
- "CareCycle"
- "SmartChef"
- "More"
- "Settings"

The menubar is configurable. However, the standard settings allow you to do the following:

1. Turn the oven on/off.
2. Access the "CareCycle" menu.
3. Wipe the screen without changing any settings.
4. Change language.

For more information about how to configure the menubar, see section "Changing the startup and user profile"

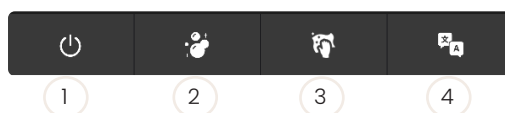

Manual menu

In this menu, you can choose between three cooking modes:

- Steaming.
- Convection.
- CombiSense/CombiSpeed.

From this menu, you can set manual functions such as:

- Oven temperature
- Exhaust
- Preparation time ("Continuous time" and "RackTimer")
- Core temperature
- Fan speed
- Steam injection interval

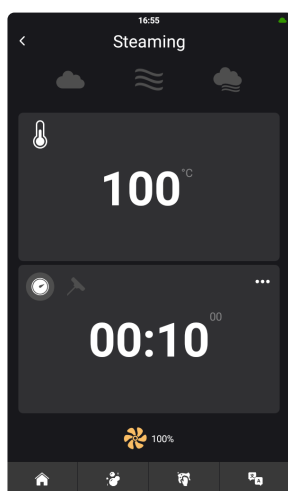

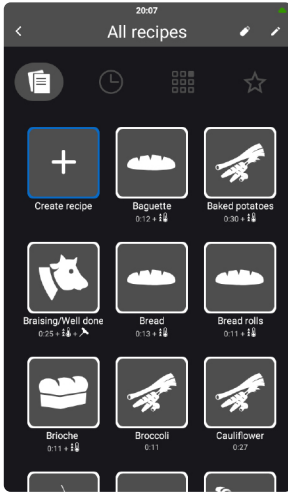

Recipes menu

From this menu, you can do the following:

- Add recipes.
- See favourites.
- See the most recent used recipes.
- See the recipe groups.
- View recipes in alphabetic order.

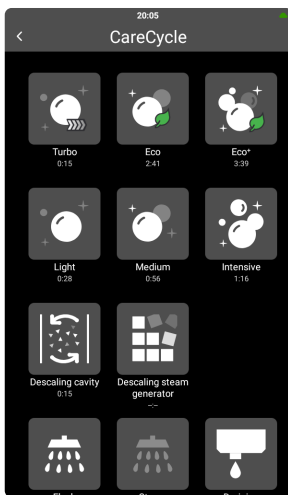

CareCycle menu

From this menu, you have access to the following functions:

- "Turbo"
- "Eco"
- "Eco+"
- "Light"
- "Medium"
- "Intensive"
- "Descaling cavity"
- "Descaling steam generator"
- "Flush"
- "Drain"

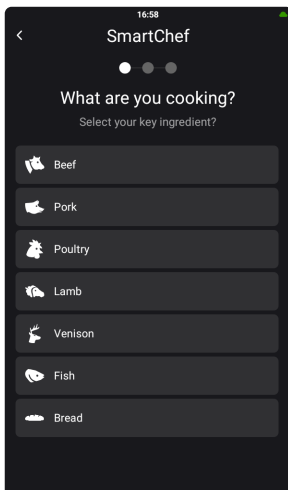

SmartChef menu

From this menu, you can do the following:

- Select key ingredient.
- Select cooking mode.
- Adjust core temperature, colour, mode, size, time and speed depending on the cooking mode.
-



More menu

From this menu, you have access to the following functions:

- "MenuPlanner"
- "Proving"
- "Cool down"
- "Preheat"
- "Startup timer"

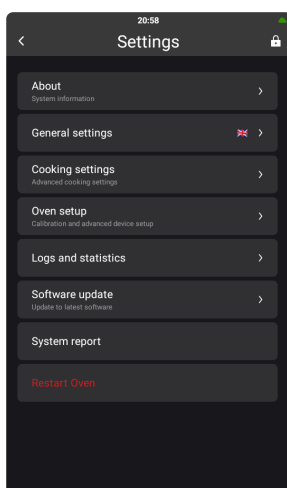

Settings menu

From this menu, you can do the following:

- Change language, time format, date format, sounds, units, cooking settings and oven setup settings.
- Set the time, date, water filter, MenuPlanner, startup, PassThrough, network and cloud service.
- Find information about software version, serial number, IP address, reports, fault log, fault statistics and service counters.
- Turn the screen saver on/off.
- Install software.

Operating the oven

Using the SmartTouch display

The SmartTouch display provides a user friendly and easy way to operate the oven.

1. To select an item, touch the button.
2. To scroll through a list, drag your finger up or down.



Use the wheel, to adjust temperature in 5 degrees intervals.

3. To return to the previous display, touch the arrow icon in the upper left corner.
4. To enter time and temperature using the keypad, touch and hold for two seconds on the display.



Use the keypad, to adjust temperature in 1 degree intervals.

5. Key in the value and touch the blue key.
6. To change the cooking function while the oven is operating, select an alternative cooking function by touching the icon.
7. The "More" function gives you access to the following functions:
 - "Timer"
 - "Continuous time"
 - "RackTimer"
 - "Preheat"
 - "Cool down"

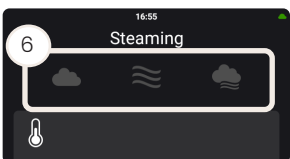
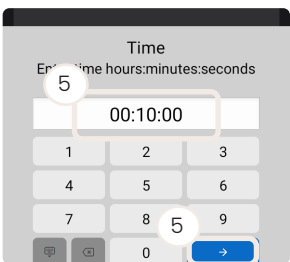
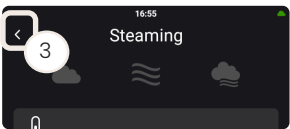
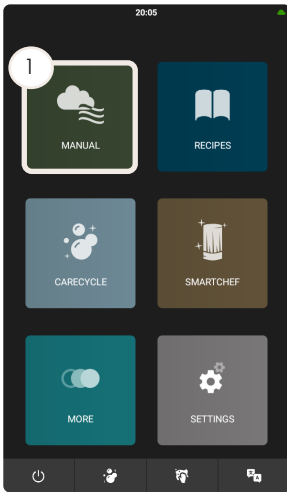

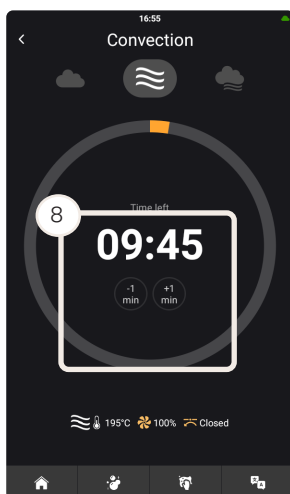

- After 5 seconds, the progress overlay function appears. To go back to the "Manual" overview, press in the middle of the circle. To add or reduce the cooking time with one minute, press "-1" or "+1".

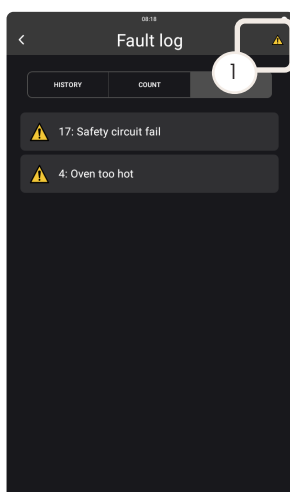

Using the fault log function

This function is only visible in case of active errors. You can always access the fault log function from the "Logs and statistics" menu in the "Settings" menu. The warning icon indicates that there is an active fault, and you can access the fault log function on a running oven.

- Touch the warning icon in the home screen menu.
- Check the error number in the faultfinding manual.
- Follow the guidelines in the faultfinding manual.
- Contact your local service partner, if necessary.

Value	Description
"History"	A chronological overview of the fault logs on the oven.
"Count"	A summary of the faults that have been on the oven.
"Active"	Displays any active faults on the oven.

Table 1

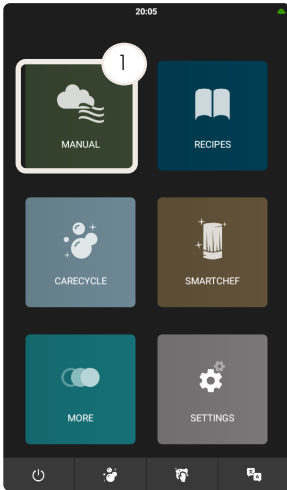

Using the Manual menu

1. Touch "Manual" to enter manual mode.
2. The last used functions and settings are viewed.
3. The oven starts preheating.

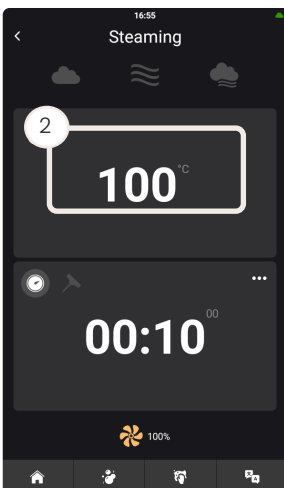

Setting the oven temperature

1. Touch the screen.
2. Drag your finger up or down to select the desired temperature. Or touch and hold for two seconds on the display to use the keypad.

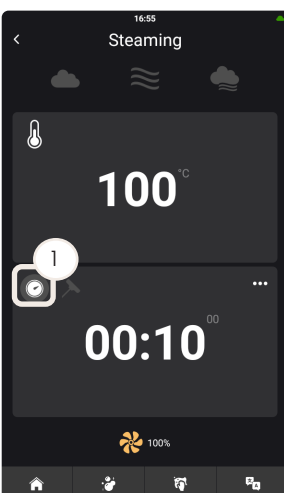

Setting the time interval

1. Select the timer icon.
2. Touch the display.

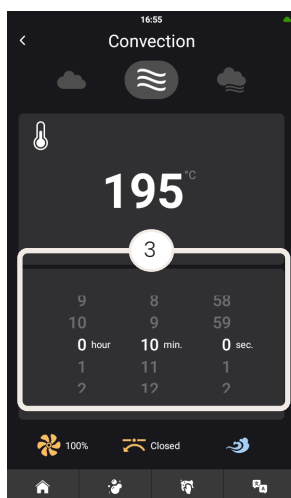

3. Drag your finger up and down to select the hours and minutes from the list. Or touch and hold for two seconds on the display to use the keypad.

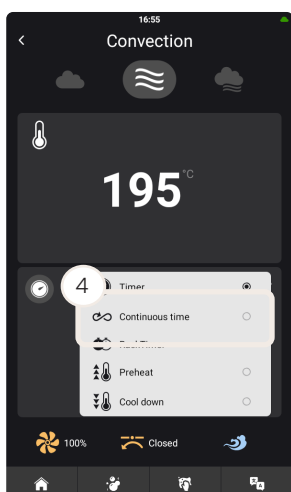

4. If you want to use the "Continuous time" function, touch the more icon and select "Continuous time".
If you want to use the "RackTimer" function, touch the more icon and select "RackTimer".

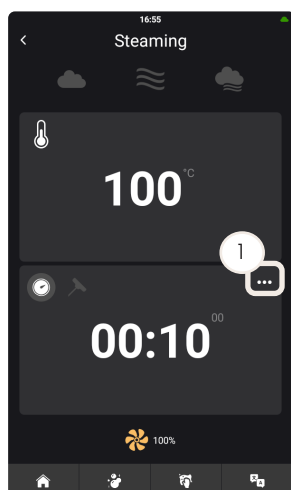

Using the RackTimer function

The RackTimer function enables you to set one timer for each individual rack. In this way, you can cook different products on the same rack or on different racks in the same cooking mode.

The RackTimer function can be used in these cooking modes: "Steaming", "Convection" and "Combi".

1. Touch the more icon in the timer display.
2. Touch "RackTimer" and a new display opens from which you can choose between a number of racks depending on the oven size.

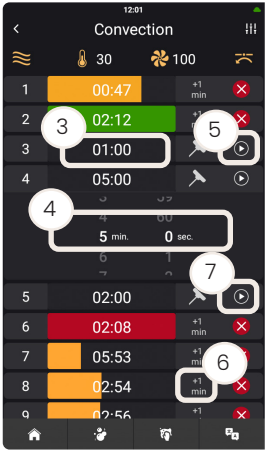

3. Touch the time on the desired rack.



You can use the probe on one of the racks.



You can edit time and temperature in a running recipe.



Opening and closing the door will clear the racks

4. Drag your finger up and down the minute and second wheel to set the time. Or touch and hold for two seconds on the display to use the keypad.



Each rack is set to five minutes. Each rack will remember the previously set time.

- 5. Touch the activate icon next to the time to start cooking.
- 6. Touch "+1 min" to add one minute extra cooking
- 7. Touch the stop icon to stop or reset the timer.

Colour/action	Description
Blue	Cooking.
Yellow	The final minute of cooking time.
Green + alarm	The cooking time is done.
Red	If the timer is not stopped after one minute.
+1	To add an extra minute of cooking time.

Table 2

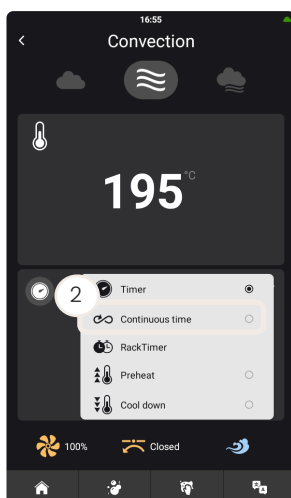

Using the continuous time function

In this function, the oven runs continuously until you stop the oven or change preparation mode.

1. Touch the more icon.
2. Select "Continuous time".

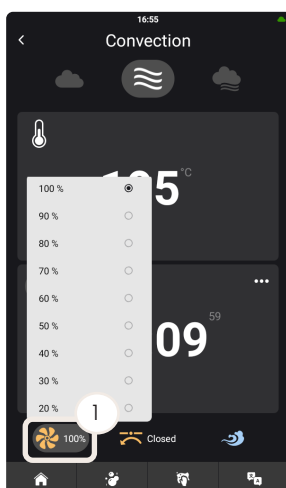

Setting the fan speed

The fan has nine speeds from 20-100%. If the oven temperature is above 200°C, only the fan speeds from 50-100% are available.

You can adjust the fan speed before you start a new process or during a running process.

1. Touch the fan icon.
2. Select the fan speed.



For delicate cooking of products such as puff pastry, cakes and smaller products, use a fan speed between 20-50%.



At low fan speeds, add 1-2 minutes extra cooking time for each 30 minutes.

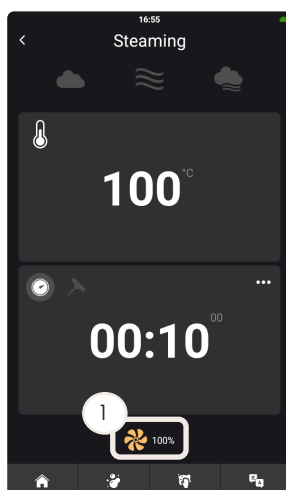

Setting the exhaust function

1. Touch the exhaust icon.
2. Toggle between "Open" and "Closed".



Open the exhaust to crisp up the surface of a product.

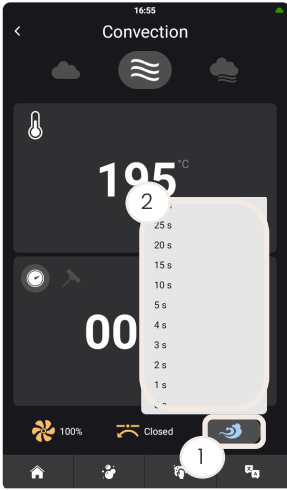

Setting the steam injection time

1. Touch the steam injection icon.
2. Select the desired steam injection time.

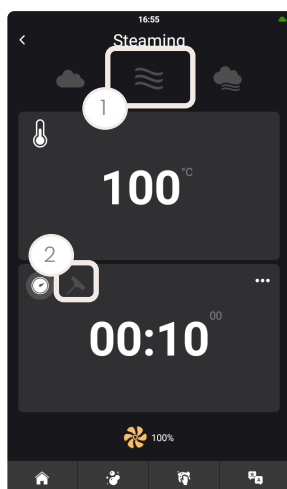

Setting the core probe temperature

1. Select oven function.
2. Touch the core probe icon.
3. Touch the display and drag your finger up or down to select the desired temperature. Or touch and hold for two seconds on the display to use the keypad.
4. Touch the more icon to change the core probe cooking modes.

Core probe cooking mode settings

Cooking mode	Description
"Normal"	Use "Normal" when you want to use the core temperature to determine when the product is finished.
"Delta-T"	Use "Delta-T" to cook to a specific core temperature slowly with low gentle heat. The oven maintains a constant difference in temperature between the core temperature and the oven temperature. The oven temperature rises slowly as the core temperature rises. The default is set at 20°C.
"Cook & Hold"	Use "Cook & Hold" when you want to reach a specific core temperature, keep the food hot once it is done and tenderise the meat. It is also useful for overnight cooking.

Table 3

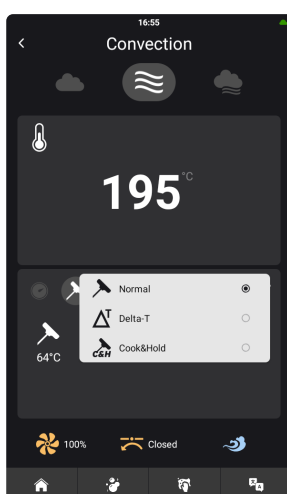
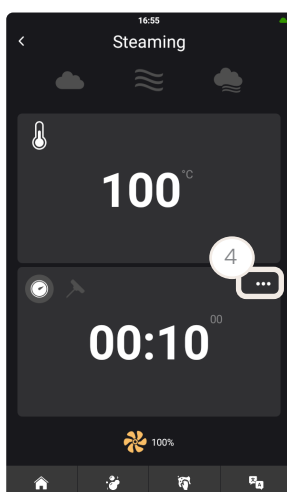

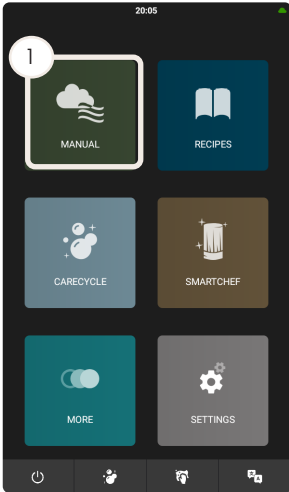

Using the convection function

1. Touch "Manual" in the home screen menu.
2. Touch the convection icon.
3. Set the temperature.
4. Set the timer or the core probe mode.
5. Set the fan speed.
6. Touch the steam injection icon and select a time for steam to be added.
7. Touch the exhaust icon and select it to be either open or closed.



Set the exhaust function to open when baking bread and pastry, roasting pieces of meat or if you want to achieve a grill effect.



Recommended convection settings

Product	Cooking temperature [°C]	Exhaust
Cakes and biscuits	145-175	Closed
Baking	165-185	Open
Grilling	165-185	Open

Table 4



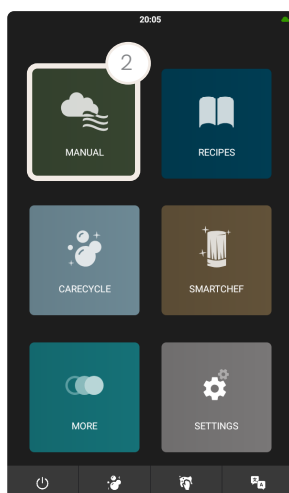

Using the steaming function



For the best result, do not load products until the oven has reached the set temperature.

1. Touch "Manual" in the home screen menu.
2. Touch the steam icon.
3. Set the temperature.
4. Set the timer or the core probe mode.
5. Set the fan speed.



Recommended steaming settings

Temperature level	Steaming temperature [°C]	Product type
Low temperature steaming	65-90	Fish and small vegetables. IMPORTANT! Steam small vegetables at 80°C for 5-10 minutes to keep their colour and crispness.
Traditional steaming	98-100	Meat, pasta, potatoes, rice and root vegetables.
Forced steaming	100-130	Vegetables that require further processing and for faster processing of hard root and frozen vegetables, pasta and rice. IMPORTANT! Be careful when using this function.

Table 5

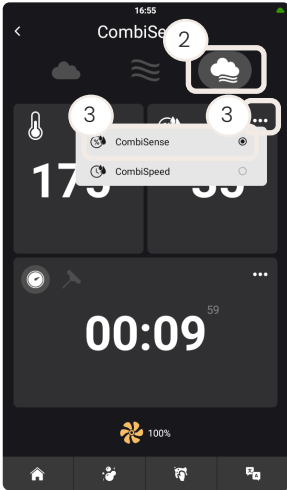

Using the combi function

Setting CombiSense

The CombiSense function allows you to set an oven temperature and add a specific humidity percentage. The function automatically regulates the set percentage of humidity throughout the whole cooking process regardless of type and amount of product being cooked.

The CombiSense function minimises shrinkage and improves the appearance and flavour of the products.

The preferred humidity level is reached after 1-5 minutes depending on the amount of products in the oven.



To achieve the best result, do not load products until the oven has reached the set temperature.

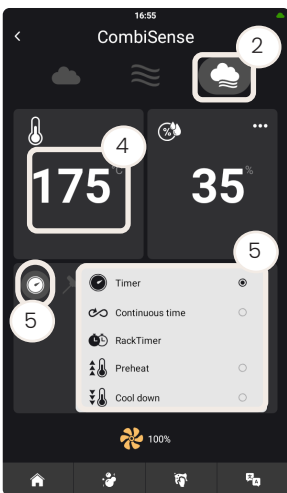

1. Touch "Manual" in the home screen menu.
2. Touch the combi icon.
3. Touch the more icon and select "CombiSense".
4. Set the temperature.
5. Touch the timer icon and set the time.

To change the mode, touch the more icon to select either "Timer", "Continuous time", "RackTimer", "Preheat" or "Cool down".

6. Touch the core probe icon, the oven starts in "Normal" mode.
To change the mode, touch the more icon to select either "Normal", "Delta-T" or "Cook & Hold".

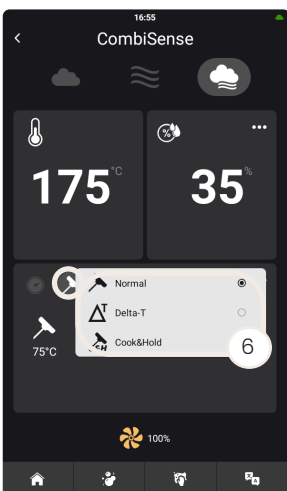

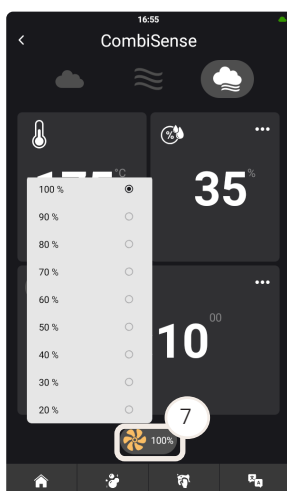

7 Touch the fan icon and set the fan speed.

Recommended humidity levels

Product	Humidity level [%]	Temperature [°C]
Roasting	30-40	170-190
Gravy production during braising of meat	70-80	145-165
Poaching fish, poultry and crispy vegetables	90-100	7-120
Steaming potatoes, rice, pasta, meat, etc.	100	100

Table 7



100°C with 100% humidity can be used as a steaming mode alternative.

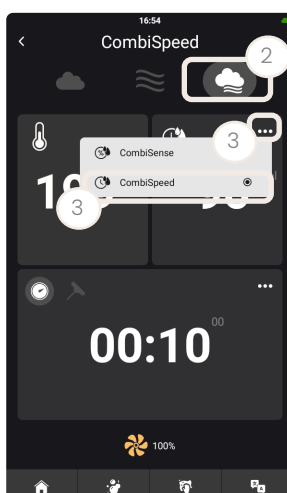

Setting CombiSpeed

The CombiSpeed function allows you to set an oven temperature and select a humidity level. This function is well-suited for braised products and poultry. The CombiSpeed function minimises shrinkage and improves the appearance and flavour of the products. You can choose between ten different humidity levels.



To achieve the best result, do not load products until the oven has reached the set temperature.

1. Touch "Manual" in the home screen menu.
2. Touch the combi icon.
3. Touch the more icon and select "CombiSpeed".
4. Set the temperature.

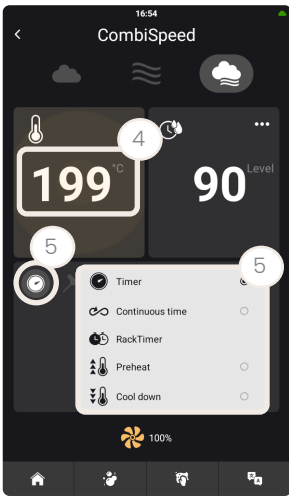

5. Touch the timer icon and set the time.
To change the mode, touch the more icon to select either "Timer", "Continuous time", "RackTimer", "Preheat" or "Cool down".
6. Touch the core probe icon, the oven starts in "Normal" mode.
To change the mode, touch the more icon to select either "Normal", "Delta-T" or "Cook & Hold".
7. Touch the fan icon and set the fan speed.

Recommended humidity levels

Product	Humidity level	Temperature [°C]
Roasting	30-40	170-190
Gravy production during braising of meat	70-80	145-165
Poaching fish, poultry and crispy vegetables	90-100	7-120
Steaming potatoes, rice, pasta, meat, etc.	100	100

Table 6

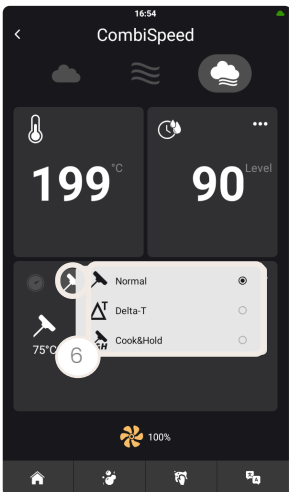

100°C with 100% humidity can be used as a steaming mode alternative.

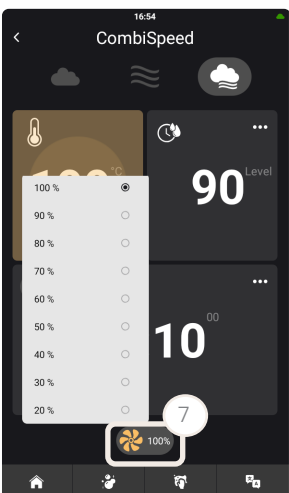

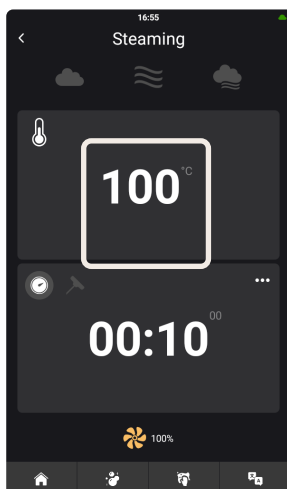

Automatic preheating the oven

The automatic preheat function ensures that the oven chamber is thoroughly heated before starting a cooking process. The function compensates for heat loss during opening and closing the oven, and it ensures consistent end results.



Set the preheating temperature to 10-20% above the desired temperature.



You can adjust the delta settings in the "Settings" menu. See section "Changing the CookTimeCorrection settings".

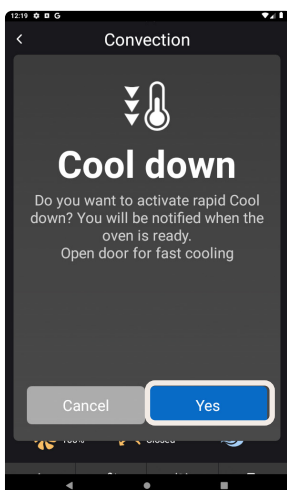

Automatic cooling down the oven

If you change the temperature significantly, for example from 200°C to 80°C, a pop-up menu will appear suggesting opening the oven door or prompt the oven to cool down. An alarm will sound when the temperature is reached.



For the best result, set the cool-down temperature to 20°C lower than the desired temperature of the next cooking function.

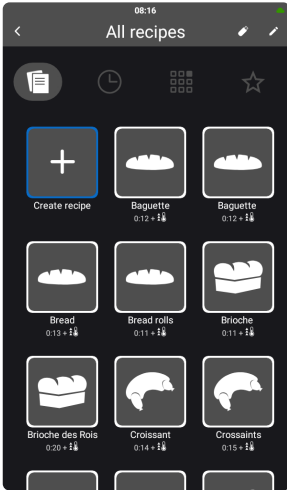

Using the Recipes menu

The oven can hold 1500 recipes. Each recipe can hold up to 15 different steps. A set of preset recipes are installed on the oven from factory.

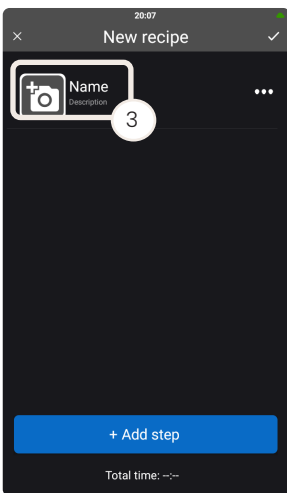

Creating a recipe

Creating the recipe content

1. Touch "Recipes" in the home screen menu.
2. Touch "Create recipe".
3. Touch "Name".
4. Enter the recipe name.
5. Touch the favourite icon to add the recipe to the favourites view.
6. Enter a description, if necessary.
7. Touch the done icon.
8. Touch "Image" if you want to add an image.

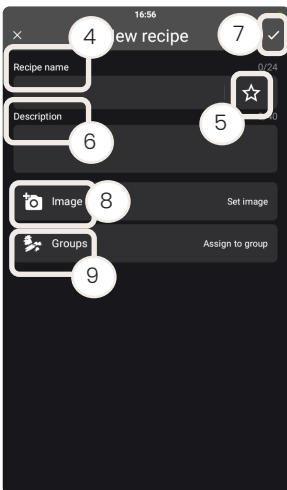



You can choose between a set of pre-installed colour photos and greyscale icons, or you can upload your own images via the USB connection.

For more information, see section "Importing an image via USB".



9. Touch "Groups" if you want to assign the recipe to a group of recipes.
10. Touch "Create group" to create a new group.
11. Enter the group name and touch the done icon.
If you already have a set of groups, select the group to which the recipe belongs.
12. Touch the done icon to save the recipe.

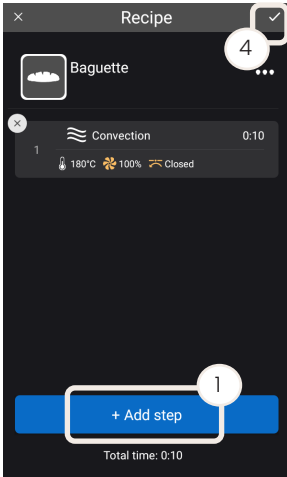

Creating the recipe step

After you have created the recipe and added the recipe details, do the following:

1. Touch "+ Add step".
2. Select the steps needed in the recipe.
3. Continue to add steps until you have created the recipe.



To ensure consistent cooking results, use "Preheat" as the first step and then "Note" as the next step to allocate time for inserting the product in the oven.



Use a "Note" step at any stage in the recipe program to create an alarm or to convey information to the user.



After preheating, the oven will maintain the temperature for ten minutes whilst you load the products.

4. Touch the done icon.

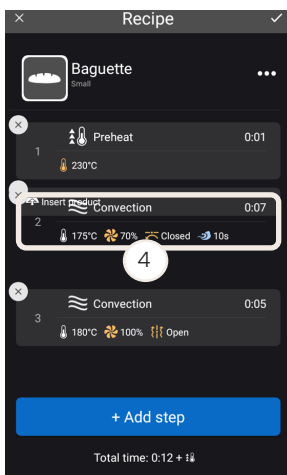

Moving a recipe step

You can change the order of the steps in a recipe.

1. Touch "Recipes" in the home screen menu.
2. Select the recipe you want to change.
3. Touch the edit icon.
4. Press down and hold the step you want to move.
5. Move the step to the desired position.

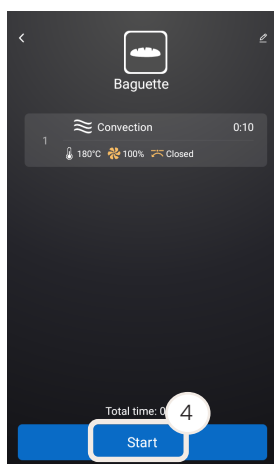

Using a recipe

1. Touch "Recipes" in the home screen menu.
2. Touch the desired recipe.



An overview of the recipe details is displayed.

3. Touch "Start".

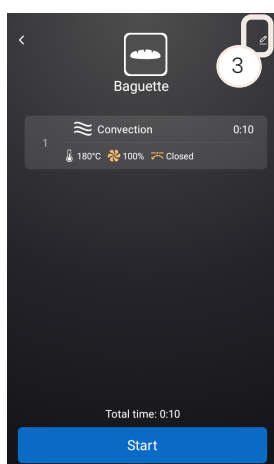

Editing a recipe

1. Touch "Recipes" in the home screen menu.
2. Touch the desired recipe.
3. Touch the edit icon.
4. Make the necessary changes.
5. Touch the done icon.

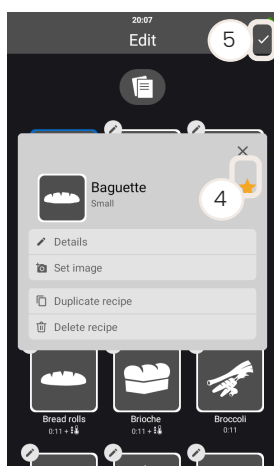

Adding an existing recipe to Favourites

1. Touch "Recipes" in the home screen menu.
2. Touch the edit icon.
3. Touch the desired recipe.
4. Touch the favourite icon.
5. Touch the done icon.

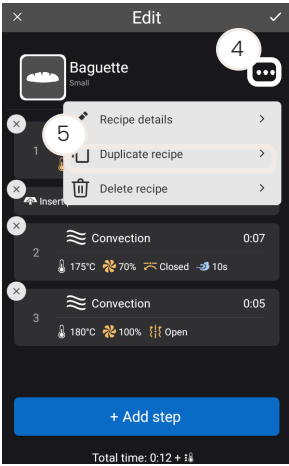

Duplicating a recipe

This feature is an easy way to create specific recipes with a similar content.

1. Touch "Recipe" in the home screen menu.
2. Select the recipe you want to duplicate.
3. Touch the edit icon.
4. Touch the more icon.
5. Touch "Duplicate recipe".



You have a couple of seconds to undo your choice.

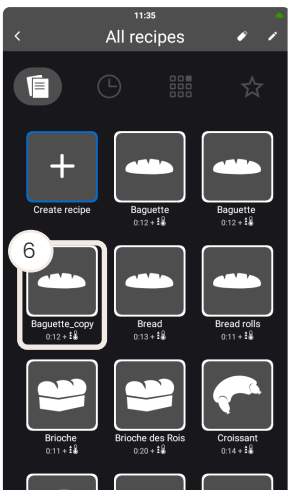

6. The recipe is duplicated and named "Recipe name_copy".
7. Change the name of the recipe.
8. Save the new recipe.

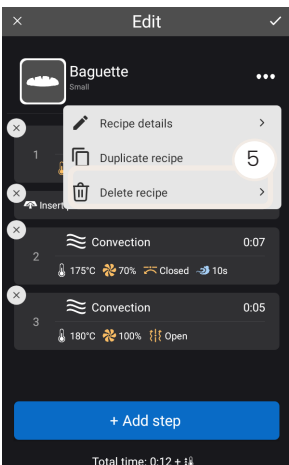

Deleting a recipe

1. Touch "Recipe" in the home screen menu.
2. Select the recipe you want to delete.
3. Touch the edit icon.
4. Touch the more icon.
5. Touch "Delete recipe".



You have a couple of seconds to undo your choice (6).

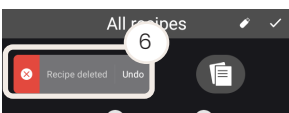

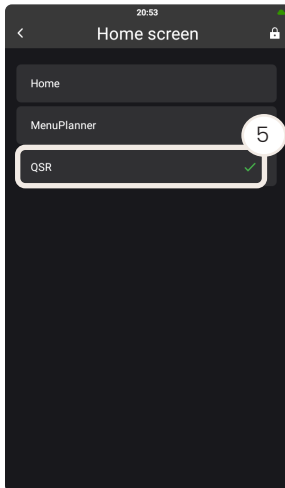

Setting QSR position

Changing the startup profile to "QSR"

1. Make sure you are logged in as superuser.
2. Touch "Settings" in the home screen menu.
3. Touch "General settings".
4. Touch "Startup and user profile".
5. Touch "Home screen".
6. Touch "QSR".



Naming of headlines on page

1. Set the startup profile to "QSR". See section "Changing the startup profile to "QSR"".
2. Touch "Edit".
3. Double-click on "QSR headline"
4. Enter the name of the page.
5. Touch "Done".

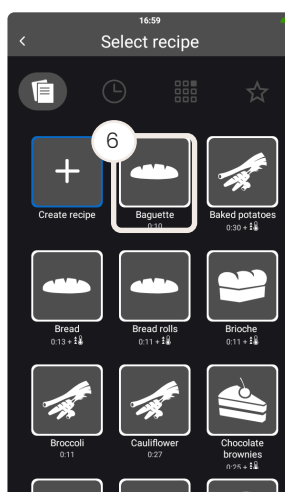

6. Touch "+" and add the relevant recipes.
7. Touch "Done".



Locking the home screen

You can lock the user permissions so that the user cannot edit the recipes and will have limited access to settings.

1. Touch "Settings" in the home screen menu.
2. Touch the locked icon and make sure the oven is set to "Superuser".
3. Touch "OK".
4. Touch "General settings".

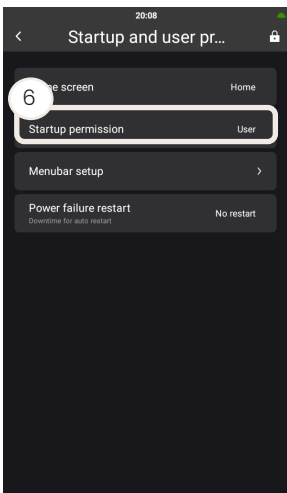

5. Touch "Startup and user profile".
6. Touch "Startup permission".
7. Select "User".
8. Restart the oven.

To unlock the home screen, see "Changing user".

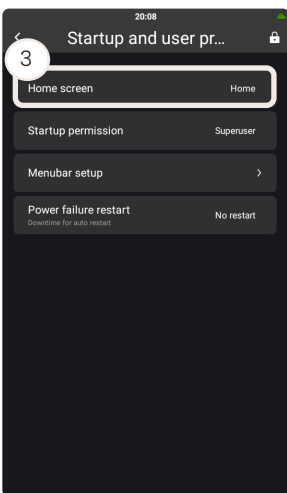

Disabling the QSR function

1. Change the user settings to "Superuser". See section "Changing user".
2. Change the startup profile to "Home" or one of the other settings. See section "Changing the startup profile to "QSR"".

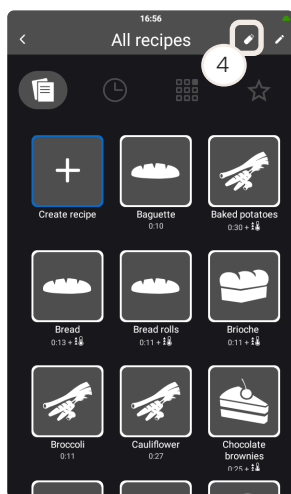

Using the USB function

The USB port (A) is placed on the right-hand side of the oven. You can export and import settings, images, MenuPlanner recipes and recipes via the USB port and then transfer them to another Invoq oven. You can also import recipes from TOUCH-model ovens that have been produced from september 2012 to October 2022.

Importing a recipe

1. Remove the protective silicone plug from the USB port.
2. Insert a USB stick
3. Touch "Recipes" in the home screen menu.
4. Touch the USB icon.
5. Touch "Import recipes".
6. Touch the .zip file you want to import.

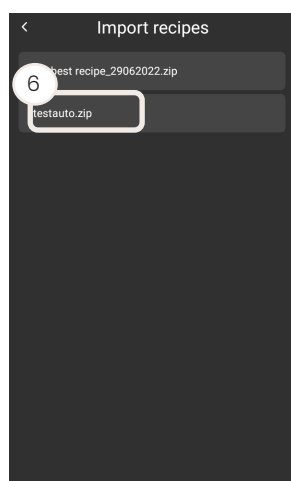
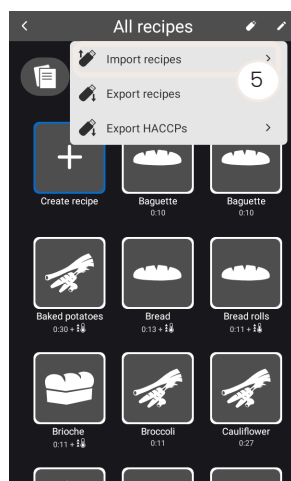

7. Select the recipes and/or QSR headlines you want to import.

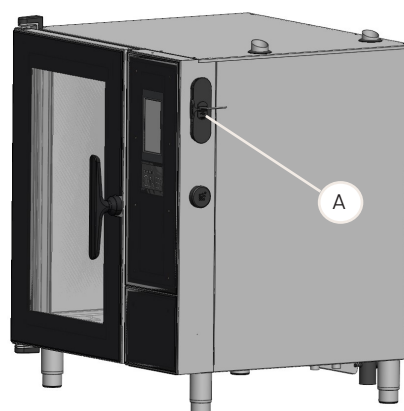

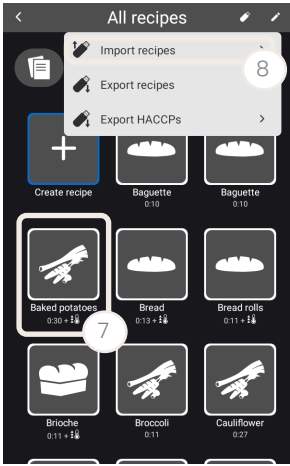

8. Touch "Import recipes" to import the selected recipes.
9. Check the box for the items you want to remove.

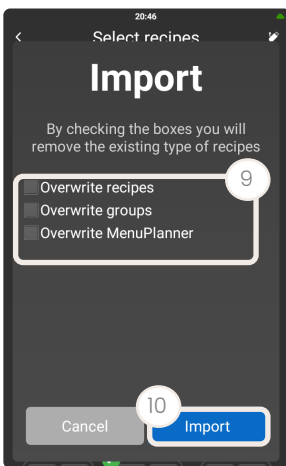

10. Touch "Import".
11. Touch "Yes" to confirm your selection of what to import.

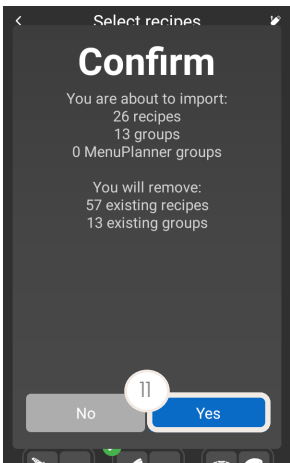

12. Remove the USB stick.
13. Reinsert the protective silicone plug.

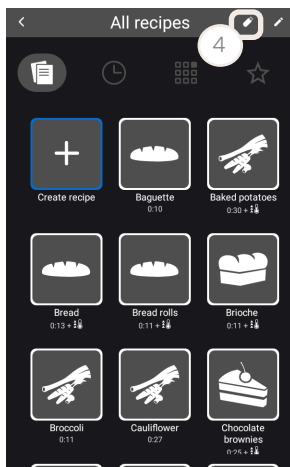

Exporting a recipe

1. Remove the protective silicone plug from the USB port.
2. Insert a USB stick.
3. Touch "Recipes" in the home screen menu.
4. Touch USB icon.

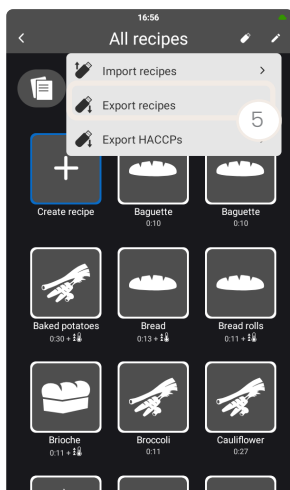

5. Touch "Export recipes".

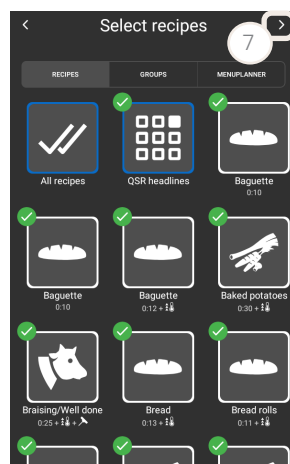

6. Select the recipes and/or QSR headlines that you want to export.
7. Touch the right icon.



8. Enter the recipe file name.



We recommend that you name and date the file for easier navigation.

9. Touch the done icon.

10. Touch "Finish".

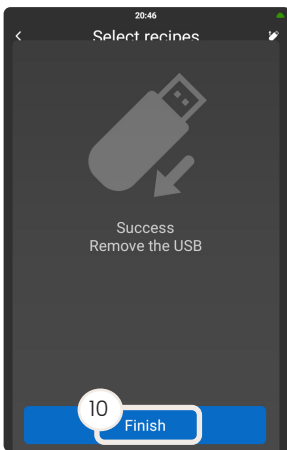

11. Remove the USB stick.

12. Reinsert the protective silicone plug.

IMPORTANT!

You can only upload files from a USB stick if the files are stored in a folder named "Recipes".



The oven will automatically create a folder on the USB stick named "Recipes". The downloaded recipe file will be stored in the folder as a .txt file containing recipes with standard icons or .zip files containing recipes and images.

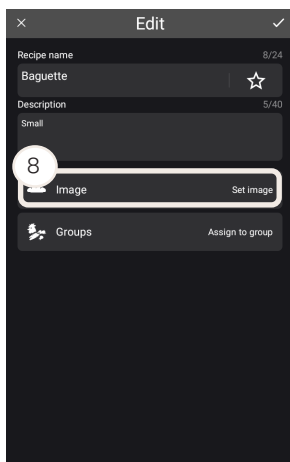

Importing an image via USB

1. Remove the protect silicone plug from the USB port.
2. Insert a USB stick.
3. Touch "Recipes" in the home screen menu.
4. Touch the recipe to which you want to add the image.
5. Touch the edit icon.
6. Touch the more icon.
7. Touch "Recipe details".
8. Touch "Set image".
9. Touch "USB stick" and select the relevant image.

Make sure that the images are saved in the "Invoq\ CustomImages" folder on the USB stick.

IMPORTANT!

For more information about how to set the correct folder structure on the USB stick, see section "Verifying the USB stick" in the service manual.

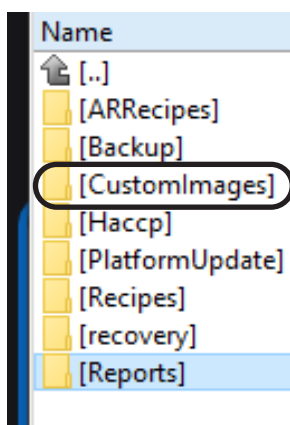
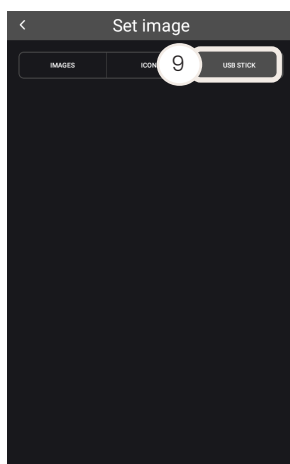

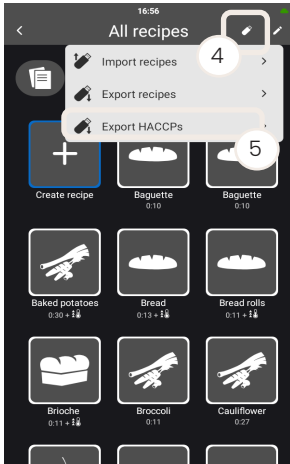

Using the HACCP function

The oven automatically records HACCP files each time a recipe, SmartChef or CareCycle program is completed. These files are stored for 60 days and are available for download directly in PDF format.

1. Remove the protective silicone plug from the USB port.
2. Insert a USB stick.
3. Touch "Recipe" in the home screen menu.
4. Touch the USB icon.
5. Touch "Export HACCPs".
6. Select a "From" and "To" date.
7. Touch the download icon in the upper right corner.
8. Touch "Finish".
9. Remove the USB stick.
10. Reinsert the protective silicone plug.

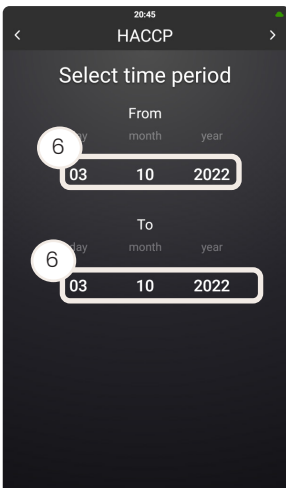

The oven automatically creates a folder on the USB stick named "ONE". In the "ONE" folder there is an "HACCP" folder in which the downloaded files are stored.

The HACCP files contain a graph showing the set and actual temperature for the oven cabinet and core probe. Temperatures are recorded every minute.

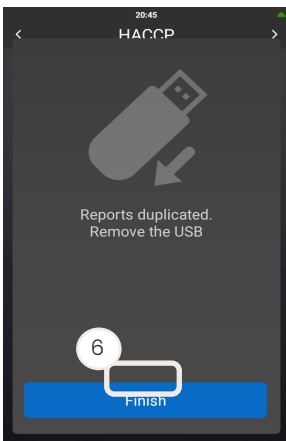

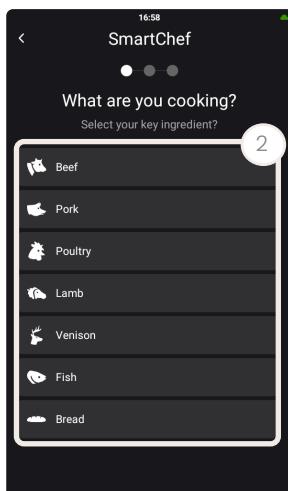

Using the SmartChef menu

Use SmartChef for automatic cooking. This function provides a number of preset cooking function for a variety of products.

1. Touch "SmartChef" in the home screen window.
2. Touch the product type you want to cook.
3. Touch the cooking mode you want to use.
4. Adjust core temperature, colour, mode, size and speed, if necessary.
5. Touch the list icon to see the recipe.
6. Touch "Start".



The oven starts preheating and sounds an alarm when ready.

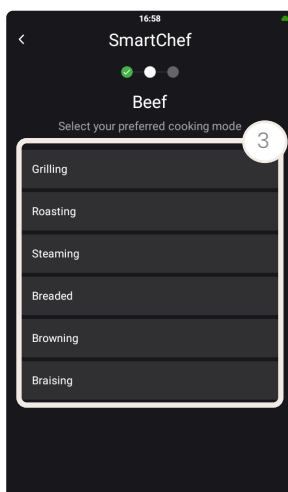

7. Insert the core probe, if necessary and prompted.
8. Press "Confirm" after loading.

When SmartChef has finished cooking, you will be prompted to save the recipe as a favourite.

Cooking modes for meat

Product	Beef	Pork	Poultry	Lamb	Venison	Fish
"Grilling"	X	X	X	X	X	X
"Roasting"	X	X	X	X	X	X
"Steaming"	X	X	X	X	X	X
"Breaded"	X	X	X	X	X	X
"Browning"	X	X	X	X	X	
"Braised"	X	X	X	X	X	
"Crispy skin"		X				

Table 8

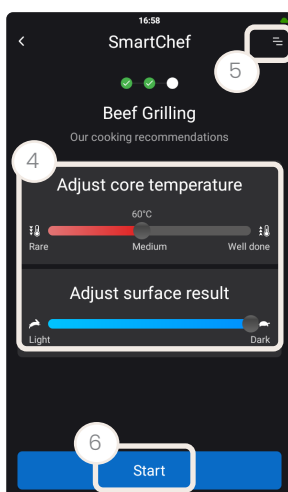

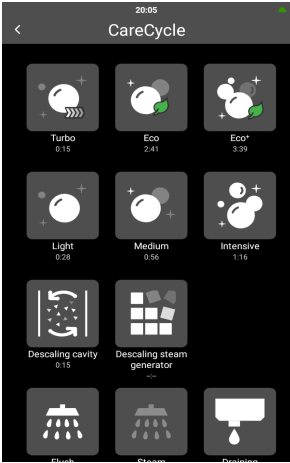

Using the CareCycle menu



CAUTION

Risk of skin irritation

- Use personal protective gloves to avoid direct contact with the CareCycle Clean and CareCycle Descale tabs.



CAUTION

Risk of chemical burns

- Never use the oven during automatic cleaning.

Starting a CareCycle wash

1. Touch "CareCycle" in the home screen menu.
2. Select the type of wash you want use.
3. Make sure the oven is empty and touch "Yes".

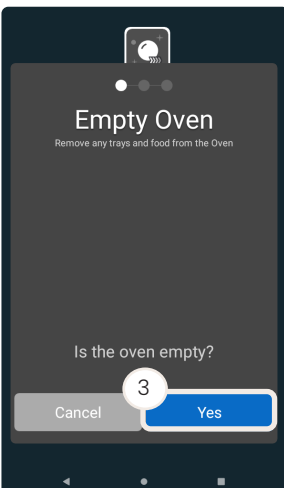

IMPORTANT!

Do not open the door during wash to avoid disrupting the wash cycle.

4. Place the number of CareCycle Clean tabs required for the specific wash cycle into the strainer.
5. Touch "Yes".
6. The wash cycle starts.

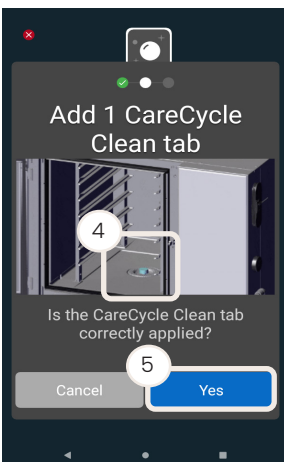

If the cleaning cycle is interrupted due to e.g. power cut, the oven will start an automatic rinse immediately after being switched on to ensure that no chemical residues are left in the oven cavity.

Types of wash cycles

Wash	Description	Time [HH:MM)
"Turbo"	Fast cleaning cycle for washdown between cookings.	00:15
"Eco"	Greener version of the medium wash.	02:41
"Eco+"	Greener version of the intensive wash	03:39
"Light"	Suitable for a lightly soiled oven.	00:28
"Medium"	Suitable for a moderately soiled oven.	00:56
"Intensive"	Suitable for a heavily soiled oven.	01:16
"Descaling cavity"	Removes limescale in the oven cavity and drain	00:15
"Descaling steam generator"	Removes limescale in the steam generator	–*
"Flush"	A short wash with no chemicals.	00:15
"Drain"	Empties the oven cavity and drain	00:01

Table 9

*Only relevant on Invoq Hybrid ovens. The time depends on the amount of limescale in the steam generator.

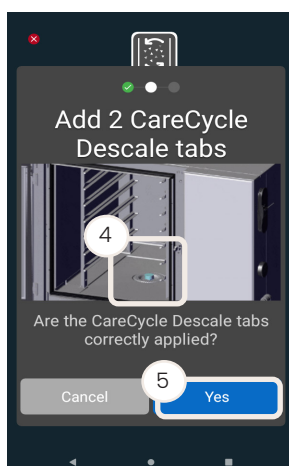

Descaling the oven cavity

1. Touch "CareCycle in the home screen menu.
2. Touch "Descaling cavity".
3. Make sure the oven is empty and touch "Yes".
4. Place the number of CareCycle Descal tabs required into the strainer.
5. Touch "Yes".
6. The descaling of the oven starts

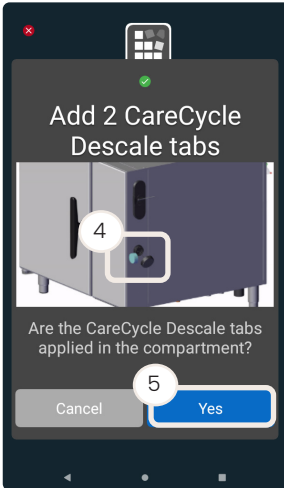

Descaling the steam generator

Only relevant for Invoq Hybrid ovens.

1. Touch "CareCycle" in the home screen menu.
2. Touch "Descaling steam generator".
3. Make sure the oven is empty and touch "Yes".
4. Place the number of CareCycle Descal tabs required in the compartment.
5. Touch "Yes".
6. The descaling of the steam generator starts.



Using the More menu

Preheating the oven

1. Touch "More" in the home screen menu.
2. Touch "Preheat".
3. Touch the temperature display.
4. Drag your finger up and down the temperature wheel to set the temperature.
5. The oven starts preheating and you can follow the progress in the lower left-hand corner of the display.
6. Touch "Exit" when the oven has reached the selected temperature.



If you use "Preheat" as a step in your recipes, we recommend that you set a time of 1-2 minutes to achieve the best preheat condition. Push "Wait while preheating" (7) and set the time.

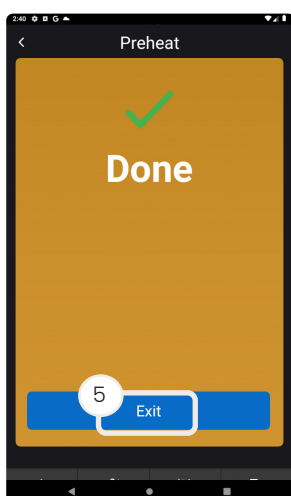
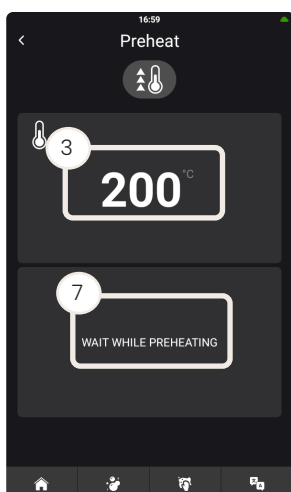



Cooling down the oven

Use the cool-down function if you want to cool down the oven chamber e.g. when changing from one cooking function to another.

1. Touch "More" in the home screen menu.
2. Touch "Cool down".
3. Touch the temperature display.
4. Drag your finger up and down the temperature wheel to set the temperature. Or touch and hold for two seconds on the display to use the keypad.



Open the door for faster cooling.

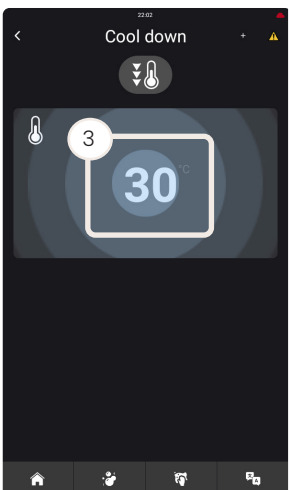

5. Touch "Exit" to finish cool down.

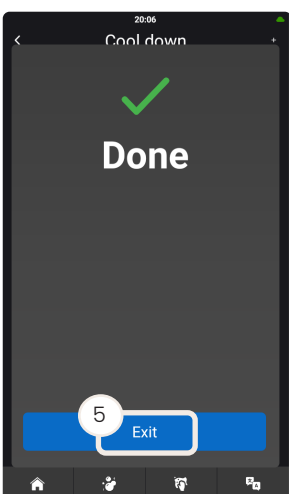



Using the proving function

Use the proving function for products that need proving before baking. Cool down the oven before proving.



Pre-baked products do not need proving. Pre-proved products require defrosting and baking.

1. Touch "More" in the home screen menu.
2. Touch "Proving".
3. Set the temperature and the timer.
4. If you want to change the fan speed, touch the fan icon and set the fan speed.
5. The oven starts the proving function, and you can follow the progress on the display.
6. Touch "Exit".

Recommended proving settings

Product	Temperature [°C]	Minutes [min]	Fan speed [%]
Loaves of 400-800 g	32	45	30-50
Rolls of 60-200 g	36	25	30-50
Baguettes of 60-200 g	36	25	30-50

Table 10

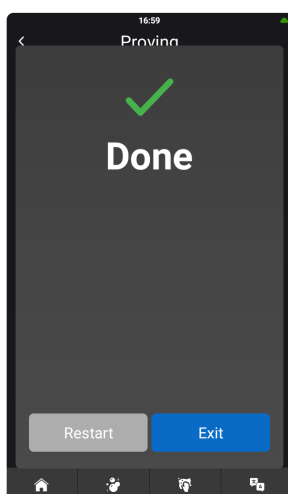
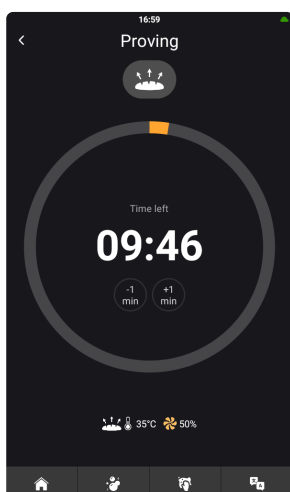
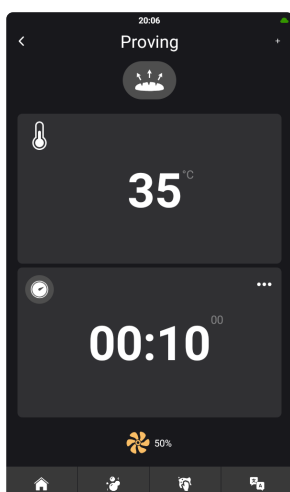

To ensure an optimal proving environment, we recommend a maximum fan speed of 50%.

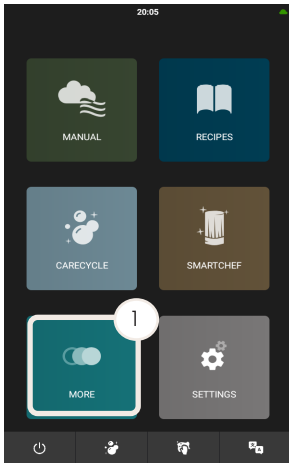

Using MenuPlanner

The MenuPlanner function allows you to cook many different items at the same time. The integrated timers automatically notify you when to load and unload dishes from the oven ensuring precise and on time efficiency in the kitchen.

Before you start using MenuPlanner, make sure to have created menus which are compatible - menus that consist of recipes with the following characteristics:

- The recipes have the same cooking function such as convection heat and the same cooking parameters such as temperature and time.
- The recipes only include one step.
- The temperature in the recipes can fluctuate 10°C above or below the set temperature of the first chosen recipe in a menu.



MenuPlanner is available in these cooking modes: "Steaming", "Convection" and "Combi".

Accessing MenuPlanner

1. Touch "More" in the home screen menu.
2. Touch "MenuPlanner".

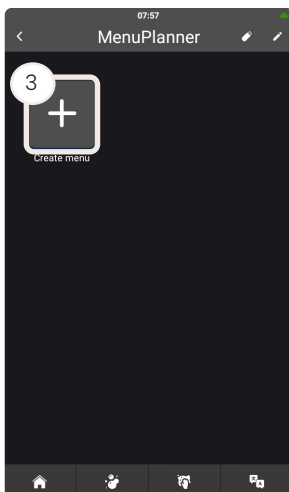

Creating a menu

1. Touch "More" in the home screen menu.
2. Touch "MenuPlanner".
3. Touch "Create menu".

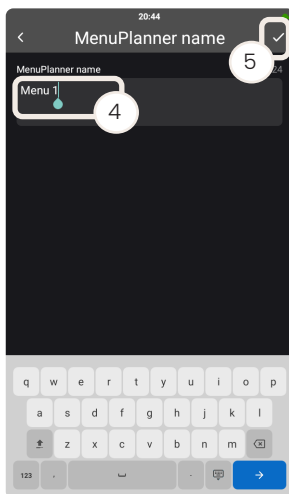

4. Touch "MenuPlanner name" and enter the name of the menu.



The maximum length of the name is 24 characters to ensure optimised user experience.

5. Touch the done icon.



6. Touch the more icon and you can choose between:
 - MenuPlanner details
 - Duplicate
 - Delete
7. Select a function and touch the done icon.



The menus are displayed in alphabetic order.

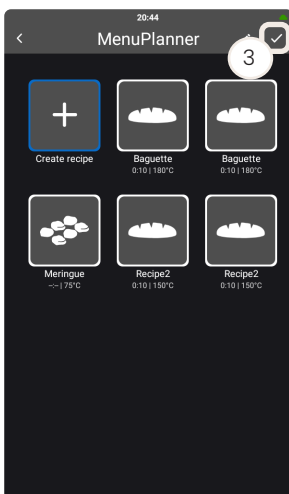

Editing a menu

1. Touch "More" in the home screen menu.
2. Touch "MenuPlanner".
3. Touch the edit icon.

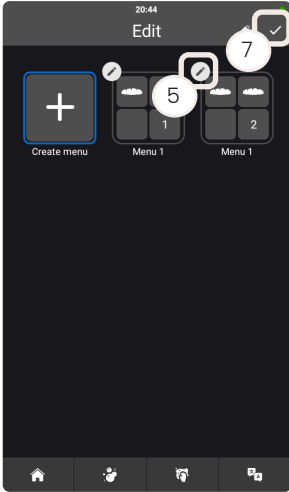

4. Touch the edit icon on the menu you want to edit.
5. Touch "Edit".
6. Make the necessary changes.
7. Touch the done icon.

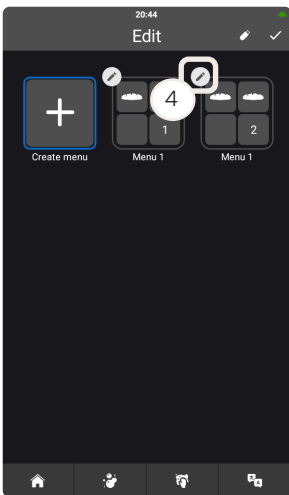

Duplicating a menu

1. Touch "More" in the home screen menu.
2. Touch "MenuPlanner".
3. Touch the edit icon.
4. Touch the edit icon on the menu you want to edit.

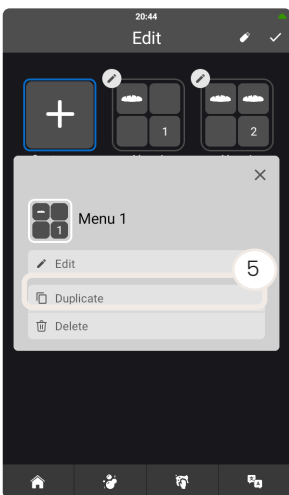

5. Touch "Duplicate".



6. The menu is duplicated and named "Menu name_copy".
7. Touch the edit icon on the duplicated menu.
8. Touch "Edit".
9. Touch the name and change the name of the menu.
10. Touch the done icon.

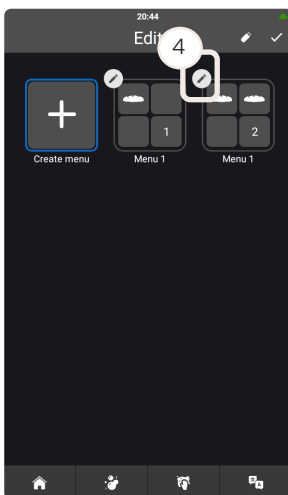

Deleting a menu

1. Touch "More" in the home screen menu.
2. Touch "MenuPlanner".
3. Touch the edit icon.
4. Touch the edit icon on the menu you want to delete.

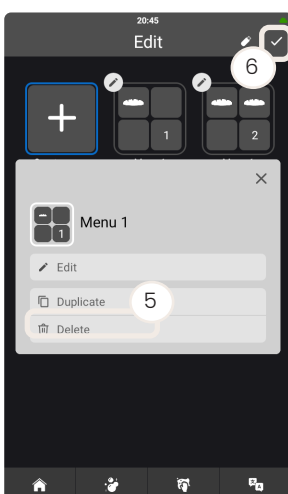

5. Touch "Delete".
6. Touch the done icon.

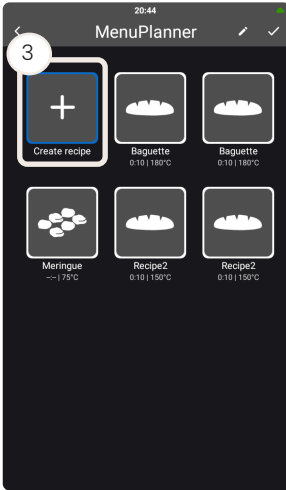

Creating a one-step recipe for MenuPlanner

1. Touch "More" in the home screen menu.
2. Touch "MenuPlanner".
3. Touch "Create menu" if you want to create a new menu with one-step recipes, or touch an existing menu to which you want to add a new one-step recipe.

For more information about creating a menu, see "Creating a menu".

4. Touch "+Add recipe".

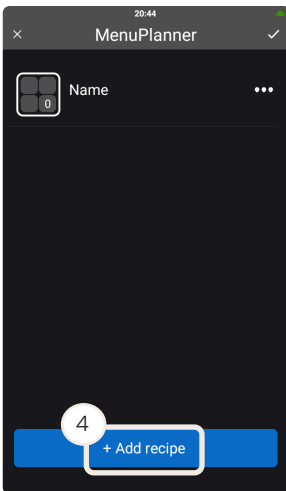

5. Touch "Create recipe".

For more information about editing an existing recipe, see "Editing a recipe".

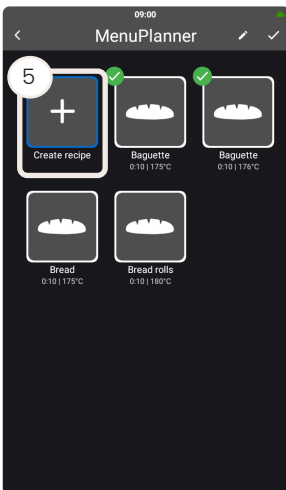

6. Touch "Name" and enter the name of the recipe.

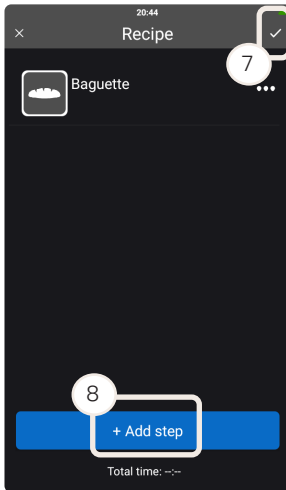

You can also add a description or an image.

7. Touch the done icon.
8. Touch "+Add step".

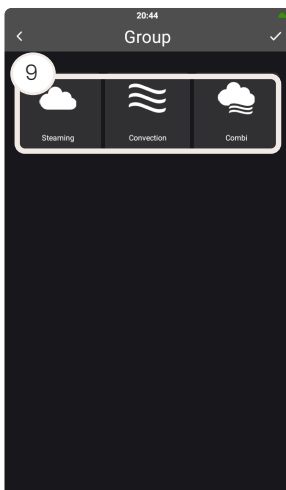

9. Touch the cooking mode - "Steaming", "Convection" or "Combi".

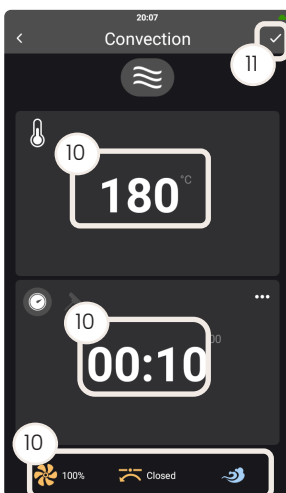

10. Select the cooking parameters such as temperature, time and fan speed.
11. Touch the done icon.

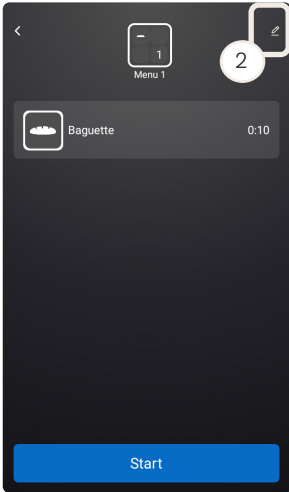

Allocating a recipe to a menu

1. Select the menu to which you want to add a recipe.
2. Touch the edit icon.

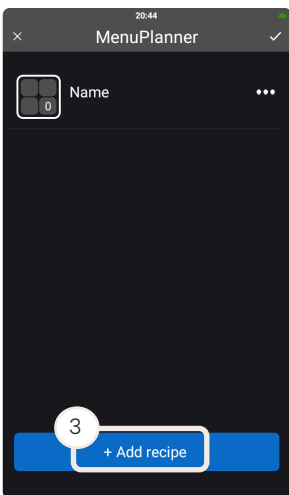

3. Touch "+Add recipe".

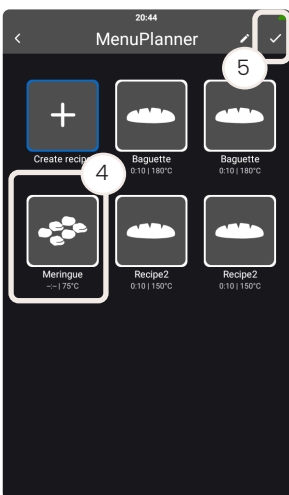

4. Select the recipes you want to add to the menu.



When you select a recipe, the recipes which are within the same delta are highlighted giving you an overview of the recipes you can add to a menu.

Make sure that there is a green check mark on all the recipes you want to add in your menu.

5. Touch the done icon.

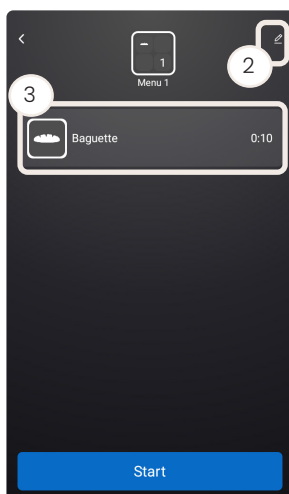

Changing cooking parameters

If you want to change an existing one-step recipe that is part of other menus, make sure to duplicate the recipe. Otherwise, you overwrite the recipe and risk that the delta of the recipe is changed so that the recipe no longer is part of the original menus.

IMPORTANT!

1. Select the menu and recipe to which you want to change the cooking parameters.
2. Touch the edit icon.
3. Touch the recipe.
4. Touch the recipe step.
5. Touch "Edit"

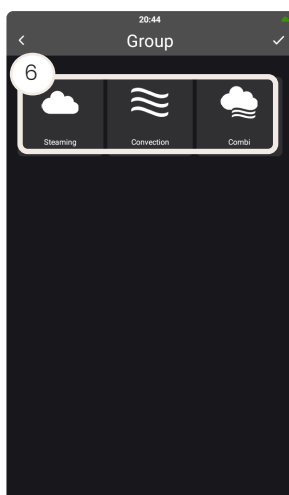
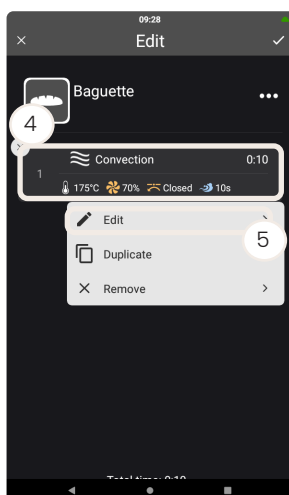

6. Select the desired cooking mode.

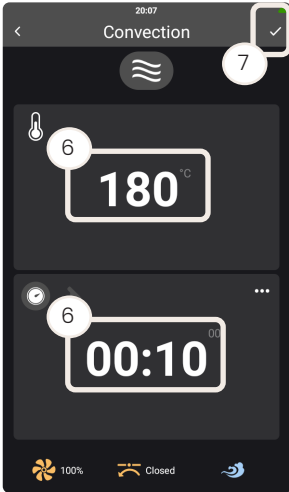

7. Select the desired cooking parameters such as temperature and time.
8. Touch the done icon.

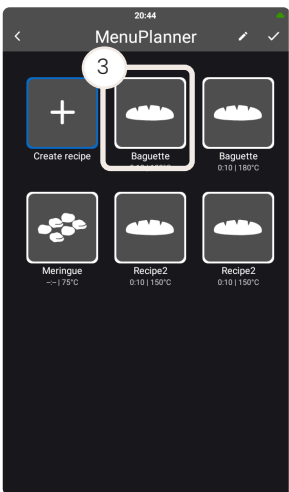

Starting MenuPlanner

1. Touch "More" in the home screen menu.
2. Touch "MenuPlanner".
3. Touch the menu you want to start.

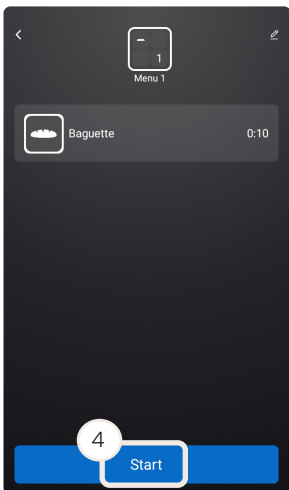

4. Touch "Start".

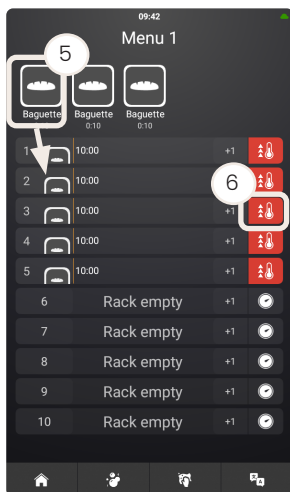

5. Hold your finger on the recipe you want to cook and drag it to the desired rack.



Instead of drag and drop, you can touch the rack and select up to three recipes to be added. Confirm by touching the rack again and a TablePlanner is created.



You can move one recipe from one rack to another by holding your finger on the recipe to move and drag it to the desired rack.



Opening and closing the door will start and clear racks.

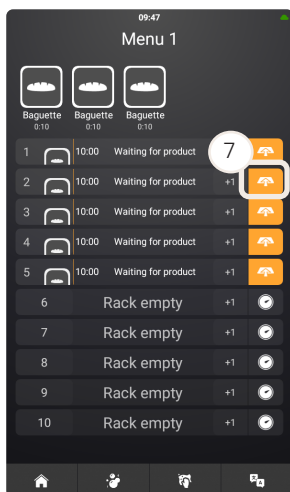

6. The oven starts preheating.
7. Load the oven when the load oven symbol shows.

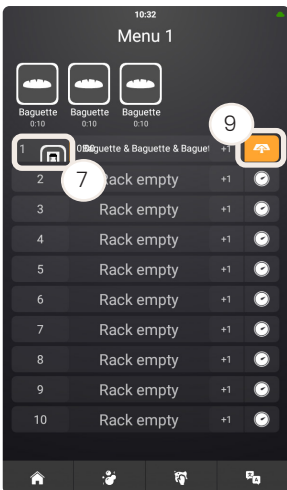
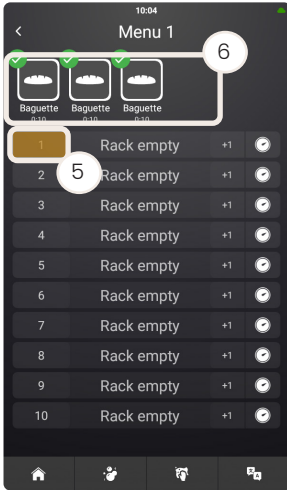

Using the TablePlanner function

The TablePlanner function allows you to combine up to three different products with one timer. Simply select your menu item; the oven will tell you when to load which item, and they will be ready for service at the same time.

1. Touch "More" in the home screen menu.
2. Touch "MenuPlanner".
3. Touch the desired menu.
4. Touch "Start".
5. Touch the desired rack number.
6. Touch the recipes to be cooked together. You can add up to three recipes to be cooked together.
7. Touch the rack number again and the TablePlanner icon shows.
8. If the oven is not preheated, the oven starts preheating.
9. Load the oven when the load oven icon shows. The oven will inform you which item to load first, second and third.



The CookTimeCorrection intelligence automatically compensates for temperature changes, e.g. when the door has been opened to add or remove products, ensuring perfect results every time.



Using the Startup timer function

The Startup timer function automatically powers up and preheats the oven to be ready for a specific recipe.

Function	Description
"Single timer"	Starts a recipe at a selected time and date.
"Recurrent timer"	Starts a recipe at a selected time and date, and repeats it every week.

Table 11

1. Touch "More" in the screen menu.
2. Touch "Startup timer".
3. Select whether you want to set a single timer or a recurrent timer.

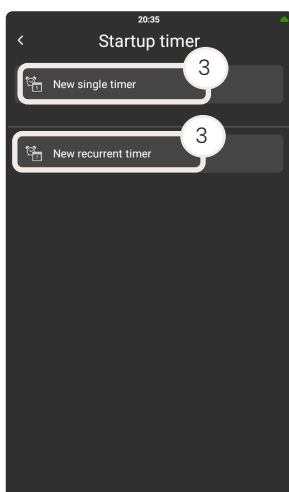

4. If you select the single timer functions, define the time and date.

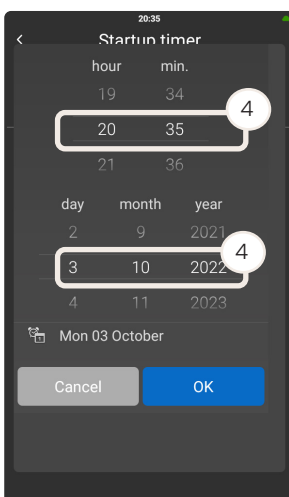

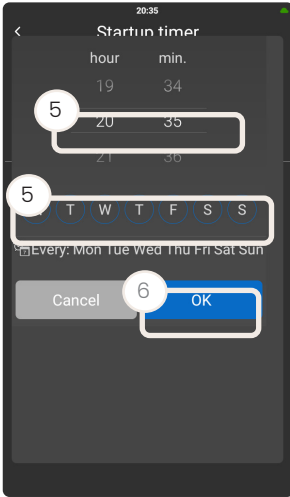

5. If you select the recurrent timer function, define the time and the day/days it should be repeated.
6. Touch "OK".

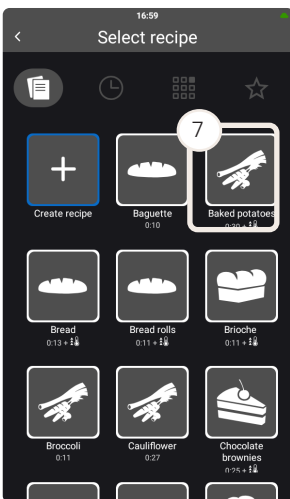

7. Touch the recipe you want to add to the "startup timer" function.

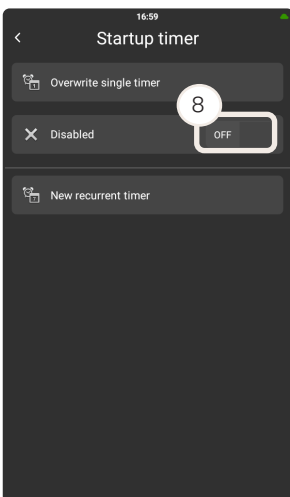

8. To deactivate a specific timer, slide the bar from "ON" to "OFF".

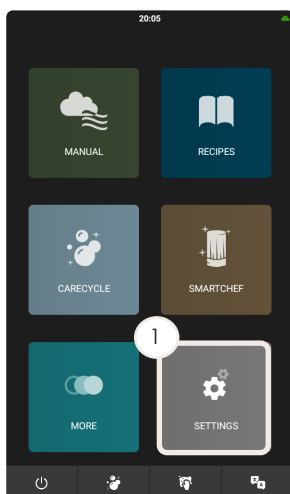

Using the Settings menu

1. Touch "Settings" in the home screen menu.
2. The last used functions and settings are viewed.

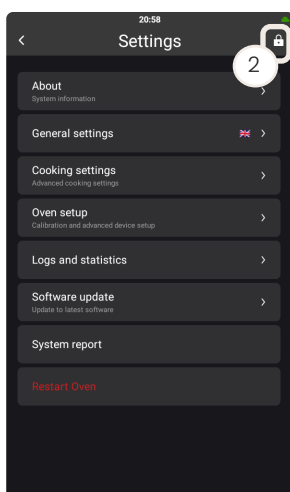

Changing user

Before you start the maintenance process or change settings, you must open the "Settings" menu.

1. Touch "Settings" in the home screen menu.
2. Touch the locked icon in the upper right corner.
3. Touch the key icon.
4. Enter the code for the access rights needed.

User role	Access rights	Code
"User"	Access to the user menu	-
"Superuser"	Access to the user and superuser menu	876412

Table 12

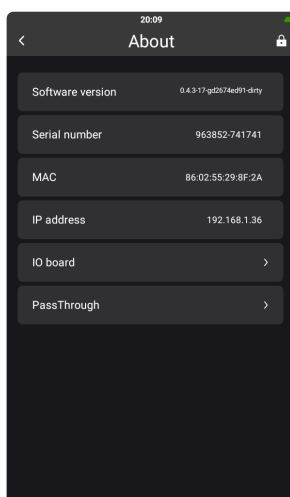

Finding the system information



The system information is important when you contact your local service partner in case of service or repair.

1. Touch "Settings" in the home screen menu.
2. Touch "About".
3. In this view, you can see the software version, oven serial number and IP address.

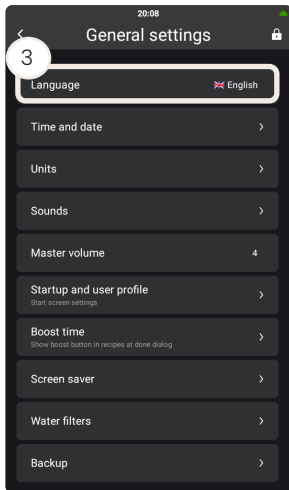

Changing the general settings

Changing language

1. Touch "Settings" in the home screen menu.
2. Touch "General settings".
3. Touch "Language".
4. Touch the relevant language.

Changing the time and date

1. Touch "Settings" in the home screen menu.
2. Touch "General settings".
3. Touch "Time and date".
4. Touch the relevant bar and make the necessary changes.

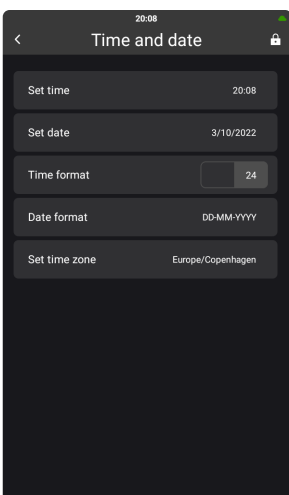

Value	Description
"Set time"	Set the hours and minutes.
"Set date"	Set the day month and years.
"Time format"	Toggle between a 12-hour or 24-hour time format.
"Date format"	Select between the DD-MM-YYYY and MM-DD-YYYY date format.
"Set time zone"	Select between the different time zones.

Table 13

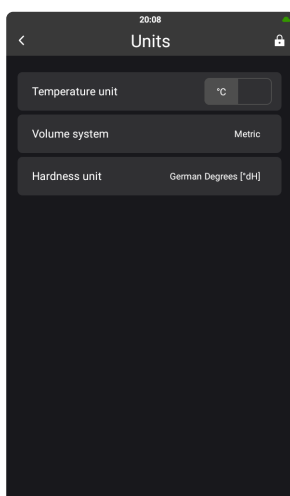

Changing units

1. Touch "Settings" in the home screen menu.
2. Touch "General settings".
3. Touch "Units".
4. Touch the relevant setting.

Value	Description
"Temperature unit"	Toggle between °C and °F.
"Volume system"	Select between metric and US system.
"Hardness unit"	Select between dH and ppm.

Table 14

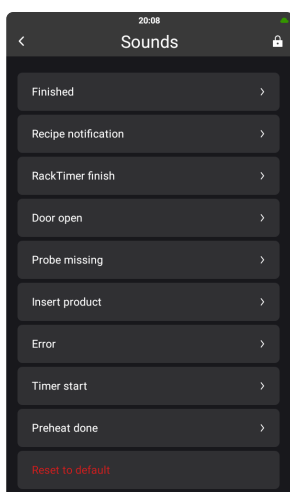

Changing sounds

1. Touch "Settings" in the home screen menu.
2. Touch "General settings".
3. Touch "Sounds".
4. Touch the action to which you want to change the sound.



You can always return to the default settings by touching the "Reset to default" button.

You can customise your sounds to indicate when to do something with your products in the oven, when to remove products from the oven, if a specific employee should do something, if it is the upper or lower oven, etc.

Value	Description
"Sound file"	Select the sound of the alarm.
"Repeat"	Define how often the alarm should be repeated.
"Volume"	Set the volume of the sound in %.
"Test sound"	Touch the button to perform an audio test of sound.

Table 15

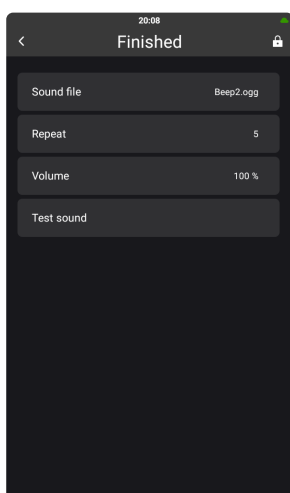

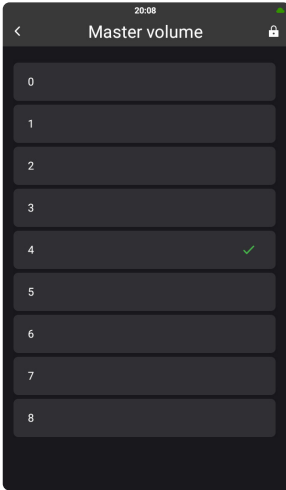

Changing master volume

1. Touch "Settings" in the home screen menu.
2. Touch "General settings".
3. Touch "Master volume".
4. Touch the relevant level of volume.

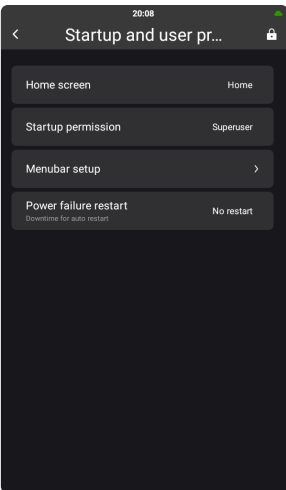

Changing the startup and user profile

1. Touch "Settings" in the home screen menu.
2. Touch "General settings".
3. Touch "Startup and user profile".
4. Make the relevant changes.

Value	Description
"Home screen"	Select your home screen. You can choose between: "Home", "Favourites", "Recipes", "MenuPlanner" and "QSR".
"Startup permission"	Select "Superuser" to have access to all general settings and editing. This is default. Select "User" to have limited access to general settings and editing.
"Menubar setup"	Create shortcuts from different functions to the menubar. You can select up to five shortcuts and choose between ten different features.
"Power failure restart"	Define when the oven should restart after power failure. You can choose between: no restart and after 10, 20 or 30 minutes.

Table 16

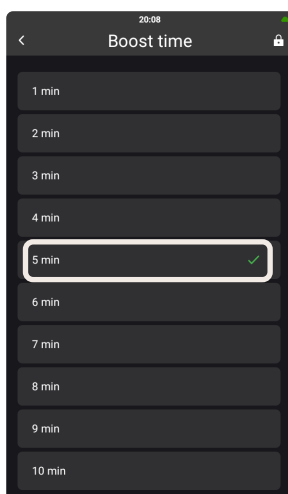
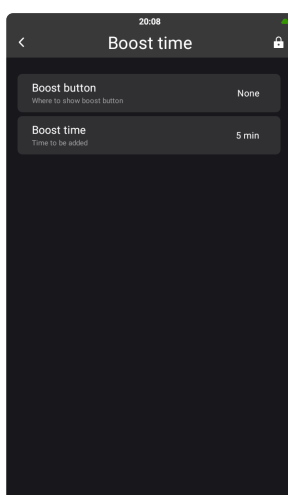
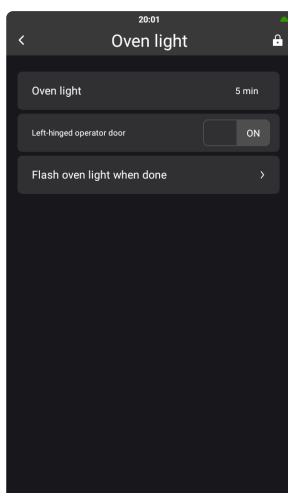

Changing the oven light

1. Touch "Settings" in the home screen menu.
2. Touch "Oven setup".
3. Touch "Oven light".
4. Make the relevant changes.

Value	Description
"Oven light"	Define if the oven light should stay on continuously or for 5 minutes
"Left-hinged operator door"	Define whether the oven door is left-mounted or not.
"Flash oven light when done"	Define if the oven light should flash in one or more of the following situations: "Manual", "RackTimer", "Recipe", "SmartChef", "MenuPlanner".

Table 18

Adding more time

1. Touch "Settings" in the home screen menu.
2. Touch "General settings".
3. Touch "Boost time".
4. Touch the amount of time to add.

Value	Description
"Boost button"	Define if and where you want to add the boost button. You can select between: "None", "Operator display" or "Operator and service display". The service display is only available on PassThrough ovens.
"Boost time"	Define how much time you want to add to the cooking time. You can select between one minute and up to ten minutes in one-minute intervals. This function is only available on recipes. With this function, you can select "Finish" if your product is done, or you can add more cooking time.

Table 17

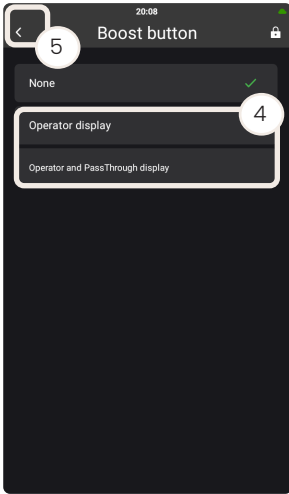

Using the boost button

The boost button gives you the possibility to add more time to the cooking time. You can select between 1-10 minutes.

1. Touch "Settings" in the home screen menu.
2. Touch the "General settings".
3. Touch "Boost button".
4. Touch either "Operator display" or "Operator and service display" (only available on PassTrough ovens).
5. Touch the back button.
6. Touch "Boost time"
7. Touch how much time to be added to the cooking time. The default setting is 5 minutes.
8. When the cooking time is done, push the boost button on the operator display or service display to add more time.



The boost button is only visible when running recipes. The time added is based on the settings from the last cooking step in the recipe.



Use the booster function when measuring the core temperature using an external core probe.

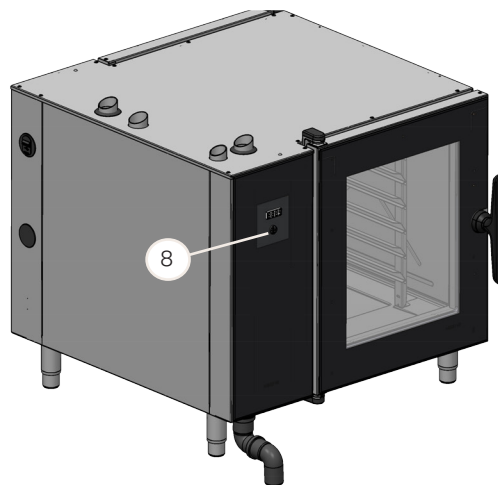
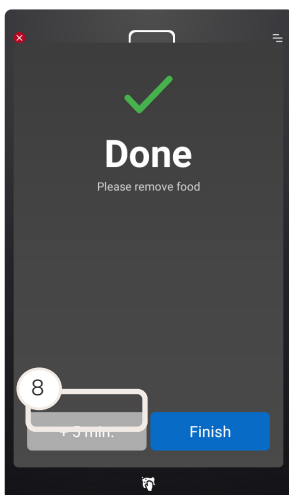

PassThrough oven

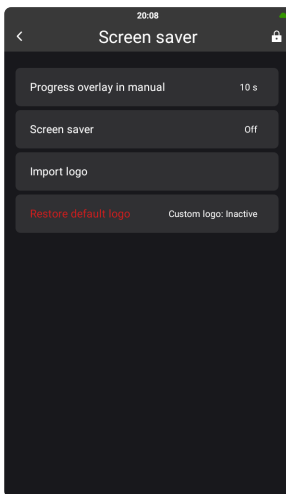

Changing the screen saver

1. Touch "Settings" in the home screen menu.
2. Touch the "General settings".
3. Touch "Screen saver".
4. Touch either "Progress overlay in manual" or "Screen saver".
5. Select "Off" if you do not want the screen saver or overlay function, or select the relevant amount of time before the screen saver or the progress overlay is activated.

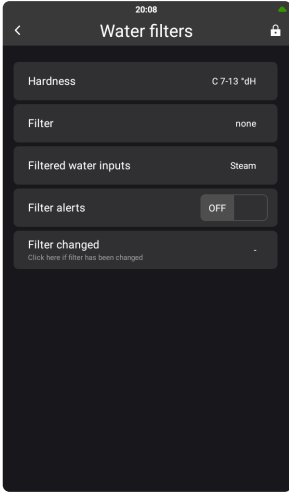

Setting the HydroShield water filter

When you have replaced the HydroShield water filter, you must update the HydroShield water filter settings according to the new HydroShield water filter.



We highly recommend that you use the water drop test to test the water hardness as this test is more precise and thus you get better utilisation of the HydroShield water filter.

See section "Testing the water hardness" in the installation manual.

1. Touch "Settings" in the home screen menu.
2. Touch "General settings".
3. Touch "Water filters".
4. Make the relevant changes.

Value	Description
"Hardness"	Select the water hardness based on the result of the water hardness test. Use "Simple" mode if you use the water test strips or "Advanced" mode if you use the water drop test.
"Filter"	Select the HydroShield water filter size that you have installed.
"Filtered water inputs"	Select between "none", "steam" and "steam & wash".
"Filter alerts"	Toggle the filter alert on or off.
"Filter changed"	Touch "Filter changed" to reset the counters.

Table 19

For more information about how to mount the HydroShield water filter, see section "Replacing the HydroShield water filter".

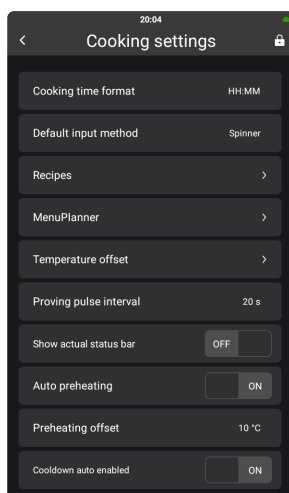

Changing the cooking settings

1. Touch "Settings" in the home screen menu.
2. Touch "Cooking settings".
3. Make the relevant changes.

Value	Description
"Cooking time format"	You can choose between HH:MM and HH:MM:SS.
"Default input method"	Select between the keypad or the spinner.
"MenuPlanner"	See section "Changing the MenuPlanner cooking settings".
"Proving pulse interval"	Set the interval in seconds.
"Show actual status bar"	Toggle the status bar on or off.
"Auto preheating"	Toggle automatic preheating on or off.
"Preheating offset"	Change the preheating offset.
"Cooldown auto enabled"	Toggle the function on or off.
"Cooldown offset"	Define the offset temperature.
"Cooldown start offset"	Define the start offset temperature.

Table 20

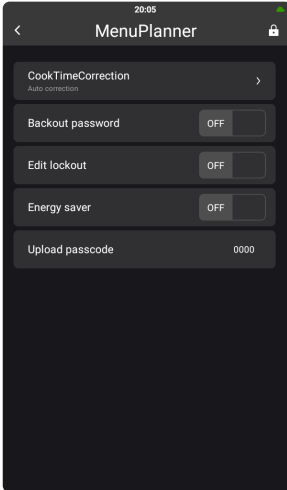

Changing the MenuPlanner cooking settings

1. Touch "Settings" in the home screen menu.
2. Touch "Cooking settings".
3. Touch "MenuPlanner".
4. Make the relevant changes.

Value	Description
"CookTimeCorrection"	See section "Changing the CookTimeCorrection settings".
"Backout password"	Toggle the MenuPlanner backout password on/off.
"Edit lockout"	Toggle the MenuPlanner edit lockout on/off.
"Energy saver"	Toggle the MenuPlanner energy saver on/off.
"Upload passcode"	Lock the user interface so no one can change the recipes.

Table 21

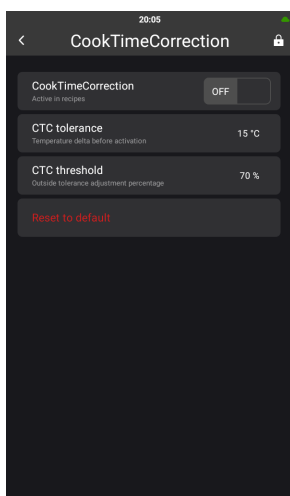

Changing the CookTimeCorrection settings

1. Touch "Settings" in the home screen menu.
2. Touch "Cooking settings".
3. Touch "MenuPlanner".
4. Touch "CookTimeCorrection".
5. Make the relevant changes.

Value	Description
"CookTimeCorrection"	Toggle the function on/off.
"CTC tolerance"	Set the temperature delta before action.
"CTC threshold"	Set the outside time adjustment percentage.

Table 22

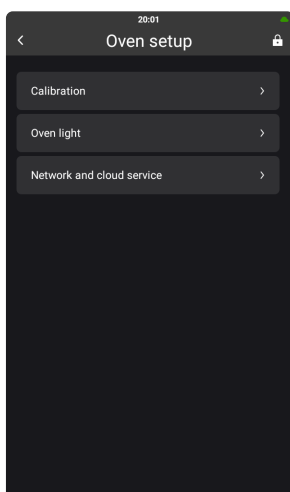

Changing the oven setup

1. Touch "Settings" in the home screen menu.
2. Touch "Oven setup".
3. Make the relevant changes.

Value	Description
"Calibration"	You can calibrate the following from this menu: operator door, service door and auto humidity.
"Oven light"	You can define the time the oven light is on and if the oven light should flash after an action has ended.
"Network and cloud service"	Touch "Network interface menu" to select between eth0 and eth1. Touch "Web address" to define to which server to connect the oven. Touch "Friendly name" to give the oven a friendly name in the cloud.

Table 23

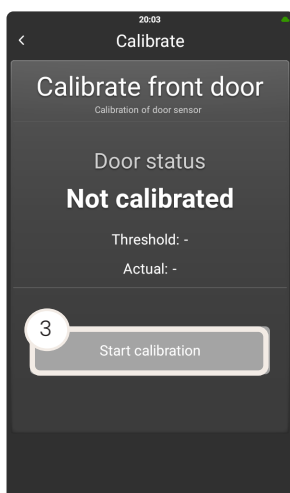

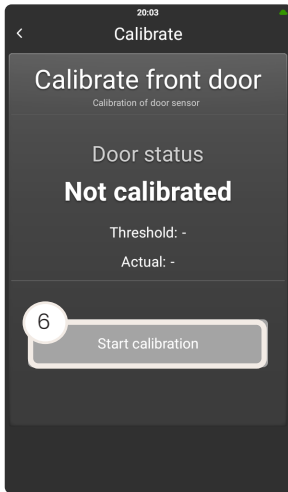

Calibrating the oven doors

Calibrating the operator door

1. Close the operator door.



If you are calibrating the operator door on a PassThrough oven, make sure that the service door also is closed.

2. Touch "Settings".
3. Touch "Oven setup"
4. Touch "Calibration".
5. Touch "Calibrate operator door".
6. Touch "Start calibration".
7. Follow the steps in the sequence guide on the display.

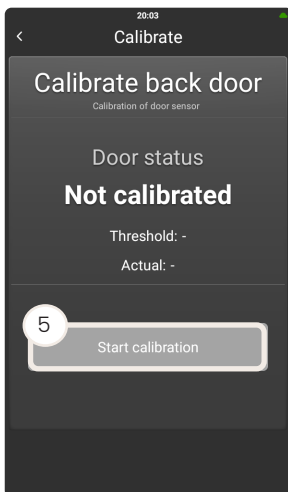

Calibrating the service door

This section is only relevant on PassThrough oven.

1. Close both the operator door and service door.
2. Touch "Settings".
3. Touch "Oven setup"
4. Touch "Calibration".
5. Touch "Calibrate service door".
6. Touch "Start calibration".
7. Follow the steps in the sequence guide on the display.

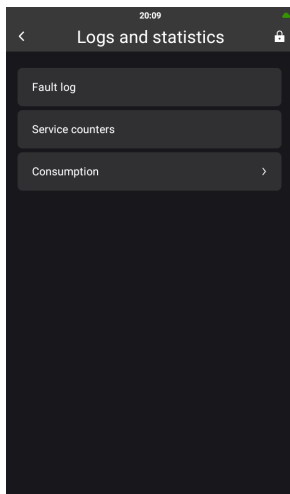

Monitoring logs and statistics

1. Touch "Settings" in the home screen menu.
2. Touch "Logs and statistics".

Value	Description
"Fault log"	Overview of the latest active errors in a list with the most recent error on top.
"Service counters"	Overview of how often a component has been activated and for how long.
"Consumption"	Set the trip counter for the energy meter and the water meter.

Table 24

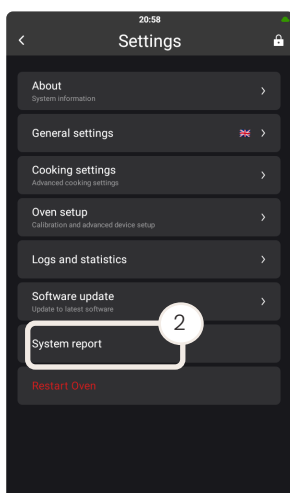

Creating a system report

1. Touch "Settings" in the home screen menu.
2. Insert a USB stick.
3. Touch "System report".

A .zip file is downloaded to the USB stick. You can now send the file to your local service partner.

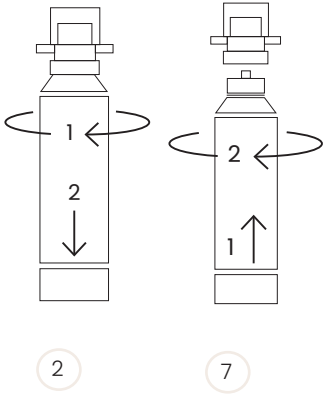

Replacing the HydroShield water filter

Always replace the HydroShield water filter:

- If the oven display shows the warning "Filter change needed".
 - On a regular basis and no later than 12 months after installation.
 - If the oven has not been used for four weeks or more.
- If you ignore replacing the filter, it will cause damage to the oven.

IMPORTANT!

1. Turn off the water supply.
2. Remove the HydroShield water filter by turning it clockwise.
3. Pull the HydroShield water filter out of the filter head.



CAUTION

Risk of slipping

- Be careful when you remove the used HydroShield water filter as it is heavy and filled with water.

4. Remove the new HydroShield water filter from the packaging.
5. Remove the hygiene cap.
6. Write the installation and replacement date on the filter.
7. Turn the HydroShield water filter anticlockwise in the filter head.
8. Reset the water filter. For more information, see section "Setting the HydroShield water filter".
9. Turn on the water supply.

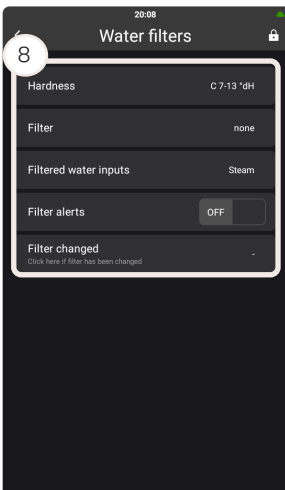

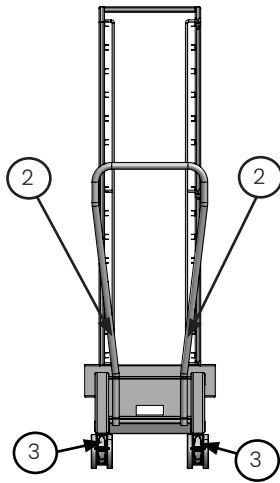

Loading and unloading a roll-in trolley



DANGER

Risk of crushing

- Always use the parking brake on roll-in trolleys.

1. Open the oven door.



The door must be completely open to remove the trolley from the oven.

2. Insert the removable handle bar into the holes on the base.
3. Release the locks on the wheels and carefully pull the trolley out of the oven cabinet.
4. Replace the roll-in trolley.
5. Close the oven door.

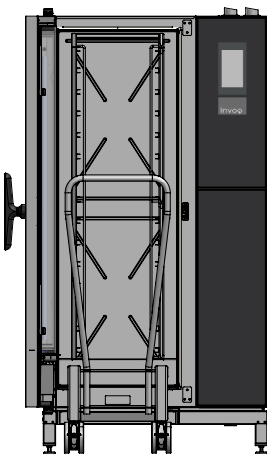
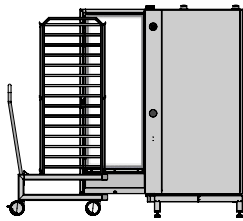

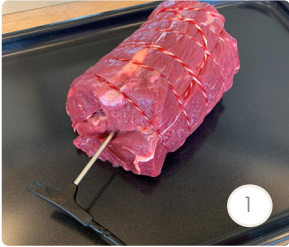

Using the core probe

The core probe contains multiple temperature sensor points. The oven always operates from the coolest of the three sensors when cooking.

1. For the most accurate result, insert the entire length at the centre of the product.

IMPORTANT!

If a product is too small or thin, inaccuracy of cooking may occur.

IMPORTANT!

If the product has a fat cap, insert the core probe above the centre of the product and closer to the fat cap.



When roasting for example whole chickens, insert the pin into the thickest part of the breast.

2. If you use a sous-vide probe, apply foam tape before piercing the sous-vide bag and insert the entire length at the center of the product.
3. Space the trays evenly in the oven cabinet to ensure good airflow.



If you use one tray only, use the middle shelf.

Meats with larger amounts of connective tissue

Meat that contains larger amounts of connective tissue, such as shoulder, brisket and neck must be cooked at low temperatures to make them tender. The holding time should be 30-90 minutes at a core temperature of 60-75°C. The more tissue, the more important the holding time becomes.

Buffets and displays



Always follow local regulations.

Meat prepared for a buffet or sales counter display must have a core temperature above 75°C. Remove the meat after no longer than three hours or when the core temperature falls below 65°C.

Cleaning the oven

We recommend that you clean the oven daily - both for hygienic reasons and to avoid interruptions of operation.



CAUTION

Risk of skin irritation

- Use personal protective equipment such as gloves to avoid direct contact with the CareCycle Clean and CareCycle Descale tabs.

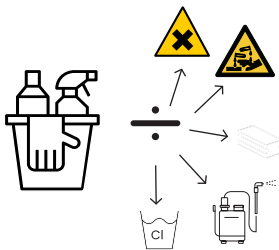

Cleaning the oven exterior

IMPORTANT!

Do not use a water hose or high-pressure cleaner to clean the oven exterior as it may damage the oven.

IMPORTANT!

Use a regular non-corrosive, non-toxic and non-chloride kitchen cleaning detergent (similar to table cleaning) and a soft cloth to clean the oven exterior. Do not use brushes or sponges as this may cause scratches to the steel.

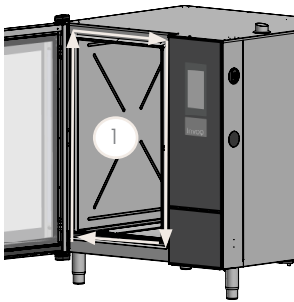

1. Clean the door sealing daily to keep the silicone clean and soft to ensure proper sealing.
2. Use a soft damp cloth and a liquid detergent to clean the oven exterior.
3. Clean the oven door and front using a window cleaner.
4. Treat the surface with steel oil.

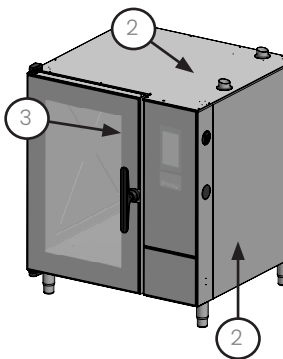

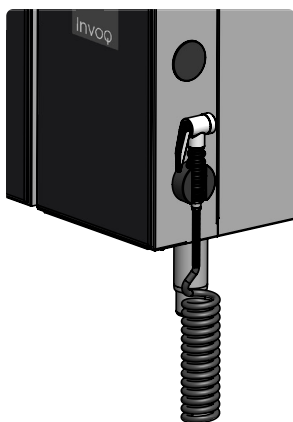

Using the hand shower

The hand shower is an optional extra.



DANGER

Risk of scalding

- Never spray water into the oven cavity when the oven temperature is above 100°C.

IMPORTANT! You can turn off the hand shower by the ball valve.

IMPORTANT! Never spray water into the oven cavity when the oven temperature is above 100°C.

Use the hand shower to wash down or flush away food remains from the oven cavity.

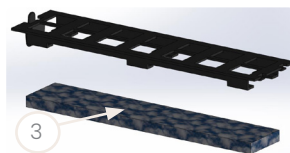
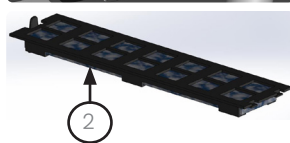
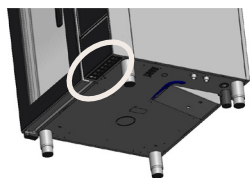

Cleaning the air intake filter

The filter is located below the control compartment.

- Clean the air intake filter when it is dirty or at least once a week. Otherwise, the controller and/or other electrical parts may overheat.
- Never use the oven without the air intake filter.

IMPORTANT!

1. Push the snap.
2. Remove the complete air intake filter.
3. Slide out and remove the air filter.
4. Clean the air filter under running water or in the dishwasher. Replace it, if necessary.
5. Remount the air intake filter in reverse order.

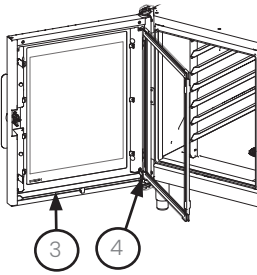
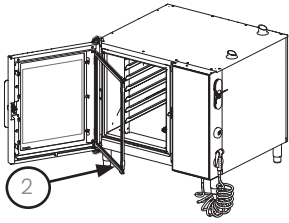

Cleaning the drip tray

The drip tray is located at the bottom of the inside of the oven door.

IMPORTANT! Clean the drip tray when it is dirty or at least once a week.

1. Open the oven door.
2. Release the inner glass.
3. Use a soapy water cloth to wipe clean the drip tray.
4. If the water outlet is clogged, use the hand shower to clean it.
5. Fasten the inner glass.
6. Close the oven door.

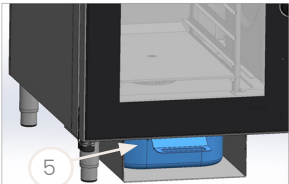
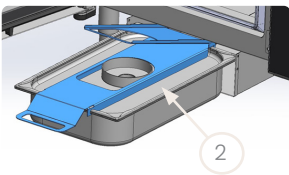

Cleaning the fat separation

The fat separation is a factory-fitted optional extra. It is located in the oven cavity and beneath the oven.

IMPORTANT! Clean the fat separation container after every wash.

1. Pour ½ litre of drinking water through the siphon in the oven cavity.
2. Remove the fat separation container from beneath the oven.
3. Throw away the dirty water.
4. Clean the fat separation container either by hand or in the dishwasher.
5. Push the fat separation container into the box beneath the oven.

Regular maintenance and cleaning

Interval	Type of maintenance and cleaning
Daily	Cleaning the oven exterior. See section "Cleaning the oven exterior".
Weekly	Cleaning the air intake filter. See section "Cleaning the air intake filter". Cleaning the drip tray. See section "Cleaning the drip tray"
Yearly	Replace the HydroShield water filter, if it has not been changed during the past year. See section "Replacing the HydroShield water filter".
Every wash	Clean the fat separation container after every wash. See section "Cleaning the fat separation".

Table 25

IMPORTANT! We highly recommend that you follow the CareCycle guides on the oven.

Technical data

Capacity

Capacity	6-1/1 GN	10-1/1 GN	20-1/1 GN
Capacity and tray sizes [mm]	1/1 GN; US sheet; 400x600 EN	1/1 GN; US sheet; 400x600 EN	1/1 GN; US sheet; 400x600 EN
Number of runners 70 mm distance	7 x 1/1 GN	10 x 1/1 GN	20 x 1/1 GN
Number of runners 85 mm distances	6 x 1/1 GN	8 x 1/1 GN	15 x 1/1 GN
Number of runners 80 mm distances	6 x EN	9 x EN	16 x EN
Number of runners 95 mm distance	5 x EN	8 x EN	14 x EN
Maximum food load per tray [kg]	4.5	4.5	4.5
Maximum food load per oven [kg]	31.5	45	90

Table 26

Capacity	6-2/1 GN	10-2/1 GN	20-2/1 GN
Capacity and tray sizes [mm]	2/1 GN; 1/1 GN	2/1 GN; 1/1 GN	2/1 GN; 1/1 GN
Number of runners 70 mm distance	7 x 2/1 GN; 14 x 1/1 GN	10 x 2/1 GN; 20 x 1/1 GN	20 x 2/1 GN; 40 x 1/1 GN
Number of runners 85 mm distances	6 x 2/1 GN 12 x 1/1 GN	8 x 2/1 GN 16 x 1/1 GN	15 x 1/1 GN
Maximum food load per tray [kg]	9	9	9
Maximum food load per oven [kg]	63	90	180

Table 27

Capacity – PassThrough

Capacity	6-1/1 GN	10-1/1 GN
Capacity and tray sizes [mm]	1/1 GN; US sheet; 400x600 EN	1/1 GN; US sheet; 400x600 EN
Number of runners 70 mm distance	7 x 1/1 GN	10 x 1/1 GN
Number of runners 85 mm distances	6 x 1/1 GN	8 x 1/1 GN
Number of runners 80 mm distances	6 x EN	9 x EN
Number of runners 95 mm distance	5 x EN	8 x EN
Maximum food load per tray [kg]	4.5	4.5
Maximum food load per oven [kg]	31.5	45

Table 28

Core temperature guidelines for meat

Product	Temperature [°C]
Pieces of saddle, tenderloin or ham (lean)	60-65
Roast of saddle or ham	65
Pieces of meat that contain a large amount of connective tissue such as neck, brisket and shoulder	80
Pâté	75
Terrine	60
Rare roast	56-59
Medium roast	59-64
Well-done roast	65-70

Table 29

Core temperature guidelines for fish

Product	Temperature [°C]
Fish without bones	55
Fish with bones	60
Fish pâté	65

Table 30

Core temperature guidelines for Delta-T

Product	Temperature [°C]
Rare	52-57
Medium rare	59-62
Well done	72-87

Table 31

Disposing of the oven

The oven contains recyclable materials. Disposal of the oven or parts of it must happen in an environmental sound way according to the WEE regulation, Directive 2012/19/EU or local regulations for countries outside the EU.



GET IN TOUCH.

As your oven specialist, we always do our utmost to help our customers. Worldwide.

Blodgett
42 Allen Martin Drive
Essex Junction, VT 05452
USA

T: 802-658-6600
M: custserv@blodgett.com

www.blodgett.com

Part of

