

BUNN®

AXIOM®

BrewWISE®

SERIES



INSTALLATION & OPERATING GUIDE

BUNN-O-MATIC CORPORATION

POST OFFICE BOX 3227

SPRINGFIELD, ILLINOIS 62708-3227

PHONE: (217) 529-6601 FAX: (217) 529-6644

To ensure you have the latest revision of the Operating Manual, or to view the Illustrated Parts Catalog, Programming Manual, or Service Manual, please visit the Bunn-O-Matic website, at www.bunn.com. This is absolutely FREE, and the quickest way to obtain the latest catalog and manual updates. For Technical Service, contact Bunn-O-Matic Corporation at 1-800-286-6070.

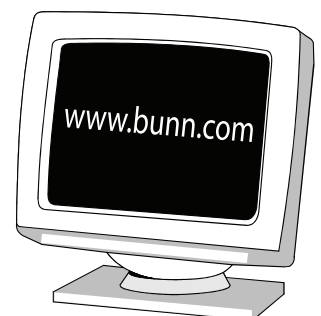

BUNN-O-MATIC COMMERCIAL PRODUCT WARRANTY

Bunn-O-Matic Corp. ("BUNN") warrants equipment manufactured by it as follows:

- 1) Airpots, thermal carafes, decanters, GPR servers, iced tea/coffee dispensers, MCP/MCA pod brewers thermal servers and Thermofresh servers (mechanical and digital)- 1 year parts and 1 year labor.
- 2) All other equipment - 2 years parts and 1 year labor plus added warranties as specified below:
 - a) Electronic circuit and/or control boards - parts and labor for 3 years.
 - b) Compressors on refrigeration equipment - 5 years parts and 1 year labor.
 - c) Grinding burrs on coffee grinding equipment to grind coffee to meet original factory screen sieve analysis - parts and labor for 4 years or 40,000 pounds of coffee, whichever comes first.

These warranty periods run from the date of installation BUNN warrants that the equipment manufactured by it will be commercially free of defects in material and workmanship existing at the time of manufacture and appearing within the applicable warranty period. This warranty does not apply to any equipment, component or part that was not manufactured by BUNN or that, in BUNN's judgment, has been affected by misuse, neglect, alteration, improper installation or operation, improper maintenance or repair, non periodic cleaning and descaling, equipment failures related to poor water quality, damage or casualty. In addition, the warranty does not apply to replacement of items subject to normal use including but not limited to user replaceable parts such as seals and gaskets. This warranty is conditioned on the Buyer 1) giving BUNN prompt notice of any claim to be made under this warranty by telephone at (217) 529-6601 or by writing to Post Office Box 3227, Springfield, Illinois 62708-3227; 2) if requested by BUNN, shipping the defective equipment prepaid to an authorized BUNN service location; and 3) receiving prior authorization from BUNN that the defective equipment is under warranty.

THE FOREGOING WARRANTY IS EXCLUSIVE AND IS IN LIEU OF ANY OTHER WARRANTY, WRITTEN OR ORAL, EXPRESS OR IMPLIED, INCLUDING, BUT NOT LIMITED TO, ANY IMPLIED WARRANTY OF EITHER MERCHANTABILITY OR FITNESS FOR A PARTICULAR PURPOSE. The agents, dealers or employees of BUNN are not authorized to make modifications to this warranty or to make additional warranties that are binding on BUNN. Accordingly, statements by such individuals, whether oral or written, do not constitute warranties and should not be relied upon.

If BUNN determines in its sole discretion that the equipment does not conform to the warranty, BUNN, at its exclusive option while the equipment is under warranty, shall either 1) provide at no charge replacement parts and/or labor (during the applicable parts and labor warranty periods specified above) to repair the defective components, provided that this repair is done by a BUNN Authorized Service Representative; or 2) shall replace the equipment or refund the purchase price for the equipment.

THE BUYER'S REMEDY AGAINST BUNN FOR THE BREACH OF ANY OBLIGATION ARISING OUT OF THE SALE OF THIS EQUIPMENT, WHETHER DERIVED FROM WARRANTY OR OTHERWISE, SHALL BE LIMITED, AT BUNN'S SOLE OPTION AS SPECIFIED HEREIN, TO REPAIR, REPLACEMENT OR REFUND.

In no event shall BUNN be liable for any other damage or loss, including, but not limited to, lost profits, lost sales, loss of use of equipment, claims of Buyer's customers, cost of capital, cost of down time, cost of substitute equipment, facilities or services, or any other special, incidental or consequential damages.

392, A Partner You Can Count On, Air Infusion, AutoPOD, AXIOM, BrewLOGIC, BrewMETER, Brew Better Not Bitter, BrewWISE, BrewWIZARD, BUNN Espresso, BUNN Family Gourmet, BUNN Gourmet, BUNN Pour-O-Matic, BUNN, BUNN with the stylized red line, BUNNlink, Bunn-O-Matic, Bunn-O-Matic, BUNNserve, BUNNSERVE with the stylized wrench design, Cool Froth, DBC, Dr. Brew stylized Dr. design, Dual, Easy Pour, EasyClear, EasyGard, FlavorGard, Gourmet Ice, Gourmet Juice, High Intensity, iMIX, Infusion Series, Intellisteam, My Café, Phase Brew, PowerLogic, Quality Beverage Equipment Worldwide, Respect Earth, Respect Earth with the stylized leaf and coffee cherry design, Safety-Fresh, savemycoffee.com, Scale-Pro, Silver Series, Single, Smart Funnel, Smart Hopper, SmartWAVE, Soft Heat, SplashGard, The Mark of Quality in Beverage Equipment Worldwide, ThermoFresh, Titan, trifacta, Velocity Brew, Air Brew, Beverage Bar Creator, Beverage Profit Calculator, Brew better, not bitter., BUNNSource, Coffee At Its Best, Cyclonic Heating System, Daypart, Digital Brewer Control, Element, Milk Texturing Fusion, Nothing Brews Like a BUNN, Pouring Profits, Signature Series, Sure Tamp, Tea At Its Best, The Horizontal Red Line, Ultra are either trademarks or registered trademarks of Bunn-O-Matic Corporation. The commercial trifacta® brewer housing configuration is a trademark of Bunn-O-Matic Corporation.

INTRODUCTION

This equipment will brew a 1/2 gallon batch of coffee into an awaiting server. The brewer may have a hot water faucet for allied beverage use. It is only for indoor use on a sturdy counter or shelf.

CONTENTS

Warranty.....	2
User Notices	3
Electrical Requirements.....	4
Plumbing Requirements & Initial Set-Up.....	6
Operating Controls & Coffee Brewing.....	7
Cleaning & Tank Drain	8
Adjustments & Optional Settings	9

USER NOTICES

Carefully read and follow all notices in this manual and on the equipment. All labels on the equipment should be kept in good condition. Replace any unreadable or damaged labels.



#00658.0000



#12364.0000



#37881.0002

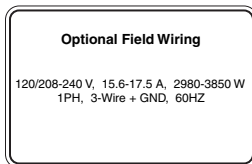

#29710.0007

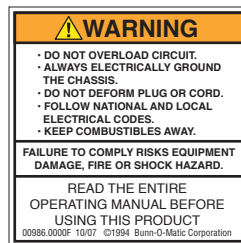

#00986.0000



#00824.0002



#03408.0002

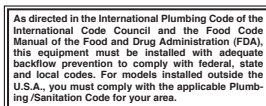

#00656.0001



#00824.0001



#03409.0002

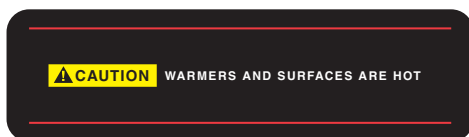

#02765.0000

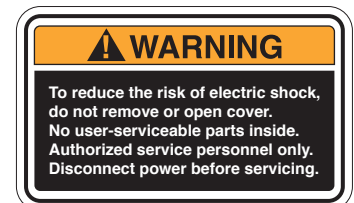

#37881.0000

ELECTRICAL REQUIREMENTS

WARNING -

The brewer must be disconnected from the power source until specified in Initial Set-Up. Refer to Data Plate on the Brewer, and local/national electrical codes to determine circuit requirements.

ELECTRICAL HOOK-UP (All Models)

CAUTION – Improper electrical installation will damage electronic components.

1. An electrician must provide electrical service.
2. Determine the available on-site electrical service.
3. Select the desired unit voltage based on the available on-site electrical service.
4. Using a voltmeter, check the voltage and color coding of each conductor at the electrical source.
5. Remove the front access panel beneath the sprayhead to gain access to the terminal block.
6. Feed the supply leads through the rear of the brewer.
7. Using the above diagrams, connect the desired electrical service to the field wiring terminal block.
8. If wiring the machine for operation on 120/208 or 120/240 volts with a Power Supply Cord, the Power Supply Cord must be UL Listed Flexible Cord Type SO, SJO, SJTO, HSJO or SJOW, No. 12 AWG, 4 Conductor, Rated 90° C. Attachment Plug Cap must be UL Listed, NEMA 14-20P or L14-20P Configuration, Rated 125/250V, 20 AMPS. The Power Supply Cord must be at least 3 feet long and maximum 6 feet long (measured from Strain Relief to end of the Attachment Plug Cap).
9. Before proceeding, verify the voltage at the field wiring terminal block.
10. Set voltage switch to the appropriate position and replace the access panel. (DV Models Only)
11. If plumbing is to be hooked up later be sure the brewer is disconnected from the power source. If plumbing has been hooked up, the brewer is ready for Initial Set-Up.

CE REQUIREMENTS

- This appliance must be installed in locations where it can be overseen by trained personnel.
- For proper operation, this appliance must be installed where the temperature is between 5°C to 35°C.
- Appliance shall not be tilted more than 10° for safe operation.
- An electrician must provide electrical service as specified in conformance with all local and national codes.
- This appliance must not be cleaned by water jet.
- This appliance is not intended for use by persons (including children) with reduced physical, sensory or mental capabilities, or lack of experience and knowledge, unless they have been given instructions concerning use of this appliance by a person responsible for its safety.
- Children should be supervised to ensure they do not play with the appliance.
- If the power cord is ever damaged, it must be replaced by the manufacturer or authorized service personnel with a special cord available from the manufacturer or its authorized service personnel in order to avoid a hazard.
- Machine must not be immersed for cleaning.

ELECTRICAL REQUIREMENTS

Single & Dual Volt Models

Requirements for brewers with an attached cord set are as follows:

Note: This electrical service requires 2 current carrying conductors (Neutral, and L1) and a separate conductor for earth ground.

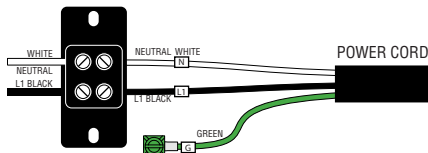

120V 2 WIRE + GROUND

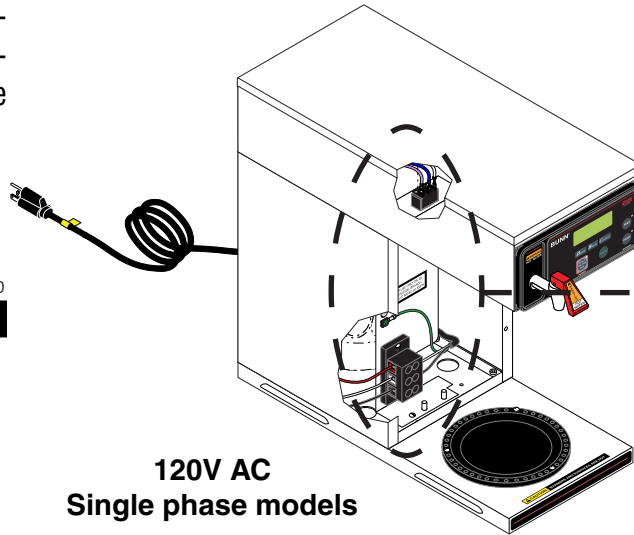

**120V AC
Single phase models**

**Dual Voltage Switch
in 120V position**

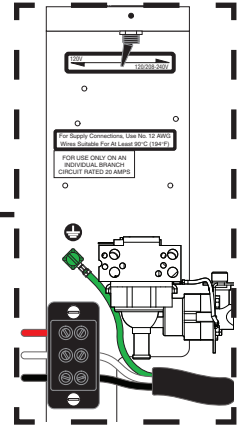

Requirements for brewers without an attached cord set are as follows:

Note: This electrical service require 3 current carrying conductors (Neutral, L1 and L2) and a separate conductor for earth ground

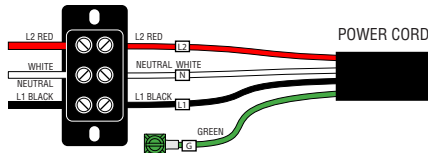

120/208-240V 3 WIRE + GROUND

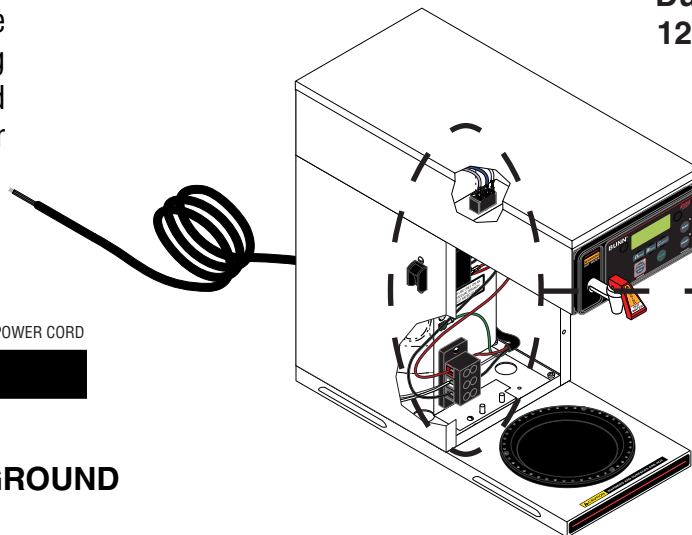

**120/208 & 120/240V AC
Single phase models**

**Dual Voltage Switch
in 120/208-240V position**

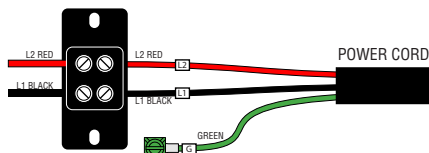
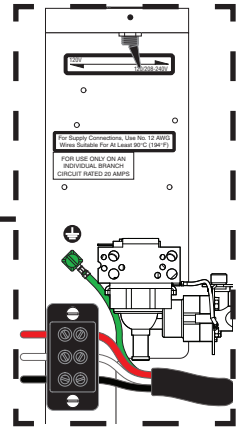

208-240V 2 WIRE + GROUND

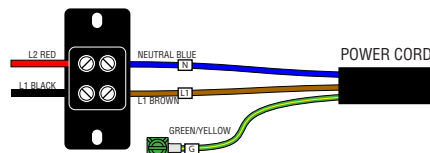

220-240V 2 WIRE + GROUND

PLUMBING REQUIREMENTS

These brewers must be connected to a cold water system with operating pressure between 20 and 90 psi (138 and 620 kPa) from a ½" or larger supply line. A shut-off valve should be installed in the line before the brewer. Install a regulator in the line when pressure is greater than 90 psi (620 kPa) to reduce it to 50 psi (345 kPa). The water inlet fitting is ¼" flare.

NOTE - Bunn-O-Matic recommends ¼" copper tubing for installations of less than 25 feet and ⅜" for more than 25 feet from the ½" water supply line. A tight coil of copper tubing in the water line will facilitate moving the brewer to clean the counter top. Bunn-O-Matic does not recommend the use of a saddle valve to install the brewer. The size and shape of the hole made in the supply line by this type of device may restrict water flow.

As directed in the International Plumbing Code of the International Code Council and the Food Code Manual of the Food and Drug Administration (FDA), this equipment must be installed with adequate backflow prevention to comply with federal, state and local codes. For models installed outside the U.S.A., you must comply with the applicable Plumbing /Sanitation Code for your area.

1. Flush the water line and securely attach it to the inlet fitting at the rear of the brewer.
2. Turn on the water supply.

INITIAL SET-UP

1. Insert an empty funnel into the funnel rails.
2. Place an empty server under the funnel.
3. Connect the brewer to the power source.
4. Turn on the main ON/OFF switch located on the left side or back of brewer (If equipped).
5. Water will flow into the tank and stop when the tank is filled to its capacity. Display will show **"PLEASE WAIT...TANK FILLING"** until tank is filled with water.
6. Wait approximately twenty minutes for the water in the tank to heat to the proper temperature. Display will show **"READY TO BREW...WATER TEMP: 200°"** when tank is at operating temperature. Some water will drip from the funnel during this time; this is due to expansion and should not occur thereafter.
7. Place a small container beneath the faucet and open the faucet handle. Release it when you hear the tank refilling.
8. Water volumes and flow settings have been preset at the factory. Refer to adjustments for the Set Brew Volumes section of this manual should the volume need to be increased or decreased.
9. The brewer is now ready for use in accordance with the instructions for Coffee Brewing.
10. Repeat steps 5-9 for remaining side on Twins.

Brew water temperature is factory set at 200° F (93.3° C) Areas of high altitude will require lowering this temperature to prevent boiling. This chart should be used as a guide when readjusting the brew water temperature.

Altitude (Feet)	Boiling point of water		Recommended water temperature	
	° F	° C	° F	° C
-1000	213.8	101.0	200	93.3
-500	212.9	100.5	200	93.3
0	212.0	100.0	200	93.3
500	211.1	99.5	200	93.3
1000	210.2	99.0	200	93.3
1500	209.3	98.5	200	93.3
2000	208.4	98.0	200	93.3
2500	207.4	97.4	200	93.3
3000	206.5	96.9	199	92.8
3500	205.6	96.4	198	92.2
4000	204.7	95.9	197	91.7
4500	203.8	95.4	196	91.1
5000	202.9	94.9	195	90.6
5500	201.9	94.4	195	90.6
6000	201.0	93.9	194	90.0
6500	200.1	93.4	193	89.4
7000	199.2	92.9	192	88.9
7500	198.3	92.4	191	88.3
8000	197.4	91.9	190	87.8
8500	196.5	91.4	189	87.2
9000	195.5	90.8	188	86.7
9500	194.6	90.3	187	86.1
10000	193.7	89.8	186	85.6

OPERATING CONTROLS

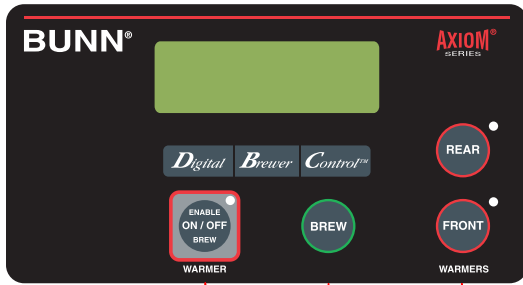

P3633

A

B

C

D

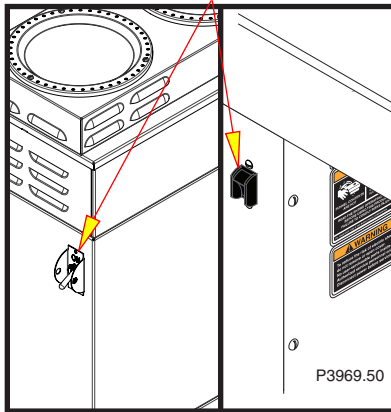

(A) ENABLE BREW ON/OFF SWITCH

Pressing the "ENABLE BREW ON/OFF" switch (indicator on) supplies power to the brew station warmer and enables the brew circuit. Pressing the switch again (indicator off) stops brewing and de-energizes the brew station warmer. Stopping a brew cycle after it has been started will not stop the flow of water into the server until the funnel is empty.

(B) BREW SWITCH

Momentarily pressing and releasing the switch starts a brew cycle when the "ENABLE BREW ON/OFF" indicator is on.

(C) ADDITIONAL WARMER SWITCHES

Pressing any additional warmer switch so that the indicator is on, supplies power to the associated warmer. **NOTE: APS & TC models have no warmers.**

(D) MAIN ON/OFF SWITCH

This switch, located on the left side of the brewer, turns power on and off to all components in the brewer.

COFFEE BREWING

1. Begin each brew cycle with a clean empty brew funnel.
2. Insert a BUNN filter into the funnel.
3. Pour (or grind) fresh coffee into the filter and level the bed of grounds by gently shaking.
4. Slide the funnel into the funnel rails until it stops.
5. Place an empty server under the funnel.
6. Verify that the "ENABLE BREW ON/OFF" indicator is on.
7. Momentarily press and release the "BREW" switch. The display will read "NOW BREWING", and show the time remaining in the brew cycle.
8. Following the brew, the display reads "DRIPPING" which shows the time remaining until the coffee no longer drips from the funnel tip.
9. After the coffee finishes dripping from the funnel tip, carefully remove the brew funnel and discard the grounds and filter.

CLEANING

1. The use of a damp cloth rinsed in any mild, nonabrasive, liquid detergent is recommended for cleaning all surfaces on Bunn-O-Matic equipment.
2. Check and clean the sprayhead. The sprayhead holes must always remain open. Insert the short end of the sprayhead cleaning tool into each of the five water outlets of the plastic sprayhead to remove any mineral deposits (Refer to Fig 1)
3. Insert the long end of sprayhead cleaning tool into the sprayhead fitting, and rotate several times to remove any mineral deposits from the fitting (Refer to Fig 2).

NOTE: In hard water areas, this may need to be done daily. It will help prevent liming problems in the brewer and takes less than a minute.

NOTE: In the event that the "Brew Logic" circuit activates (compensating for high lime build up), it will temporarily disable the "Recovery Booster" and "Pulse Brewing" systems until the unit has been de-limed. Refer to the Troubleshooting section for more details.



FIGURE 1

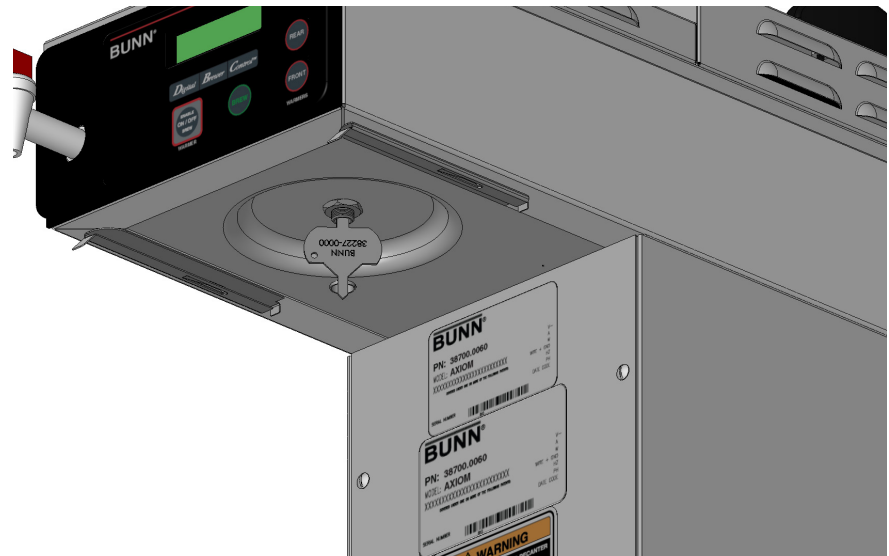
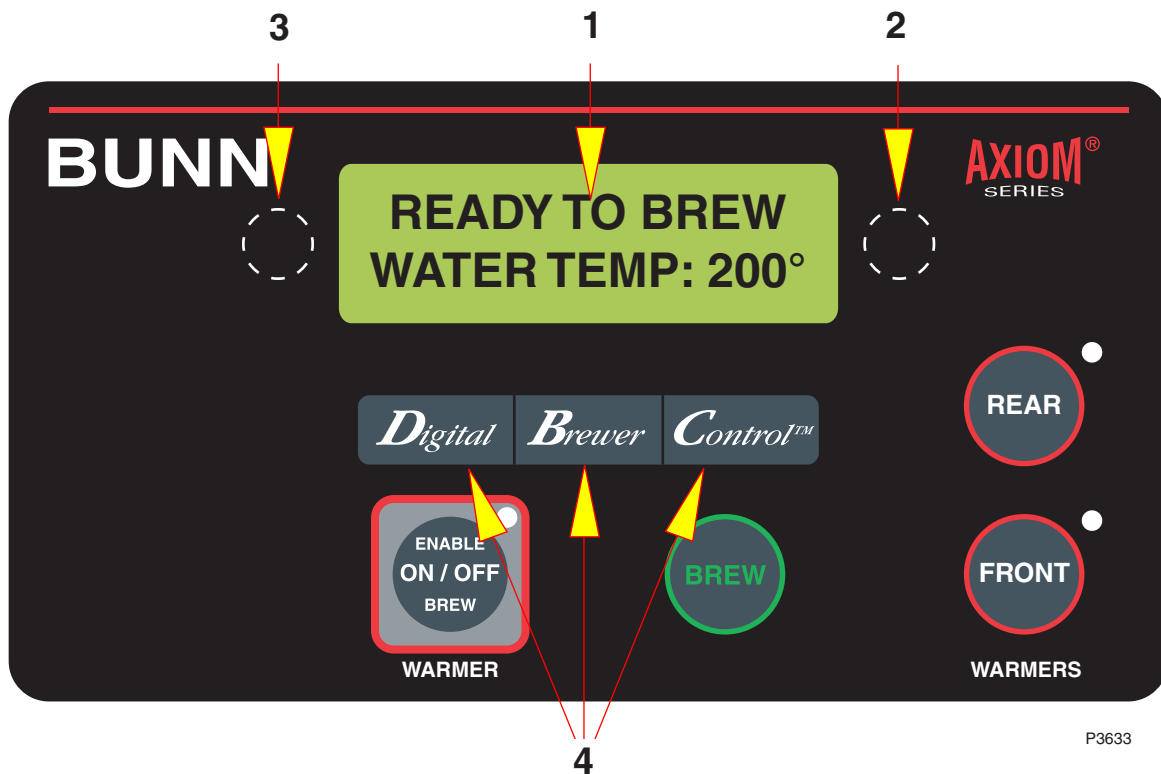

FIGURE 2

TANK DRAIN

1. Loosen screws that secure the front access panel. Remove the panel.
2. Unfasten the hose clamp at the end of the drain hose. Remove the plug.
3. Place the end of the drain hose in a container that has a minimum capacity of 200 oz (5.9 L).
4. Release the white clamp to drain water from the tank.
5. When tank is empty, close the white clamp, replace the plug, and tighten the clamp at the end of the drain hose.
6. Replace the front panel and tighten screws.

ADJUSTMENTS & OPTIONAL SETTINGS



P3633

Using the menu-driven display on the front of the brewer, the operator has the ability to alter or modify various brewing parameters such as brew lockout, brew volume, brew strength, etc. This allows for the precise brewing of various flavors of coffee.

Programming of the brewer is achieved by entering a certain function. Then, by the use of *hidden* programming switches, the operator can customize the brewing process to their specifications.

PROGRAMMING SWITCHES

1. FUNCTION SCREEN

This is the display which shows the various functions.

2. (Right of the display)

This is used to access the program mode and is also used to step forward through the menu.

3. (Left of the display)

This is used to access BrewWISE programming Mode, and also step backwards through the the menu.

4. "Digital" (lower left under the display)

This is used to select options that appear on the display during programming (NO/-)

"Brewer" (center under the display)

This is used to select options that appear on the display during programming (DONE)

"Control" (lower right under the display)

This is used to select options that appear on the display during programming (YES/+)

ADJUSTMENTS & OPTIONAL SETTINGS (CONT.)

PROGRAMMING FUNCTIONS OVERVIEW

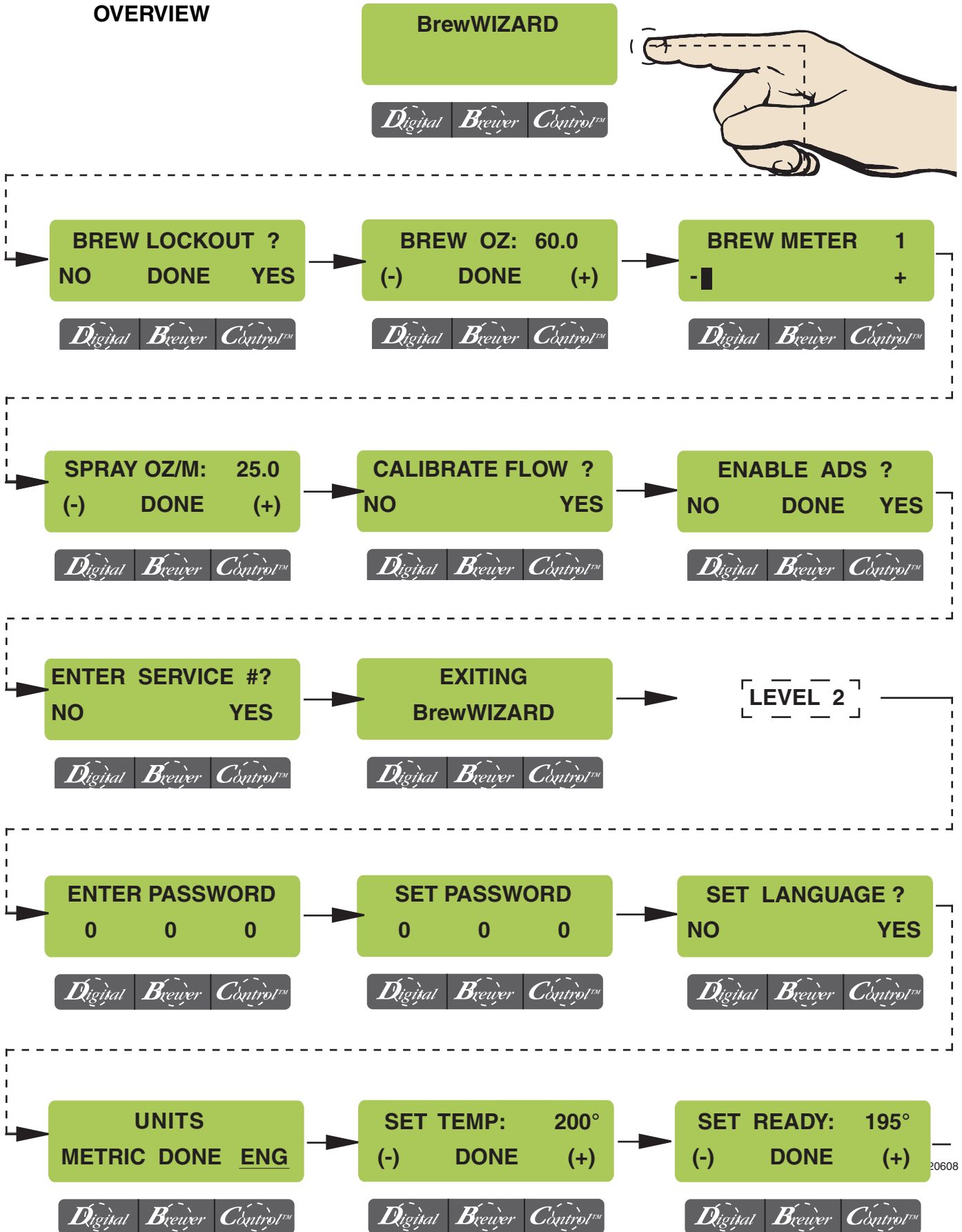

ADJUSTMENTS & OPTIONAL SETTINGS (CONT.)

LEVEL 2 (CONT.)

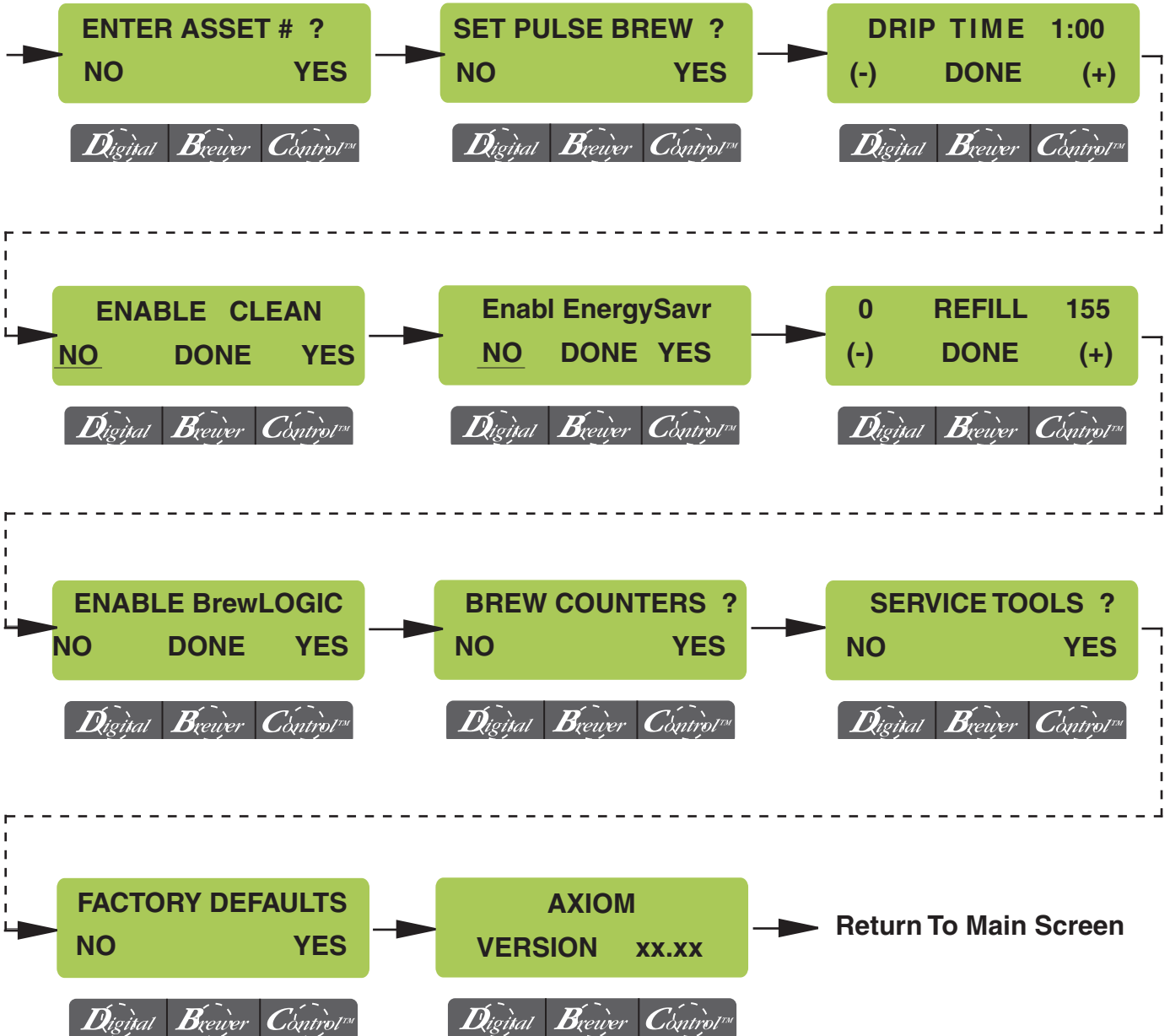

ADJUSTMENTS & OPTIONAL SETTINGS

PROGRAMMING THE BREWER

The programming of the brewer is divided into two levels. Brewing adjustments are in "BrewWizard". Service functions are accessed in Level 2.

The following function screens are in order of appearance. Each screen will have instructions on how to access, and the procedures to program the various functions of the brewer.

IMPORTANT PROGRAMMING NOTES

- READ CAREFULLY -

To exit the programming mode at any time, press and release "ENABLE BREW ON/OFF" switch located on the front switch panel. The display will return to the MAIN SCREEN.

If none of the five programming switches are pressed within one minute during the setup of the brewer, the programming of the function screen that is being set will be exited and the display will return to the MAIN SCREEN.

Always remember to place an empty server and funnel under the sprayhead when operating the brewer during the set-up of PULSE BREW, CALIBRATE FLOW and testing the brew valve in SERVICE TOOLS/TEST OUTPUTS.

PROGRAM FUNCTIONS - BREW WIZARD

MAIN SCREEN



READY TO BREW
WATER TEMP: 200°



BREW LOCKOUT

This function allows the operator to prevent or allow brewing if the water temperature is less than the set READY temperature.

To access this function screen press and hold the right hidden switch. Release when the display reads: "BREW WIZARD" it will then read:

PROGRAMMING LOCKOUT SWITCH (Mounted on main control board)

This switch can be set to prevent access to the programming settings of the brewer. Once all the correct brew settings are programmed, the operator can set the switch to the "LOCK" position to prohibit anyone from changing the settings. With the switch in the "LOCK" position, the programming menus can still be accessed to view the current settings. However, no changes will be saved.

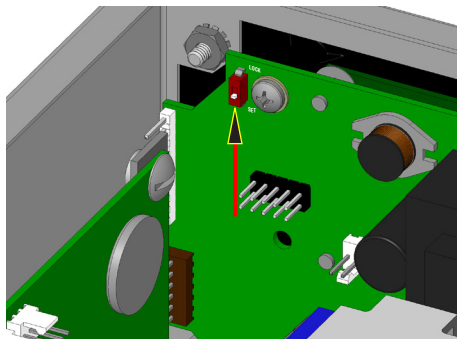

Disconnect brewer from power source before removing any panel!



BREW LOCKOUT?
NO DONE YES



Press here for **NO** Press here for **DONE** Press here for **YES**

The YES or NO should be flashing. Select YES to prevent brewing if the water temperature is below the set READY temperature. Select NO to permit brewing at any water temperature.

When finished, press and release DONE. This will step to the next function screen. To return to the MAIN SCREEN at any time, press and release "ENABLE BREW ON/OFF".

ADJUSTMENTS & OPTIONAL SETTINGS (CONT.)

PROGRAMMING FUNCTIONS - BrewWIZARD (cont.)

The functions in the "BrewWIZARD" allow the operator to adjust brew settings and other features.

BREW OZ:

This function allows the operator to adjust the brew volume.

Procedure:

1. Press and hold the right hidden switch until the display reads "BrewWIZARD" and release.
2. The display will then read: "BREW OZ: xx.x"
3. Press (-) "**Digital**" to decrease the amount, or (+) "**Control**" to increase.
Range: (10 to 192 oz., in .5 oz. increments) or (.30 to 6.60 Liters, in .01 increments)
4. When finished, press "DONE". This will take you to the next screen. Press and release the right hidden switch to continue to the next screen, or press and release the "ENABLE BREW ON/OFF" switch to return to the main screen.

NOTE: This screen will automatically change when you do the "3 clicks" adjustment. Refer to the "MRC" card for details.



BREW METER:

This function allows the operator to adjust the brew strength/extraction time. Setting #1 will produce a **non-pulsed** brew cycle and the highest (#14) will give you the longest time (utilizing pulse brew).

Procedure:

1. Press and hold the right hidden switch until the display reads "BrewWIZARD" and release.
2. The display will then read: "BREW OZ: xx.x"
3. Press and release the right hidden switch until the display reads "BREW METER"
4. Press (-) to decrease the amount, or (+) to increase. (Range: 1 - 14)
5. When finished, press and release the right hidden switch. This will take you to the next screen, or press and release the "ENABLE BREW ON/OFF" switch to return to the main screen.

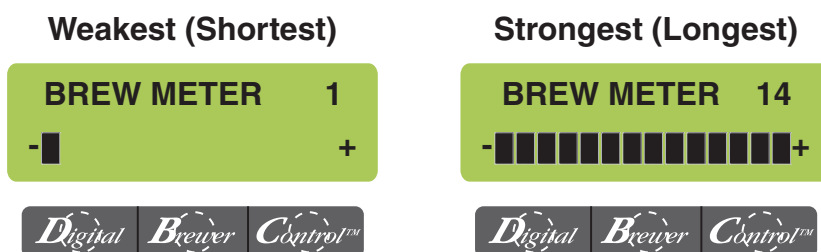

NOTE: This will overwrite settings in "PULSE BREW"

ADJUSTMENTS & OPTIONAL SETTINGS (CONT.)

SPRAY OZ/M: 25.0
(-) DONE (+)

Digital Brewer Control™

View or enter the actual flow rate coming out of the sprayhead. This is used to tell the internal controller how fast the water is flowing. Use the "CALIBRATE FLOW" screen to obtain the most current flow rate.

Range: (3.0 to 75.0 oz) or (100 to 2200ml)

CALIBRATE FLOW ?
NO YES

Digital Brewer Control™

This function provides a 60 second test mode to capture water from *each* sprayhead. This measurement will then give you the numbers to enter into the "SPRAY OZ/M: xx" screen (next) **NOTE:** Should be performed after delimiting and/or changing sprayhead.

(Will not display when "BrewLogic" is enabled)

CONTAINER READY ?
QUIT YES

Digital Brewer Control™

This function allows the operator to test and enter the actual flow rate of the sprayhead(s) for each side of the brewer by dispensing each separately for one minute. The volumes are then entered into the brewer.

WARNING: The sprayhead(s) must be installed before proceeding!

CALIBRATE SPRAY
PRESS BREW START

Digital Brewer Control™

Procedure to calibrate the sprayhead flow rate:

1. Place a container, accurately graduated with a minimum capacity of 60 ounces, under the funnel.
2. Press and hold the right hidden switch until the display reads "AXIOM - VERSION #.#". Press and release the right hidden switch until the display reads "CALIBRATE FLOW ?"
3. Select "YES". The display should read "CONTAINER READY?" If container is under the funnel, select "YES".
4. The display should read "CALIBRATE SPRAY". Press and release the "BREW" switch to begin the sprayhead flow for calibration. The display should read "CALIBRATE SPRAY...60 SEC TO FINISH. The 60-second timer on the display will count down to zero. When the counter reaches zero, the display will change to "ENTER OZ 25.0"
5. Measure the amount of water in the container and use (-) and (+) to adjust the display to the amount in the container. Then select "DONE"
6. The display should now read "NEW SPRAY FLOW" along with the correct flow rate of the sprayhead. After about 5 seconds, the display will return to the "CALIBRATE FLOW" screen.
7. To exit the "CALIBRATE FLOW" function and advance to the next screen, select NO. To exit programming and return to the MAIN SCREEN, press "ENABLE BREW ON/OFF" switch.
8. (TWINS) Repeat steps 1-7 to calibrate the other side.

ENTER OZ 25.0
(-) DONE (+)

Digital Brewer Control™

NEW SPRAY FLOW:
25.0 OZ/M

Digital Brewer Control™

ADJUSTMENTS & OPTIONAL SETTINGS (CONT.)

ENABLE ADS

This function allows the operator to choose whether or not to display an advertising message. An ad can be saved to the brewer by writing the ad using the programming commands. This message will be displayed when the brewer is idle.

Procedure to Enable/Disable Ads:

1. Press and hold the right hidden switch until the display reads "BrewWIZARD" then release. Press and release the right hidden switch until the display reads "ENABLE ADS?". The "YES" or "NO" will be flashing to indicate the current selection.
2. Press and release the "NO" switch to disable this function, or:
3. Press and release the "YES" switch to enable this function.
4. When finished, press and release "DONE" to save the new setting and advance to the next function screen.
5. If "NO" was selected, the display should now read "ENTER SERVICE #?". To exit programming and return to the MAIN SCREEN, press and release the "ENABLE BREW ON/OFF" switch.
6. If "YES" was selected, the display should now read "NEW AD?". This screen allows you to write a new ad.
7. The display should now read "2 LINES 16 CHARS AVAILABLE", and then "SCROLL THRU ALPHA, NEXT -> NEXT LETTER", and then "WRITE TOP LINE?". The ad can be up to 32 characters long, 16 per line. The ad will be written in two steps, first the top line, then the bottom line.
9. To write the top line of a new ad, press and release "YES". To skip the top line and only write a bottom line, press and release "NO" and proceed to step 13. To exit programming and return to the MAIN SCREEN, press and release the "ENABLE BREW ON/OFF" switch.
10. The display will now read "A" with a flashing cursor below it. Press and hold the "SCROLL" switch to scroll through the alphabet and available characters. When the desired character is shown on the display, press and release "NEXT" to move to the next character in the top line.
11. Repeat step 10 until the top line is complete.
12. Press and release "DONE". The display should now read "WRITE BTM LINE?".
13. To write the bottom line of the new ad, press and release "YES".
14. To skip the bottom line, press and release "NO".
 - a. If neither a top nor bottom line was written, the display should now read "ENTER SERVICE #?".
 - b. If only a top line was written, the ad will be displayed followed by "SAVE?" Proceed to step 18.
15. The display will now read A with a flashing cursor below it. Press and hold the "SCROLL" switch to scroll through the alphabet and available characters. When the desired character is shown on the display, press and release "NEXT" to move to the next character in the bottom line.
16. Repeat step 15 until the bottom line is complete.
17. Press and release "DONE". The display will now show the written ad, and then "SAVE?"
18. To cancel saving the ad, press and release "NO". The display should now read "ADVERTISEMENT NOT SAVED!" and then will return to the "NEW AD" screen. To exit programming and return to the MAIN SCREEN, press and release the "ENABLE BREW ON/OFF" switch.
19. To correct or edit the ad, press and release "EDIT". The display should now read "WRITE TOP LINE?" Repeat steps 10 through 17.
20. To save the ad as it is shown, press and release "YES". The display should now read "ADVERTISEMENT SETUP COMPLETE", and then "ENTER SERVICE #?". To exit programming and return to the MAIN SCREEN, press and release the "ENABLE BREW ON/OFF" switch.

ADJUSTMENTS & OPTIONAL SETTINGS (CONT.)

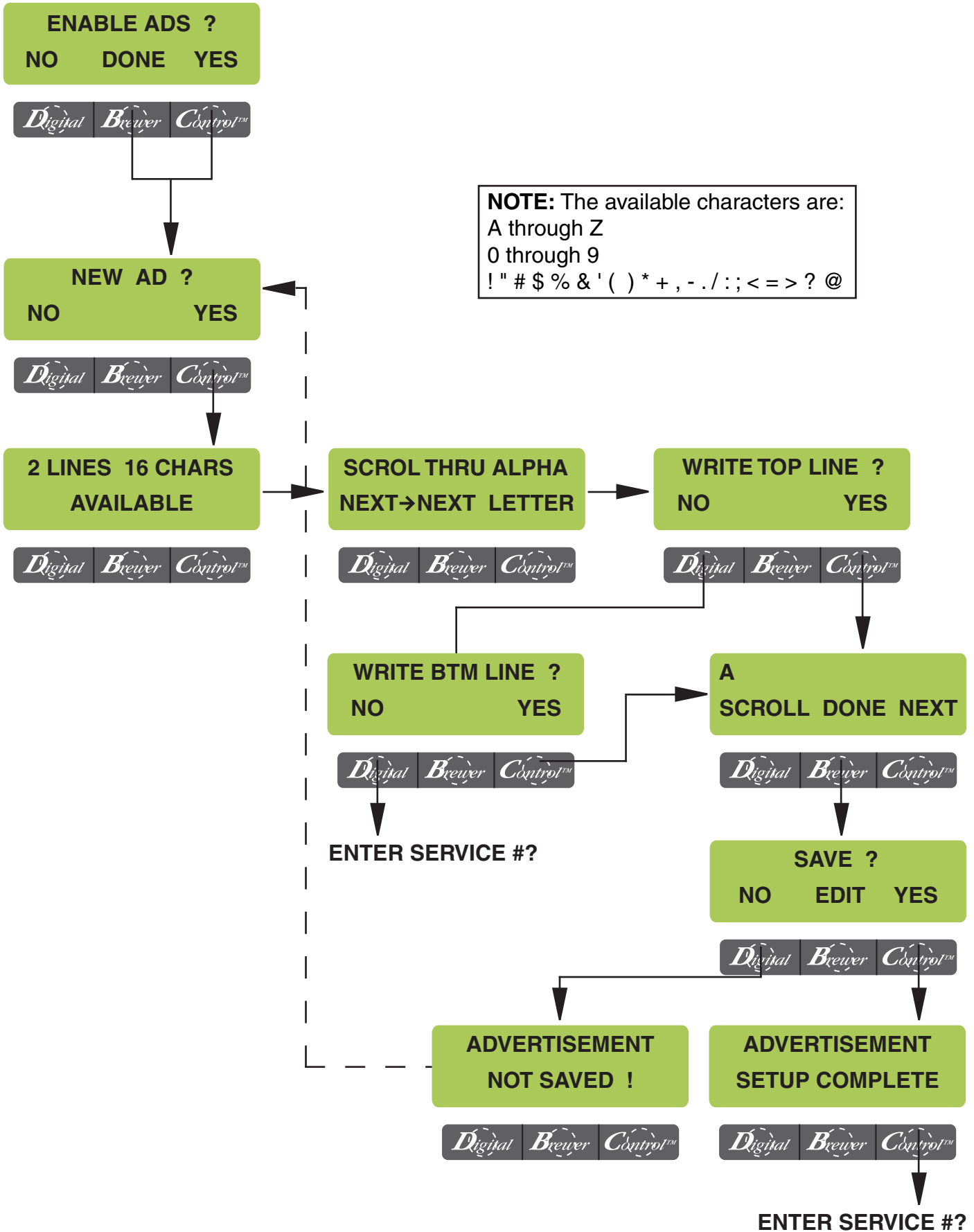

ADJUSTMENTS & OPTIONAL SETTINGS (CONT.)

SERVICE NUMBER

This function allows the operator to enter in the telephone number to call if service is needed. The service number will be displayed anytime there is a fault message displayed.

Procedure to enter the service number:

1. Press and hold the right hidden switch until the display reads "BrewWIZARD" then release. Press and release the right hidden switch until the display reads: "ENTER SERVICE #?"
2. Press and release "YES" switch. The display will now read "SCROL THRU #'S NEXT - > NEXT NUMBER", followed by "SCROLL DONE NEXT".
3. Press the "SCROLL" switch to increment the number. When the desired number is shown, press and release the "NEXT" switch to move to the next digit in the phone number.
4. Repeat Step 3 until the entire number is entered.
5. Press and release the "DONE" switch. The display will now read "EXITING BrewWIZARD" and then "ENTER PASSWORD".

PROGRAMMING FUNCTIONS - LEVEL 2

ENTER PASSWORD

This function allows the operator to enter a 3 digit number to access LEVEL 2. If no number has been pre programmed (0 0 0), then access is allowed by pressing and releasing the right hidden switch.

Procedure to enter the "PASSWORD":

1. Press and release the "**Digital**" switch to increment the first digit.
2. Press and release the "**Brewer**" switch to increment the second digit.
3. Press and release the "**Control**" switch to increment the third digit.
4. Press and release the right hidden switch. If the correct password was entered, the display will now read "SET PASSWORD". If the wrong password was entered, the unit will revert back to the main screen.

ENTER SERVICE #?
NO YES

Digital Brewer Control™

SCROL THRU #'s
NEXT→NEXT NUMBER

Digital Brewer Control™

̄SCROLL DONE NEXT

Digital Brewer Control™

EXITING
BrewWIZARD

Digital Brewer Control™

ENTER PASSWORD

0 0 0

Digital Brewer Control™



ADJUSTMENTS & OPTIONAL SETTINGS (CONT.)

PROGRAMMING FUNCTIONS - LEVEL 2 (cont.)

NOTE: Access to the remaining functions in LEVEL 2 is intended for trained service personnel only. More in depth information can be found in the **Axiom Service Manual** 39132.0000

SET PASSWORD
0 0 0

Digital Brewer Control™

Any 3 digit number may be programmed to prevent unauthorized access of LEVEL 2. **BE CAREFUL TO USE A CODE YOU WILL REMEMBER!**

SET LANGUAGE
NO YES

Digital Brewer Control™

Choose between English or Spanish. After selecting "YES", press either (+) or (-) to select, then choose "YES" again when asked, "ARE YOU SURE?"

UNITS
METRIC DONE ENG

Digital Brewer Control™

Choose between English or Metric units. Display will read: "CHANGING UNITS WILL CAUSE" "ALL SETUP INFO TO BE LOST" "ARE YOU SURE?" "NO YES". **NOTE:** If the brewer is set for Metric Units, displays will be different. (ex: Brew oz will become Brew milliliters, ° F will be ° C).

SET TEMP: 200°
(-) DONE (+)

Digital Brewer Control™

Adjusts brew tank temperature.
RANGE: (185 to 205° F) or (85 to 96° C)

SET READY: 195°
(-) DONE (+)

Digital Brewer Control™

This function sets the minimum temperature allowable to start a brew cycle. Range: (2° to 20° F) or (2° to 10° C) below the set temperature. The water must be at the "READY" temperature or higher for the display to indicate "READY TO BREW".

ENTER ASSET # ?
NO YES

Digital Brewer Control™

This function allows the you to enter in an optional asset number. This can be useful for tracking the usage or service of an individual machine within a group.

SET PULSE BREW ?
NO YES

Digital Brewer Control™

This function allows the sprayhead to "pulse" on and off during a brew cycle. These times can be set two different ways. The first is by setting the total brew time in the "EASY PULSE BREW" screen. The other option allows the actual times to be entered in the "MANUAL PULSE BREW" screen.

NOTE: This will overwrite settings in "BREW METER".

ADJUSTMENTS & OPTIONAL SETTINGS (CONT.)

PROGRAMMING FUNCTIONS - LEVEL 2 (cont.)



"EASY PULSE BREW" times:

Min: Base brew time + 40 seconds

Max: Base brew time + 3:00 minutes

DRIP TIME 1:00
 (-) **DONE** (+)

Digital Brewer Control™

Adjusts the DRIP TIME (time from end of sprayhead flow to when liquid stops dripping from the funnel). When the brew cycle is complete, the display will show "DRIPPING" and will countdown the time until the funnel empties.

RANGE: "OFF" or 0:05 to 4:00 minutes

ENABLE CLEAN
 NO **DONE** YES

Digital Brewer Control™

Set the time before a cleaning alert will be displayed.

RANGE: 1 to 30 days

Enabl EnergySavr
 NO **DONE** YES

Digital Brewer Control™

When enabled, sets the idle and wake times. Then choose to have the tank heater(s) turn off, or reduce the tank temp to (140° F) or (60° C). Ex: idle = 6:00PM - wake = 6:00AM.

0 REFILL 155
 (-) **DONE** (+)

Digital Brewer Control™

Adjusts the sensitivity of the refill circuit. Water in different geographical locations can have different conductivities. Make sure the water in the tank is touching the refill probe. **NOTE:** Always make sure that the # on the right is larger than the # on the left when water is contacting the tank refill probe.

ENABLE BrewLOGIC
 NO **DONE** YES

Digital Brewer Control™

The BrewLogic system allows the brewer to be calibrated to high mineral locations and compensate as deposits build up internally. Press YES, then press DONE. Follow the prompts.

Go to
 SPRAY OZ/M:

**PLACE BREWER IN
 FINAL LOCATION**

Digital Brewer Control™

Select a sturdy, level location.

Brewer must not be bumped during calibration!

(CONT.)

ADJUSTMENTS & OPTIONAL SETTINGS (CONT.)

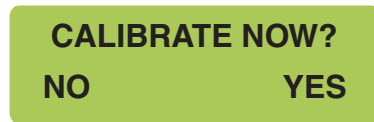

Select YES for calibration. Selecting NO warns of accuracy risk

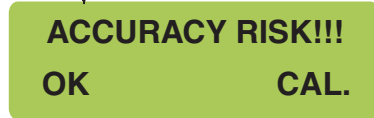

Select CAL. to start calibration procedure. Selecting OK will skip to level probe calibration screen.

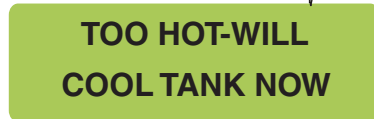

Automatically checks to see if tank temperature is between 130°-170°F (54°-76°C)

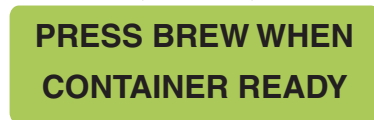

Verify brew funnel and decanter/thermal server (depending on which model you have) are in place. Then press the "BREW START" button.

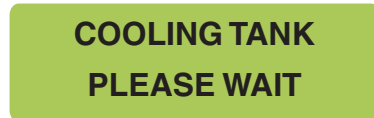

Message will be displayed while dispense is being performed. Tank heaters are turned off and the unit will dispense for ~1 minute to cool tank temperature.

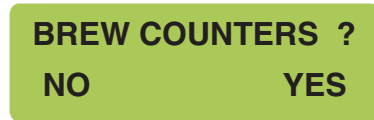

Tracks the total number of brew cycles completed. There is one reset-able counter, and one life counter that is not reset-able

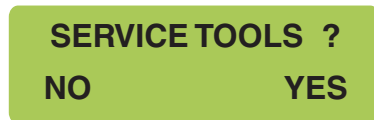

Allows the testing of individual components and the ability to check the membrane switches for proper function. (Diagnostic tool for troubleshooting purposes only)

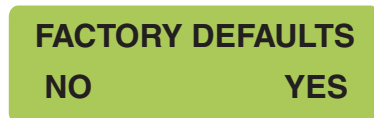

Reset ALL of the previously entered brew settings, ad message, calibrations, etc. Factory-set default values will replace ALL previous settings.

NOTE: Items not affected; Service #, Password, Language, Units, Asset #, Counters and Serial Number.



BrewWISE PROGRAMMING

PROGRAMMING THE BREWER

The information in this manual covers only the differences between this model and the standard Axiom. Access to service level 4 is same as standard Axiom. The following function screens are in order of appearance. Each screen will have instructions on how to access, and the procedures to program the various functions of the brewer.

IMPORTANT PROGRAMMING NOTES

- READ CAREFULLY -

To exit the programming mode at any time, press and release "ENABLE BREW ON/OFF" switch located on the front switch panel. The display will return to the MAIN SCREEN.

If none of the programming switches are pressed within one minute during the setup of the brewer, the programming of the function screen that is being set will be exited and the display will return to the MAIN SCREEN.

Always remember to place an empty server and funnel under the sprayhead when operating the brewer during the set-up of PULSE BREW, CALIBRATE FLOW and testing the brew valve in TEST OUTPUTS.

PROGRAMMING LOCKOUT SWITCH (Mounted on main control board)

This switch can be set to prevent access to the programming settings of the brewer. Once all the correct brew settings are programmed, the operator can set the switch to the "LOCK" position to prohibit anyone from changing the settings. With the switch in the "LOCK" position, the programming menus can still be accessed to view the current settings. However, no changes will be saved.



Disconnect brewer from power source before removing any panel!

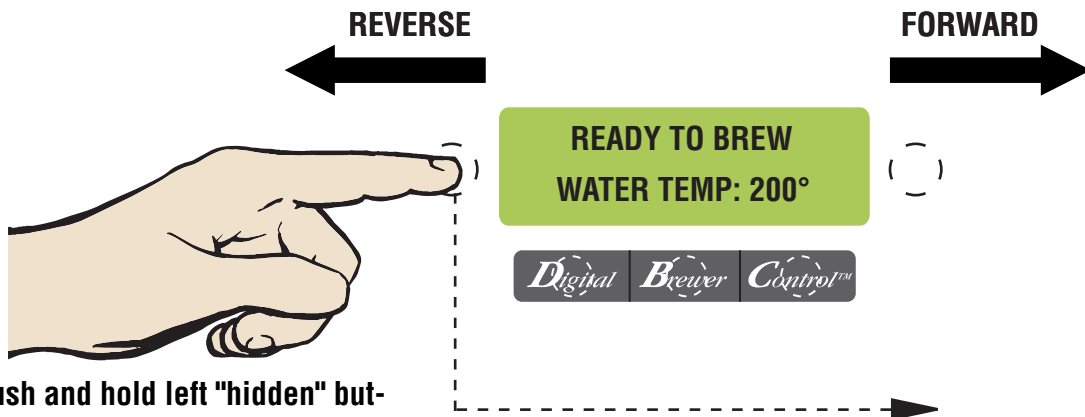
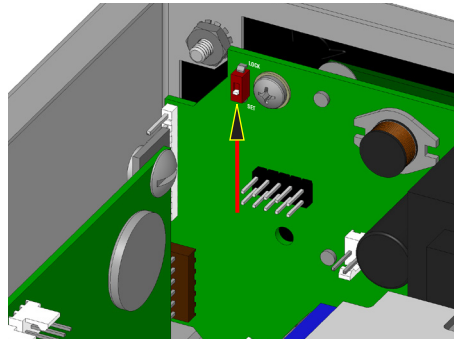

Push and hold left "hidden" button to access service program modes.

BrewWISE PROGRAMMING

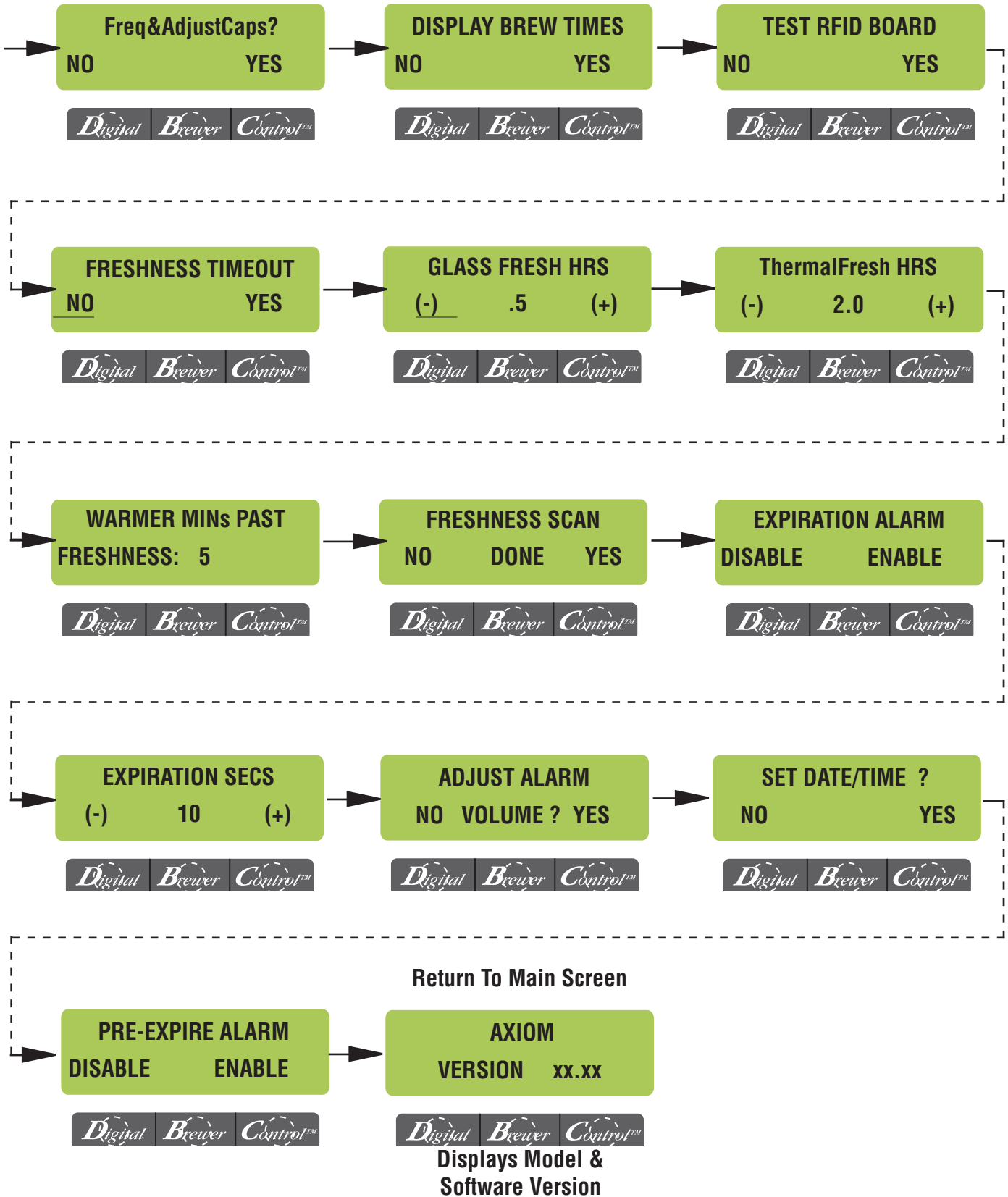

BrewWISE PROGRAMMING

Freq&AdjustCaps?
NO YES

Digital Brewer Control™

125.0 0000 * TOP F
125.0 0000 * TOP R

Digital Brewer Control™

125.0 0000 * MAIN

Digital Brewer Control™

DISPLAY BREW TIMES
NO YES

Digital Brewer Control™

MAY 10 2010
MAIN 10:00:00 AM

Digital Brewer Control™

TEST RFID BOARD
NO YES

Digital Brewer Control™

RFID CIRCUIT BOARD
VERSION # xx.xx

Digital Brewer Control™

This allows you to monitor the frequency of the warmer(s) sensing coils.

Also allows you to monitor the adjustment capacitors, which are used to keep the coil frequency at it's nominal value (125.0 khz)

Use the "Brewer" button to toggle between screens.

Press right hidden button to advance to next function.

This allows you to read the "age" of any brewed batch in a particular carafe (as long as it is equipped with an RFID chip). The sensor coil will read the chip and brewer will display time of day it was brewed.

This screen will automatically scroll through all warmers.

Press right hidden button to advance to next function.

This allows you to monitor individual sensing coils and RFID board.

CONTINUED

BrewWISE PROGRAMMING

**PRESS ANY SWITCH
TO EXIT**

Digital Brewer Control™

10:00:00 AM

M TF TR

Digital Brewer Control™

GLASS FRESH HRS

(-) .5 (+)

Digital Brewer Control™

ThermalFresh HRS

(-) 2.0 (+)

Digital Brewer Control™

WARMER MINs PAST

FRESHNESS: 5

Digital Brewer Control™

FRESHNESS SCAN

NO DONE YES

Digital Brewer Control™

EXPIRATION ALARM

DISABLE ENABLE

Digital Brewer Control™

If a carafe is placed on a particular warmer, a "box" will appear next to it's indicator. If the box is filled (solid) it's not expired yet. If the box is empty, the time is expired. See example: MAIN = expired; Top Front = not expired; Top Rear = expired.

Press right hidden button to advance to next function.

Enables the "FRESHNESS ALERT!" message and sets the expiration time. The expiration time is the amount of time the product is allowed to sit in the glass decanter before an alert message is displayed. DEFAULT: .5

Range: OFF/0.5 - 4.0 hrs

Enables the "FRESHNESS ALERT!" message and sets the expiration time. The expiration time is the amount of time the product is allowed to sit in the thermal server before an alert message is displayed. DEFAULT: 2.0

Range: OFF/0.5 - 4.0 hrs

Sets the amount of time the warmers will turn off after an alert message is displayed. DEFAULT: 5

Range: OFF/1 - 30 min

Allows brewer to continually scan the warmer sensor coils and display freshness times.

Enable/Disable beeper.

CONTINUED

BrewWISE PROGRAMMING

EXPIRATION SECS
(-) 10 (+)

Digital Brewer Control™

Sets the amount of delay between alarm beeps.

ADJUST ALARM
NO VOLUME ? YES

Digital Brewer Control™

Select "YES" to adjust beeper volume.

ADJUST ALARM 5
- [|||||] [|||||] [|||||] +

Digital Brewer Control™

Press "+" to increase volume, or "-" to decrease.

SET DATE/TIME ?
NO YES

Digital Brewer Control™

Select "YES" to set date and/or time.

YEAR 2010
(-) DONE (+)

Digital Brewer Control™

Press "+" to scroll year forward, or "-" to scroll year back.

MONTH MAY
(-) DONE (+)

Digital Brewer Control™

Press "+" to scroll month forward, or "-" to scroll month back.

DAY 10
(-) DONE (+)

Digital Brewer Control™

Press "+" to scroll day forward, or "-" to scroll day back.

CONTINUED

BrewWISE PROGRAMMING

HOUR 10 AM
(-) **DONE** (+)

Digital *Brewer* *Control™*

MINUTE 00
(-) **DONE** (+)

Digital *Brewer* *Control™*

SECOND 00
(-) **DONE** (+)

Digital *Brewer* *Control™*

PRE-EXPIRE ALARM
DISABLE **ENABLE**

Digital *Brewer* *Control™*

EXIT

Press "+" to scroll hour forward, or "-" to scroll hour back.

Press "+" to scroll minute forward, or "-" to scroll minute back.

Press "+" to scroll seconds forward, or "-" to scroll seconds back.

Enable/disable the 5 minute warning beep for a carafe about to expire.