

BUNN®

LCA-2 LP

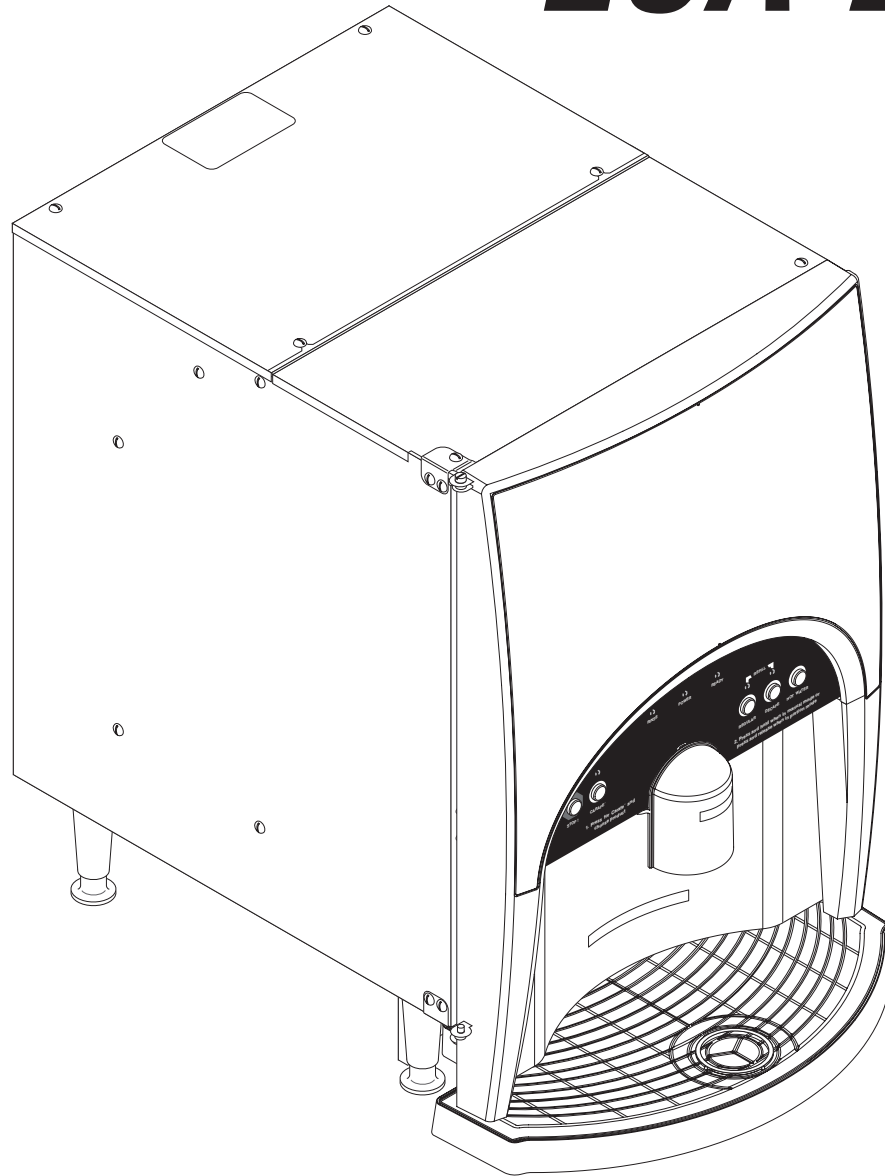

INSTALLATION & OPERATING GUIDE

BUNN-O-MATIC CORPORATION

POST OFFICE BOX 3227

SPRINGFIELD, ILLINOIS 62708-3227

PHONE: (217) 529-6601 FAX: (217) 529-6644

To ensure you have the latest revision of the Operating Manual, or to view the Illustrated Parts Catalog, Programming Manual, or Service Manual, please visit the Bunn-O-Matic website, at www.bunn.com. This is absolutely FREE, and the quickest way to obtain the latest catalog and manual updates. For Technical Service, contact Bunn-O-Matic Corporation at 1-800-286-6070.

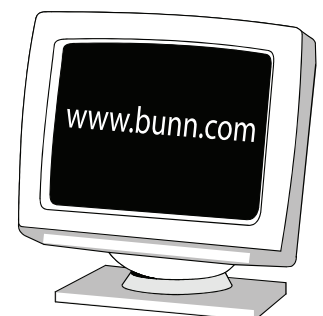

BUNN-O-MATIC COMMERCIAL PRODUCT WARRANTY

Bunn-O-Matic Corp. ("BUNN") warrants equipment manufactured by it as follows:

- 1) Airpots, thermal carafes, decanters, GPR servers, iced tea/coffee dispensers, MCR/MCP/MCA single cup brewers, thermal servers and ThermoFresh® servers (mechanical and digital) 1 year parts and 1 year labor.
- 2) All other equipment - 2 years parts and 1 year labor plus added warranties as specified below:
 - a) Electronic circuit and/or control boards - parts and labor for 3 years.
 - b) Compressors on refrigeration equipment - 5 years parts and 1 year labor.
 - c) Grinding burrs on coffee grinding equipment to grind coffee to meet original factory screen sieve analysis - parts and labor for 4 years or 40,000 pounds of coffee, whichever comes first.

These warranty periods run from the date of installation BUNN warrants that the equipment manufactured by it will be commercially free of defects in material and workmanship existing at the time of manufacture and appearing within the applicable warranty period. This warranty does not apply to any equipment, component or part that was not manufactured by BUNN or that, in BUNN's judgment, has been affected by misuse, neglect, alteration, improper installation or operation, improper maintenance or repair, non periodic cleaning and descaling, equipment failures related to poor water quality, damage or casualty. In addition, the warranty does not apply to replacement of items subject to normal use including but not limited to user replaceable parts such as seals and gaskets. This warranty is conditioned on the Buyer 1) giving BUNN prompt notice of any claim to be made under this warranty by telephone at (217) 529-6601 or by writing to Post Office Box 3227, Springfield, Illinois 62708-3227; 2) if requested by BUNN, shipping the defective equipment prepaid to an authorized BUNN service location; and 3) receiving prior authorization from BUNN that the defective equipment is under warranty.

THE FOREGOING WARRANTY IS EXCLUSIVE AND IS IN LIEU OF ANY OTHER WARRANTY, WRITTEN OR ORAL, EXPRESS OR IMPLIED, INCLUDING, BUT NOT LIMITED TO, ANY IMPLIED WARRANTY OF EITHER MERCHANTABILITY OR FITNESS FOR A PARTICULAR PURPOSE. The agents, dealers or employees of BUNN are not authorized to make modifications to this warranty or to make additional warranties that are binding on BUNN. Accordingly, statements by such individuals, whether oral or written, do not constitute warranties and should not be relied upon.

If BUNN determines in its sole discretion that the equipment does not conform to the warranty, BUNN, at its exclusive option while the equipment is under warranty, shall either 1) provide at no charge replacement parts and/or labor (during the applicable parts and labor warranty periods specified above) to repair the defective components, provided that this repair is done by a BUNN Authorized Service Representative; or 2) shall replace the equipment or refund the purchase price for the equipment.

THE BUYER'S REMEDY AGAINST BUNN FOR THE BREACH OF ANY OBLIGATION ARISING OUT OF THE SALE OF THIS EQUIPMENT, WHETHER DERIVED FROM WARRANTY OR OTHERWISE, SHALL BE LIMITED, AT BUNN'S SOLE OPTION AS SPECIFIED HEREIN, TO REPAIR, REPLACEMENT OR REFUND.

In no event shall BUNN be liable for any other damage or loss, including, but not limited to, lost profits, lost sales, loss of use of equipment, claims of Buyer's customers, cost of capital, cost of down time, cost of substitute equipment, facilities or services, or any other special, incidental or consequential damages.

392, A Partner You Can Count On, Air Infusion, AutoPOD, AXIOM, BrewLOGIC, BrewMETER, Brew Better Not Bitter, BrewWISE, BrewWIZARD, BUNN Espresso, BUNN Family Gourmet, BUNN Gourmet, BUNN Pour-O-Matic, BUNN, BUNN with the stylized red line, BUNNlink, Bunn-O-Matic, Bunn-O-Matic, BUNNserve, BUNNSERVE with the stylized wrench design, Cool Froth, DBC, Dr. Brew stylized Dr. design, Dual, Easy Pour, EasyClear, EasyGard, FlavorGard, Gourmet Ice, Gourmet Juice, High Intensity, iMIX, Infusion Series, Intellisteam, My Café, Phase Brew, PowerLogic, Quality Beverage Equipment Worldwide, Respect Earth, Respect Earth with the stylized leaf and coffee cherry design, Safety-Fresh, savemycoffee.com, Scale-Pro, Silver Series, Single, Smart Funnel, Smart Hopper, SmartWAVE, Soft Heat, SplashGard, The Mark of Quality in Beverage Equipment Worldwide, ThermoFresh, Titan, trifacta, TRIFECTA (stylized logo), Velocity Brew, Air Brew, Beverage Bar Creator, Beverage Profit Calculator, Brew better, not bitter., Build-A-Drink, BUNNSource, Coffee At Its Best, Cyclonic Heating System, Daypart, Digital Brewer Control, Element, Milk Texturing Fusion, Nothing Brews Like a BUNN, Picture Prompted Cleaning, Pouring Profits, Signature Series, Sure Tamp, Tea At Its Best, The Horizontal Red Line, Ultra are either trademarks or registered trademarks of Bunn-O-Matic Corporation. The commercial trifacta® brewer housing configuration is a trademark of Bunn-O-Matic Corporation.

CONTENTS

Warranty	2
User Notices	4
Introduction	5
Electrical Requirements	5
Plumbing Requirements	5
Initial Set-up	6
Electrical Hook-up.....	6
Plumbing Hook-up.....	6
Operating Controls & Interface	7
Installing Pump Tubing	9
Initial Fill & Heat.....	10
Rinse Alarm Feature.....	11
Programming the Dispenser	12
Priming the Concentrate Lines.....	16
Draining the Hot Water.....	16
Operating the Dispenser.....	17
Cleaning & Preventive Maintenance.....	18
Replacing the Pump Tubing	19
Calibrating the Dispenser	20
Troubleshooting Guide	22
Field Calibration of the Concentrate Pumps	24
Dispenser Flow Rate Calibration	24
Field Calibrating the Empty Product Warning.....	25
Schematic Wiring Diagrams.....	26

USER NOTICES

Carefully read and follow all notices on the equipment and in this manual. They were written for your protection. All notices are to be kept in good condition. Replace any unreadable or damaged labels.

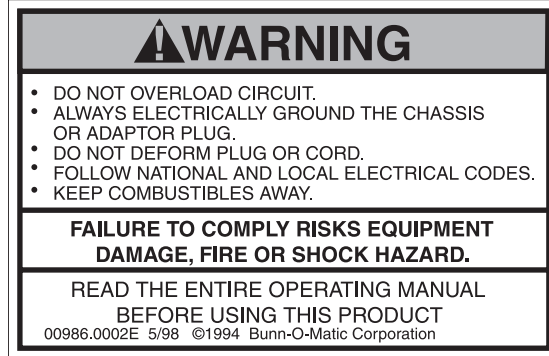

00986.0002

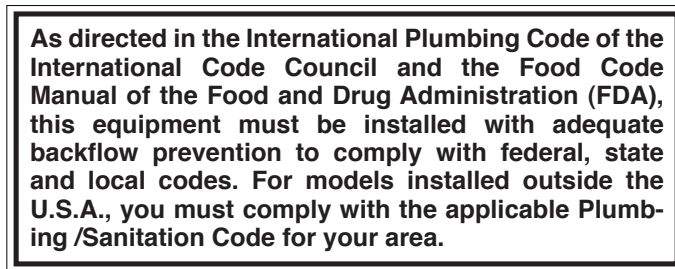

00656.0001

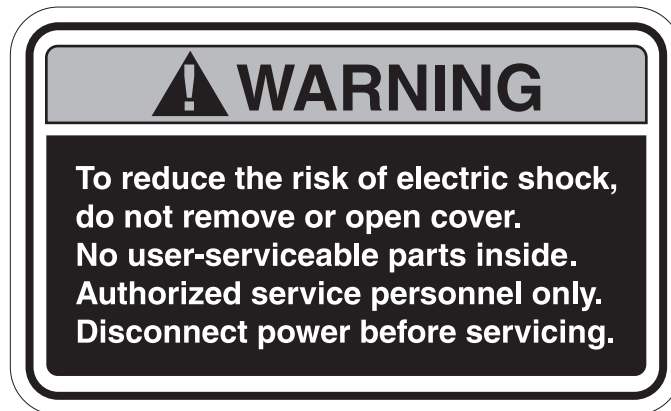

37881.0000



11646.0002



00824.0002

INTRODUCTION

The Liquid Coffee Ambient Dispenser delivers two types of coffee made from liquid concentrate plus hot water. The dispenser can be set up for continuous draw (by the cup) for self-serve applications, or portion-control to fill carafes and decanters for wait staff. Follow the Concentrate Manufacturer's Storage and Shelf Life recommendations.

This dispenser is designed to operate when ambient temperatures are from 32°F (0°C) minimum to 104°F (40°C) maximum.

ELECTRICAL REQUIREMENTS

WARNING - If the power cord is ever damaged, it must be replaced by the manufacturer or its service agent with a special cord available from the manufacturer or its service agent in order to avoid a hazard.

The LCA-2 LP dispenser is supplied with a 120-volt / 15 Amp cord set and require a 2-wire, grounded, individual branch circuit rated for 120 volts AC, 15 amp, single phase, 60Hz. The mating connector must be a NEMA 5-15R.

PLUMBING REQUIREMENTS

The dispenser may be connected to a cold or hot water system (140°F Max.) with operating pressure between 20 and 90 psi (0.138 and 0.620 MPa) from a 3/8" or larger supply line. A shut-off valve should be installed in the line before the dispenser. Install a regulator in the line when pressure is greater than 90 psi (0.620 MPa) to reduce it to 50 psi (0.345 MPa). The water inlet fitting is 1/4" flare. Dispensers set up to deliver to 50.0 ml/sec (1.7 Oz./sec.) and require a water supply source that can deliver a minimum of 1.0 gpm (3.8 lpm) at the inlet fitting. NOTE: Bunn-O-Matic recommends 1/4" tubing from the 3/8" water supply line. At least 18 inches of FDA approved flexible beverage tubing, such as reinforced braided polyethylene or silicone, before the dispenser will facilitate movement to clean the counter top. It can be purchased direct from Bunn-O-Matic (part number [00326.0000](#)). Bunn-O-Matic does not recommend the use of a saddle valve to install the dispenser. The size and shape of the hole made in the supply line by this type of device may restrict water flow.

As directed in the International Plumbing Code of the International Code Council and the Food Code Manual of the Food and Drug Administration (FDA), this equipment must be installed with adequate backflow prevention to comply with federal, state and local codes. For models installed outside the U.S.A., you must comply with the applicable Plumbing /Sanitation Code for your area.

NOTE - Water pipe connections and fixtures directly connected to a potable water supply shall be sized, installed and maintained in accordance with federal, state and local codes.

BUNN recommends the use of our Easy Clear® Water Quality Systems to assure perfect taste.

Filter Kit - Easy Clear EQHP10L Bunn-O-Matic part no. 39000.0001

INITIAL SET-UP

NOTE: The LCA-2 LP weighs approximately 70 lbs. (32 kg). If necessary, use more than one person when lifting or moving the dispenser.

1. Cut the plastic bands and remove the top box.
2. Locate and remove the parts box from top of packaging and set aside.
3. Remove foam packing.
4. Set dispenser on the counter where it is to be used. **CAUTION: DO NOT LIFT ON THE DOOR.**
5. Open the parts box remove the drip tray, brackets and splash guard.
6. Install the drip tray assembly.
 - a. Loosen the front two legs several turns.
 - b. Slide the drip tray brackets between the large washers and the base plate.
 - c. Retighten the two front legs securing the bracket.
 - d. Install the drip tray.



7. Install the splash guard panel.
 - a. Insert the top tabs into the slots on the door panel.
 - b. Align the key hole slots over the two lower screws, then slide the splash guard down.
 - c. Tighten the two lower screws.
8. Level the dispenser using the adjustable feet on the legs.



PLUMBING HOOK-UP (Early Models)

1. Securely attach the short piece of tubing and the water strainer assembly to the inlet fitting on the bottom of the dispenser.
2. Flush the water line to remove any debris or foreign material, and securely attach it to the flare fitting on the water strainer assembly.
3. Turn on the water supply and check for leaks.



PLUMBING HOOK-UP (Late Models)

1. Remove the flare elbow fitting from the parts box. Remove the shipping cap from the inlet valve on the bottom of the dispenser and attach the elbow fitting securely to the valve.
2. Flush the water line to remove any debris or foreign material, and securely attach it to the inlet fitting.
3. Turn on the water supply and check for leaks.



ELECTRICAL HOOK-UP

CAUTION: Improper electrical installation will damage electronic components.

1. An electrician must provide electrical service as specified in conformance with all local, state and federal electrical codes.
2. Using a voltmeter, check the voltage and color-coding of each conductor at the electrical source.
3. Connect the dispenser to the power source.
4. If plumbing is to be hooked up later, be sure the dispenser is disconnected from the power source. If plumbing has been hooked up, the dispenser is ready for Initial Fill & Heat.

OPERATING CONTROLS AND INTERFACE

1. Dispense Switches: Push to dispense product.
2. Stop Switch: Momentary switch stops all dispense functions.
3. Hot Water Switch: Push and Hold switch to dispense hot water from the center dispense tip.
4. Carafe Switch: Momentarily pushed to select the Carafe dispense Volume.
5. Power LED: Red - illuminates when AC power is applied to dispenser.
6. Ready LED: Green - illuminates when the water is at the preset ready temperature.
7. Carafe LED: Yellow - illuminates when the portion dispense option has been selected, (5 second delay).
8. Rinse LED: Yellow - illuminates when the optional preset rinse alarm time has elapsed.
9. Left Refill LED: Yellow - illuminates when the Left Concentrate Can needs replaced.
10. Right Refill LED: Yellow - illuminates when the Right Concentrate Can needs replaced.
11. Function Selector Switch: Allows the user to select different dispensing functions. (*Located behind the splash guard panel*)
 - a. Rinse: Dispenses hot water only- Flushes the mix chamber and dispense tip.
 - b. Prime: Dispenses concentrates only – Primes the concentrate pump.
 - c. Normal: Normal dispense mode - Dispenses mixed product (concentrate and water).
12. Mode Selector Switch: Allows the user to select different operating modes.
 - a. Run: Normal operating position.
 - b. Night: Anti-pilfering mode that disables dispensing, but keeps heater and chiller operational.

WARNING - The NIGHT Mode does not remove AC power from the dispenser. Disconnect power source before servicing the dispenser.

 - c. Program: Enables programming and set up of the dispenser.
13. Programming Switches: Used in conjunction with the LED display to program and calibrate the dispenser to customer specific requirements.
 - a. MENU: used to scroll to the next menu screen.
 - b. (+): used to increase the displayed value.
 - c. (-): used to decrease the displayed value.
14. LED Display: Displays programming menus and fault messages.

(Continued Next Page)

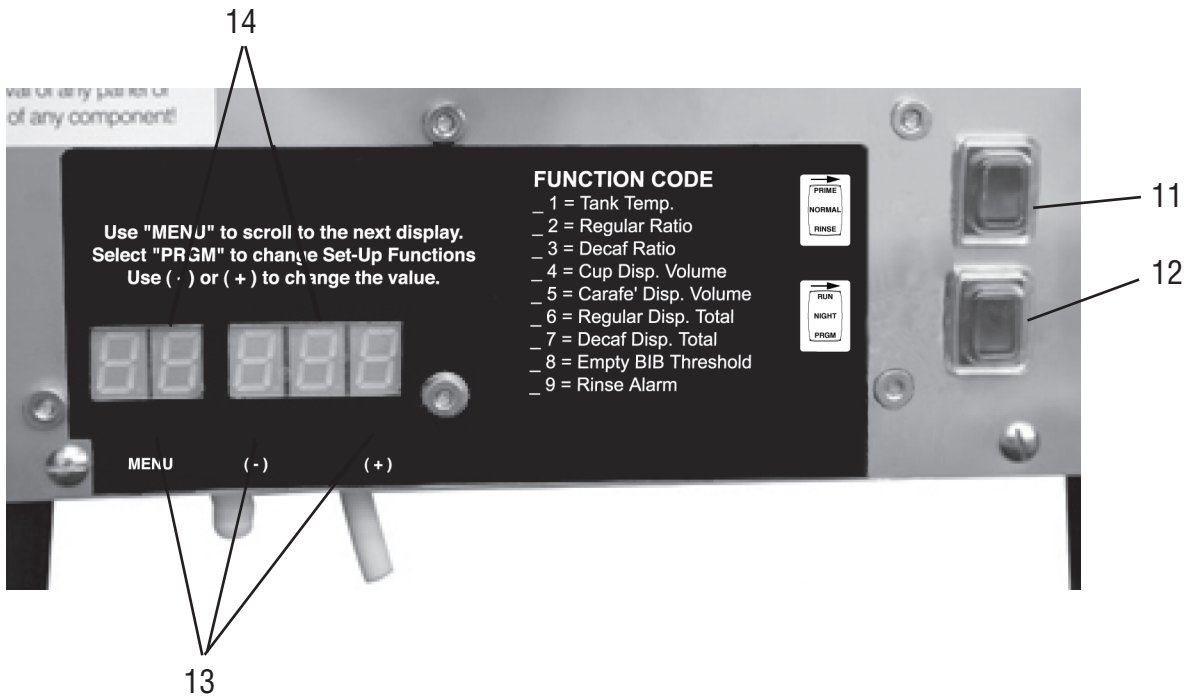
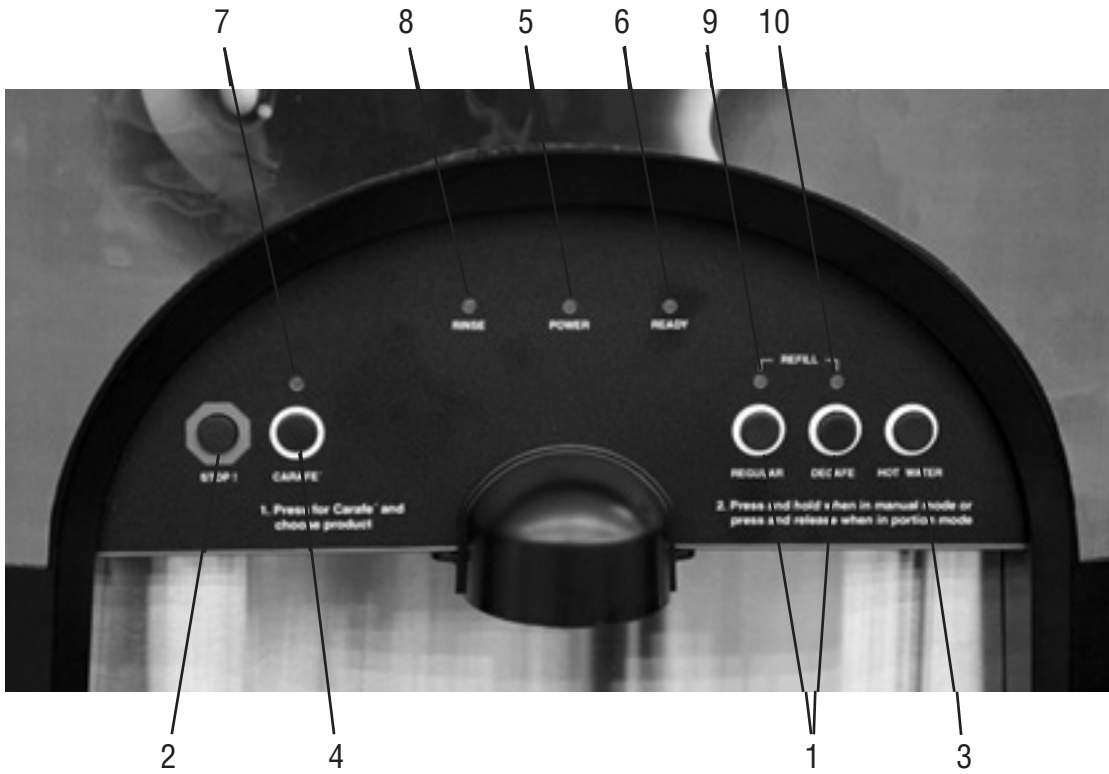

INSTALLING PUMP TUBING

INSTALLING THE PUMP TUBING

Refer to the *Tube Replacement Instruction* inside the Cabinet door.

1. Loosen the thumbscrew securing the tubing retainer plate to the pump body and set the retainer plate aside.
2. Depress the tension screw and remove it from the notch in the pump body, releasing the spring tension on the pump band.
3. Apply lubricant (BUNN-O-MATIC part no. [M2531.0001](#)) to the middle section of the new pump tubing.
4. Carefully wrap the new tubing around the rotor, making sure that the elbow and clamps end up on the front side of the pump body.
5. Depress the tension screw and insert it in the notch in the pump body, reapplying spring tension on the pump band.
6. Install the free end of the tube over the inlet port of the mix chamber on that side of the cabinet.
7. Replace the tubing retainer plate and tighten the thumbscrew.
8. Open the product container and insert the stainless steel drawtube into the container.
9. Repeat steps 1 through 8 for the other pump.

Note: Replacement Tube Kits can be purchased from BUNN-O-MATIC. Order part no. [37942.1000](#)

10. Prime the pumps. Refer to *Priming the Concentrate Lines* section.

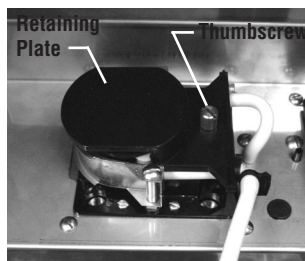

Remove Retaining Plate

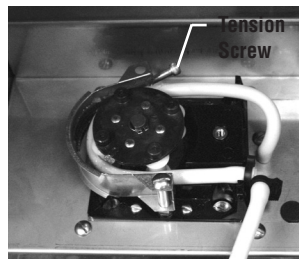

Release Spring Tension



Remove Tubing

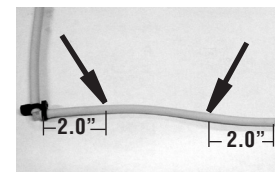

Lubricate between arrows

Lubricate New Tube

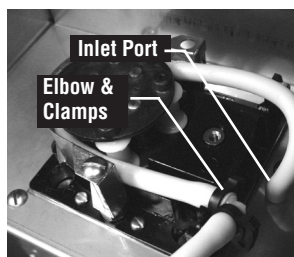

Install New Tubing



Completed Installation

INITIAL FILL & HEAT

1. Select **Normal** on the Function Selector Switch and **Run** on the Mode Selector Switch.
2. Confirm the water supply is on.
3. Connect the dispenser to the power source. The Red POWER LED will illuminate and water will begin flowing into the tank. The dispenser will automatically stop filling when the tank is full. The dispenser will not begin heating the water until after the tank is filled.
4. The Green READY LED will illuminate when the tank temperature reaches the preset ready temperature.

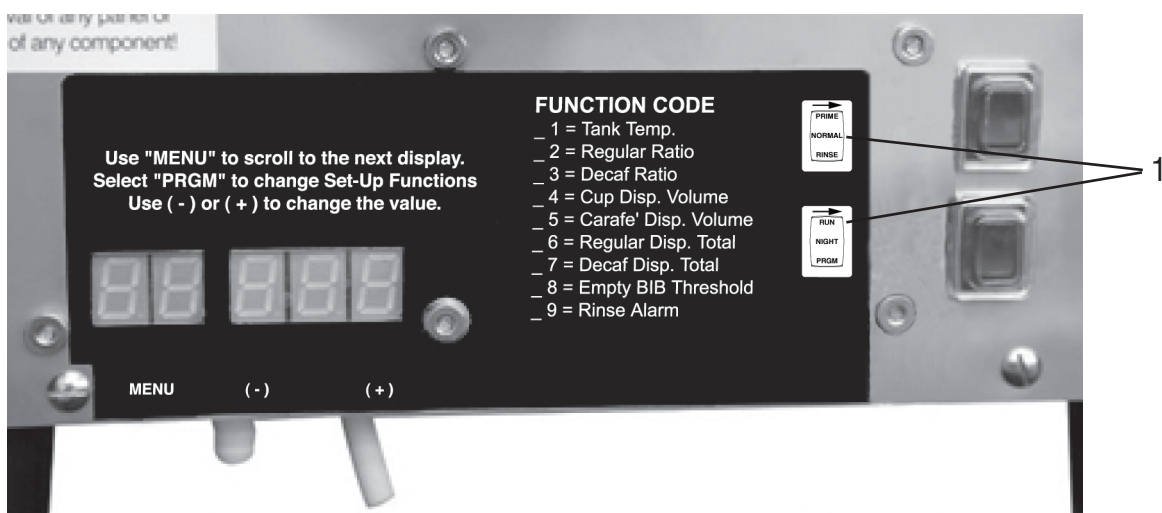
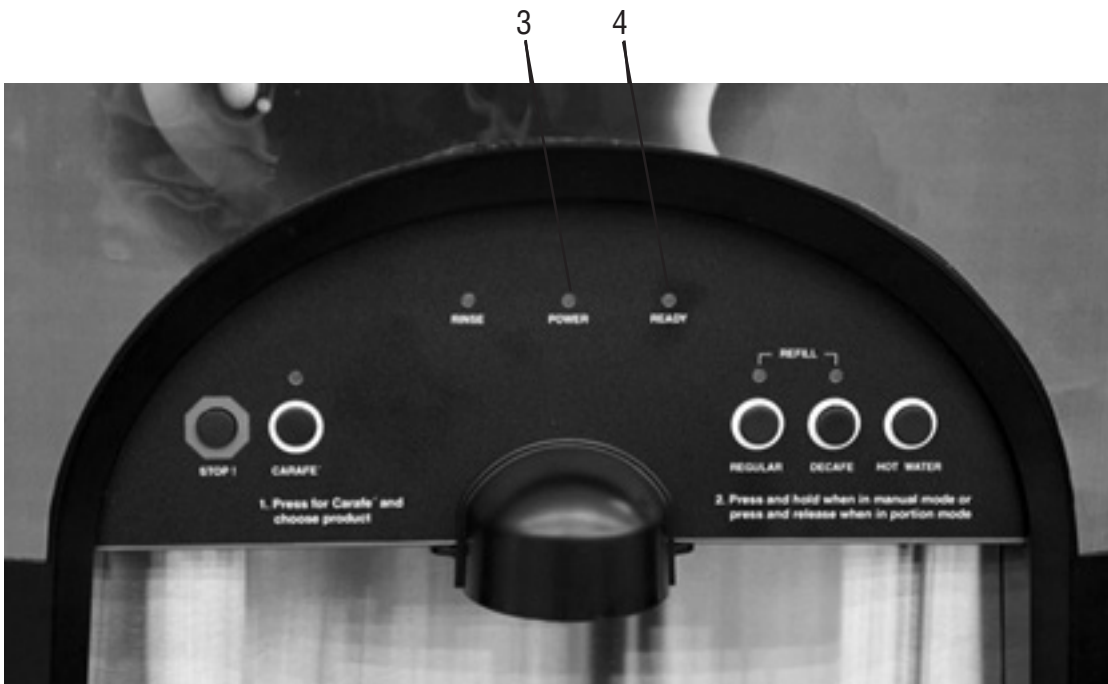

Rinse Alarm Feature

Periodic rinsing of the mix chambers and dispense tips is essential for proper maintenance and optimum performance of the dispenser. The automated Rinse Alarm feature has two levels of operation, Disabled and Warning.

Alarm Level Selected

Disabled

Warning

Alarm Mode

None

Rinse LED will come on 4 hrs prior to the selected time interval and remain on until the Rinse procedure has been performed. The dispenser will continue to serve product.

NOTE: The time interval between Rinses is adjustable from 0 to 24 hrs.

The dispenser is shipped with the automated Rinse Alarm disabled, (No Alarm). It is up to the user to determine the Rinse time interval and the level of warning required, based on their application and maintenance procedures. To enable the automated Rinse Alarm feature, refer to RINSE ALARM in *Programming the Dispenser*.

Rinse Procedure:

1. Open the cabinet door and select **Rinse** on the Function Selector switch – close the door.
2. Place a 2 Liter (1/2 Gal) container under the Left dispense tip.
3. Press and hold the Left dispenser until water flow stops automatically, approximately 20 sec.
4. Repeat Steps 2 & 3 for the Right dispense tip.

NOTE: The Rinse LED will turn OFF, when the Rinse procedure has been satisfied for both sides.

5. Open the cabinet door and select **Normal** on the Function Selector switch – close the door.

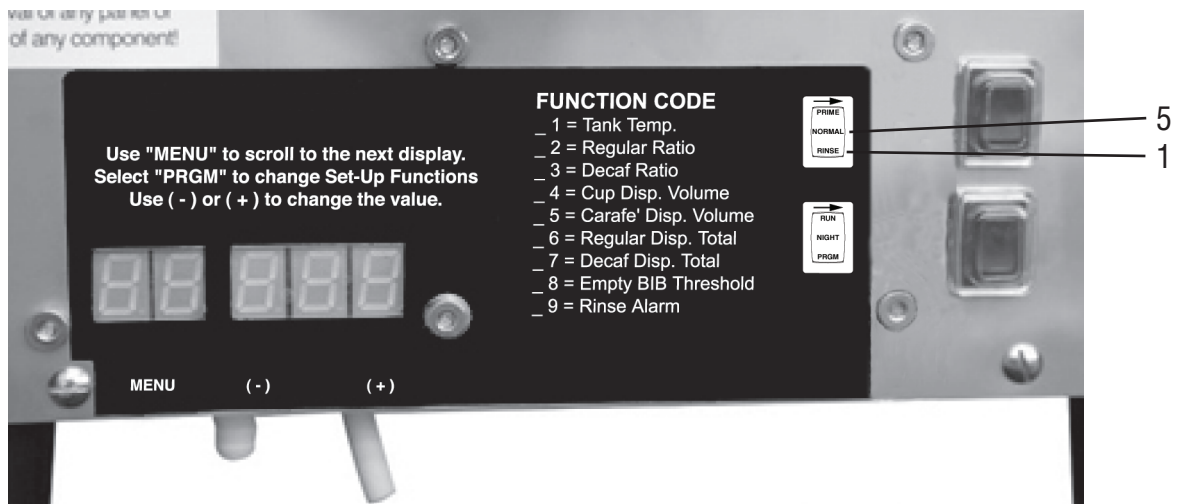

PROGRAMMING THE DISPENSER

Open the dispenser door to access the digital programming module with LED display. Two basic modes are available to the operator: Display Mode and Program Mode. To enter the Display Mode, Set the RUN/NIGHT/PROGRAM Switch to the RUN position. To enter the Program Mode, Set the RUN/NIGHT/PROGRAM Switch to the PROGRAM position.

Display Mode: Used to view the current set-up values. Use the MENU switch to scroll to the next display.

NOTE: The display blanks out after two minutes of inactivity. Press any button to activate the display.

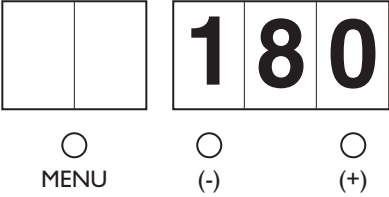
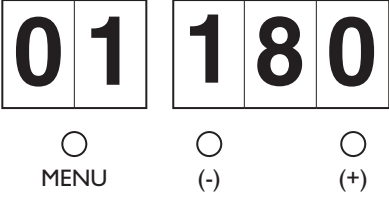
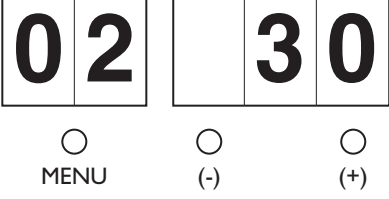
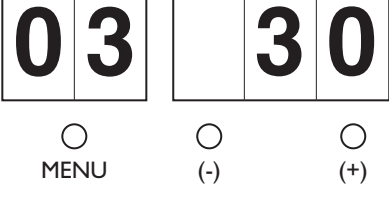
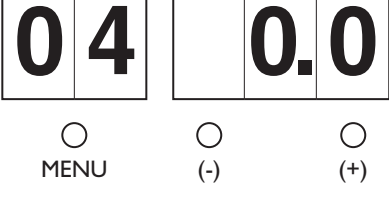
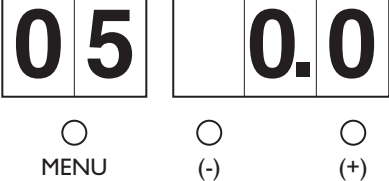
LCD DISPLAY	DISPLAY MODE	DESCRIPTION
	Home View	Displays Tank Temperature.
	Tank Temperature	Displays target Tank Temperature (F°)
	Regular Dispense Ratio	Displays Left Dispense Ratio (XXX:1)
	Decaf Dispense Ratio	Displays Right Dispense Ratio (XXX:1)
	Cup Dispense Volume	Displays Cup Dispense Volume (XX.X Oz.). Set to 0.0 for “Push and Hold” Dispense Mode.
	Carafe Dispense Volume	Displays Carafe Dispense Volume (XX.X Oz.)

PROGRAMMING THE DISPENSER (Cont.)

Display Mode (Continued)

LCD DISPLAY	DISPLAY MODE	DESCRIPTION
<div style="display: flex; justify-content: space-around;"> <div style="border: 1px solid black; padding: 5px; text-align: center;">06</div> <div style="border: 1px solid black; padding: 5px; text-align: center;">00.0</div> </div> <div style="display: flex; justify-content: space-around; margin-top: 5px;"> <div style="text-align: center;">○ MENU</div> <div style="text-align: center;">○ (-)</div> <div style="text-align: center;">○ (+)</div> </div>	Regular Dispense Total	Displays Total Regular Coffee Dispensed (XX.X Gal)
<div style="display: flex; justify-content: space-around;"> <div style="border: 1px solid black; padding: 5px; text-align: center;">07</div> <div style="border: 1px solid black; padding: 5px; text-align: center;">00.0</div> </div> <div style="display: flex; justify-content: space-around; margin-top: 5px;"> <div style="text-align: center;">○ MENU</div> <div style="text-align: center;">○ (-)</div> <div style="text-align: center;">○ (+)</div> </div>	Decaf Dispense Total	Displays Total Decaf Coffee Dispensed (XX.X Gal)
<div style="display: flex; justify-content: space-around;"> <div style="border: 1px solid black; padding: 5px; text-align: center;">08</div> <div style="border: 1px solid black; padding: 5px; text-align: center;">600</div> </div> <div style="display: flex; justify-content: space-around; margin-top: 5px;"> <div style="text-align: center;">○ MENU</div> <div style="text-align: center;">○ (-)</div> <div style="text-align: center;">○ (+)</div> </div>	Empty Product Threshold	Displays Empty Product Threshold (Default = 600)
<div style="display: flex; justify-content: space-around;"> <div style="border: 1px solid black; padding: 5px; text-align: center;">09</div> <div style="border: 1px solid black; padding: 5px; text-align: center;">OFF</div> </div> <div style="display: flex; justify-content: space-around; margin-top: 5px;"> <div style="text-align: center;">○ MENU</div> <div style="text-align: center;">○ (-)</div> <div style="text-align: center;">○ (+)</div> </div>	Rinse Alarm (Hrs)	Displays The Hours Between Required Rinses. (Default = 0 > OFF, Alarm Disabled)
<div style="display: flex; justify-content: space-around;"> <div style="border: 1px solid black; padding: 5px; text-align: center;">LC</div> <div style="border: 1px solid black; padding: 5px; text-align: center;">XX</div> </div> <div style="display: flex; justify-content: space-around; margin-top: 5px;"> <div style="text-align: center;">○ MENU</div> <div style="text-align: center;">○ (-)</div> <div style="text-align: center;">○ (+)</div> </div>		Displays Software Version # - Exits To Home View After 3 Seconds.

PROGRAMMING THE DISPENSER (Cont.)

Program Mode: Used to change or enter new set-up values.

To enter the **Program Mode**, Set the RUN/NIGHT/PROGRAM Switch to the PROGRAM position, the unit will display “__PPP” to indicate it is in the Program Mode. Use the MENU switch to scroll to the next display. Use the Increase (+) and Decrease (-) switch to adjust the values.

LCD DISPLAY	PROGRAM MODE	DESCRIPTION
<div style="display: flex; justify-content: space-around;"> <div style="border: 1px solid black; padding: 5px; text-align: center;">P 1</div> <div style="border: 1px solid black; padding: 5px; text-align: center;">1 8 0</div> </div> <div style="display: flex; justify-content: space-around; margin-top: 5px;"> <div style="text-align: center;">○ MENU</div> <div style="text-align: center;">○ (-)</div> <div style="text-align: center;">○ (+)</div> </div>	Tank Temperature	Default = 180°F Range = 120° - 200°F Ready Temp = Tank Temp minus 10°F
<div style="display: flex; justify-content: space-around;"> <div style="border: 1px solid black; padding: 5px; text-align: center;">P 2</div> <div style="border: 1px solid black; padding: 5px; text-align: center;">3 0</div> </div> <div style="display: flex; justify-content: space-around; margin-top: 5px;"> <div style="text-align: center;">○ MENU</div> <div style="text-align: center;">○ (-)</div> <div style="text-align: center;">○ (+)</div> </div>	Left (Regular) Dispense Ratio	Set Regular Coffee Ratio Default = 30:1 Range = 25 Max / 100 Min
<div style="display: flex; justify-content: space-around;"> <div style="border: 1px solid black; padding: 5px; text-align: center;">P 3</div> <div style="border: 1px solid black; padding: 5px; text-align: center;">3 0</div> </div> <div style="display: flex; justify-content: space-around; margin-top: 5px;"> <div style="text-align: center;">○ MENU</div> <div style="text-align: center;">○ (-)</div> <div style="text-align: center;">○ (+)</div> </div>	Right (Decaf) Dispense Ratio	Set Decaf Coffee Ratio Default = 30:1 Range = 25 Max / 100 Min
<div style="display: flex; justify-content: space-around;"> <div style="border: 1px solid black; padding: 5px; text-align: center;">P 4</div> <div style="border: 1px solid black; padding: 5px; text-align: center;">0.0</div> </div> <div style="display: flex; justify-content: space-around; margin-top: 5px;"> <div style="text-align: center;">○ MENU</div> <div style="text-align: center;">○ (-)</div> <div style="text-align: center;">○ (+)</div> </div>	Cup Dispense Volume	Set Cup Dispense Volume Default = 0.0, Push & Hold Range = 0.0 / 16.0 Oz.
<div style="display: flex; justify-content: space-around;"> <div style="border: 1px solid black; padding: 5px; text-align: center;">P 5</div> <div style="border: 1px solid black; padding: 5px; text-align: center;">0.0</div> </div> <div style="display: flex; justify-content: space-around; margin-top: 5px;"> <div style="text-align: center;">○ MENU</div> <div style="text-align: center;">○ (-)</div> <div style="text-align: center;">○ (+)</div> </div>	Carafe Dispense Volume	Set Carafe Dispense Volume Default = 0.0, Disabled Range = 0.0 / 64.0 Oz.
<div style="display: flex; justify-content: space-around;"> <div style="border: 1px solid black; padding: 5px; text-align: center;">P 6</div> <div style="border: 1px solid black; padding: 5px; text-align: center;">0.0</div> </div> <div style="display: flex; justify-content: space-around; margin-top: 5px;"> <div style="text-align: center;">○ MENU</div> <div style="text-align: center;">○ (-)</div> <div style="text-align: center;">○ (+)</div> </div>	Left (Regular) Dispense Total	Reset Total to Zero (00.0 Gal). Hold the Decrease (-) & Increase (+) switches for 10 sec.

PROGRAMMING THE DISPENSER (Cont.)

Program Mode (Continued)

LCD DISPLAY	PROGRAM MODE	DESCRIPTION
<div style="display: flex; justify-content: space-around;"> <div style="border: 1px solid black; padding: 5px; text-align: center;">P 7</div> <div style="border: 1px solid black; padding: 5px; text-align: center;">0.0</div> </div> <div style="display: flex; justify-content: space-around; margin-top: 5px;"> <div style="text-align: center;">○ MENU</div> <div style="text-align: center;">○ (-)</div> <div style="text-align: center;">○ (+)</div> </div>	Right (Decaf) Dispense Total	Reset Total to Zero (00.0 Gal). Hold the Decrease (-) & Increase (+) switches for 10 sec.
<div style="display: flex; justify-content: space-around;"> <div style="border: 1px solid black; padding: 5px; text-align: center;">P 8</div> <div style="border: 1px solid black; padding: 5px; text-align: center;">6 0 0</div> </div> <div style="display: flex; justify-content: space-around; margin-top: 5px;"> <div style="text-align: center;">○ MENU</div> <div style="text-align: center;">○ (-)</div> <div style="text-align: center;">○ (+)</div> </div>	Empty Product Threshold	Set Conductance Threshold Default = 600 Range = 100 Min / 900 Max To check Conductance of Hot Water, view the display while rinsing. Set value to 100 above reading.
<div style="display: flex; justify-content: space-around;"> <div style="border: 1px solid black; padding: 5px; text-align: center;">P 9</div> <div style="border: 1px solid black; padding: 5px; text-align: center;">O F F</div> </div> <div style="display: flex; justify-content: space-around; margin-top: 5px;"> <div style="text-align: center;">○ MENU</div> <div style="text-align: center;">○ (-)</div> <div style="text-align: center;">○ (+)</div> </div>	Rinse Alarm Timer	Default = OFF > Rinse Alarm Disabled Range = 2 - 24 hrs Reminder Only. No Lock Out. To clear alarm, set to RINSE Mode. Press Left switch, then Right switch for 15 seconds each.
<div style="display: flex; justify-content: space-around;"> <div style="border: 1px solid black; padding: 5px; text-align: center;">L C</div> <div style="border: 1px solid black; padding: 5px; text-align: center;">0 x x</div> </div> <div style="display: flex; justify-content: space-around; margin-top: 5px;"> <div style="text-align: center;">○ MENU</div> <div style="text-align: center;">○ (-)</div> <div style="text-align: center;">○ (+)</div> </div>		Displays Software Version # - Exits To Home View After 3 Seconds.

Program Lockout Function: The operator must hold down the stop and portion control button for 10 seconds while machine is in program mode. At 10 seconds, the machine's display changes from "PPP" to "PP LOC" indicating the locked position. At this point, the operator may view the setup functions, but not alter any of the parameters. In order to unlock the machine, repeat the aforementioned process. A MemoryLocked flag is set in eeprom so that the machine will retain this setting if power is lost.

LCD DISPLAY	PROGRAM FUNCTION	DESCRIPTION
<div style="display: flex; justify-content: space-around;"> <div style="border: 1px solid black; padding: 5px; text-align: center;">P P</div> <div style="border: 1px solid black; padding: 5px; text-align: center;">L O C</div> </div> <div style="display: flex; justify-content: space-around; margin-top: 5px;"> <div style="text-align: center;">○ MENU</div> <div style="text-align: center;">○ (-)</div> <div style="text-align: center;">○ (+)</div> </div>	Function Lockout Feature	Prevents the user from changing set-up functions

PRIMING THE CONCENTRATE LINES

1. Open the dispenser door.
2. Select **Prime** on the Function Selector Switch and **Run** on the Mode Selector Switch.
3. Close the dispenser door.
4. Place a container under the dispense tip.
5. Activate the appropriate dispenser until concentrate flows from the dispense nozzle. Priming may take 5 to 10 seconds.
6. Open the dispenser door, select **Normal** on the Function Selector Switch.

Note: Concentrate may continue to drip out of dispense tip. The user may wish to Rinse (refer to *Rinsing*) the dispenser to clean out the remaining concentrate.

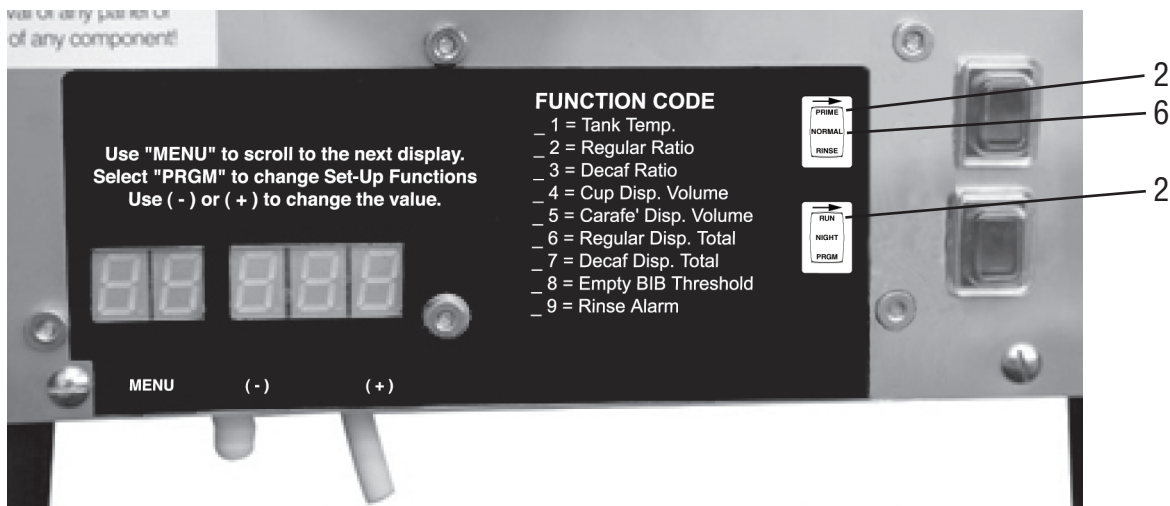

DRAINING THE HOT WATER TANK

CAUTION: The dispenser must be disconnected from the power source throughout these steps.

1. Disconnect the dispenser from the power source.
2. Shut off and disconnect the incoming water supply.
3. Remove the right side access panel.
4. Pull out drain tube to empty into a sink or a container with a minimum of 200 ounce capacity.
5. Make sure drain clamp is closed, then remove drain plug.
6. Direct tube into sink or container and open drain clamp. Continue draining tank until ALL of the water is out. Be careful when draining the water as it may be **very hot**.
7. Close drain clamp, insert drain plug, place drain tube back into machine, and replace the right side access panel.

Note: The dispenser must be refilled using the *Initial Fill & Heat* steps before reconnecting the power source.

OPERATING THE DISPENSER

Set the Function Selector Switch to “Normal” and the Mode Selector Switch to “Run.”

- 1A. Push and Hold Dispense Mode (Cup at a time). See *Programming Functions* to set this amount.
 - a. Place cup on the tray beneath the dispensing tip.
 - b. Push and hold the corresponding dispense switch until the container is full.
 - c. Remove cup or container.
- 1B. Portion Dispense Mode. (Cup dispense volume preset to a desired amount) Refer to *Programming Functions* to set this amount.
 - a. Place cup on the tray beneath the dispensing tip.
 - b. Momentarily press the desired dispense switch. The dispenser will automatically dispense the beverage at the preset amount. Allow the mix chamber to drain at the end of the cycle.
 - c. Remove cup.
2. Carafe Dispense Mode. Refer to *Programming Functions* to set this volume.
 - a. Place the appropriate size container beneath the dispensing tip.
 - b. Momentarily press the Portion Switch. The Portion LED will illuminate for 5 seconds after the Portion Switch is pressed.
 - c. Momentarily press the desired dispense switch. If the user waits longer than 5 seconds to push the switch, the dispenser will default back to the cup dispense mode. The carafe dispense mode can be disabled at any time during the dispense by either momentarily pushing the Dispense Switch again or pressing the Stop button.
 - d. Wait for the container to fill and the dispenser to quit dispensing, then remove the container.
3. Hot Water Dispense
 - a. Place a container under the dispense tip.
 - b. Push and hold the Hot Water switch until water reaches the desired level, then release.
 - c. Remove the container.

CLEANING & PREVENTATIVE MAINTENANCE

General Cleaning and Sanitizing Procedures

Note: The BUNN® LCA-2 LP dispenser incorporates a “user selectable” rinse reminder feature, which lights the Rinse LED on the front panel when it is time to rinse. See *Programming Functions* to activate this feature.

Daily: RINSING

1. Open the dispenser door and set the Function Switch to **Rinse** and the Mode Selector Switch to RUN.
2. Close the dispenser door and place a 1/2 gal (2 liter) container under the dispense nozzle area.
3. Activate both dispense switches until the water is clear or has no concentrate coloring in it, (10 to 20 sec.).
4. Open the dispenser door, set the Function Switch back to **Normal**.

Note: To clear the “Rinse” warning, activate both dispense switches (one at a time) until the flow stops automatically (approximately 20 sec. for each tip). The “Rinse” LED will turn off when the Rinse time has been satisfied.

Daily: PARTS WASHING

1. Remove and wash the drip tray and drip tray cover in a mild detergent solution. Rinse thoroughly.
2. Wipe the splash panel, dispense nozzles, door, and cabinet with a clean damp cloth.

Weekly: SANITIZING

1. Open dispenser door and select **Prime** on the Function Selector Switch and **Run** on the Mode Selector Switch.
2. Remove bag connector from the product box and disassemble or prop open the internal valve to allow free flow of product through the connector.
Note: Cutting the mating fittings from an empty bag makes an excellent “free flowing” connector for this purpose.
3. Place bag connector into a one gallon (3.8 liter) container of warm soapy tap water 140F (60C).
4. Place an empty container under dispense tip and activate corresponding Dispense Switch until clean soapy water is dispensed from the dispense tip.
5. Repeat steps 3 and 4 with warm tap water 140F (60C) to rinse the soapy water from the pump tubing. Continue activating Dispense Switch until water is clear, and no soapy water is being dispensed.
6. Prepare 2.5 gallons (9.5L) of sanitizing solution by dissolving 1 packet of Kay 5 sanitizer into 2.5 gallons (9.5L) of 120F (48.9C) water to ensure 100 ppm of available chlorine.
7. Repeat steps 3 and 4 with the sanitizing solution. Once sanitizing solution is visible, continue to dispense for 1 minute. Release handle and allow solution to sit for 5 minutes.
8. After soaking for 5 minutes, activate the dispense switch a second time, this time for 2 minutes. After 2 minutes, release the dispense switch.
9. Repeat step 5 with warm tap water to flush sanitizing solution out of the pump tubing.
10. Remove mating connector from the bag connector.
11. Reattach bag connector to product box.
12. Select **Normal** on Function Selector Switch and **Run** on Mode Selector Switch.
13. Actuate Dispense Switch until concentrate/water mixture appears. Continue to dispense at least 12 oz. (355 ml) of concentrate/water mixture and discard.
14. Repeat steps 1 through 13 for other dispense head.

PREVENTIVE MAINTENANCE

Bunn-O-Matic® Corporation recommends that preventive maintenance be performed at regular intervals. Maintenance should be performed by a qualified service technician. For Technical Service, contact Bunn-O-Matic® Corporation at 1-800-286-6070.

NOTE: Replacement parts or service caused by failure to perform required maintenance is not covered by warranty. Replace pump hoses every 6-Months or as needed.

REPLACING THE PUMP TUBING

The pumps and tubing used in the dispenser are designed to give maximum performance and long life. However, the tubes are a wear item and must be replaced periodically. How long the tubes last is dependent on usage and properties of the concentrate. Excessive wear will reduce the output of the pumps resulting in a weak mixed beverage. **Bunn-O-Matic recommends replacing the Pump Tubing a minimum of once every 6 months or sooner if warranted.**

Refer to the *Tube Replacement Instruction* inside the Cabinet door.

Note: To avoid concentrate spills, rinse the pump tubing with warm tap water prior to removing the tubes, (Refer to steps 1 - 4 of the *Weekly Sanitizing* instructions).

1. Loosen the thumbscrew (Fig 1) securing the tubing retainer plate to the pump body and set the retainer plate aside.
2. Depress the tension screw and remove it from the notch in the pump body, releasing the spring tension on the pump band (Fig 2).
3. Gently pull the pump tube from around the pump rotor (Fig 3).
4. Inspect the pump bands, rollers and housing for contamination or signs of wear. Clean or replace worn parts if necessary.
5. Apply lubricant (BUNN-O-MATIC part no. [M2531.0001](#)) to the middle section of the new pump tubing (Fig 4).
6. Carefully wrap the new tubing around the rotor, making sure that the elbow and clamps end up on the front side of the pump body (Fig 5).
7. Depress the tension screw and insert it in the notch in the pump body, reapplying spring tension on the pump band.
8. Install the free end of the tube over the inlet port of the mix chamber on that side of the cabinet (Fig. 5).
9. Replace the tubing retainer plate and tighten the thumbscrew.
9. Open the product container and insert the stainless steel drawtube into the container (Fig 6).
10. Repeat steps 1 through 9 for the other pump.

Note: Replacement Tube Kits can be purchased from BUNN-O-MATIC. Order part no. [37942.1000](#)

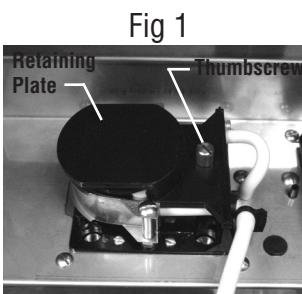

Remove Retaining Plate

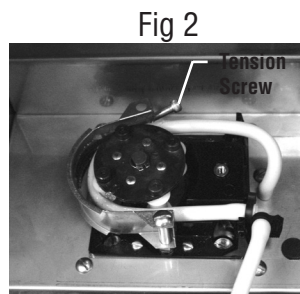

Release Spring Tension

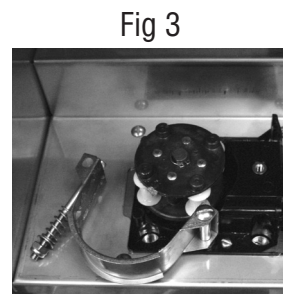

Remove Tubing

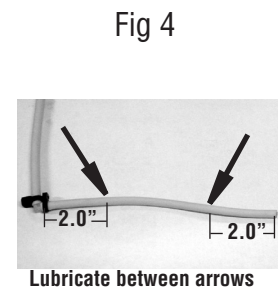

Lubricate New Tube

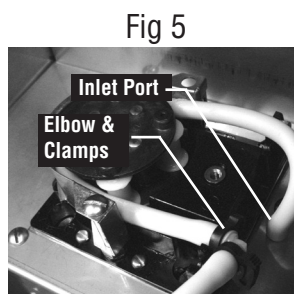



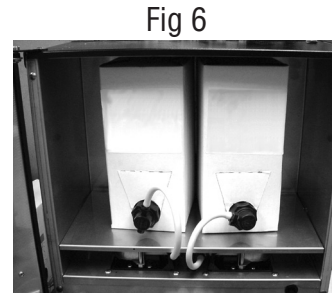

Install New Tubing

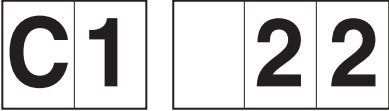

Completed Installation

CALIBRATING THE DISPENSER

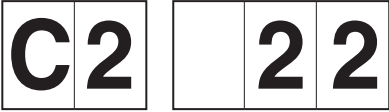
NOTE: The LCA-2 LP is calibrated at the factory and does not normally need to be re-calibrated. To enter the **Calibration Mode**, Set the RUN/NIGHT/PROGRAM Switch to the PROGRAM position and then hold the “MENU” switch down for 10 seconds.

LCD DISPLAY	CALIBRATION MODE	DESCRIPTION
 <p>○ MENU ○ (-) ○ (+)</p>	Left (Regular) Pump Cal.	Set PRIME-NORMAL-RINSE switch to PRIME position. Press and hold Regular Dispense Switch until pump stops (20 sec.) Refer to <i>Field Calibration of the Concentrate Pumps</i> .
 <p>○ MENU ○ (-) ○ (+)</p>	Left (Regular) Pump Cal.	Enter mL collected from the 20 sec. test above. Default = 22 Range = 18 - 26mL
 <p>○ MENU ○ (-) ○ (+)</p>	Right (Decaf) Pump Cal.	Set PRIME-NORMAL-RINSE switch to PRIME position. Press and hold Decaf Dispense Switch until pump stops (20 sec.) Refer to <i>Field Calibration of the Concentrate Pumps</i> .
 <p>○ MENU ○ (-) ○ (+)</p>	Right (Decaf) Pump Cal.	Enter mL collected from the 20 sec. test above. Default = 22 Range = 18 - 26mL
 <p>○ MENU ○ (-) ○ (+)</p>	Left (Regular) Water Rate	Set PRIME-NORMAL-RINSE switch to RINSE position. Press and hold Regular Dispense Switch until flow stops (20 sec.) Refer to <i>Field Calibration of the Concentrate Pumps</i> .
 <p>○ MENU ○ (-) ○ (+)</p>	Left (Regular) Water Rate	Enter Liters collected from the 20 sec. test above. Default = 1.10 Range = 0.95 - 1.12 Liters

CALIBRATING THE DISPENSER (Cont.)

LCD DISPLAY

C4 **r u n**

○ MENU ○ (-) ○ (+)

CALIBRATION MODE

Right (Decaf) Water Rate

DESCRIPTION

Set PRIME-NORMAL-RINSE switch to RINSE position. Press and hold Decaf Dispense Switch until flow stops (20 sec.) Refer to *Field Calibration of the Concentrate Pumps*.

C4 **1.10**

○ MENU ○ (-) ○ (+)

Right (Decaf) Water Rate

Enter Liters collected from the 20 sec. test above.
Default = 1.10
Range = 0.95 - 1.12 Liters

C6 **200**

○ MENU ○ (-) ○ (+)

Pump "OFF" Delay

Delays the Pump turn off after a dispense.
Default = 200
Range = 1 - 999 mSec.

C7 **Eng**

○ MENU ○ (-) ○ (+)

English or Metric Mode

Eng for English
S.I. for Metric

C8 **- - -**

○ MENU ○ (-) ○ (+)

Error Code History

Displays last known Error Code
Depress the Decrease (-) to view the last 3 Errors.
Hold the Decrease (-) & Increase (+) switches for 10 sec. to Erase.

C9 **- - -**

○ MENU ○ (-) ○ (+)

Reset Factory Defaults

Resets all set up values to the Factory Default setting.
Hold both Increase (+) and Decrease (-) switch for 10 seconds.

LC **x x**





○ MENU ○ (-) ○ (+)

Displays Software Version # -
Exits To Home View After 3 Seconds.

TROUBLESHOOTING GUIDE

Error Codes

When an error has occurred, all Door LED's will be flashing. Open the Door to access the LED Display and record the Error Code. Refer to the list of Error Codes below to identify the problem. A troubleshooting guide is provided to suggest probable causes and remedies for the most likely problems encountered. If the problem remains after exhausting the troubleshooting steps, contact the Bunn-O-Matic Technical Service Department.

LED DISPLAY	ERROR	DESCRIPTION/TROUBLESHOOTING
 ○ MENU ○ (-) ○ (+)	Left (Regular) Pump Failed	Left Motor or RPM Sensor Failure. Check motor and RPM sensor wires for shorts or open connections.
 ○ MENU ○ (-) ○ (+)	Right (Decaf) Pump Failed	Right Motor or RPM Sensor Failure. Check motor and RPM sensor wires for shorts or open connections.
 ○ MENU ○ (-) ○ (+)	Heating Time Too Long	Tank Heater ON Continuous For More Than 1 Hour. Check heater wires for open connections.
 ○ MENU ○ (-) ○ (+)	Fill Time Too Long	Fill Valve ON Continuous For More Than 15 Minutes. Water turned OFF. Refill Valve disconnected. Faulty Valve.

TROUBLESHOOTING GUIDE (Cont.)

Error Codes (Continued)

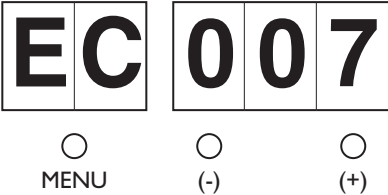
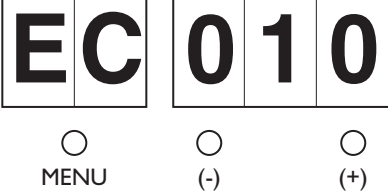
LED DISPLAY	ERROR	DESCRIPTION/TROUBLESHOOTING
	Tank Temp Sensor Failed	Sensor Reading Out Of Range (High or Low). Faulty Sensor wiring.
	Switch Board Failure	Unable To Communicate With The Switch Board In The Door. Faulty wiring between the Door and the Main Control Board.

Field Calibration of the Concentrate Pumps & Dispenser Flow Rates

The factory set default values for the Pump & Dispenser Flow Rates are very accurate and typically do not need to be field calibrated. However, if the mix ratio accuracy is ever in question, this procedure can be used to recalibrate the unit in the field.

Equipment Required:

50 to 100 ml graduated cylinder, with 1 ml graduations.

1500 to 2000 ml graduated container.

NOTE: You can calibrate either the Concentrate Pump or the Dispenser Flow Rate independently. Simply scroll through the menu screen to the desired section and perform only those steps. (refer to *Calibrating the Dispenser*)

Calibrating the Concentrate Pumps.

Regular Coffee - Concentrate Pump Calibration

1. Open the door of the dispenser and select PROGRAM on the Mode Selector Switch.
2. Depress and Hold the MENU switch for approximately 10 sec. The unit will display “**C1 run**” when it has entered the Calibration Mode.
3. Select PRIME on the Function Selector Switch.
4. Place a container under the left Dispense Tip and depress the Regular dispense switch until a steady stream of concentrate comes out the tip (5 to 10 seconds).
5. Stop priming and allow the tip to stop dripping. Discard the concentrate collected.
6. Place a 50 ml graduated cylinder under the Left Dispense Tip.
7. Press & Hold the Regular dispense switch. The dispenser will display a 20 second count down timer and then shut the pump OFF automatically. Release the dispense switch.
8. Keep the graduated cylinder under dispense tip until all the concentrate has dripped out.
9. Measure the volume of concentrate collected in the graduated cylinder.

The acceptable range for the volume of concentrate collected is 16 - 26 ml

10. If the amount collected is not within the acceptable range, empty the graduated cylinder and repeat STEPS 6 – 9.
11. If the amount collected is still not within range, replace the pump tubing with a new Tube Kit, (refer to the *Tube Replacement Instructions*).
12. When satisfied with the volume of concentrate collected, press the MENU switch. The current Calibration volume “**C1 XX**” will be displayed.
13. Use the (-) / (+) keys to adjust number displayed to the amount measured in STEP 9.

Decaffeinated Coffee - Concentrate Pump Calibration

Depress the MENU switch to display the Decaffeinated Concentrate Pump calibration menu “**C2 run**”.

Repeat STEPS 3 – 13 above for the right side “Decaf” pump.

Calibrating the Dispenser Flow Rates.

Regular Coffee - Dispenser Flow Rate Calibration

1. Select RINSE on the Function Selector Switch.
2. Press the MENU switch to display the Regular Coffee Flow Rate calibration menu “**C3 run**”
3. Place a container under Left Dispense Tip and depress the Regular dispense switch until a steady stream of water comes out the tip (5 to 10 seconds).

(Continued Next Page)

Field Calibration of the Concentrate Pumps & Dispenser Flow Rates (Continued)

4. Stop dispensing and allow the tip to stop dripping. Discard the water collected
5. Place a 1500 to 2000 ml graduated container under Left Dispense Tip.
6. Press & Hold the Regular dispense switch. The dispenser will display a 20 second count down timer and then stop dispensing automatically. Release the dispense switch.
7. Keep the graduated container under dispense tip until all the water stops dripping.
8. Measure the volume of water collected in the graduated container.

The acceptable range for the volume of water collected is .95 - 1.12 liters

9. If the amount of water collected is not within the acceptable range, empty the graduated container and repeat STEPS 5 – 8.
10. If the amount collected is still not within range, inspect the dispense valves, tubing and mix chamber for lime, kinks or other obstructions.
11. When satisfied with the volume of water collected, press the MENU switch. The current Water Calibration volume “**C3 XX**” will be displayed.
12. Use the (-) / (+) keys to adjust number displayed to the amount measured in STEP 8.

Decaffeinated Coffee - Dispenser Flow Rate Calibration

Depress the MENU switch to display the Decaffeinated Coffee Flow Rate calibration menu “**C4 run**”. Repeat STEPS 3 – 12 above for the right side “Decaf” pump.

Field Calibrating the Empty Product Warning

The dispenser will automatically turn on the Regular or Decaf “REFILL LED”, see *Operating Controls and Interface*, when the corresponding container is Empty. The Refill message is triggered when the conductance sensor reading drops below the minimum setting. The factory set minimum is 600 and should be correct for most locations. However, in some areas the hardness of the local water supply may effect this reading. If the Refill message doesn't come on when the container is empty or the message comes on too early and there is still concentrate left in the container, use the following procedure to find the correct Empty Product Threshold.

Calibrating The Empty Product Threshold

1. Open the dispenser door to access the digital programming module with LED display and set the Function Switch to the “Rinse” position. Leave the door open to view the LED display.
2. Place a large container under the dispenser tip, then activate and hold the Regular Coffee dispense switch.
3. Hold the dispense switch long enough to rinse all the concentrate out of the mix chamber and for the Conductance reading to stabilize and stop dropping.
4. Record the nominal Conductance value displayed. (NOTE: It is typical for this value to fluctuate (+/- 25) points about the nominal value.) This is the conductance reading of the water in your area.
5. Repeat steps 2, 3 & 4 for the Decaf Coffee dispenser.
6. Add 100 points to the larger of the Regular or Decaf conductance value. This is the new Empty Product threshold value for your dispenser.
7. Enter this new value into the Empty Product Alarm threshold position “**P8 XXX**”, see *Programming the Dispenser*.

SCHEMATIC WIRING DIAGRAM LCA-2 LP

