

BUNN®

TEA Servers



USE & CARE INFORMATION

CAUTION- CLEAN AND SANITIZE YOUR DISPENSER BEFORE USING. SEE NOTE 1 of DAILY CLEANING

BUNN-O-MATIC CORPORATION

POST OFFICE BOX 3227
SPRINGFIELD, ILLINOIS 62708-3227
PHONE: (217) 529-6601 FAX: (217) 529-6644

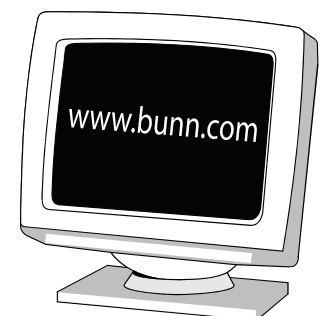

BUNN-O-MATIC COMMERCIAL PRODUCT WARRANTY

Bunn-O-Matic Corp. ("BUNN") warrants equipment manufactured by it as follows:

- 1) Airpots, thermal carafes, decanters, GPR servers, iced tea/coffee dispensers, MCR/MCP/MCA single cup brewers, thermal servers and ThermoFresh® servers (mechanical and digital) 1 year parts and 1 year labor.
- 2) All other equipment - 2 years parts and 1 year labor plus added warranties as specified below:
 - a) Electronic circuit and/or control boards - parts and labor for 3 years.
 - b) Compressors on refrigeration equipment - 5 years parts and 1 year labor.
 - c) Grinding burrs on coffee grinding equipment to grind coffee to meet original factory screen sieve analysis - parts and labor for 4 years or 40,000 pounds of coffee, whichever comes first.

These warranty periods run from the date of installation BUNN warrants that the equipment manufactured by it will be commercially free of defects in material and workmanship existing at the time of manufacture and appearing within the applicable warranty period. This warranty does not apply to any equipment, component or part that was not manufactured by BUNN or that, in BUNN's judgment, has been affected by misuse, neglect, alteration, improper installation or operation, improper maintenance or repair, non periodic cleaning and descaling, equipment failures related to poor water quality, damage or casualty. In addition, the warranty does not apply to replacement of items subject to normal use including but not limited to user replaceable parts such as seals and gaskets. This warranty is conditioned on the Buyer 1) giving BUNN prompt notice of any claim to be made under this warranty by telephone at (217) 529-6601 or by writing to Post Office Box 3227, Springfield, Illinois 62708-3227; 2) if requested by BUNN, shipping the defective equipment prepaid to an authorized BUNN service location; and 3) receiving prior authorization from BUNN that the defective equipment is under warranty.

THE FOREGOING WARRANTY IS EXCLUSIVE AND IS IN LIEU OF ANY OTHER WARRANTY, WRITTEN OR ORAL, EXPRESS OR IMPLIED, INCLUDING, BUT NOT LIMITED TO, ANY IMPLIED WARRANTY OF EITHER MERCHANTABILITY OR FITNESS FOR A PARTICULAR PURPOSE. The agents, dealers or employees of BUNN are not authorized to make modifications to this warranty or to make additional warranties that are binding on BUNN. Accordingly, statements by such individuals, whether oral or written, do not constitute warranties and should not be relied upon.

If BUNN determines in its sole discretion that the equipment does not conform to the warranty, BUNN, at its exclusive option while the equipment is under warranty, shall either 1) provide at no charge replacement parts and/or labor (during the applicable parts and labor warranty periods specified above) to repair the defective components, provided that this repair is done by a BUNN Authorized Service Representative; or 2) shall replace the equipment or refund the purchase price for the equipment.

THE BUYER'S REMEDY AGAINST BUNN FOR THE BREACH OF ANY OBLIGATION ARISING OUT OF THE SALE OF THIS EQUIPMENT, WHETHER DERIVED FROM WARRANTY OR OTHERWISE, SHALL BE LIMITED, AT BUNN'S SOLE OPTION AS SPECIFIED HEREIN, TO REPAIR, REPLACEMENT OR REFUND.

In no event shall BUNN be liable for any other damage or loss, including, but not limited to, lost profits, lost sales, loss of use of equipment, claims of Buyer's customers, cost of capital, cost of down time, cost of substitute equipment, facilities or services, or any other special, incidental or consequential damages.

392, A Partner You Can Count On, Air Infusion, AutoPOD, AXIOM, BrewLOGIC, BrewMETER, Brew Better Not Bitter, BrewWISE, BrewWIZARD, BUNN Espresso, BUNN Family Gourmet, BUNN Gourmet, BUNN Pour-O-Matic, BUNN, BUNN with the stylized red line, BUNNlink, Bunn-O-Matic, Bunn-O-Matic, BUNNserve, BUNNSERVE with the stylized wrench design, Cool Froth, DBC, Dr. Brew stylized Dr. design, Dual, Easy Pour, EasyClear, EasyGard, FlavorGard, Gourmet Ice, Gourmet Juice, High Intensity, iMIX, Infusion Series, Intellisteam, My Café, Phase Brew, PowerLogic, Quality Beverage Equipment Worldwide, Respect Earth, Respect Earth with the stylized leaf and coffee cherry design, Safety-Fresh, savemycoffee.com, Scale-Pro, Silver Series, Single, Smart Funnel, Smart Hopper, SmartWAVE, Soft Heat, SplashGard, The Mark of Quality in Beverage Equipment Worldwide, ThermoFresh, Titan, trifacta, TRIFECTA (stylized logo), Velocity Brew, Air Brew, Beverage Bar Creator, Beverage Profit Calculator, Brew better, not bitter., Build-A-Drink, BUNNSource, Coffee At Its Best, Cyclonic Heating System, Daypart, Digital Brewer Control, Element, Milk Texturing Fusion, Nothing Brews Like a BUNN, Picture Prompted Cleaning, Pouring Profits, Signature Series, Sure Tamp, Tea At Its Best, The Horizontal Red Line, Ultra are either trademarks or registered trademarks of Bunn-O-Matic Corporation. The commercial trifacta® brewer housing configuration is a trademark of Bunn-O-Matic Corporation.

USE & CARE INFORMATION

INTRODUCTION

These dispensers are designed to hold and serve either a three and a half, four or five gallon batch of iced tea or iced coffee, depending on the model. When proper precautions are followed, tea/coffee may be brewed directly into the dispenser and then transported to a remote serving location. The dispenser must be placed on a sturdy counter or shelf.

- * **CAUTION: YOU MUST BE CAREFUL WHEN LIFTING THESE DISPENSERS. WHEN THE DISPENSER IS HOLDING LIQUID.**
- * **CAUTION: LIFT THE DISPENSER USING THE HANDLES ONLY.**
- * **CAUTION: DO NOT LIFT THE DISPENSER FROM THE BOTTOM.**
CAUTION: DO NOT USE FAUCET AS HANDLE.
- * **NOTICE: DO NOT BREW INTO PLASTIC LINER BY ITSELF (If equipped) IT MUST BE IN IT'S STAINLESS STEEL HOUSING.**
- * **NOTICE: DO NOT USE BREW THROUGH LID WITH POUCH PACK FUNNELS WHEN BREWING INTO TD3T-N.**
- * **NOTICE: DO NOT OVER TIGHTEN FAUCET WING NUT. HAND TIGHTEN ONLY**
Failure to observe caution may result in personal injury.

TD0/N-3.5 dispenser weighs approximately 35 pounds when full.

TD0/N-4 dispenser weighs approximately 48-50 pounds when full.

TD0-5 weighs approximately 59 pounds when full.

TDS-3S & ICD-3S weigh approximately 40 pounds when full.

TDS-5S weighs approximately 55 pounds when full.

TD4/TD4T These dispensers are designed to hold and serve up to 4-gallons of iced tea or iced coffee.

TD4T-DR These dispensers are designed to hold and serve up to 2 gallons of cold beverage in each of two reservoirs at remote locations. Two separate reservoirs, each having its own faucet, means you can now serve two different kinds of beverage. Easy to see indicators on the front of the dispenser shows when a refill is needed to either reservoir.

DAILY CLEANING INSTRUCTIONS



STEP 1

Once a day, turn the faucet wing nut in a clockwise direction and remove the faucet from the dispenser. Unscrew the faucet bonnet from the faucet body and disassemble all faucet parts.

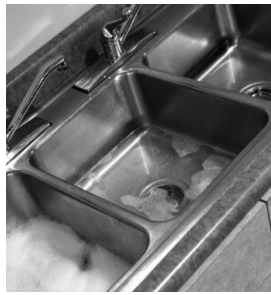

STEP 2

Transfer these parts to a three compartment sink for cleaning. Fill the first sink with a soap solution using a mild detergent, the second sink is used for clean rinse, and the third sink with a sanitizer solution (75°F warm chlorine solution of 50-100 ppm).



STEP 3

Use a brush to thoroughly scrub the faucet body.



STEP 4

Allow the parts to soak in a sanitizer solution for a minimum of ten minutes.



STEP 5

Remove the faucet parts from the sanitizer solution. Allow parts to air dry overnight. Reassemble faucet assembly prior to brewing into dispenser. Wash the entire outside surface of the dispenser with a clean damp cloth.

USE ONLY NONABRASIVE CLEANERS

REMOVABLE RESERVOIRS



STEP A

Clean reservoir in housing like other servers below.

OR

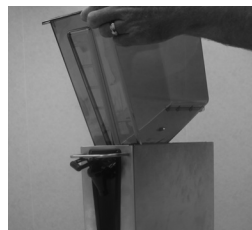

STEP A

Lift reservoir up, then tilt forward to clear faucet.

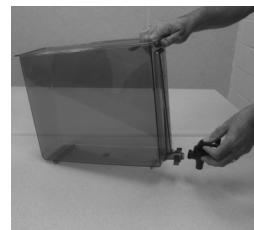

STEP B

Remove faucet following steps 1-5 above.

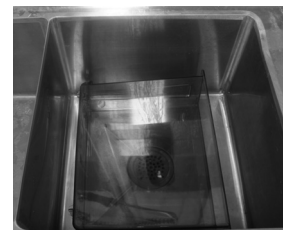

STEP C

Soak/clean reservoir in large sink following steps above.

CLEANING INSTRUCTIONS



STEP 1

Once a week, fill the dispenser with a chlorine solution (75°F warm chlorine solution of 50-100 ppm).
(EXAMPLE: TDO shown)



STEP 2

Draw a small amount (2 oz.) of presoak through the faucet making contact with the faucet components. Allow the dispenser to soak overnight.



STEP 3

The next morning, perform the daily cleaning procedures on the faucet and dispenser.

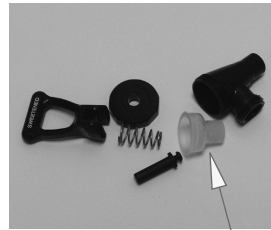

STEP 1







Once a month, replace the faucet seat cup. Discard the old seat cup.



STEP 2

The faucet assembly can be ordered for replacement.

DO NOT KEEP BREWED BEVERAGES OVERNIGHT

						
DESCRIPTION	PART NUMBER					
Decal, Fresh Brewed Tea	03043.0002	03043.0004	03043.0004	03043.0004	03043.0004	47501.0000
Decal, Iced Coffee	X	21412.0001	X	X	X	X
Decal, Bunn	00651.0000	00651.0000	00651.0000	00651.0000	00651.0000	X
Cleaning Card	49562.0000	49562.0000	49562.0000	49562.0000	49562.0000	49562.0000
Lid, Solid	03255.0000 4/4T 27155.1000 D.R.	33130.0000 SST 49203.0000 Plas	34093.0000	40851.0000	39624.0000	44310.0002
Lid, Brew Thru	03255.0002	X	34093.0001	X	X	44310.0000
Reservoir	03078.1002 TD4 26941.1000 D.R.	X	X	X	X	44309.0001
Feet	01175.0000	X	X	43379.1000	43379.1000	01175.0000
Drip Tray	X	X	X	X	39626.0000	X
Cover, Drip Tray	X	X	X	X	39627.0000	X
Handle	X	X	X	40854.0000	X	40854.0000

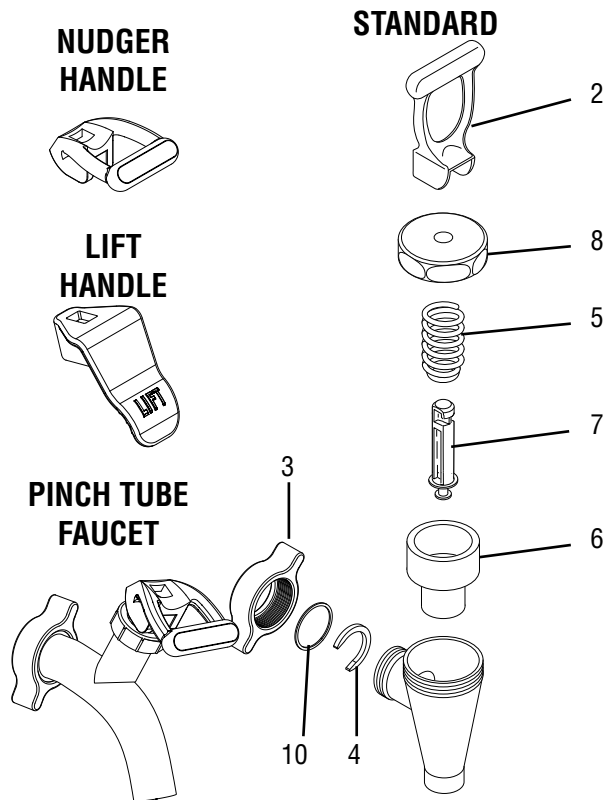

No repair kit available

COMMON REPLACEMENT PARTS

Refer to www.bunn.com for complete Illustrated Parts Catalog

1. [03260.0001](#) Faucet Assy (Bunn Black) (Includes 2, 5 - 8)
- [03260.0002](#) Faucet Assy (Swt/Unswt) (Includes 2, 5 - 8)
- [03260.0019](#) Faucet Assy (Nudger) (Includes 2, 5 - 8)
- [47326.1000](#) Pinch Tube Faucet Assy
- [03260.0021](#) Lift Handle Faucet Assy (Includes items 2, 5 - 8)
2. [29163.0001](#) Faucet Handle, Bunn Black
- [29163.0003](#) Faucet Handle, (Swt/Unswt)
- [32253.0001](#) Faucet Handle, Nudger
- [45946.0000](#) Faucet Handle, Lift
3. [03093.0002](#) Faucet Wing Nut
4. [01221.0000](#) C-Ring, Faucet Shank (Except Nudger Assy)
5. [00601.0000](#) Faucet Spring (Except pinch)
6. [00600.0000](#) Faucet Seat Cup (Except pinch)
7. [29164.0000](#) Faucet Stem (Except pinch)
8. [29165.0001](#) Faucet Bonnet, Black (Except pinch)
9. [29166.0001](#) Faucet Repair Kit (Bunn-O-Matic) (Incl 2, 5-7)
- [29166.0002](#) Faucet Repair Kit (Swt/Unswt) (Incl 2, 5-7)
- [41183.0000](#) Faucet Repair Kit (Swt/Unswt) (Includes 1,3, 4)
- [29166.0008](#) Faucet Repair Kit, Nudger
- [29166.0009](#) Faucet Repair Kit, Lift Handle
10. [45415.0000](#) Washer