



Innovative Foodservice Equipment Custom
Designed for Performance, Service and Value.

INSTALLATION AND OPERATING INSTRUCTIONS

Proofer Cabinet

Models:

PICA70-32-A

PICA70-32INS-A



**INTENDED FOR OTHER THAN HOUSEHOLD USE
RETAIN THIS MANUAL FOR FUTURE REFERENCE
UNIT MUST BE KEPT CLEAR OF COMBUSTIBLES AT ALL TIMES**

FOR YOUR SAFETY



Do not store or use gasoline or other flammable vapors and liquids in the vicinity of this or any other appliance.



WARNING



Improper installation, adjustment, alteration, service or maintenance can cause property damage, injury or death. Read the Installation, Operating and Maintenance Instructions thoroughly before installing or servicing this equipment.



This equipment has been engineered to provide you with year round dependable service when used according to the instructions in this manual and standard commercial kitchen practices.



Phone: +1 (214) 421-7366
Fax: +1 (214) 565-0976
Toll Free: +1 (800) 441-1601
Website: www.BevLes.com
E-mail: sales@BevLes.com

P/N 780086 5/08

BevLes
729 Third Avenue
Dallas, TX 75226









The **BevLes Company** takes pride in the design and quality of our products. When used as intended and with proper care and maintenance, you will experience years of reliable operation from this equipment. To ensure best results, it is important that you read and follow the instructions in this manual carefully. Installation and start-up should be performed by a qualified installer who thoroughly reads, understands and follows these instruction.

If you have questions concerning the installation, operation, maintenance or service of this product, write Technical Service Department BevLes Company, Inc., 729 Third Avenue, Dallas, TX 75226

SAFETY PRECAUTIONS













Before installing and operating this equipment be sure everyone involved in its operation is fully trained and aware of all precautions. Accidents and problems can result from a failure to follow fundamental rules and precautions.















The following words and symbols, found in this manual, alert you to hazards to the operator, service personnel or the equipment. The words are defined as follows:

- | | | |
|--|--|--|
|  | DANGER: This symbol warns of imminent hazard which may result in serious injury or death. |  |
|  | WARNING: This symbol refers to a potential hazard or unsafe practice, which could result in serious injury or death. |  |
|  | CAUTION: This symbol refers to a potential hazard or unsafe practice, which may result in minor or moderate injury or product or property damage. |  |
|  | NOTICE: This symbol refers to information that needs special attention or must be fully understood even though not dangerous. |  |

GENERAL INFORMATION

THIS MANUAL SHOULD BE RETAINED FOR FUTURE REFERENCE

- | | | |
|---|--|---|
|  | CAUTION: These models are designed, built, and sold for commercial use. If these models are positioned so the general public can use the equipment make sure that cautions, warnings, and operating instructions are clearly posted near each unit so that anyone using the equipment will use it correctly and not injure themselves or harm the equipment. |  |
|  | WARNING: Check the data plate on this unit before installation. Connect the unit only to the voltage and frequency listed on the data plate. Connect only to 1 phase as listed on the data plate. |  |
|  | WARNING: Electrical and grounding connections must comply with the applicable portions of the national electrical code and/or other local electrical codes. |  |
|  | WARNING: Disconnect device from electrical power supply and place a Tag Out-Lockout on the power plug, indicating that you are working on the circuit. |  |
|  | WARNING: Install per the spacing requirements listed in the installation section of this manual. We strongly recommend having a competent professional install the equipment. A licensed electrician should make the electrical connections and connect power to the unit. Local codes should always be used when connecting these units to electrical power. In the absence of local codes, use the latest version of the National Electrical Code. |  |
|  | WARNING: This device should be safely and adequately grounded in accordance with local codes, or in the absence of local codes, with the National Electrical Code, ANSI/NFPA 70, latest edition to protect the user from electrical shock. It requires a grounded system and a dedicated circuit, protected by a fuse or circuit breaker of proper size and rating. Canadian installation must comply with the Canadian Electrical Code, CSAC22.2, as applicable. |  |

	WARNING: Never clean any electrical unit by immersing it in water. Turn off before cleaning surface.	
	WARNING: An earthing cable must connect the appliance to all other units in the complete installation and from there to an independent earth connection.	
	NOTICE: The unit when installed, must be electrically grounded and comply with local codes, or in the absence of local codes, with the National Electrical Code ANSI/NFPA70 latest edition. Canadian installation must comply with CSA-STANDARD C.22.2 Number 0 M1982 General Requirements- Canadian Electrical Code Part II, 109-M1981- Commercial Cooking Appliances.	
	WARNING: SHOCK HAZARD - De-energize all power to equipment before cleaning the equipment.	
	NOTICE: This product is intended for commercial use only. Not for household use.	
	NOTICE: Local codes regarding installation vary greatly from one area to another. The National Fire Protection Association, Inc. states in its NFPA96 latest edition that local codes are "Authority Having Jurisdiction" when it comes to requirement for installation of equipment. Therefore, installation should comply with all local codes.	
	WARNING: SHOCK HAZARD - Do not open any panels that require the use of tools.	

IMMEDIATELY INSPECT FOR SHIPPING DAMAGE

All containers should be examined for damage before and during unloading. The freight carrier has assumed responsibility for its safe transit and delivery. If equipment is received damaged, either apparent or concealed, a claim must be made with the delivering carrier.

A) Apparent damage or loss must be noted on the freight bill at the time of delivery. It must then be signed by the carrier representative (Driver). If this is not done, the carrier may refuse the claim. The carrier can supply the necessary forms.

B) If concealed damage or loss is not apparent until after equipment is uncrated, a request for inspection must be made to the carrier within 15 days. The carrier should arrange an inspection. Be certain to hold all contents and packaging material.

Installation and start-up should be performed by a qualified installer who thoroughly reads, understands and follows these instructions.

TABLE OF CONTENTS

Safety Precautions..... 2-3

General Information 3

Unpacking Instructions 4

Setting Up..... 4

Operation..... 4-5

Troubleshooting Tips 6-7

Additional Information 7

Parts List & Parts Diagram..... 8-9

Total Unit Dimensions..... 10

Humidity-Heating Module Wiring Diagram 11

Humidity-Heating Module Parts List & Parts Diagrams..... 12-15

Humidity-Heating Module Dimensions..... 16

Warranty 20

UNPACKING INSTRUCTIONS:

Note: All Bevi's cabinets are tested, inspected and expertly packed to insure arrival in a ready-to-use condition. If any damage or loss is discovered when unpacking, ask the carrier's agent (in writing) to inspect the product. *This must be done within 15 days of delivery.* You can then file a formal claim with the carrier.

This product has been shipped securely packed on a wooden pallet, covered with a protective bag and corrugated shipping container and sealed with durable banding material. Carefully read the following unpacking instructions and properly dispose of all packaging materials.

To open:

1. Carefully cut and remove banding material.
2. Carefully lift the corrugated container off the product.
3. Remove the protective bag, tear, or tie several knots and appropriately place in a trash container.
4. Release all wheel brakes.
5. Carefully roll cabinet off pallet.
6. Check model number on the serial number label (located on the bottom right front corner of the unit) against the packing slip.
7. Remove the carton containing the universal pan supports from the top of the pallet.
8. Open door(s) and remove packing materials (tape, cardboard, etc.).

SETTING-UP

1. Open the carton containing the universal pan supports and install all supports in cabinet. Install the pan supports from the bottom up leaving one extra (unused) slot at the top of each of the four uprights.
2. Make certain that the Lexan® water pan cover is properly installed over the cast water pan and over the louvers in front of the pan.
3. Insert a standard 18" x 26" sheet pan (not provided with proofer) in the slides under the base of the cabinet. This will serve as a drip pan when cabinet is in use.
4. Place the cabinet in the location where it will be operated. When in position secure the brakes on the front two wheels. These brakes should always be locked when the cabinet is in use.

OPERATION

1. Make certain that your unit is properly plugged into the correct power source as specified on the serial number label.
2. Verify that wheel brakes are in locked position (front two casters).
3. Inspect humidity pan for proper water level (1/2 to 3/4 full).
Refer to picture of control panel below for the following steps.
4. Set the temperature control to the desired cabinet temperature. 90°F to 100°F is recommended as a starting position. Increase or decrease the cabinet temperature as needed to best suit your application.
5. Set the humidity control to the #3 or #4 position. This can be increased if necessary to suit your specific application.
6. Make certain that a standard 18" x 26" sheet pan (not provided with proofer) has been inserted as a drip pan in the slides on the bottom "outside" of the cabinet.
7. Verify that the door(s) is closed and latched.
8. Push the power switch to the "ON" Position. Always use this switch to turn the unit "ON" or "OFF".
9. Allow approximately 30-45 minutes for the cabinet to achieve the necessary temperature and humidity that you desire.
10. The cabinet is now ready for product placement and the start of the proofing process.

Note: Different product, or even different batches of the same product may require different cabinet temperatures and humidity settings. This may result in longer, or possibly even shorter proofing times.

OPERATING TIPS

Always inspect wheel brakes before attempting to move the cabinet. Make certain that brakes are in the locked position before placing cabinet into operation.

During "cold" start-up you may want to set the Humidity Control to the HI setting for 10 to 15 minutes to accelerate the humidity process. Remember to re-set the Humidity Control back to the desired setting before beginning the proofing process. Once the cabinet has been loaded with product and the proofing process has started, the proofer door(s) should not be opened until proofing has been completed.

The 18" x 26" sheet pan (not provided with proofer) that serves as a drip pan under the cabinet base should be checked, and if necessary, emptied at the end of each day.

The cabinet should be cleaned whenever necessary. It should be thoroughly cleaned at least once a week.

Note: It is recommended that humidity be kept at the minimum level that is practical for your operation. Excessive humidity with condensation on the walls and/or base of the cabinet is not considered desirable.

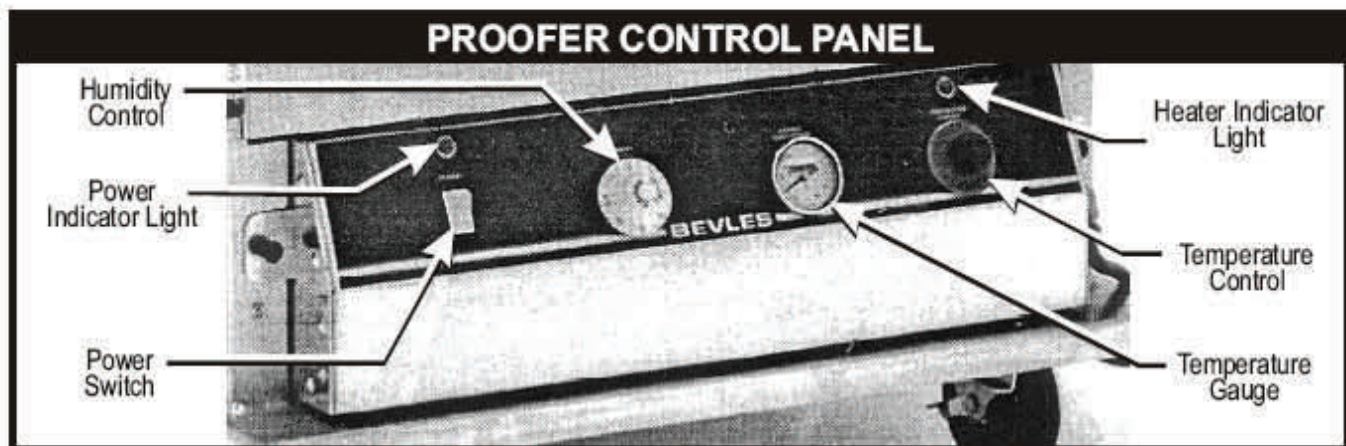

SAFETY AND HEALTH

BevLes Proofing Cabinets meet all cUL and NSF requirements. Always operate this proofer in accordance with the operating instructions found in this manual. Never remove the humidity-heating module without first disconnecting (unplugging) the unit from its power source. The cabinet is designed and built for easy cleaning. It should be cleaned frequently as described in the maintenance section.

MAINTENANCE

Cleaning: This cabinet was designed and built for maximum sanitation. It is not self cleaning, so it should be cleaned frequently with soap and water.

1. NEVER USE STEEL WOOL OR CAUSTIC CLEANING COMPOUNDS.
2. Make sure that the unit is turned OFF and **unplugged** from the electrical service.
3. Remove the Lexan® water pan cover and side covers from the humidity-heating module.
4. Remove the pan supports and vertical uprights.
5. Remove the vent from the rear wall.
6. Clean inside of cabinet with soap and water. Clean clear Lexan® water pan cover and Lexan® door(s) with soft sponge, soap and water.
NEVER USE HARSH CLEANING SUBSTANCES OR ABRASIVES TO CLEAN LEXAN® SURFACES, OR THE CAST ALUMINUM WATER PAN.
7. Remove and clean the 18" x 26" drip pan (not provided with proofer) from under the cabinet base.

If necessary, the humidity-heating module can be removed by loosening the two (2) black knurled knobs (one located at each side on the module on the exterior of the cabinet). The module can be pulled out of the cabinet for additional cleaning. We suggest that you clean the water pan at least once a month with a solution of white vinegar and hot water. Allow white vinegar to remain in water pan overnight. Then use a soft cloth to wipe away any mineral buildup.

Important: When placing the humidity heating module back into the cabinet make certain that the module is pushed tightly against the cabinet and secured with the two (2) black knurled knobs. Check to see that the one inch air flow opening at the rear of the humidity-heating module is behind the back vent that hangs on the rear wall of the cabinet. This is necessary to maintain uniform temperature and humidity distribution throughout the cabinet.

IF REPLACEMENT PARTS ARE EVER REQUIRED, ONLY USE PARTS THAT HAVE BEEN APPROVED BY BEVLES COMPANY, INC.

ASSISTANCE / SERVICE

Should you ever require assistance or service contact the BevLes manufacturing facilities at (800) 441-1601 or (214) 421-7366. When you phone please have the model number and serial number of the proofer. This will assist our service technicians in providing you immediate assistance. You may want to briefly review the Troubleshooting Tips before you contact our factory.

TROUBLESHOOTING TIPS

No Power

If your proofer fails to start when the power is applied via power switch:

1. Check to see if the unit is properly plugged into correct power source as specified on the serial number label.
2. Check to see that your power source (wall receptacle) has power - inspect circuit breaker.
3. Disconnect power cord and visually inspect for any damage.
4. Contact the BevLes Technical Service Department for assistance.

Excessive Humidity

If your proofer is producing excessive humidity:

1. Check the setting on the humidity control (white knob) to see if it is set at a normal operating level.
2. Check the base of the cabinet to see if the excess humidity is draining through the drain hole in the center of the base.
3. Contact the BevLes Technical Service Department for assistance.

No Humidity

If your proofer is producing no humidity, or considerably less than normally achieved:

1. Inspect water level in the water pan.
2. Check the setting on the humidity control (white knob) to see if it is set at a normal operating level.
3. Check to see if the cabinet door(s) is closed.
4. Make certain that the humidity-heating module's one inch air flow opening (at rear of module) is behind the cabinet back vent that hangs on the rear wall of the cabinet.
5. Make certain that the Lexan® water pan cover is correctly positioned over the entire water pan and the louvers located in front of the water pan.
6. Verify that the fan blower is operating.
7. Contact the BevLes Technical Service Department for assistance.

Excessive Heat

If your proofer temperature is higher than normal:

1. Check the setting on the temperature control (60°-120° knob) to see if it is set at a normal operating level.

2. Check the ambient room temperature to see if it is greater than your desired proofing temperature.
3. Contact the BevLes Technical Service Department for assistance.

No Heat

If your proofer is producing no heat, or considerably less than you normally achieve:

1. Check the setting on the thermostat (60°-120° knob) to see if it is set at a normal operating level.
2. Check to see if the cabinet door(s) is completely closed.
3. Make certain that the humidity-heating module's one inch air-flow opening (at rear of module) is behind the cabinet back vent that hangs on the rear wall of the cabinet.
4. Verify that the fan blower is operating.
5. Contact the BevLes Technical Service Department for assistance.

You may contact the BevLes Technical Service Department at (800) 441-1601 or (214) 421-7366. When you phone please have the model number and serial number of the proofer. This will assist our service technicians in providing you immediate assistance.

ADDITIONAL INFORMATION

Part Replacement Instructions

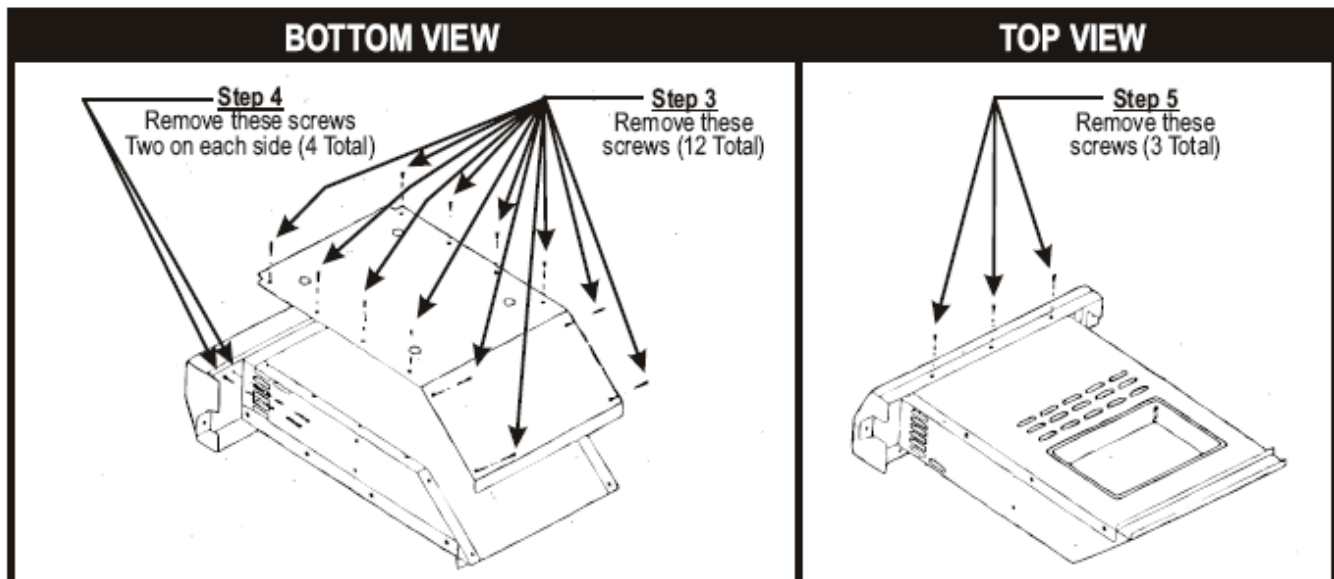

TO REPLACE THE THERMOSTAT:

1. Remove the two (black) knurled knobs (one located at each end of the control panel).
2. Pull the module out from the cabinet.

Refer to drawings above for steps 3, 4 and 5.

3. Remove the screws from the bottom of the module. (6 screws on each side, total of 12).
4. Remove screws from the back side of the control panel. (2 screws per side, total of 4).
5. Remove screws from the top edge of the control panel. (3 screws total).
6. Using a 5/64" Allen Wrench, remove the thermostat knob.
7. Remove (disconnect) the thermostat bulb from inside the module (against the side wall).
8. Unscrew and remove the thermostat.

After installing new thermostat, reverse the above steps. Make certain that the one inch air-flow opening at the back of the module is up behind the cabinet's back vent hanging on the rear wall.

Refer to wiring diagram on next page for additional information.

PARTS LIST

60	8509300	WASHER, FLAT, SAE, 5/16	16
59	8507900	WASHER, LOCK, INT, 1/4, Z	10
58	8506200	WASHER, LOCK, INT, #10, Z	14
57	8436200	NUT, HEX 5/16-18 S/S	16
56	8425200	NUT, HEX, 1/4-20 SS	4
55	8205500	SCREW, 1/4-20 X 1/2 TR HD	14
54	8203100	M/S FT HD PH 1/4-20 X 1/2 ZN	4
53	8196700	SCREW, SM, #10 X 3/4, TYPE AB	8
52	8175900	SCREW, 10-32 X 1/2 TR HD,SS	6
51	792014	SKID, PICA STYLE	1
50	791070	CARTON, HSC	1
49	790092	CARTON, HANGER & SLIDE	1
48	790008	BAG, POLY, 1.5 MIL, 62 x 84	1
47	784560	WIPER BLADE, 24.625 LG	1
45	783044	SPRING, LATCH	1
44	783040	COLLAR, Ø.375 x 1/4	2
43	783016	KNOB, THD STUD, 1/4-20 x .5	4
42	783012	BUTTON, UPRIGHT	8
41	780086	MANUAL, BEVELES PROOFERS	1
40	780040	CASTER 5" HARD SWIVEL	2
39	780036	CASTER 5" HARD SWIVEL W/BRAKE	2
38	770720	WASHER, FLAT, AN960CI56	1
37	770152	RIVET, SOFT, 1/4 x 1-3/4 BZR HEAD	2
36	770084	RIVET, SOFT, 5/16, 566PC/LB	40
35	770064	BOLT, CARRIAGE 5/16-18x.75 Z	16
34	770037	WASHER, LOCK, INT, 5/16	16
33	770000	RIVET, SOFT, 1/2 SHINY, 390/LB	22
32	760028	DOOR, LEXAN	1
31	750972	LATCH, STRIKE, PROOFER	1
30	750864	BRACKET, CORNER, DOOR	4
29	750724	PIN, HINGE	2
28	750720	PIN, LATCH	1
27	750437	BRACKET, HEADER BAR, LEFT	1
26	750436	BRACKET, HEADER BAR, RIGHT	1
25	750420	SLIDE GUIDE	34
24	750396	SPACER, BACK VENT	2
23	750392	LATCH	1
22	750384	FRAME, DOOR, TOP & BOTTOM	2
21	750380	FRAME DOOR LATCH SIDE	1
20	750379	FRAME, DOOR, HINGE SIDE	1
19	750132	HINGE, BUTT	2
18	743284	THREE-INCH CENTER UPRIGHT	4
17	741182	COVER, VALLEY	2
16	740368	RETAINER, WIPER, BOTTOM	1
15	740360	SIDE, OUTER, RIGHT	1
14	740359	SKIN, OUTER	1
13	740356	BACK, OUTER	1
12	740338	RUNNER, DRIP PAN RIGHT	1
11	740336	RUNNER, DRIP PAN LEFT	1
10	740332	HINGE, DOOR	4
9	740328	BASE STD PROOFER	1
8	740324	TOP, OUTER	1
7	740322	BACK VENT	1
6	740281	CLIP, BASE	2
5	720453	MODULE, BOTTOM	1
4	701015	POWER CORD 12/3	800 FT.
3	700428	CHANNEL, GASKET	16
2	1603500	CONNECTOR, CABLE 3/8 RACO 7316	2
1	1037200	TAPE, CLOSED CELL	12 FT
ITEM#	PART#	DESCRIPTION	QTY.

PARTS DIAGRAM

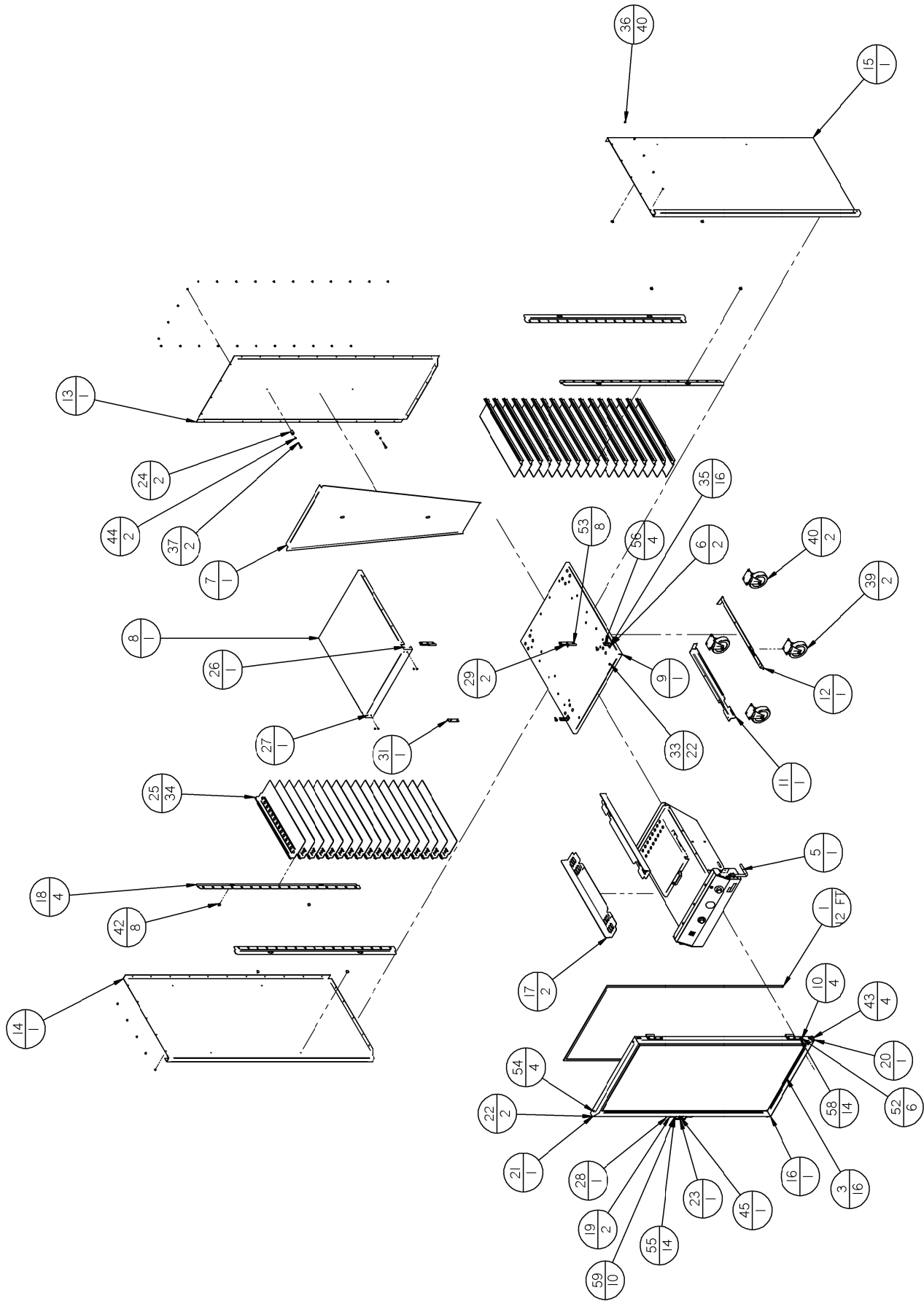

UNIT DIMENSIONS

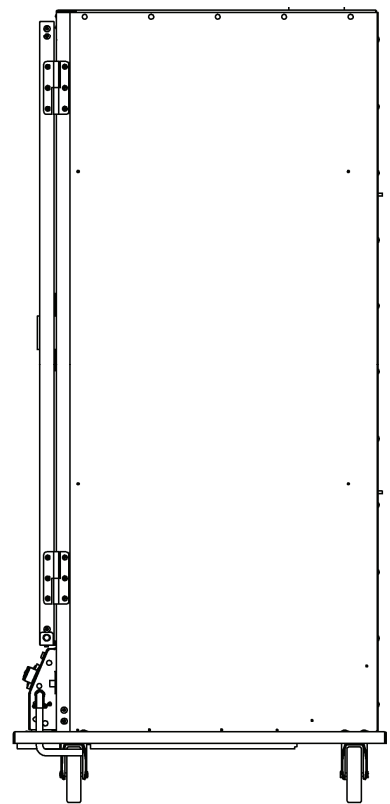
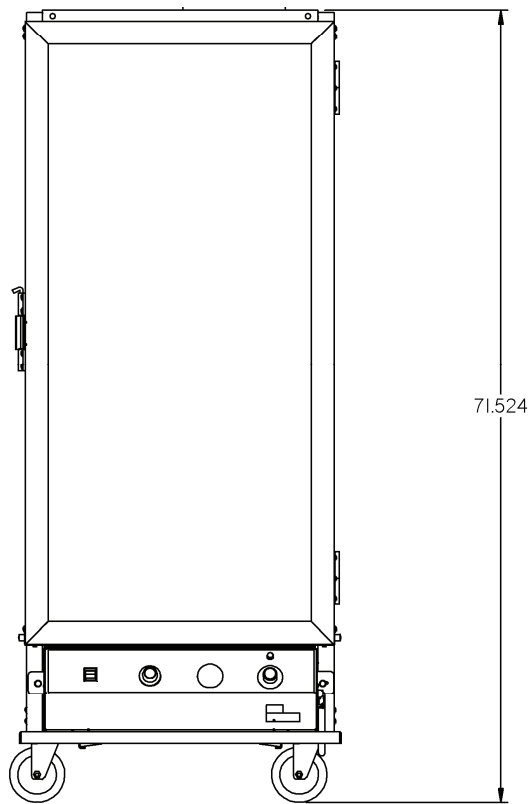
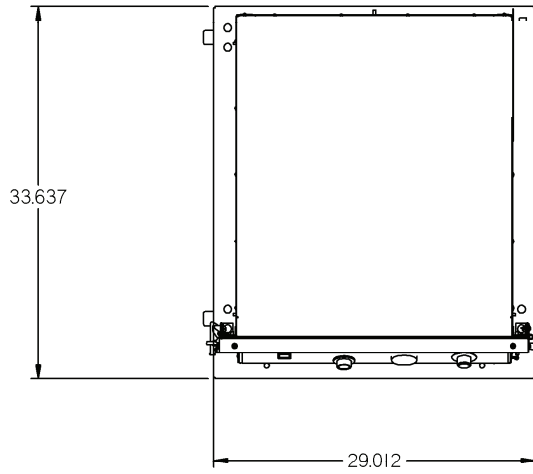

HUMIDITY-HEATING MODULE PARTS LIST

35	8980400	CLAMP 1/4" NYLON	2	71*	1509600	Pilot light GreenPowerl	1
34	760018	STRIP, SEALING, 1/8x1/2x24.375	1	70	784744	LABEL, DO NOT OPERATE	1
33	781036	DECAL, FRONT PANEL	1	69	740223	BRACKET, SENSOR	1
32	784538	INSERT, PLASTIC, SNAP-ON	4	68*	1102100	TERMINAL, HIGH TEMP	9
31	784536	CAP, PLASTIC SNAP-ON	4	67	8861000	LABEL, SERIAL NUMBER	1
30	8967200	BUSHING, SNAP .5 HOLE NYLON	3	66	8502500	#8 FLAT WASHER, S/S	2
29	8967000	BUSHING, SNAP HEYCO .5" I.D.	2	65	8408300	#8-32 HEX NUT, KEPS, NI	2
28	782092	KNOB, INFINITE SWITCH	1	64	81423-00	8-32 X .750 LG. SCREW	2
27	782120	KNOB, THERMOSTAT	1	63	11072-00	BLOCK TERINAL, 6 STATION 600V	1
26	783032	OBSOLETE USE 1101500	1	62	744294	COVER, DRIP, WATER	1
25	782076	POWER CORD 15A PICA 14-3	1	61	8162500	M/S #10-32 TRUSS HD	2
24	45653000	LIGHT, INDICATOR 250V, Ø 1/2" AMBER	1	60*	8353100	RIVNUT, 10-32 THIN HEAD	20
23	782088	SWITCH, INFINITE	1	59	760224	PAD, PROTECTIVE	2
22	782226	SWITCH, POWER, DPST	1	58	8353400	RIVET, POP 3/16 FLUSHBREAK	11
21	782133	THERMOMETER, 6" STEM	1	57	770084	RIVET, SOFT, 5/16, 566PC/LB	10
20	782208	THERMOSTAT	1	56	8402900	NUT, HEX, 6-32 SS	2
19	782028	THERMOSTAT, 60° - 120°	1	55	8158800	MS RD HD PH 10-24 X 1/2 SS	2
18	782020	ELEMENT, COIL, 1000W, 120V	1	54	8417600	NUT HEX 10-32 S/S	3
17	782204	BLOWER, MOTOR, 120V, PRF	1	53	8422400	#10-24 HX NUT GRN	2
16	784124	HANDLE, DRAWER PULL	1	52	8505300	FLAT WASHER, SAE #10	5
15	720079	ASSEMBLY, WATER PAN SET	1	51	8500900	WASHER, FLAT, #6, SS	2
14	760040	COVER, LEXAN, WATER PAN	1	50	8196700	SCREW, SM, #10 X 3/4, TYPE AB	12
13	740072	COIL AIR HEATER DEFLECTOR	1	49	8175900	SCREW, 10-32 X 1/2 TR HD	22
12	744869	MOUNT, MOTOR	1	48	8175200	M/S TR HD PH 10-32X1/2 ZN	9
11	720006	WELDMNT, DEFLECTOR, AIR DUCT	1	47*	1100000	BUTT SPLICE, INSUL	5
10	740464	SPLASH GUARD, MOTOR	1	46	8159000	SCREW, TR HD, 10-24x1/2, Z	2
9	740436	TOP OUTER SKIN UNIT	1	45	8506200	WASHER, LOCK, INT, #10, Z	15
8	744873	COVER, WIRE	1	44	8105800	SCREW, PH, 6-32x3/8, S/S	2
7	740448	SKIN, BOTTOM UNIT	1	43	782280	NUT, THERMOSTAT	1
6	740440	SIDE, OUTER RIGHT	1	42*	784064	WIRE SET PICA, #4001-A	2
5	740424	PANEL, FRONT	1	41*	784493	TERMINAL, RING, #10	1
4	740431	PANEL, FRONT, SIDE, RIGHT	1	40*	784052	WIRE NUT, ORANGE	1
3	740432	PANEL, FRONT, SIDE, LEFT	1	39*	1123000	TERMINAL, HT #10	1
2	740428	PANEL, BACK	1	38*	1501700	TIE, CABLE, 4"	10
1	740439	SIDE, OUTER LEFT	1	37*	791136	TIE, CABLE, 5 3/5 NYLON	3
ITEM	PART NUMBER	DESCRIPTION	REQ'D	ITEM	PART NUMBER	DESCRIPTION	REQ'D

HUMIDITY-HEATING MODULE PARTS DIAGRAM

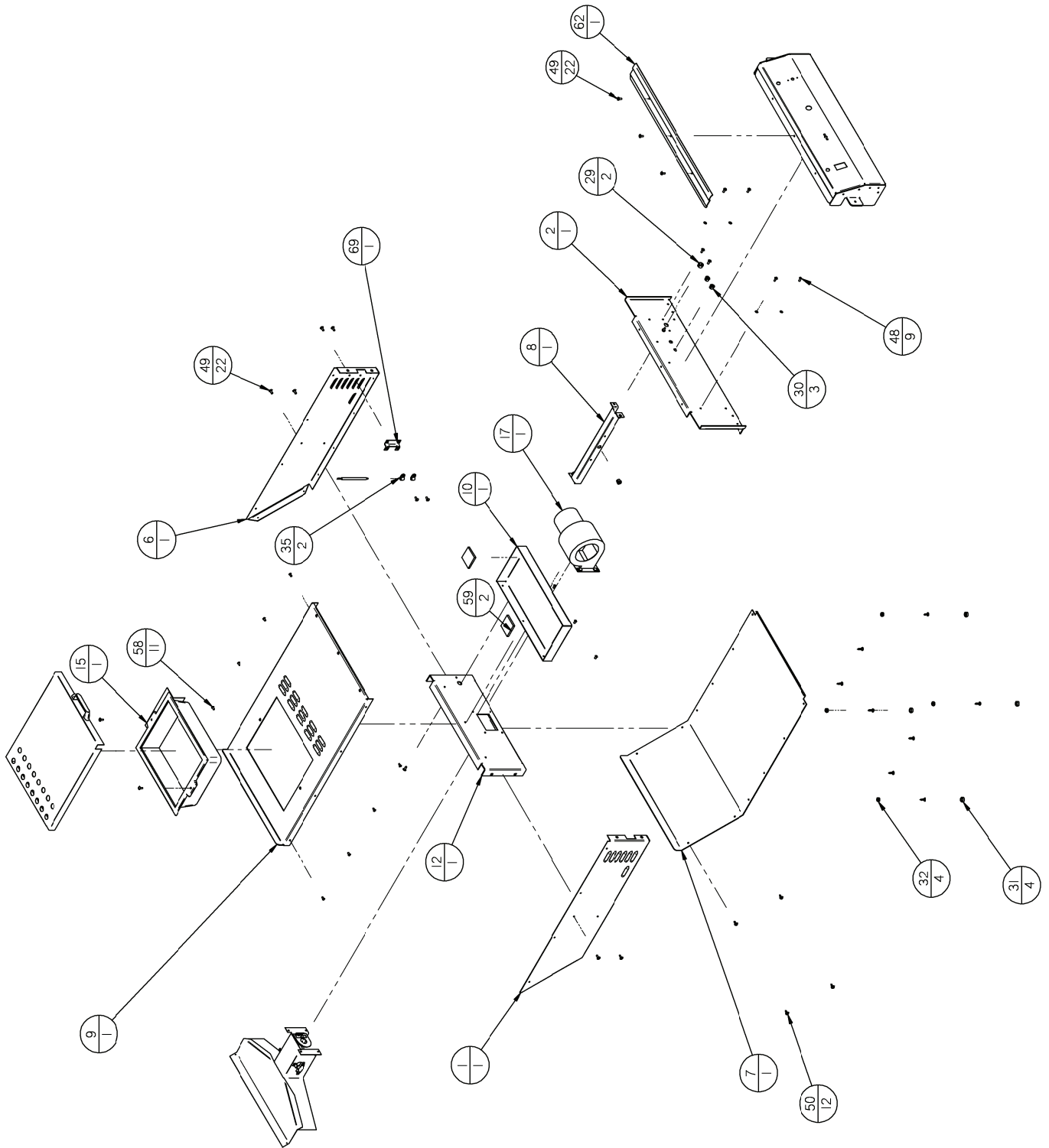

HUMIDITY-HEATING MODULE PARTS DIAGRAM (cont.)

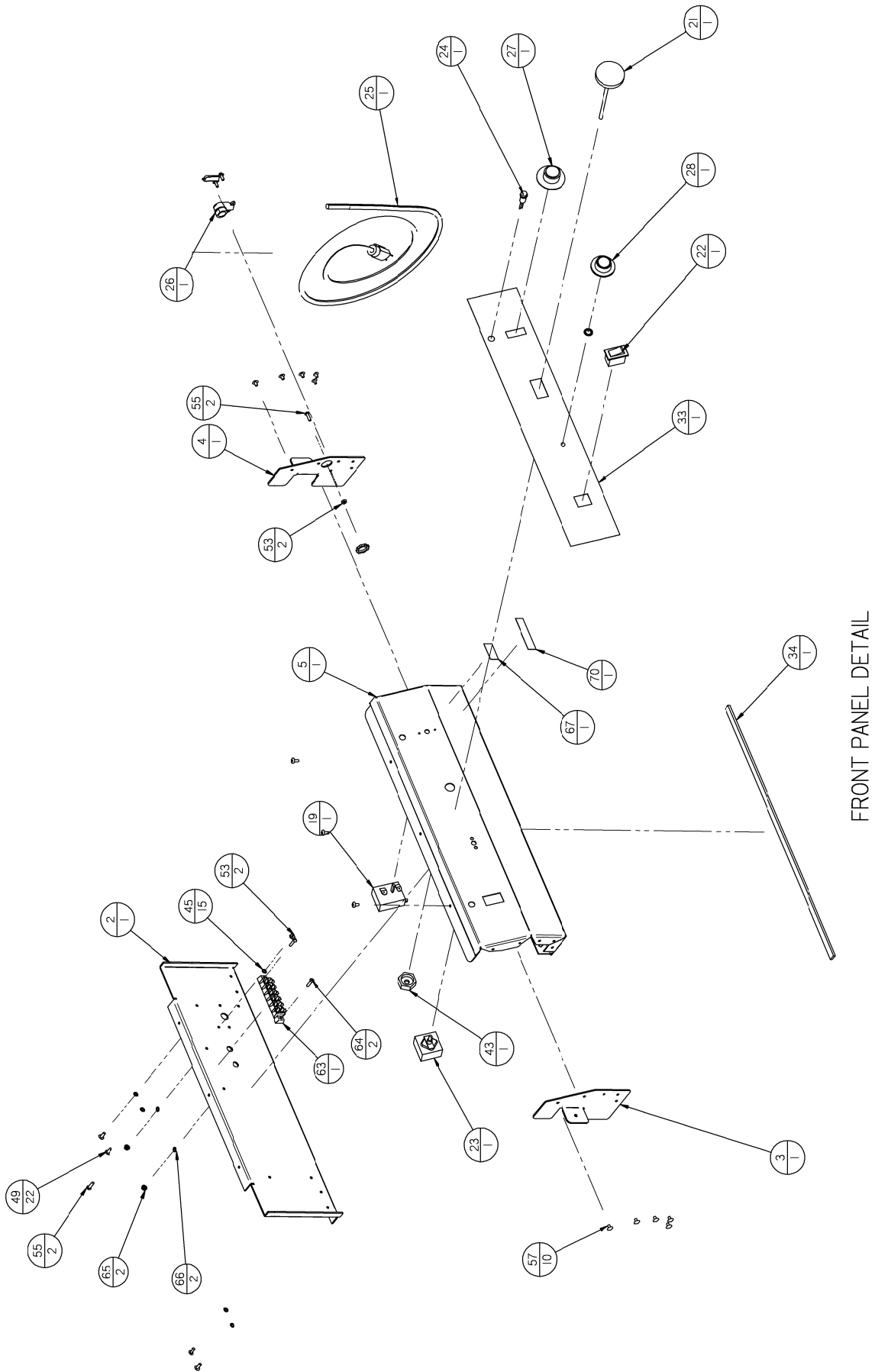

HUMIDITY-HEATING MODULE PARTS DIAGRAM (cont.)

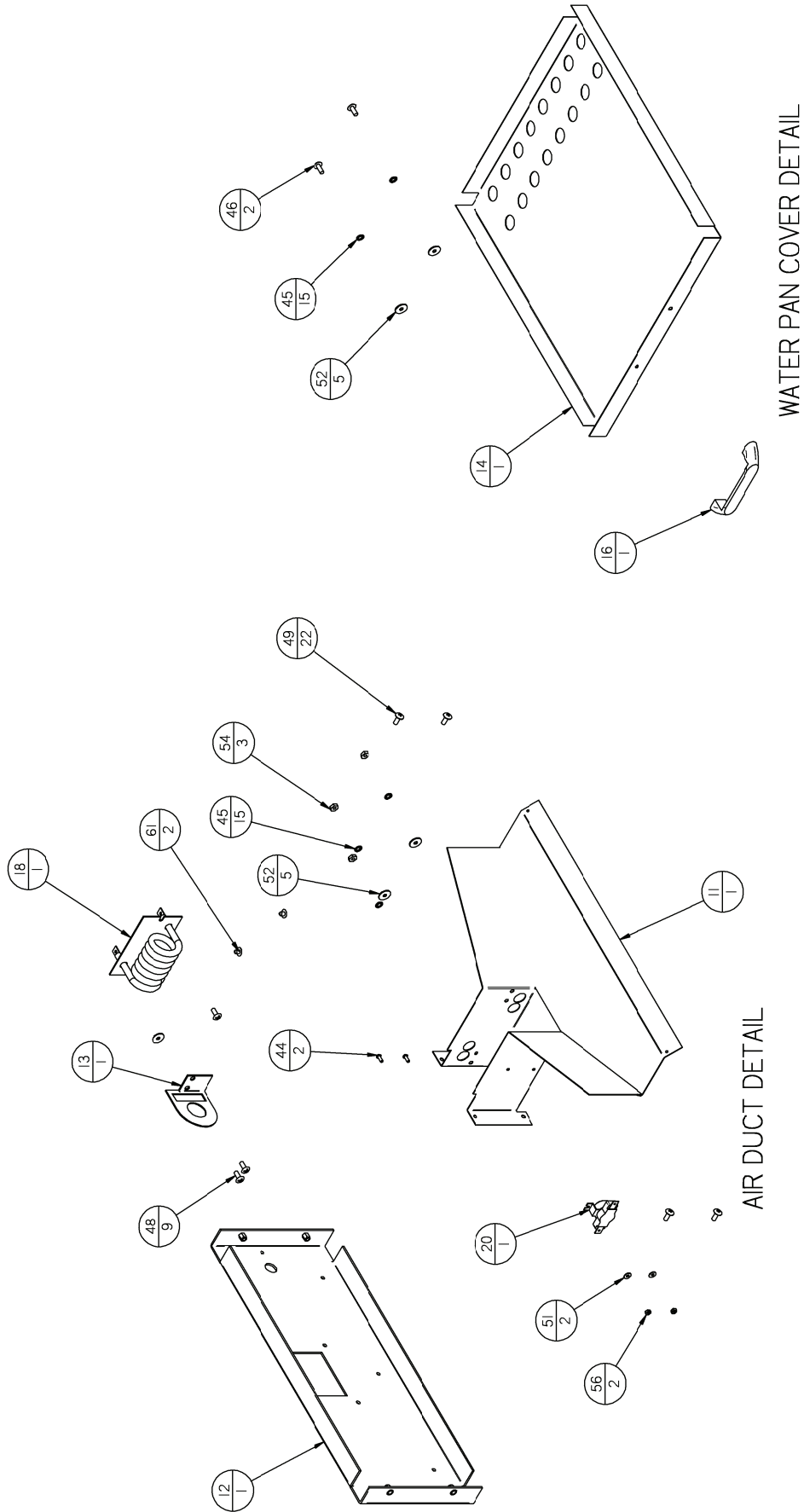

HUMIDITY-HEATING MODULE DIMENSIONS

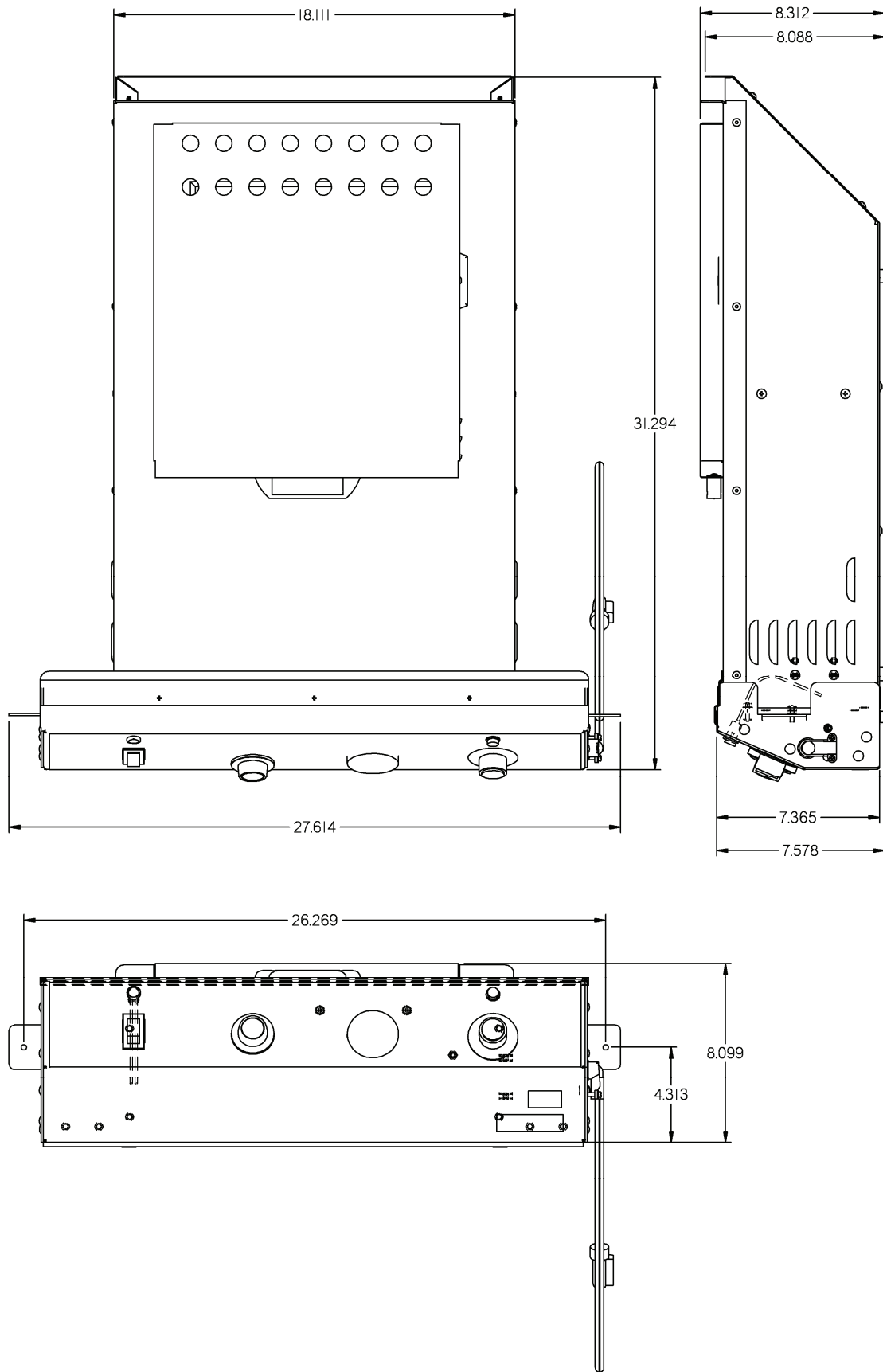



BEVLES COMPANY LIMITED WARRANTY

729 Third Avenue * Dallas, TX 75226

Phone: +1 (214) 421-7366 Fax: +1 (214) 565-0976

1. BevLes warrants to the original purchaser that on the date the equipment is shipped (sold), it will be free of defects in materials or workmanship. BevLes will, at its discretion, repair or replace, during the warranty period printed below, any part that has a defect in material or workmanship that was present when the product shipped from BevLes, and which manifests itself during the warranty period under normal use and service.
 - Parts: Two* years from date of original shipment from the BevLes factory.
 - Labor: One** year from date of original shipment from the BevLes factory.

* Air Circulation Blower Assemblies (motors) and Power Switches shall be one year from date of original shipment.

Calrod "Air" Heating Elements shall be three years from date of original shipment.

** All electrical components 120 days from date of original shipment.
2. BevLes must be contacted, and pre-approval must be issued by the BevLes factory prior to any type of service being performed. BevLes assumes no responsibility for any charges that were not expressly authorized by the BevLes factory, or for any charges that exceed, in BevLes' sole judgement, normal and customary amounts.
3. BevLes will pay UPS Ground charges for any part that has a defect in material or workmanship that was present when the product shipped from BevLes, and which manifests itself during the **first year** of the warranty period under normal use and service. All warranty replacement parts will ship F.O.B. BevLes factory, Cheyenne, WY 82007.
4. This warranty shall be void in its entirety if any abuse of, misuse of, alteration/modification of or improper maintenance of original product occurs. If, at any time a claim is reported to BevLes, and the purchaser is delinquent in payment for the product, warranty will not apply.
5. Buyer's Remedies-If a BevLes product fails due to a defect in material or workmanship in conformity with the warranties in paragraph one, buyer shall notify BevLes of such failure within a reasonable time, but in no event beyond fifteen (15) days of such discovery of defect in material or workmanship. BevLes shall provide, in its sole discretion, either the repair or replacement of any defective or any non-conforming part. BevLes specifically disavows any other representation, warranty or liability relating to the continued use of the product.
6. Exclusion of consequential and incidental damages-In no event shall BevLes be liable for any incidental, special, indirect, or consequential damages, whether resulting from non-delivery or from the use, misuse, or inability to use the product, or from defects in the product, or from BevLes' own negligence or other tort. This exclusion applies regardless of whether such damages are sought for breach of warranty, breach of contract, negligence, or strict liability in tort or under any other legal theory.
7. Disclaimer of warranties-The warranties contained in paragraph one above are the exclusive warranties given by BevLes and supersede any prior, contrary, or additional representations, whether oral or written. BevLes hereby disclaims and excludes all other warranties-whether expressed, implied, or statutory-including any warranty of merchantability, any warranty of fitness for a particular purpose, and any implied warranties otherwise arising from course of dealing or usage of trade.