

VERTICAL CRISP N' HOLD FOOD HOLDING STATION MODEL: VCNH212S-2T OWNERS / OPERATORS MANUAL



READ THIS MANUAL
COMPLETELY BEFORE
OPERATING THIS
APPLIANCE



MANUFACTURED BY:

CARTER-HOFFMANN
1551 McCormick Avenue
Mundelein, IL 60060 U.S.A.

Phone: 847-362-5500
Fax: 847-367-8981
Toll Free: 800-323-9793

Email: TechnicalService@Carter-Hoffmann.com



VCNH212S-2T

TABLE OF CONTENTS

SAFETY PRECAUTIONS.....	2
FEATURES & SPECIFICATIONS.....	3
UNPACKING AND INSPECTION.....	4
INSTALLATION & START-UP.....	5
NORMAL OPERATION	6
CONTROLLER PROGRAMMING.....	7-11
DAILY CLEANING PROCEDURES.....	12
WIRING DIAGRAMS.....	13-14
PARTS LISTS & TROUBLESHOOTING GUIDE	14-15
WARRANTY STATEMENT.....	16

SAFETY PRECAUTIONS



WARNING: ELECTRIC SHOCK HAZARD

All service requiring access to non-insulated components must be performed by qualified service personnel. Failure to heed this warning may result in severe electric shock.



CAUTION: ELECTRIC SHOCK HAZARD

Disconnect this appliance from electrical power before performing any maintenance or service.



CAUTION: BURN HAZARD

Exposed metal surfaces can be hot to the touch and may cause burns.

IMPORTANT SAFETY INSTRUCTIONS

When using electrical appliances basic safety precautions should be adhered to, including the following:

- 1) Be familiar with the appliance use, limitations and associated restrictions. Operating instructions must be read and understood by all persons using or installing this appliance.
- 2) This appliance must be grounded. Connect only to properly grounded outlet.
- 3) Use this appliance only for its intended use as described in the manual.
 - a. This equipment is specifically designed to hold pre-cooked food at temperature.
 - b. This equipment is intended for use in commercial establishments only.
 - c. This equipment is not designed for industrial or laboratory use.
- 4) Cleanliness of this appliance and accessories is essential to good sanitation.
- 5) DO NOT submerge this appliance in water. This appliance is not jet stream approved. DO NOT direct water jet or steam jet at this appliance, or at any control panel or wiring. DO NOT splash or pour water on, in or over any controls, control panel or wiring. DO NOT use corrosive chemicals or vapors in this appliance.
- 6) DO NOT store this appliance outdoors. DO NOT use this product near water – for example, near a kitchen sink, in a wet basement, or near a swimming pool, and the like.
- 7) DO NOT operate this appliance if it has a damaged cord or plug, if it is not working properly, or if it has been damaged or dropped. Do not immerse cord or plug in water, keep cord away from heated surfaces, and do not let cord hang over edge of table or counter.
- 8) **Only qualified service personnel should service this appliance.**
- 9) DO NOT cover or block any openings on the appliance.

NOTE:

The technical content of this manual, including any wiring diagrams, schematics, parts breakdown illustrations and/or adjustment procedures, is **intended for use by qualified technical personnel** and is subject to change without notice.

FEATURES & SPECIFICATIONS



Forced Convection Food Holding Cabinet

The Vertical Crisp n' Hold provides a heated stream of air to maintain crispy or fried food temperature and freshness for a specified period of time after cooking. Forced air is heated through an electric resistance heater and ducted into cabinet interior. The heated air is discharged through small circular openings in the bottom and sides of the cabinet interior caddy, which is removable. A plenum on the front of the cabinet aids in directing a warm blanket of air over the food. Pans rest on wire rods built into the cabinet.

Model Number	Capacity		Dimensions			Shipping Weight Lbs (kg)
	1/3 size steam table pan 6.75" x 12.5" x 2.5"	1/2 size sheet pan 13" x 18"	Height in (mm)	Depth in (mm)	Width in (mm)	
VCNH212S-2T	6 (3 per shelf)	2 (one per shelf)	20-1/4 (514)	18-1/8 (490)	24-5/8 (625)	50 (27)

Capacity/Dimensional Characteristics

Cabinet Material: All stainless steel cabinet construction. Modular design with one controller featuring single temperature control and six timers.

Controls: Electronic temperature control with six timers. Allows user to program temperature in one degree increments up to 275° F (135°C). Timers can be set for up to 9 hours, 59 minutes, in 1 minute increments. Countdown converts to seconds when less than one minute is left. Alphanumeric displays. Cabinet can be custom programmed for time and temperature for new menu items. USB port for uploading and downloading new menu items.

Heater System: Dual fan heating system with electronic temperature control. On/off toggle switch with rubber boot. Blower system with precision engineered air venting in back and bottom, along with front mounted plenums at top provide even air circulation throughout cabinet. Electrical components isolated away from vapors and oils.

Performance: Capable of heating to 275°F (135°C). Minimum set temperature of 200°F (93°C)

Available in both 120v and 240v electrical configuration

Specifications subject to change through product improvement and innovation.

UNPACKING AND INSPECTION



This appliance should be thoroughly cleaned prior to use.

See the **CLEANING INSTRUCTIONS**, on page 9 of this manual.

NOTE: DO NOT discard the carton or other packing materials until you have inspected the appliance for hidden damage and tested it for proper operation.

Refer to *SHIPPING DAMAGE CLAIM PROCEDURE* on bottom of this page.

1. Remove the cabinet from shipping carton, ensuring that all packing materials and protective plastic has been removed from the unit. Inspect all components for completeness and condition.
2. If any freight damage is present, a freight claim must be filed immediately with the shipping company.
3. **Freight damage is not covered under warranty.**
4. Check to insure all components are included; cabinet, instruction packet, six (6) pans and wire grates, and any additional accessories.
5. Read operation instructions completely.
6. Connect power cord to grounded and properly wired electrical source as specified. Electrical specifications are indicated on the serial tag on the cabinet (see sample tag below).
7. Appliance should be thoroughly cleaned before use. See **CLEANING INSTRUCTIONS**, page nine.

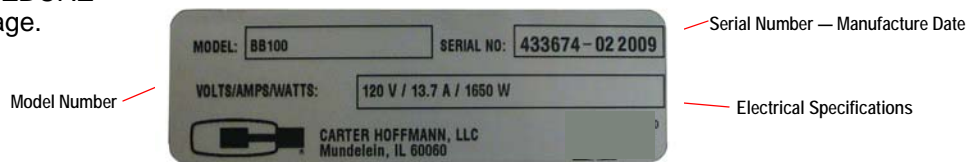

FREIGHT DAMAGE PROCEDURE

NOTE: For your protection, please note that equipment in this shipment was carefully inspected and packaged by skilled personnel before leaving the factory. Upon acceptance of this shipment, the transportation company assumes full responsibility for its safe delivery.

IF SHIPMENT ARRIVES DAMAGED:

1. **VISIBLE LOSS OR DAMAGE:** Be certain that any visible loss or damage is noted on the freight bill or express receipt, and that the note of loss or damage is signed by the delivery person.
2. **FILE CLAIM FOR DAMAGE IMMEDIATELY:** Regardless of the extent of damage. **Contact your dealer immediately.**
3. **CONCEALED DAMAGE:** If damage is unnoticed until the merchandise is unpacked, notify the transportation company or carrier immediately, and then file a "CONCEALED DAMAGE" claim with them. This should be done within fifteen (15) days from the date the delivery was made to you. **Be sure to retain the container for inspection.**

Carter-Hoffmann cannot assume liability for damage or loss incurred in transit, **freight damage is not covered under warranty.** We will, however, at your request, supply you with the necessary documents to support your claim.

INSTALLATION & START-UP



WARNING: Risk of personal injury

Installation procedures must be performed by a qualified technician with full knowledge of all applicable electrical codes.

Failure can result in personal injury and property damage.



IMPORTANT: Power cord is 6' long.

If necessary, contact a licensed electrician to install an appropriate electrical circuit with correct NEMA receptacle. See serial tag on cabinet for electrical specifica-



CAUTION: Electrical Shock Hazard

The ground prong of the power cord is part of a system designed to protect you from electric shock in the event of internal damage.

DO NOT cut off the large round ground prong or twist a blade to fit an existing receptacle.



IMPORTANT: Not under warranty:

Damage to unit due to being connected to the wrong voltage or phase is **NOT** covered by warranty.



CAUTION: Risk of personal injury

Unit is not waterproof, to avoid electrical shock keep unit and counter from being submerged in water. Do not operate if unit has been submerged in water.

Location

For proper operation and maximum performance, locate the Crisp n' Hold in an ambient air temperature of 70° F (21°C).

Avoid areas near exhaust fans where there is active air movement. For safe operation, locate the unit a reasonable distance from combustible walls and materials.

To prevent injury and damage, locate the unit at a proper and safe working height. The location should be level, clean of debris, and strong enough to support the weight of a fully loaded unit.

To prevent electrical shock, be sure unit is unplugged from an electrical outlet. If unit has been operated, allow unit to cool before installing.

GROUNDING INSTRUCTIONS

This appliance is equipped with a cord having a grounding wire with a grounding plug which must be plugged into an outlet that is properly installed and grounded. In the event of an electrical short circuit, grounding reduces the risk of electric shock by providing an escape wire for the electric current.

WARNING—Improper use of the grounding can result in a risk of electric shock. Consult a qualified electrician or serviceman if the grounding instructions are not completely understood, or if doubt exists as to whether the appliance is properly grounded.

To prevent an electrical shock hazard between the appliance and other appliances or metal parts in close vicinity, an equalization-bonding stud is provided. An equalization bonding lead must be connected to this stud and the other appliances/metal parts to provide sufficient protection against potential difference. The terminal is marked with the following symbol:



Start-up

1. Plug the cabinet into a properly grounded electrical receptacle.
2. Ensure all plastic and packaging materials have been removed.
3. Set POWER SWITCH to "ON" position.
4. Do not load product into the cabinet. Allow the heat to remove any residual oils which may adhere to inside metal surfaces. A slight emission of smoke is normal for the first few hours of operation.
5. Appliance is preset at the factory. However, the temperature is adjustable. See pages 7-10 for programming instructions.

NORMAL OPERATION

MOIST FOOD HOLDING: Use with pan cover in place.

CRISPY / FRIED FOOD HOLDING: Use bottom and top heat and remove pan cover.

TEMPERATURE SETPOINT RANGE:
200°F - 275°F
(93°C - 135°C)

TIMER RANGE:
1 minute to 9 hours, 59 minutes.

NOTE: Timers cannot be programmed for less than 1 minute.



Temperature is LOW



Typical temperature reading



Typical Time Remaining reading



Timed Cycle Completed

NOTE: Timer cannot be started until the cabinet is pre-heated.



NOTE: Press and release



the TEMP KEY  to view or verify a cavity setpoint. Cavity setpoint will be displayed briefly. If the cavity setpoint needs to be changed, refer to *Programming Instructions* on page 7-10.

NOTE: Timer can be cancelled at any time during the cycle by pressing and holding the

TIME KEY  for 2 seconds. Digital readout will display currently selected menu item (i.e. "MST1").

1. Turn POWER SWITCH, located at the top front panel, to ON. When first turned on, digital readout will boot up and display the software codes and then "LO" until the cabinet reaches 122°F (50°C). After the cabinet reaches 122°F (50°C), the digital readout will display the current temperature, until the temperature reaches the set point. Once the cabinet reaches set point, the digital readout will display the current menu item for each pan (i.e. "BACN"). This indicates the cabinet is ready to hold product.

You may change the menu item by pressing the  UP and  DOWN ARROW KEYS. Each controller has five pre-set programs (BACN, BIG, PIES, FISH, SPCY, LT01, LT02 and OFF) for each pan position. In the OFF position, temperature set point and time cannot be modified.

2. Load cooked product into pans and place pans on shelves. For moist food holding, use with pan covers in place; bottom; For crispy food holding, remove pan covers.
3. Press TIME KEY  to start the timer. Refer to *Programming Instructions* (page 7) to change programmed time.
4. When the timer button is pressed, the display will show the time for 5 seconds and then return to the menu item. LED label top heat will indicate the time remaining as it counts down. The digital readout will count down, displaying the remaining time. The digital readout is displayed in hours and minutes until less than one minute remains. Once the remaining time is less than one minute, the digital readout counts down in seconds. At the end of the timed cycle, the digital readout will flash "0.00" and an alarm will sound until the TIME KEY  is pressed.
5. Remove product from cabinet.
6. At the end of the day, or if the cabinet will not be used for an extended period of time, press the POWER SWITCH to OFF.

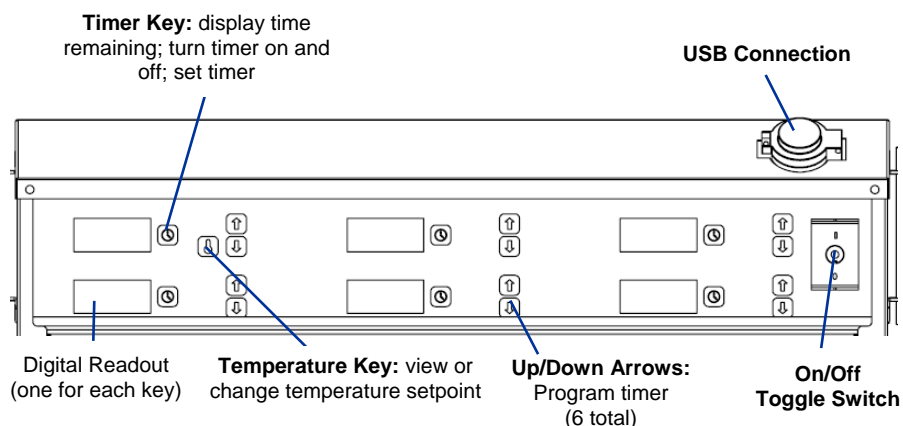

CONTROLLER PROGRAMMING

NOTE: Each timer can be programmed individually.

TEMPERATURE SETPOINT RANGE:
200°F - 275°F
(93°C - 135°C)

TIMER RANGE:
1 minute to 9 hours, 59 minutes.

NOTE: Timers cannot be programmed for less than 1 minute.

Default Temperature Setting: 235°F



Default Timer Settings

Item	Time
OFF	-
BACN	0:30
SPCY	0:30
BIG	0:30
PIES	0:30
FISH	0:30
LT01	0:30
LT02	0:30





PROGRAMMING INDIVIDUAL HEATER TEMPERATURE SETPOINTS (Programs: BACN, SPCY, BIG, PIES, FISH, LT01, LT02)

1. You can change the temperature setting for the cabinet.

Press and hold the TEMP KEY  on the upper left for approximately 2 seconds, the display will flash the current setting for the lower heater.

2. Press either INCREASE KEY  or DECREASE KEY  to change the temperature.
3. When done, press and hold the TEMP KEY  for 2 seconds. Changes will be saved. If no button is pressed, controller will automatically exit and changes will be saved.

PROGRAM TIMERS (for each menu item)

1. Press and hold TIME KEY  until digital readout flashes.
2. Press INCREASE KEY  to add time. Each time key is pressed, timer is increased by 1 minute. Hold key to scroll faster.
3. Press DECREASE KEY  to subtract time. Each time key is pressed, timer is decreased by 1 minute. Hold key to scroll faster.
4. Press TIME KEY  to save changes and return to the menu item.

NOTE: If no key is pressed for 5 seconds, display returns will display the menu item. Changes will be saved.

NOTE:

The technical content of this manual, including any wiring diagrams, schematics, parts breakdown illustrations and/or adjustment procedures, is intended for use **ONLY by qualified technical personnel.**

CONTROLLER PROGRAMMING

TO CHANGE PROGRAM SETTINGS USING USB PORT

The cabinet comes with a USB port and a flash drive equipped with the software to change the menu settings and upload to or download from the cabinet.

1. Insert the USB drive into your computer and locate the **CarterHoffmannAlpha.exe** file.
2. Click on the **CarterHoffmannAlpha.exe** to run the program. If a dialog box asks you if you are sure you want to run, click "yes".
3. A Data input screen will open and you may now change the settings for each pan or each menu item.
4. **Select Model for your cabinet** at the bottom right of the **Drawer Setup** tab. The drawer set-up display should then show two levels. These coincide with pan locations.
5. There are two tabs for the data input screen:

Drawer Setup: This screen allows you to select from the programmed menu items for the cabinet. There are 17 default menu items: BACN, SSG, HAM, TSSG, SMK, CKN, STK, FRD, VEW, HASH, CSP1, MST1, CSP2, MST2, CSP3, MST3 and OFF. You can program the heat for the cabinet.

Program Setup: This screen allows you to change the menu item names and timer for each menu item.

Shown with
Default settings

Program heat for the
cabinet. Default is
235°F.

4) Select Model
212

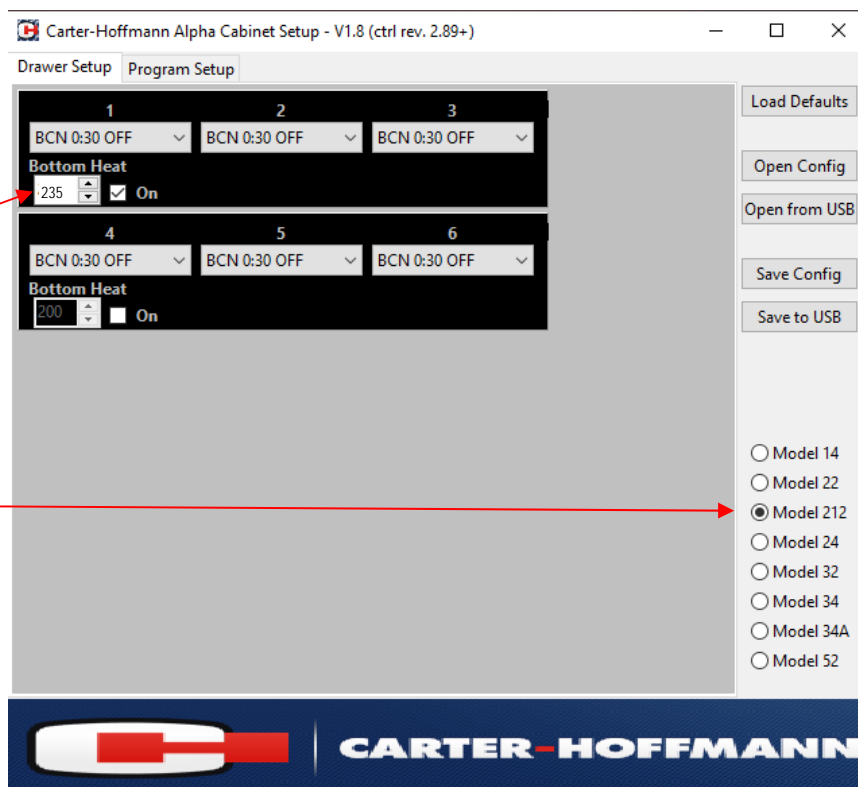

Open Config: Browse to find and open a previously saved menu configuration from your computer.

Open from USB: Browse to find and open a previously saved menu configuration from the USB drive.

Load Defaults: Click to override any menu settings that have been save to the original factory defaults.

Save Config: Save file to a location on your computer

Save to USB: Save file to a USB (USB can then be used to upload new settings using the port on the cabinet)

THE FILE WILL BE A TEXT FILE NAMED CONFIG

CONTROLLER PROGRAMMING (continued)

TO CHANGE THE MENU ITEM AND TIMER FOR EACH PAN

There are 17 default menu items: BACN, SSG, HAM, TSSG, SMK, CKN, STK, FRD, VEW, HASH, CSP1, MST1, CSP2, MST2, CSP3, MST3 and OFF. If you wish to change the menu item, click on the **Drop-Down Arrow** for the pan slot and select a new menu item. You may do this for each pan.

Drop-Down Arrow to select menu item

Program heat for cabinet
Default is 235°F.

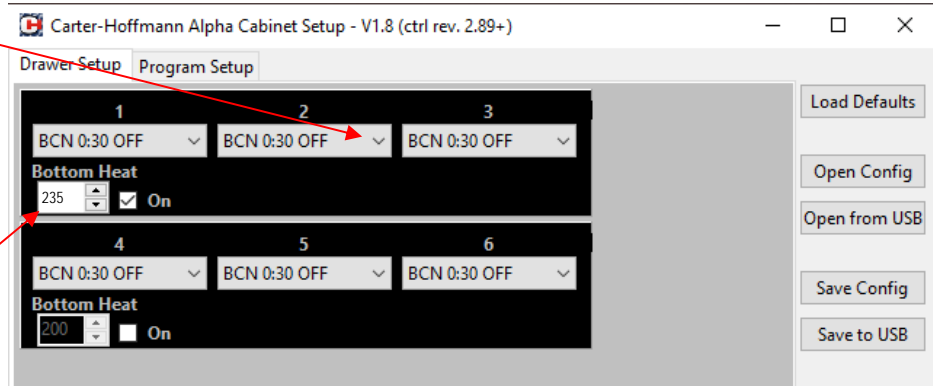

TO CHANGE MENU ITEM NAME, TEMPERATURE SETTING AND/OR TIME SETTINGS

On the data input screen, select the **Program Setup** tab then **Select Model for your cabinet** on the lower right.

On this screen you can see the time settings for each menu item. There are five default menu items that are preprogrammed, but you can designate settings for up to 25 menu items. P0 (OFF) cannot be changed. P1 through P25 can have unique programmed settings for the menu item name (alphanumeric—up to four characters), time (maximum is 9 hours, 59 minutes), top heat on or off (click box next to On if you wish to have the top heater activated; maximum temperature for top heat is 275°F)

Default Settings

Item	Time	Item	Time
OFF	-	VEW	0:30
BACN	0:30	HASH	0:30
SSG	0:30	CSP1	0:30
HAM	0:30	MST1	0:30
TSSG	0:30	CSP2	0:30
SMK	0:30	MST2	0:30
CKN	0:30	CSP3	0:30
STK	0:30	MST3	0:30
FRD	0:30		

Program Setup

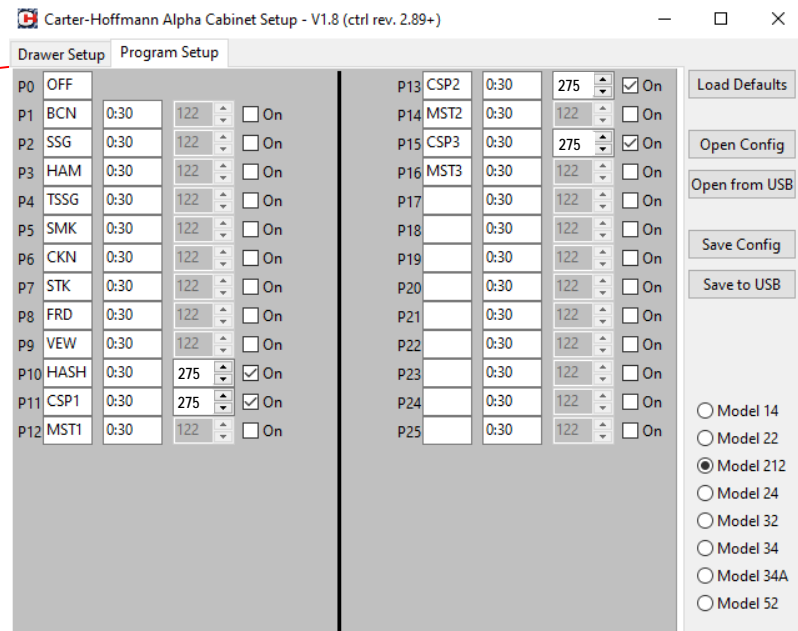

CONTROLLER PROGRAMMING (continued)

SAVING YOUR CHANGES

The top screenshot shows the 'Program Setup' screen with a list of drawers (P0-P25) and their settings. The bottom screenshot shows a detailed view of the 'Bottom Heat' settings for drawers 1-6. Red arrows point from the 'Save to Computer' and 'Save to USB' buttons in the top screenshot to the corresponding buttons in the bottom screenshot.

When you are finished making changes, you may save the new settings to the flash drive and your computer. This can be done from the **Drawer Setup** or **Program Setup** Screen.

Save the new settings to the flash drive by clicking on the **“Save to USB”** button. It is recommended that you save the settings to your computer in a secure spot, for backup just in case the flash drive is lost or destroyed. Save the settings to your computer by clicking on the **“Save Config”** button. This .txt file will be named CONFIG and contains the data settings that you have just programmed, using the **CarterHoffmannAlpha.exe** software.

NOTE: The new settings will overwrite any existing files on your computer and/or the flash drive.

Other options from this screen are:

“Open Config”: Opens a previously saved menu configuration from your computer

“Open from USB”: Opens a previously saved menu configuration from the flash drive

“Load Defaults”: Click to override any menu settings that have been save to the original factory defaults.

CONTROLLER PROGRAMMING (continued)

UPLOADING and DOWNLOADING MENU SETTINGS USING THE USB PORT

See page 11 for Default Factory Settings

UPLOADING FROM FLASH DRIVE VIA USB PORT TO CABINET

1. The unit must be plugged in and the power must be turned OFF prior to beginning this procedure.
2. Insert the flash drive into the USB port and turn the cabinet ON. Observe the top far left display.
3. Before the display shows **PUP** **KEY** **CHK** press and hold **TIMER** and **UP ARROW** buttons.
4. When the display reads **CHEK** **USB** **STIK** the settings have been uploaded.
5. The programming is complete and the settings will read “Lo.”
6. Turn the power off and remove the flash drive.

DOWNLOADING FROM THE CABINET TO THE FLASH DRIVE VIA THE USB PORT

1. The unit must be plugged in and the power must be turned OFF prior to beginning this procedure.
2. Insert the flash drive into the USB port and turn the cabinet ON. Observe the top far left display
3. Before the display shows **PUP** **KEY** **CHK** press and hold **TIMER** and **DOWN ARROW** buttons.
4. When the display reads **SAVE** **USB** **STIK** the settings have been downloaded.
5. The programming is complete and the settings will read “Lo.”
6. Turn the power off and remove the flash drive.

NOTE:

If the controller reads:

OFF
nOF iLE

And the settings cannot be downloaded, check your flash drive and make sure the filed names CONFIG.TXT is not placed in a folder.

NOTE:

The technical content of this manual, including any wiring diagrams, schematics, parts breakdown illustrations and/or adjustment procedures, is intended for use **ONLY by qualified technical personnel.**

TO CHANGE THE TEMPERATURE SCALE

Press the TEMP KEY  until the temperature starts flashing. Then, press both the up and down arrow buttons (together) until 'F' (Fahrenheit) is displayed.

Press the up or down arrow keys to toggle between °C and °F.

Once selected, press the TEMP KEY  to save and exit.

CLEANING PROCEDURES



CAUTION: ELECTRIC SHOCK HAZARD

Disconnect appliance from electric power before cleaning.



CAUTION: HOT SURFACE

Exposed surfaces can be hot to the touch and may cause burns. Allow appliance to cool before cleaning.

IMPORTANT: DO NOT spill or pour water into controls, control panel or wiring. Water damage is **not** covered by warranty.



CAUTION: Beware of sharp edges on sheet metal during cleaning, especially during removal of grease filters.

1. After all food products have been removed from the cabinet, turn the POWER SWITCH to "OFF" and allow the cabinet to cool. Unplug cabinet.
2. Clean pans with a mild detergent. Rinse and allow to air dry. (The pans and caddy may be run through a commercial dishwasher).
3. Wipe cabinet and inside surface of warming cavity with a clean towel moistened with cleaning solution (see Recommended Tips below). Take care not to get moisture into any vents, internal controls or electrical components.
4. Rinse by wiping with a clean towel moistened with clean water. Allow to air dry.
5. Inspect and clean the areas where there are vents, making sure no water gets into the internal controls or electrical areas of the cabinet.



CAUTION

Cleansers, detergents, degreasers, sanitizers, or bleaching agents that contain chlorides or phosphates will cause permanent damage to stainless steel products. The damage appears as pits, eruptions, voids, small holes, severe discoloration or dulling of the metal finish. Water with high chloride content can also damage stainless steel. If unsure of your water quality, we recommend you have it tested. **THIS DAMAGE IS PERMANENT, COSTLY TO REPAIR, AND IS NOT COVERED BY THE WARRANTY.**

RECOMMENDED TIPS FOR CLEANING STAINLESS STEEL

<u>Purpose</u>	<u>Frequency</u>	<u>Cleaning Agent</u>	<u>Method of Application</u>
Routine	Daily	Soap, ammonia detergent and water	Sponge with cloth, rinse with clear water cleaning and wipe dry.
Smears/ Fingerprints	As needed	Stainless steel cleaner or similar products	Rub with soft cloth as directed on package. Rub in direction of grain of stainless steel. Do not use on vinyl trim.
Stubborn spots and stains	Daily as needed	Any chloride-free or phosphate-free cleaner	Apply with damp sponge or cloth. Rub in direction of grain of stainless steel. Rinse thoroughly, especially if cleaner contains chlorine bleach, do not use on vinyl trim.
Hard water spots	Daily as needed	Vinegar	Swab with cloth. Rinse with water and wipe dry.

WIRING DIAGRAM

Electrical Characteristics: 120 volts

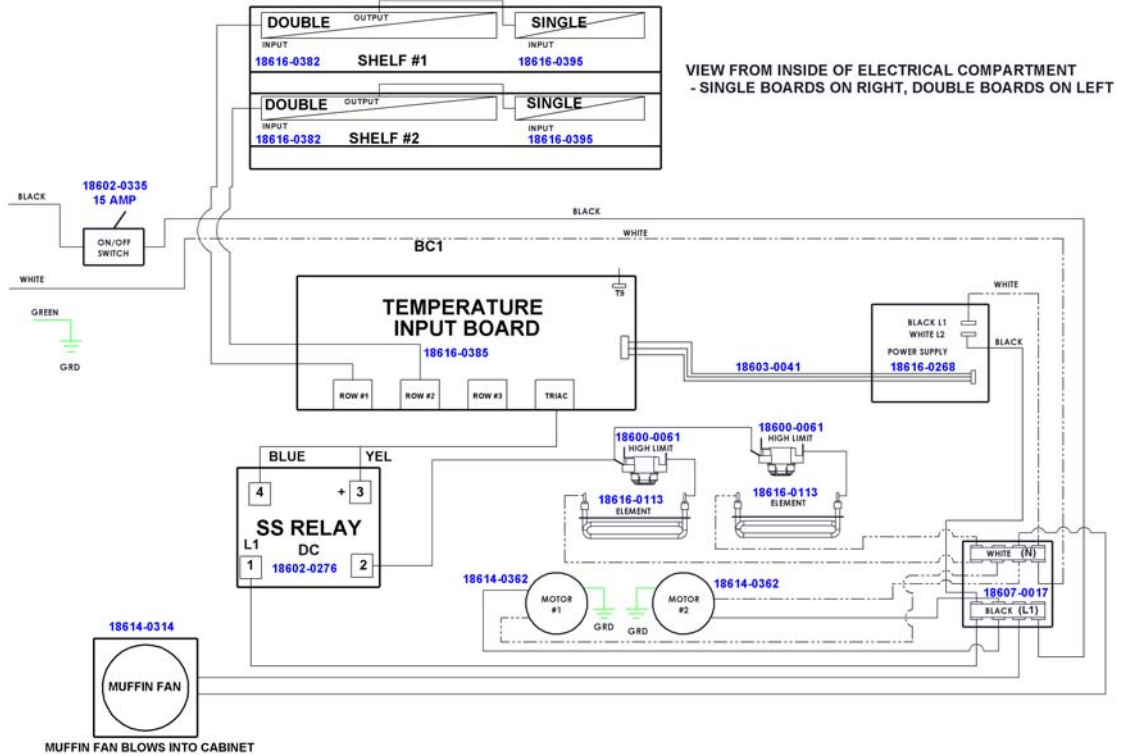

VIEW FROM INSIDE OF ELECTRICAL COMPARTMENT
- SINGLE BOARDS ON RIGHT, DOUBLE BOARDS ON LEFT

MUFFIN FAN BLOWS INTO CABINET

*USE PROGRAM VCNH

WIRING DIAGRAM (continued)

Electrical Characteristics: 208-240 volts

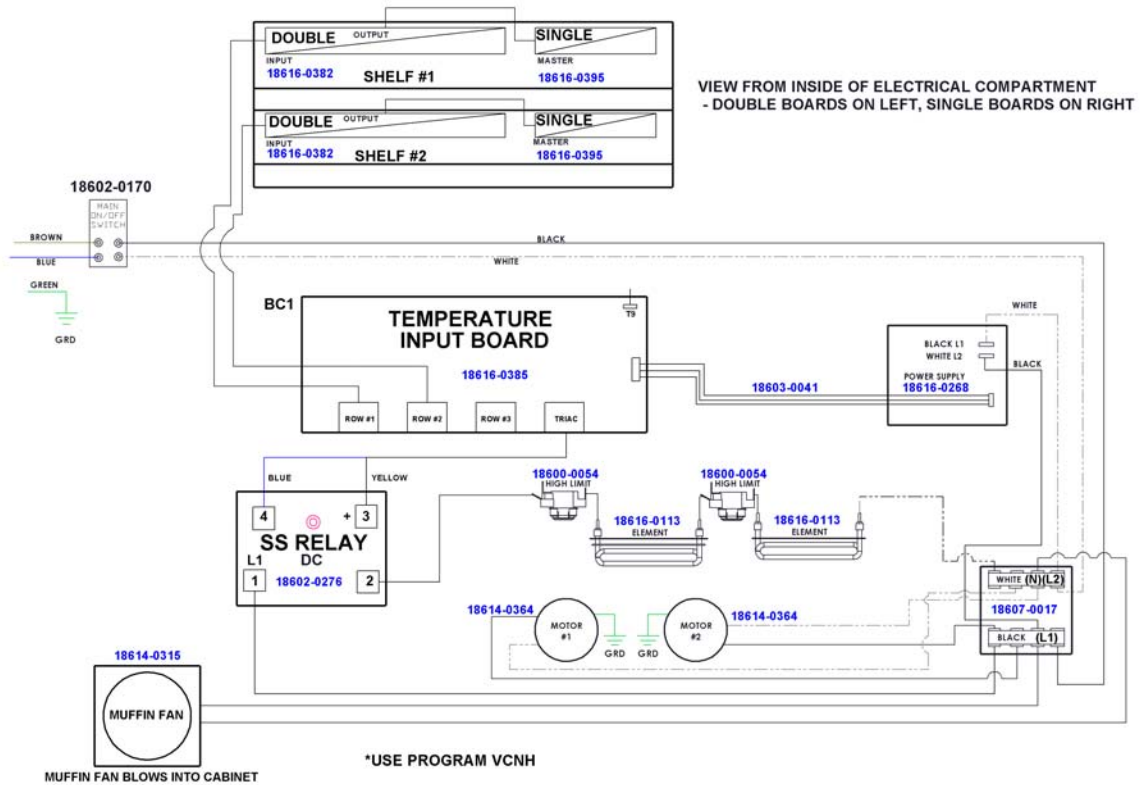

PARTS LISTS

VCNH212S-2T
Vertical Crisp 'N Hold Station
120v, 1820 watts, 15.1A, 60Hz, 1Ph

Part Number	
18305-0071	Rubber foot
18312-0687	Controller label
18600-0061	Hi-limit thermostat
18602-0335	On/Off switch
18602-0171	Switch boot
18602-0276	Solid state relay—25A
18614-0042	Fan wheel
18603-9099	18" Thermistor probe
18605-0040	Cord 14/3 SJO X 6' long, NEMA 5-20P plug
18612-0113	Heater elements, 110v 900w
18614-0314	Muffin fan
18614-0362	Motor w/ bracket 110v
18616-0268	Power supply
18616-0385	Temperature controller
18616-0395	Single display
18616-0382	Dual display
16504-5931	Pan cover
18607-0017	Terminal block

VCNH212S-2T
Vertical Crisp 'N Hold Station
208-240v, 1820 watts, 7.6A, 50/60Hz, 1Ph

Part Number	
18305-0071	Rubber foot
18312-0687	Controller label
18600-0054	Hi-limit thermostat
18602-0170	On/Off switch
18602-0171	Switch boot
18602-0276	Solid state relay—25A
18614-0042	Fan wheel
18603-9099	18" Thermistor probe
18605-0200	16/3 SJO cord x 6' long, 6-15P plug
18612-0113	Heater elements, 110v 900w
18614-0315	Muffin fan
18614-0364	Motor w/ bracket 240v
18616-0268	Power supply
18616-0385	Temperature controller
18616-0395	Single display
18616-0382	Dual display
16504-5931	Pan cover
18607-0017	Terminal block

TROUBLESHOOTING GUIDE

SYMPTOM	POSSIBLE CAUSE	SUGGESTED REMEDY
No power to unit	Not plugged in or circuit breaker tripped	Check or reset circuit breaker Connect to proper receptacle
	Power cord damaged	Check - replace if required
	Power switch damaged or defective	Check - replace if required
Food dries out quickly	Operation where product temp is too high	Check product temps going into holding cabinet
	Temperature probe or controller defective	Check proper operation or call service technician
Unit is on, motors are running but no heat	Internal wiring error	Call service technician
	Element hi-limit trip /defective	Call service technician
Takes too long to get to temperature	Improper voltage	Call service technician to verify incoming voltage matches cabinet specifications.
Unit is hot but low or no airflow	Internal wiring error	Call service technician
	Circulation motor has quit	Call service technician
	Improper voltage	Call service technician to verify incoming voltage matches cabinet specifications.

NOTE:

The technical content of this manual, including any wiring diagrams, schematics, parts break-down illustrations and / or adjustment procedures, is **intended for use ONLY by qualified technical personnel.**

NOTE:

For warranty service, call Carter-Hoffmann direct at 800-323-9793 for authorization, we will dispatch the nearest authorized service agency.

WARRANTY STATEMENT

Carter-Hoffmann Warranty:

Carter-Hoffmann ("CARTER-HOFFMANN") warrants to the initial purchaser of its standard Carter Line Products that CARTER-HOFFMANN will, at its option, repair or replace, during the warranty period set forth below, any part of such products made necessary due to a defect in material or workmanship which is present when the product leaves its factory and which manifests itself during the warranty period under normal use and service.

*This warranty applies only to original equipment owned and possessed by the initial purchaser and the warranty period begins on the date of original shipment from the CARTER-HOFFMANN factory and extends as follows: **to component parts and labor for 12 months; to refrigeration compressor unit for one year** (limited to replacement only - not to include labor for removal, repair or replacement).*

Repair or replacements under this warranty will be performed, unless otherwise authorized in writing by CARTER-HOFFMANN, at its factory. All parts or components to be repaired or replaced under this warranty are to be shipped prepaid to CARTER-HOFFMANN, with reimbursement credit for such part or component to be given if found by CARTER-HOFFMANN to be defective.

CARTER-HOFFMANN neither makes nor assumes and does not authorize any other person to make or assume any obligation or liability in connection with its products other than that covered in this warranty. This warranty applies only within the continental United States and Canada. In Alaska and Hawaii, this warranty applies only to and is limited to the supply of replacement parts.

Warranty Exclusions and Limitations:

Any implied warranty of merchantability or fitness for a particular purpose is hereby specifically disclaimed by CARTER-HOFFMANN. There are no warranties, expressed or implied, which extend beyond the description on the face hereof. This warranty does not cover and CARTER-HOFFMANN shall not under any circumstances be liable for any incidental, consequential or other damages (such as injury to persons or property, loss of time, inconvenience, loss of business or profits, or other matters not specifically covered) arising in connection with the use of, inability to use, or failure of these products.

Specifications subject to change through product improvement and innovation.

Carter-Hoffmann, LLC

1551 McCormick Ave.

Mundelein, IL 60060

Phone: 847-362-5500 • Toll free (USA and Canada): 800-323-9793

Fax: 847-367-8981

Sales & Marketing E-mail: sales@carter-hoffmann.com

Service E-mail: technicalservice@carter-hoffmann.com

Company Website: www.carter-hoffmann.com

CFESA

Proud Member

NAFEM
North American Association of
Food Equipment Manufacturers