

GARDENCHEF®

HERB AND MICROGREEN GROWING CABINET

Models GC42, GC41, GC12, GC11



MANUFACTURED BY:

CARTER-HOFFMANN
1551 McCormick Avenue
Mundelein, IL 60060 U.S.A.

Phone: 847-362-5500
Fax: 847-367-8981
Toll Free: 800-323-9793

Email: TechnicalService@Carter-Hoffmann.com



GC42



GC12



GC41

PATENT PENDING

TABLE OF CONTENTS

FEATURES AND SPECIFICATIONS	2
UNPACKING AND INSPECTION	3
SAFETY PRECAUTIONS	3-4
INSTALLATION & STARTUP	5-10
SETTING UP YOUR GROWING CYCLES	11
PROGRAMMING CYCLES	12-13
FUNCTIONS OF THE ZONE SCREEN	13
FUNCTIONS OF THE MAIN RESERVOIR SCREEN	13
PLANTING & GROWING	14
GROWING GUIDE	15-16
GROWING TIPS	16
CLEANING AND MAINTENANCE	17-18
PERIODIC MAINTENANCE	19
REPLACING THE LIGHTS	20
SANITATION AND FOOD SAFETY	21
FREQUENTLY ASKED QUESTIONS & TROUBLESHOOTING	22
MICROGREEN PROBLEMS	23
RESOURCES	24-25
REPLACEMENT PARTS, WIRING & PLUMBING DIAGRAMS	26-27
WARRANTY STATEMENT	28

FEATURES AND SPECIFICATIONS

The GardenChef® provides a self-contained environment that is ideal for growing herbs and micro greens. The lights produce the proper spectrum and an irrigation system delivers water and nutrients to the plants. The automated system provides everything the plants need to grow year round and right in the kitchen. It is preprogrammed for the growing needs for common herbs and microgreens. You can customize the growing conditions for other plants as needed.



GC42



GC41

Model Number	Number of Growing Zones	Capacity 10"x20" Trays	Overall Dimensions			Caster Size	Leg Height	Shipping Weight
			Height	Depth	Width			
GC42	8	16	79" (2007 mm)	28-1/4" (718 mm)	66-3/4 (1695 mm)	3" (76 mm)	4" (102 mm)	525 (238 kg)
GC41	4	8	79" (2007 mm)	28-1/4" (718 mm)	37-1/2 (953 mm)	3" (76 mm)	4" (102 mm)	275 (125 kg)
GC12	2	4	33-1/2 (851 mm)	28-1/4" (718 mm)	66-3/4 (1695 mm)	3" (76 mm)	4" (102 mm)	200 (91 kg)
GC11	1	2	33-1/2 (851 mm)	28-1/4" (718 mm)	37-1/2 (953 mm)	3" (76 mm)	4" (102 mm)	160 (73kg)

CONSTRUCTION...Welded & riveted double wall, non-insulated cabinet construction.

CABINET MATERIAL... 430 series stainless steel exterior; 301 series interior with reflective finish

BASE FRAME... 12 gauge stainless steel full depth bolsters.

CASTERS... 3" diameter polyurethane casters. All swivel; front casters fitted with brakes.

LEGS...4" Adjustable legs for leveling

DOORS...Single panel tempered glass doors set in extruded aluminum frame. Magnetic gasket. Full length integrated door handles.

HINGES... Adjustable edge mount hinges with chrome plate finish.

GROWING DRAWERS... Removable growing drawers. Stainless steel construction with drainage holes in rear for ebb and flow irrigation. Each drawer will accommodate two standard 10" x 20" flats with 5" or 7" greenhouse domes for sprouting. Includes one set of growing trays and 5" domes.

Level	Growing Space
1 (top shelf)	9.875"
2	11.5"
3	13"
4 (bottom shelf)	16.75"

CONTROLS...Touchscreen digital controls. Automated system provides correct measures of water, nutrients, relative humidity, lighting on optimum cycle for plant growth and nutrient data. Preprogrammed default settings for most growing needs; programmable for other growing situations. Lock-out access code.

ENVIRONMENT... Digital controls for automatic light, watering schedule and humidity levels for growing. Temperature based on ambient room temperature.

Default Programs:
 Watering Cycle: Once every 4 days
 Watering Time: 5 Minutes
 Daylength: 18 Hours (lights on each day)

WATERING SYSTEM... Automatic filtered pump/aerator irrigation system delivers water and nutrients from the reservoir to the plants. Programmable watering cycle. Auto-fill reservoir. 3/8" NPT fill connection: 3/8" NPT drain connection. pH and TDS (total dissolved solids) sensors.

GROWING LIGHTS... Equipped with 18" T5 high output fluorescent light fixtures. Each fixture includes an integrated electronic ballast, 6400°K lamp with a nano-tech reflector for maximum reflection. Lights imitate the sun's rays for optimum growing. Removable opaque polycarbonate shields. Fully programmable light cycles.

ELECTRICAL CHARACTERISTICS...
 GC42: operates on 120 volts, 4.4 amps.
 GC41: operates on 120 volts, 2.5 amps.
 GC12 operates on 120 volts, 1.4 amps.
 GC11 operates on 120 volts, 1.0 amps.
 All are 60 cycle, single phase. Six foot rubber cord with 3 prong grounding plug. NEMA 5-15P.

ACCESSORIES/OPTIONS...

- Starter kit: includes growing trays, mats, domes, sifter, pH & TDS calibration solutions, hydrogen peroxide, 20 gallon plastic tub, measuring syringe



UNPACKING AND INSPECTION



This appliance should be thoroughly cleaned prior to use.

See the CLEANING INSTRUCTIONS in this manual.

NOTE: DO NOT discard the carton or other packing materials until you have inspected the appliance for hidden damage and checked it for proper operation.

Refer to *SHIPPING DAMAGE CLAIM PROCEDURE* on bottom of this page.

1. Remove the cabinet from shipping carton, ensuring that all packing materials and protective plastic has been removed from the unit.
2. Inspect all components for completeness and condition.
3. If any freight damage is present, a freight claim must be filed immediately with the shipping company.
4. **Freight damage is not covered under warranty.**
5. Check to insure all components are included: cabinet, anchoring straps, instruction packet and additional accessories.
6. Read operation instructions completely.
7. Appliance should be thoroughly cleaned before use. See CLEANING INSTRUCTIONS in this manual.



WARNING: Tipping hazard

Anchor straps **must** be used to secure unit to a wall. Unit **must** be anchored, using straps along with the anchor points located in the upper corners of the back of the unit to structural supports in the wall behind the unit.

CAUTION: Health and safety regulations vary by jurisdiction. Prior to installation, operator must be aware and must comply with all local and state codes, including proper installation, plumbing and electrical hook up, as well as any health certificates that may be required for growing food in your establishment. Carter-Hoffmann assumes no responsibility for improper installation or use of this product or failure to adhere to local regulations.

NOTE: This unit is to be installed with adequate backflow protection to comply with all applicable federal, state and local codes.

FREIGHT DAMAGE PROCEDURE

NOTE: For your protection, please note that equipment in this shipment was carefully inspected and packaged by skilled personnel before leaving the factory. Upon acceptance of this shipment, the transportation company assumes full responsibility for its safe delivery.

IF SHIPMENT ARRIVES DAMAGED:

1. **VISIBLE LOSS OR DAMAGE:** Be certain that any visible loss or damage is noted on the freight bill or express receipt, and that the note of loss or damage is signed by the delivery person.
2. **FILE CLAIM FOR DAMAGE IMMEDIATELY:** Regardless of the extent of damage. **Contact your dealer immediately.**
3. **CONCEALED DAMAGE:** If damage is unnoticed until the merchandise is unpacked, notify the transportation company or carrier immediately, and then file a "CONCEALED DAMAGE" claim with them. This should be done within fifteen (15) days from the date the delivery was made to you. **Be sure to retain the container for inspection.**

Carter-Hoffmann cannot assume liability for damage or loss incurred in transit, **freight damage is not covered under warranty.** We will, however, at your request, supply you with the necessary documents to support your claim.

SAFETY PRECAUTIONS



WARNING: ELECTRIC SHOCK HAZARD

All service requiring access to non-insulated components must be performed by qualified service personnel. Failure to heed this warning may result in severe electric shock.



CAUTION: ELECTRIC SHOCK HAZARD

Disconnect this appliance from electrical power before performing any maintenance or service.

IMPORTANT SAFETY INSTRUCTIONS

For your safety and the proper operation of this appliance, please follow these safety guidelines. This manual should remain with the GardenChef so that new owners and users learn about the product and relevant safety precautions. Carefully read through this manual before installing and using the GardenChef.

- Do not let children operate this appliance. It is designed to be operated by adults. Make sure all users have read this manual thoroughly.
- The water from your GardenChef is not potable and not suitable for drinking.
- Keep your seeds, nutrients and growing media in a safe, clean, dry storage area.

When using electrical appliances basic safety precautions should be followed, including the following:

1. Be familiar with the appliance use, limitations and associated restrictions. Operating instructions must be read and understood by all persons using or installing this appliance.
2. This appliance must be grounded. Connect only to properly grounded outlet.
3. Use this appliance only for its intended purpose as described in the manual. This equipment is intended for use in commercial establishments only.
4. Cleanliness of this appliance and its accessories is essential to good sanitation.
5. DO NOT submerge this appliance in water. This appliance is not jet stream approved. DO NOT direct water jet or steam jet at this appliance, or at any control panel or wiring. DO NOT splash or pour water on, in or over any controls, control panel or wiring. DO NOT use corrosive chemicals or vapors in this appliance.
6. DO NOT store this appliance outdoors. DO NOT use this product near water – for example, near a kitchen sink, in a wet basement, or near a swimming pool, and similar areas.
7. DO NOT operate this appliance if it has a damaged cord or plug, if it is not working properly, or if it has been damaged or dropped. Do not immerse cord or plug in water, keep cord away from heated surfaces, and do not let cord hang over edge of table or counter.
8. DO NOT cover or block any openings on the appliance.
9. Only qualified service personnel should service this appliance.

Safety Precautions During Operation

1. Do not allow contaminated items and/or garbage inside the appliance.
2. The door should remain closed when not working with the GardenChef.
3. Do not remove the growing drawers when the appliance is watering. Refer to instructions for controlling the watering and lighting schedules.
4. Do not sit or stand on the open door or growing drawers. Doing so will damage the drawers and slides & is a tipping hazard.
5. Unplug the power cord from the outlet and disconnect the water supply when the appliance is not in use. Place the cap with storage solution on the pH sensor when it is not in use. It must not be allowed to dry out or it will not function properly.
6. Use genuine OEM parts when servicing and repairing the appliance. Any attempts to repair the GardenChef without an authorized professional can be dangerous, cause damage to the cabinet and void your warranty.
7. Do not place anything on top of the GardenChef.
8. Take care when removing the grow drawers as they are heavy when fully loaded with plants, soil and water. It is advised to remove the flats of plants before removing the drawers.
9. Before moving your GardenChef, make sure there is no water in the reservoir. Water adds weight and may cause level issues if left in the unit. It may also slosh out of the reservoir creating a slip hazard.

CAUTION: Purchase supplies and seeds from reputable suppliers and follow instructions for proper safety and growing. Carter-Hoffmann assumes no liability for conditions resulting from improper growing, maintenance and safety. Follow all safe food handling practices when growing and harvesting.

GROUNDING INSTRUCTIONS

This appliance is equipped with a cord having a grounding wire with a grounding plug which must be plugged into an outlet that is properly installed and grounded. In the event of an electrical short circuit, grounding reduces the risk of electric shock by providing an escape wire for the electric current.

WARNING—Improper use of the grounding can result in a risk of electric shock. Consult a qualified electrician or service agent if the grounding instructions are not completely understood, or if doubt exists as to whether the appliance is properly grounded.



WARNING:
Risk of personal injury

Installation procedures must be performed by a qualified technician with full knowledge of all applicable electrical and plumbing codes. Failure could result in personal injury and property damage.



WARNING:
Tipping hazard

Anchor straps **must** be used to secure unit to a wall. Unit **must** be anchored, using straps along with the anchor points located in the upper corners of the back of the unit to structural supports in the wall behind the unit.



IMPORTANT:
Power cord is 10' long

If necessary, contact a licensed electrician to install an appropriate 15 amp electrical circuit with correct NEMA receptacle. Ensure that the plug is accessible after installation.

DO NOT use an extension cord.



CAUTION:
Electrical Shock Hazard

The ground prong of the power cord is part of a system designed to protect you from electric shock in the event of internal damage.

DO NOT cut off the large round ground prong or twist a blade to fit an existing receptacle.



IMPORTANT:
Not under warranty

Damage to unit due to being connected to the wrong voltage or phase is **NOT** covered by warranty.



IMPORTANT:
FILTERED WATER REQUIRED

Due to varying water quality in different municipalities, make sure that your facility water is filtered of sediment and chemicals before hooking up the fill lines. Sediment from hard and soft water may eventually clog up the pumps and filters.

INSTALLATION AND STARTUP

LOCATION

- Place the cabinet on level ground. Lock the front wheel caster brakes. Adjust the leveling legs so that they are on the floor. If your floor is not level, adjust the legs so that the unit is level. **NOTE: the cabinet must be level in order to function properly.**
- Leave at least 36 inches (914 mm) at the front of the cabinet, leaving enough space to open the doors and pull the drawers out.
- Allow a two to six inch gap between the top of the unit and the ceiling and at least 2" of space at the rear for ventilation.
- Install the anti-tip straps, included with the cabinet. **IMPORTANT: THIS MUST BE DONE BEFORE PROCEEDING WITH INSTALLATION OR OPERATION OF THE CABINET.**

INSTALLATION OF THE ANTI-TIP STRAPS

Before you operate the cabinet it must be installed, using anchors and straps, to prevent tipping.

- 1) Verify that you have these 4 items included with your GardenChef: (2) ¼-20 X ¾" long screw, (2) washers, (2) 8' long straps, (4) mounting brackets. (Fig. 1)
- 2) Using screws, washers, and the mounting plate, mount the bracket to the back of the cabinet as show in Figure 2
- 3) On the wall adjacent to the back of the cabinet, install wall anchors (acquired by other supplier) at equal height for the type of wall being used (i.e. wood, drywall, cement block, poured cement)
- 4) Install the mounting plate on the wall anchors with a screw and washer (acquired by other supplier) matching the wall anchor.
- 5) Thread the loose end of the strap as shown in Figure 3 and then through your wall mounted anchor
- 6) As shown in Figure 4, thread the loose end of the strap through the buckle

Figure 1



Figure 2



Figure 3



Figure 4



Continued on next page

INSTALLATION AND STARTUP



WARNING: Risk of personal injury

Installation procedures must be performed by a qualified technician with full knowledge of all applicable electrical and plumbing codes. Failure could result in personal injury and property damage.



WARNING: Tipping hazard

Anchor straps **must** be used to secure unit to a wall. Unit **must** be anchored, using straps along with the anchor points located in the upper corners of the back of the unit to structural supports in the wall behind the unit.



IMPORTANT: Power cord is 10' long

If necessary, contact a licensed electrician to install an appropriate 15 amp electrical circuit with correct NEMA receptacle. Ensure that the plug is accessible after installation.

DO NOT use an extension cord.



CAUTION: Electrical Shock Hazard

The ground prong of the power cord is part of a system designed to protect you from electric shock in the event of internal damage.

DO NOT cut off the large round ground prong or twist a blade to fit an existing receptacle.



IMPORTANT: Not under warranty

Damage to unit due to being connected to the wrong voltage or phase is **NOT** covered by warranty.



IMPORTANT: FILTERED WATER REQUIRED

Due to varying water quality in different municipalities, make sure that your facility water is filtered of sediment and chemicals before hooking up the fill lines. Sediment from hard and soft water may eventually clog up the pumps and filters.

IT IS VERY IMPORTANT THAT THIS NEXT STEP IS COMPLETED CORRECTLY

- Pull both ends of the strap as show in Figure 5, make sure that the strap does not slide through easily



Figure 5

- Pull the strap tight and tie up the rest of the strap neatly as shown in Figure 6

Figure 6



- Connect city water supply and city drain to the 3/8" NPT female fittings at the back of the unit (Fig. 7). Access to the connections will be at the back of the cabinet. **NOTE: This unit is to be installed with adequate backflow protection to comply with all applicable federal, state and local codes.**
- City water connection **must be less than 10 feet from the cabinet** and **no higher than 6 feet** from the connections. **A minimum of 35 PSI is required to feed the cabinet.**
- Install the lights and diffuser panels (instructions on page 20)
- The 120V electrical outlet should be within 6 feet of the cabinet. Do not use an extension cord. Connect to a properly grounded outlet according the electrical specifications for the cabinet. See page 2 for specifications.



Pipes that have not been used regularly should be cleaned and flushed with running water before connecting the cabinet.



Check the condition of the water inlet hose and drain hose prior to connection. They should not be twisted, crushed, tangled or leaking. Do not use connection hoses that have been previously connected to other appliances.



If the unit is built in to a wall or structure, make sure that it can be easily moved to access to the back and side panels for service and maintenance.

Fig. 7



City fill connection:
3/8" NPT female
fitting

City drain connection:
3/8" NPT female fitting

START-UP

Note: the cabinet must be plugged in and plumbed by a professional technician in accordance with applicable local and state codes. When you plug the unit in, it will turn on and you will see the startup screen (A). The unit runs diagnostics and start-up functions while this screen is visible. You do not need to do anything while the startup screen is showing. The unit will automatically go to the HOME screen following the start up screen. To unlock the screen, press any button and a number pad will appear. Enter "1551" then "✓". Note: when the cabinet sits for long periods of time or it is turned off and then on again, it will automatically revert to locked mode. You will have to use the unlock code any time this happens. Follow these steps to set up your GardenChef for the first time:

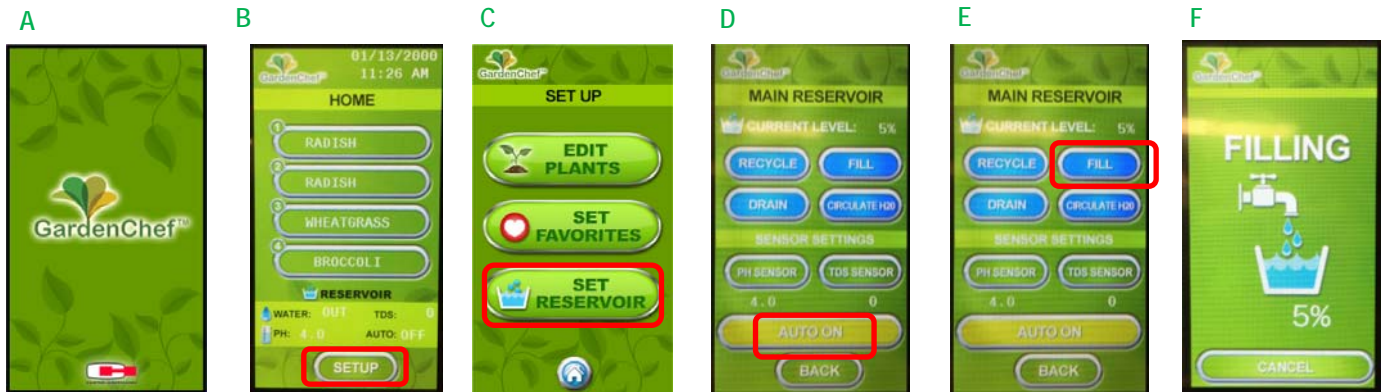

GC11: 1 zone
GC12: 2 zones
GC41: 4 zones (shown)
GC42: 8 zones

FILL THE WATER RESERVOIR USING CITY WATER

Ensure water lines are hooked up (see page 6). Check the reservoir and make sure it is free of dirt and debris before filling.

- 1 Remove the bottom grow drawer(s) to access the water reservoir
- 2 From the home screen (B), press SETUP, SET RESERVOIR (C), AUTO ON (D) to switch to city water mode*
- 3 Press FILL (E) and check to make sure the water is filling into the reservoir. The screen will display FILLING (F).
- 4 Once full, the GardenChef's onboard computer will maintain a constant water level

*For **manual filling**, press AUTO OFF, then fill manually to the top of the float sensor (about 5.5" deep). Water level must be monitored and replenished if it gets low.

SET UP THE pH DOSER (pH Down solution and drill required)

 Note: Auto dosing requires that the irrigation pump be primed first. See page 10 for instructions.

 **CAUTION:** pH Down is acidic. Read all instructions on the bottle for proper handling. Failure to do so may cause bodily harm.

- 1 Remove the lower growing drawer(s) to access the dry box (Fig. 3)
- 2 Place a pH dosing bottle in the dry box. Any clean bottle will do as long as it is not taller than the dry box. Drill a hole into the cap to insert the dosing line. If the cap is the same size as your pH down solution bottle, place the cap from the dosing bottle onto the pH down bottle. If they are not the same size, fill the pH dosing bottle with pH down solution. Place the bottle into the dry box.

- 3 From the home screen (B), press SETUP, SET RESERVOIR (C), then Press PH SENSOR (F), then set AUTO DOSE to ON (G) and then press DONE (G)

The onboard computer will check every hour and will run the dosing pump as needed to maintain the pH level. Default pH is 5.5, but can be changed on the SET RESERVOIR screen. Most plants need a pH level of 5 to 7.

Note: Calibration does not need to be done on initial set-up.

Fig. 1
Access the
water reservoir



Fig. 2 Float
switch/sensor;
left side of
reservoir;
shuts off water
once filled to
proper level



Fig. 3 Dry box
with pH dosing
bottle

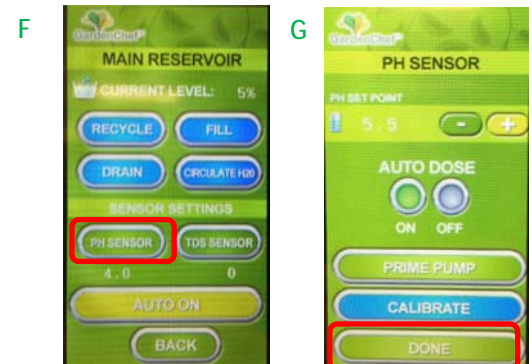

Continued on next page

START UP(continued)

CALIBRATE THE pH SENSOR



In order to function properly, the pH sensor needs to be calibrated.
Supplies needed: #4 pH buffer solution (yellow), #7 pH buffer solution (blue), clean water, 3 cups or containers, clean cloth.

- 1 Remove the bottom growing drawer(s) to access the reservoir (Fig.1)
- 2 Locate the pH sensor probe on the left side of the reservoir (Fig.2)



Fig. 1 Access the water reservoir; the sensor will be on the left side

- 3 Fill one cup of water, one cup of pH buffer #4 (Fig. 3) and one cup of pH buffer #7 (Fig. 4)

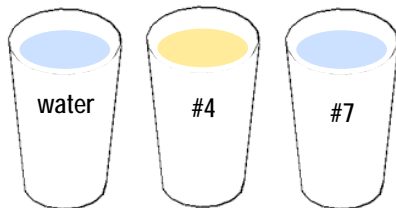

- 4 Remove the cap from the sensor and gently wash the pH probe in the water and dry with a clean cloth.



Fig. 2 Blue PH sensor (shown with cap on)

- 5 Gently swish the probe in the cup containing pH buffer #4. Continue to swish the probe and follow instructions in step 6.



- 6 Enter the pH calibration screen by pressing SETUP (A), SET RESERVOIR (B), PH SENSOR(C), then CALIBRATE (D) and follow the instructions on the screen.

Calibration will take about three minutes to complete.

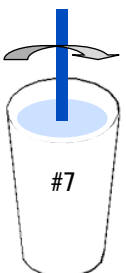

Fig. 3
PH buffer #4



Fig. 4
PH buffer #7

- 7 Wash the pH sensor in the cup of water and dry with a clean cloth. Repeat steps 5 and 6 for pH buffer #7 solution



- 8 Press DONE when calibration is complete



IMPORTANT: Safely store the pH sensor cap and use it to stop the sensor from drying out when the water reservoir is empty. Do not let the pH sensor dry out. Fill cap with pH #4 calibration solution before placing it on probe to store the sensor. Failure to follow this procedure will ruin the sensor and void the warranty.

Continued on next page

START-UP (continued)

CALIBRATE THE TDS (TOTAL DISSOLVED SOLIDS) SENSOR (EC 1000 PPM solution required)



In order to function properly, the TDS sensor needs to be calibrated. Supplies needed: EC 1000 PPM solution, clean water, 2 cups or containers, clean cloth.

- 1 Remove the lower grow drawer(s) to access the reservoir (Fig.1)
- 2 Locate the TDS sensor probe on the left side of the reservoir (Fig.2)



Fig. 1
Access the water reservoir

- 3 Fill one cup with water and one cup with EC 1000 PPM solution

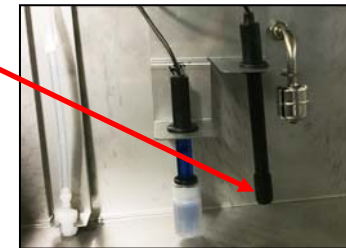
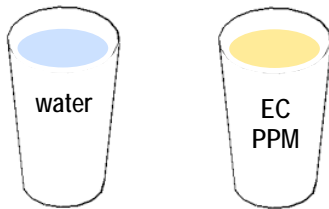
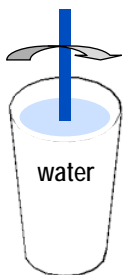
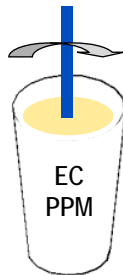

Fig. 2
TDS sensor (black)

- 4 Gently wash the TDS probe in the cup of water and dry with the cloth.



- 5 Gently swish the probe in EC PPM solution and, while swishing the probe, enter the calibration screen.



- 6 To enter the TDS calibration screen press SETUP (A), SET RESERVOIR (B), TDS SENSOR (C), then CALIBRATE (D) and follow the instructions on the screen. Continue to swish the probe in the solution for three minutes.

Calibration will take about three minutes to complete.

Press FINISH (E) when complete.

START-UP (continued)

PRIMING THE IRRIGATION PUMP

- Access the reservoir (Fig. 1)
 - 1 If present, remove any grow trays from the bottom drawer(s)
 - 2 Slide out drawer(s) to access the reservoir
- Fill reservoir
 - 1 Make sure the unit has been connected to the water and power according to local codes
 - 2 From the HOME screen, press SET UP, SET RESERVOIR, AUTO ON, FILL
 - 3 Wait until the reservoir is full with water. Monitor the filling of the reservoir to assure proper fill.

Fig. 1



Fig. 2



Irrigation pump

Circulation pump



Fig. 3
Priming valve
in OPEN
position

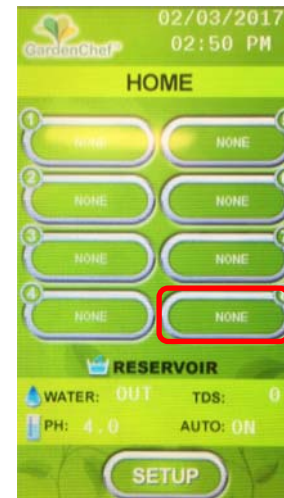

Fig. 4
Priming valve
in CLOSED
position

- Priming
 - 1 Access the priming valve near the circulation pump. It should be in the OPEN position and water should be flowing downwards into the reservoir
 - 2 From the HOME screen, select ZONE 8 if you have a GC42, ZONE 4 if you have a GC41, ZONE 2 if you have a GC12 or ZONE 1 if you have a GC11 (A). In each case this will be the growing zone that is directly above the pumps. Press WATER NOW (B).
 - 3 Open (1/4 clockwise turn) and wait for steady stream of water to come out of the priming valve (Fig 3); once you have a steady stream of water, close the valve (Fig 4).
 - 4 Water should now be flowing steadily from the irrigation nozzle in the zone selected in step 2 (Fig. 5). Press WATER NOW (B) to turn off the watering cycle for that zone. Leave the priming valve in the CLOSED position.

Your pump is now primed.

Fig. 5 Zone irrigation nozzle



SETTING UP YOUR GROWING CYCLES

Note: the cabinet must be plugged in and plumbed by a professional technician. Follow these steps to set up your GardenChef for the first time. Your GardenChef may have 8, 4, 2 or 1 growing zones and the home screen will show the appropriate number of zones for the model that you have.

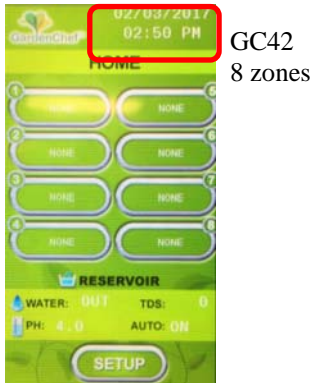

SET UP THE DATE AND TIME

On the home screen, press the date/time in the upper right hand corner. This will take you to the TIME AND DATE SCREEN.

Using the UP and DOWN arrows, set the date and time.

Press DONE when you are finished.

The date and time are now set so you can accurately program and monitor the growing cycles.



SET UP YOUR SEED MENU

The cabinet comes with pre-set cycles for growing a variety of plants. It can also be programmed to set up the zones for special seeds or changing the lighting and watering cycles for each plant. On the HOME screen, select the zone for the seed you would like to program: GC42 (8 zones), GC41 (4 zones), GC12 (2 zones) and GC11 (1 zone). On the zone screen, press CHANGE SEED and you will be taken to the FAVORITES screen.

An alphabetical list of preprogrammed seeds will appear. Scroll through the list to find the seed you want, using the NEXT button to get to each screen (there are 5 screens, with a few spaces left empty at the end for custom programming of new items). NONE is the first item and can be used for designating shelves that might not be needed during a particular growing cycle. Press SELECT to choose your seed. Repeat for each of the zones you wish to use.

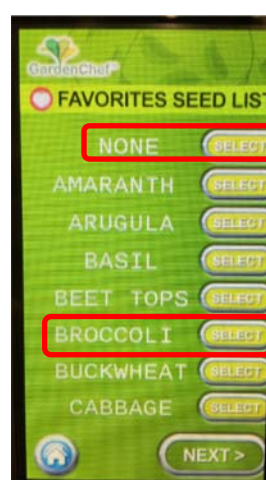

PROGRAMMING CYCLES

You can change the lighting and watering cycles for specific seeds, or new seeds that are not in the default programming cycles.

EDIT CYCLES

From the HOME screen, press SET UP. On the SET UP SCREEN, press EDIT PLANTS.

Select a plant and then the cycle will appear for that zone. You will see buttons for temperature, water and lights.

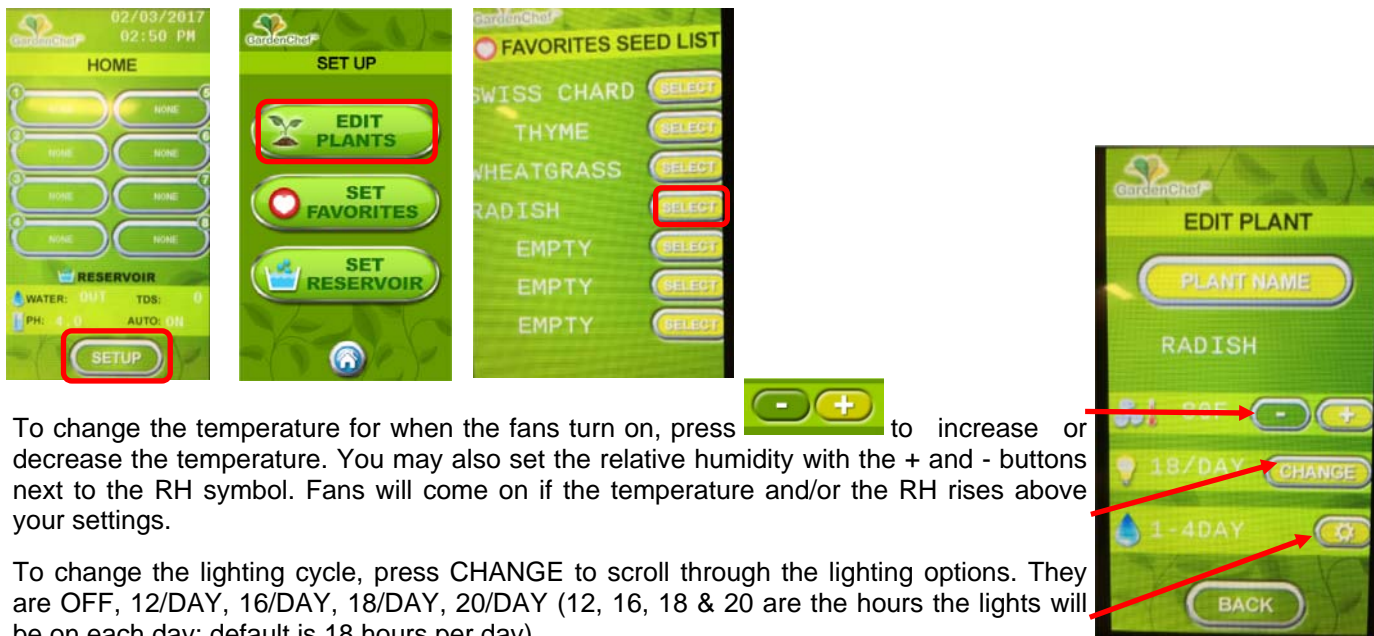

To change the temperature for when the fans turn on, press  to increase or decrease the temperature. You may also set the relative humidity with the + and - buttons next to the RH symbol. Fans will come on if the temperature and/or the RH rises above your settings.

To change the lighting cycle, press CHANGE to scroll through the lighting options. They are OFF, 12/DAY, 16/DAY, 18/DAY, 20/DAY (12, 16, 18 & 20 are the hours the lights will be on each day; default is 18 hours per day)

To change the watering cycle, press  and use the arrows to select a watering cycle. The choices for watering cycle are:

- OFF: (no watering cycle)
- 1X DAY: (once each day)
- 2X DAY: (twice each day)
- 1-2 DAY: (once every other day)
- 1-3 DAY: (once every 3 days)
- 1-4 DAY: once every 4 days (default for most cycles; soil germination)
- 1-5 DAY: once every 5 days

Note: once or twice a day watering cycles are normally used for growing hydroponically, depending on your hydroponic growing media, i.e. perlite, mats, etc.)

You may also change the duration of the watering cycle anywhere between 1 and 10 minutes. Press the + and - buttons to increase or decrease the minutes. The default is 5 minutes.

Press BACK when you are finished. You can select another plant to change or press  to return to the HOME screen.

SET YOUR FAVORITE PLANTS

You can reduce the size of your plant selection list from the home screen to just your favorites so you don't have to scroll through the entire list of saved plants to find your favorites and at the same time keep the programming for all of your plants, when you need them.

From the HOME screen, press SETUP, then from the SETUP screen, select SET FAVORITES. You will see the entire list of plants you have stored in the controller. To set your favorites, press the screen to the right of the plant names you would like to make your favorites. A little heart will appear, indicating that the plant is now a favorite. To de-select plants from the list, press the heart button until it disappears. You can scroll through the entire list using the NEXT button. To save your favorites, press the HOME button



PROGRAMMING CYCLES

TO START A GROWING CYCLE

On the HOME screen, select a seed for the zone you have just planted (Fig. 1), and you will enter the screen with the settings for that zone (Fig. 2).

Press the START CYCLE button and a cycle will begin. Then press the HOME button 

Repeat for each zone that you have planted. Different zones can be started on different days, so not all have to be active at the same time and you can stagger growing cycles.

The circulation pump will operate at the top of every hour to circulate the water and mix nutrients. In the GC42 and GC12, it will run for 2 minutes. In the GC41 and GC11 it will run for one minute.

Fig. 1



Fig. 2



OTHER FUNCTIONS IN THE ZONE SCREEN

If you plant something different or move trays from one zone to another, you can change to the cycle for a different seed by pressing CHANGE SEED. This will take you to your FAVORITES menu and you can select from your favorites.

If you would like to do an unscheduled watering, you can press the WATER NOW button and start a watering cycle. Monitor the watering cycle and press the WATER NOW button again when you would like the watering cycle to stop.

To cancel a growing cycle, go to the ZONE screen for the particular cycle you want the cancel. Press START CYCLE. This will cancel the existing cycle and automatically start a new cycle. You will see the day counter on the top right of the screen revert to DAY 00.

OTHER FUNCTIONS IN THE MAIN RESERVOIR SCREEN

From this screen, you can automatically drain and fill your cabinet using the **DRAIN** and **FILL** buttons. In addition to the regular DRAIN and FILL functions, there is also a **RECYCLE** function. This function can be used when all you want to do is exchange old water for new water in the cabinet.



CAUTION:

The cabinet **MUST** be hooked up to city water connection AND drain for doing any of these functions. It is equipped with a last chance option to not do an automatic drain. This is built in to make sure you are hooked up to municipal water and drain before you perform any a drain or recycle. The screen will ask if you are sure before beginning the draining process. A draining screen will appear for you to monitor the progress on the draining cycle.

The cabinet will automatically circulate the water in the reservoir every hour. However, the **CIRCULATE H2O** button can be used when adding nutrients. It will activate the circulation pump to stir and distribute the water in the reservoir after adding nutrients. It will run for two minutes in the GC42 and GC12 and one minute in the GC41 and CG11.

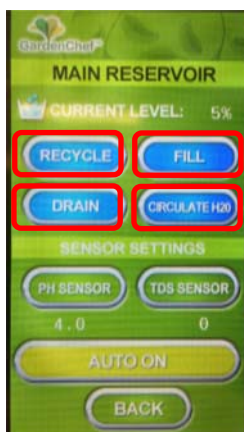

PLANTING AND GROWING

Planting and growing is easy in the GardenChef. Follow these simple instructions. See the growing guide for specific plants on the next page.

- Please refer to the Growing Guide and Growing Tips for successful growing and harvesting of specific plants.
- See Sanitation and Safety Guidelines on page 21 for safe growing and harvesting.

Materials Needed (planting using soil)*:

Potting Soil (sterile)	Screen/Mat	1—20 gal plastic tub (unsifted soil); smaller tub (sifted soil)
Seeds	Shaker	Propagation domes
10" x 20" planting trays**	Sifter	Kitchen scale (for weighing seeds)
Misting bottle		

*If you are planting hydroponically, you will need a soil-free medium such as perlite or soil free mat instead of soil

**You may also use 10" x 10" planting trays; 2 will fit in the same space as a 10" x 20"

- 1 Place soil into the larger tub
- 2 Using the sifter, sift the soil into the smaller tub; you will need 1 to 1.5 cups of sifted soil for each tray to be planted.
- 3 Add more soil to the large tub, enough to fill the trays 1/2 to 1/4 full. Moisten the soil, enough to make it damp and crumbly, but NOT wet and muddy. Mix the soil when adding the water; DO NOT ADD WATER TO THE TUB OF SIFTED SOIL

4 Place mats into the trays



5 Put the damp, unsifted soil into the tray(s), fill each tray 1/2 to 3/4 full and level.



6 Weigh/measure seeds and spread evenly with shaker, spoon or cup. (see Growing Guide, p. 15).



Sprinkle just enough sifted soil over the seeds to cover them. About 1 to 1.5 cups.



If the sifted soil is dry, you can moisten it with a spray bottle. Do not soak.

7 Place the propagation dome on the tray. Make sure the vents are CLOSED



8 Place the trays into the growing drawers in your GardenChef.



9 Program your watering and lighting cycles according to the growing guide.

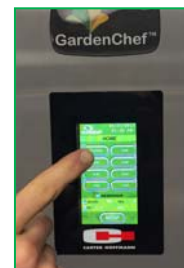

10 Leave the domes on until the seeds sprout.

11 Remove the domes for the rest of the growing cycle.



12 HARVEST!

Harvest all greens



Or thin out greens and use as they grow. This method can be used to extend the growing cycle, especially for growing shoots and herbs.

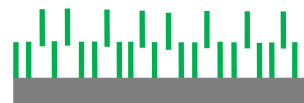

GROWING GUIDE

Seed	Sowing Amount / 10"x20" tray		Germination Days (domes on)	Days to Harvest	Watering Schedule ¹ (potting soil)	Flavor Profile
	Grams	Ounces				
Amaranth	17	0.6	2-3 days	7 - 16 days	1 every 4 days	Beet, grassy
Aniseed	28	1	2 days	7 - 8 days	1 every 4 days	Licorice
Arugula	28	1	3 days	7-16 days	1 every 4 days	Nutty, peppery
Basil (Sweet, Genovese, Thai)	20	0.7	2-3 days	10-21 days	1 every 5 days	Slightly sweet, herby
Beets, Bulls Blood	28	1	3-6 days	10-20 days	1 every 4 days	Beet, earthy
Broccoli	28	1	1-3 days	7-15 days	1 every 4 days	Mild broccoli, slightly bitter
Buckwheat	113	4	2-4 days	7-14 days	1 every 3 days	Lettuce, tangy
Cabbage, Red	28	1	2-5 days	10-15 days	1 every 4 days	Mild, cabbage
Carrot Tops	37	1.3	2-4 days	8-14 days	1 every 4 days	Mild, earthy
Celery	28	1	5-7 days	13-16 days	1 every 4 days	Mild celery taste
Chervil	28	1	4-6 days	16-22 days	1 every 4 days	Mild parsley and licorice
Chia	28	1	2-5 days	10-12 days	1 every 4 days	Slightly bitter, minty, tangy
Chives	28	1	6-9 days	14-24 days	1 every 4 days	Mild garlic, onion
Cilantro (Coriander)	37	1.3	4-10 days	14-20 days	1 every 4 days	Strong celery, cilantro
Cress (Cressida/Pepper)	28	1	3-4 days	8-14 days	1 every 4 days	Peppery
Dill	28	1	3-7 days	12-15 days	1 every 4 days	Dill
Fenugreek	17	0.6	2-5 days	10-14 days	1 every 4 days	Mildly spicy, nutty, pungent, bitter
Flax	28	1	2-4 days	8-12 days	1 every 4 days	Mildly spicy, nutty
Kale, Red Russian	35	1.25	2-4 days	10-15 days	1 every 4 days	Subtle broccoli flavor
Kholrabi	28	1	2-4 days	7-14 days	1 every 4 days	Mild, sweet
Komatsuna	28	1	2-4 days	10-14 days	1 every 4 days	Cabbage, mustard, mildly sweet
Lemon Balm	34	1.2	3-5 days	14+ days	1 every 4 days	Lemony
Lemongrass	14	0.5	2-3 days	14+ days	1 every 4 days	Strong lemon, sweet
Lettuce (various)	28	1	2-4 days	10-16 days	1 every 4 days	Lettuce, depends on variety
Marjoram	14	0.5	2-4 days	10-14 days	1 every 4 days	Similar to oregano but milder and sweeter
Marigold	28	1	2-4 days	8-18 days	1 every 4 days	Citrus, mildly spicy
Mint	14	0.5	2-3 days	10-14 days	1 every 4 days	Mint
Mizuna (Japanese Mustard)	28	1	2-4 days	8-14 days	1 every 4 days	Mild pepper
Mustard	28	1	3-4 days	7-15 days	1 every 4 days	Slightly spicy, sweet mustard
Nasturtium, Dwarf	56	2	3-6 days	10-21 days	1 every 4 days	Pepper, mustard
Oregano	28	1	5-7 days	16-22 days	1 every 5 days	Pungent, oregano
Pak Choi	28	1	1-3 days	8-12 days	1 every 4 days	Mildly sweet, earthy
Parsley	28	1	5-7 days	18-30 days	1 every 4 days	Mild parsley
Pea Shoots	142	5	2-5 days	8-15 days	1 every 4 days	Sweet pea, nutty
Popcorn Shoots	28	1	2-3 days	6-8 days	1 every 4 days	Sweet corn
Purslane, Red Gruner	28	1	3-5 days	10-14 days	1 every 4 days	Tangy, spinach
Radish	42	1.5	1-3 days	8-10 days	1 every 4 days	Strong spicy, peppery
Sage	28	1	7-10 days	18-25 days	1 every 4 days	Strong sage

Table continues on page 16

*Figures in this table are estimates. Germination & harvest times may vary depending on seed variety, quality & growing conditions. Consult instructions from your seed supplier.

¹For soil-free (hydroponic) growing, watering cycle frequency and duration are dependent on type of media that is used. See Growing Tips on page 16.

GROWING GUIDE

Seed	Sowing Amount / 10"x20" tray		Germination Days (domes on)	Days to Harvest	Watering Schedule ¹ (potting soil)	Flavor Profile
	Grams	Ounces				
Shiso	28	1	3-5 days	12-21 days	1 every 4 days	Licorice
Sorrell, Ruby-Veined	28	1	3-7 days	12-20 days	1 every 4 days	Tangy, lemon, mildly sour
Sunflower	170-226	6-8	2-3 days	8-12 days	1 every 4 days	Nutty
Swiss Chard	56	2	2-5 days	8-12 days	1 every 4 days	Sweet, earthy
Tangerine Gem (marigold)	56	2	7-14 days	20-30 days	1 every 4 days	Citrus, tangerine, mild pepper
Tatsoi	28	1	2-4 days	8-12 days	1 every 4 days	Mild mustard
Thyme (various)	17	0.6	5-8 days	25-35 days	1 every 5 days	Thyme, some have lemon, cinnamon tones
Watercress	17	0.6	3-8 days	10-12 days	1 every 3 days	Spicy, peppery
Wheatgrass	28-56	1 to 2	2-3 days	7-12 days	1 every 4 days	Mild grassy, slightly bitter

*Figures in this table are estimates. Germination & harvest times may vary depending on seed variety, quality & growing conditions. Consult instructions from your seed supplier.

¹For soil-free (hydroponic) growing, watering cycle frequency and duration are dependent on type of media that is used. See Growing Tips below.

GROWING TIPS

Sowing Your Seeds

The amounts in the table are estimates. A good rule of thumb is a density of 1/8" to 1/4" spacing in the tray. Consult the directions from your seed supplier. As you use your GardenChef®, keep track of germination and density of growing plants. If they seem a bit sparse, add a little more seed to your trays in the next growing cycle. Conversely, if they seem too thick, dial it back. There are numerous resources on the internet that can be helpful to develop your farmer instincts. In addition to planting tips, you can find information on the pros and cons of various types of growing media.

Purchase Seeds from Reputable Suppliers

There are many suppliers online. Make sure they are reputable and follow safe practices for producing seed.

Growing in Potting Soil

The Growing Chart is a good starting point for growing in soil. We recommend beginners start with growing in soil as it is easier and plants take naturally to growing in soil! Use commercially produced potting soil. Do not use garden soil or dirt from outdoors.

Hydroponic Growing Media

Your GardenChef can be used for growing hydroponically. Some hydroponic media, such as perlite, drain and dry quickly. Others, such as coconut coir, are like a sponge and absorb a large amount of water. Depending on the media, you will have to adjust the frequency and duration of your watering cycles.

About Nutrients

Potting Soil: Enough nutrients are present in potting soil for about 2-3 weeks, which is adequate for most growing cycles. If you plan to extend the growing cycle, you will need to add nutrients to the reservoir.

Hydroponics: Hydroponic media is sterile, meaning there are no nutrients in it for plants. You will have to add nutrients to the reservoir throughout the growing cycle to feed your plants. Follow the instructions on the nutrient bottle.

pH Levels

Most plants are happy at a pH between 5 and 7, which is slightly acidic (7 being neutral). Most tap water is neutral. If pH gets much over 7, it will affect the health and vigor of your plants. As growing cycles progress, pH tends to rise. The cabinet is equipped to monitor and change the pH as necessary, so make sure you set up pH dosing with a pH down solution. You can get pH down at your local garden supply center. **DO NOT USE POOL CHEMICALS.**

Monitor Your Plants

The best way to learn is to check your plants daily and observe their growth and health. You can nip potential problems in the bud, learn how your plants grow and when to harvest for your particular needs.

Regular Cleaning

A healthy environment makes healthy plants. Clean your cabinet and growing supplies regularly to reduce the chance of contamination. See cleaning instructions on page 17-19 and sanitation guidelines on page 22.

Disease Prevention

In addition to regular cleaning, monitor your watering cycles, temperature and humidity levels. Overwatering, or too much humidity can cause mold to grow. Adjust them as needed.

CLEANING AND MAINTENANCE

CLEANING THE RESERVOIR & IRRIGATION SYSTEM

1. **Make sure cabinet is connected to city drain and water.** If you are not hooked up to a drain and city water you will need to manually drain and fill the cabinet; if this is the case, connect the drain fitting to a hose that runs to a drain or sink. Do not activate the DRAIN function until you have a place to drain the water with a hose to a sink or drain, observing all municipal codes. Used water from the GardenChef is not potable.
2. Remove the bottom drawer(s)
3. From the HOME screen, press SETUP
4. In the SETUP screen, press SET RESERVOIR
5. Press DRAIN. The next screen that appears will ask if you are sure. Double check that the cabinet is hooked up to a drain. Otherwise it will drain onto your floor! If you are not sure, press no and double check. If you are sure, press YES.
6. The cabinet will start to drain the reservoir. This may take up to 30 minutes. Once the reservoir has been drained, wipe off any dirt with a clean rag.
7. Add your preferred cleaning solution (i.e. hydrogen peroxide mixture) into the reservoir. Follow the guidelines on the label of the agent. The capacity of each model is: GC42 & GC12: 22 gallons; GC41: 11 gallons. H₂O₂ concentration should be 5 tsp per one gallon of water.
8. From the HOME screen, press SET RESERVOIR, then FILL. Filling should take approximately 30 minutes.
9. When the reservoir has refilled, from the HOME screen press, ZONE 1 and then WATER NOW so that the cleaning solution flows through the GardenChef's piping system to ZONE 1
10. Repeat step 10 for each zone
11. Once the zones and reservoir are cleaned, from the HOME screen, press SETUP, SET RESERVOIR, then RECYCLE. This will drain the reservoir of the cleaning solution and then refill it with fresh water for your next growing cycle.

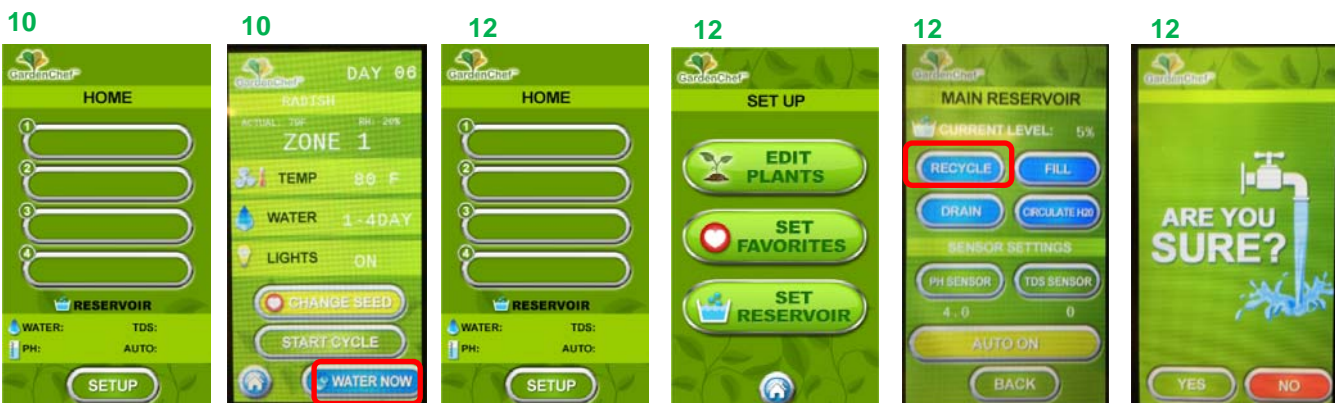
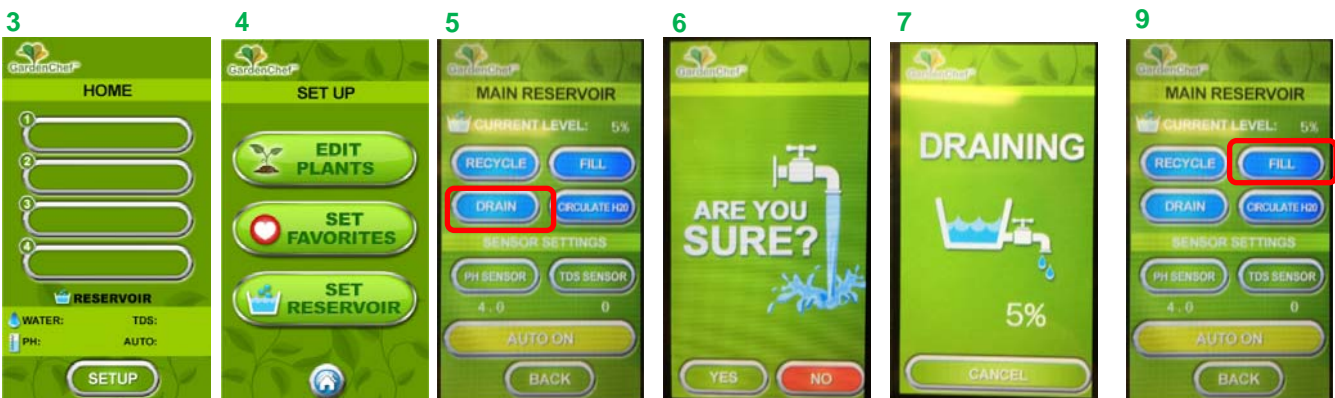

CLEANING AND MAINTENANCE (continued)

CLEANING THE GROWING DRAWERS Clean your growing drawers between each harvest. Monitor the interior of the cabinet, including the reservoir, during the growing cycle and clean at the first sign of mold or build-up of organic matter.



Do not use any chemically damaging or toxic cleaning products such as bleach or ammonia. Do not use stainless steel cleaner on the interior of the cabinet. Chemical cleaning products can damage the stainless steel, and are toxic plants. Use a diluted hydrogen peroxide solution to clean the reservoir and water lines (use 5 teaspoons/gallon of water for a 30% solution). Read all warning labels on the hydrogen peroxide or other cleaning products.

Keep your growing environment clean.

Clean the reservoir, reservoir filter and grow drawers every month.

GENERAL STAINLESS STEEL CLEANING

Clean the exterior of your cabinet when fingerprints and large amounts of dust appear on the outer surfaces. Using Stainless Steel cleaner from your local hardware store, spray on and wipe down with a cloth going with the grain (As seen in the pictures). **DO NOT USE STAINLESS STEEL CLEANER IN THE RESERVOIR OR IN THE DRAWERS THEMSELVES.** Stainless steel cleaner is to only be used on the outer surfaces of your cabinet!

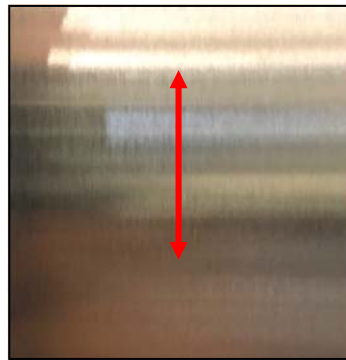

CLEANING CAUTIONS

When you wipe down the reservoir, take care to not hit the pumps or sensors, or misalign the irrigation tubing.

Draining the reservoir sends water down and out from the drain hose. Water from the GardenChef is not for drinking as biological residues may be present and could be harmful.

Do not use steel wool pads to clean the reservoir as they will damage the steel and its rust-resistant finish.



Do not use detergents or solutions that contain chlorides, ammonias, alkalis or abrasive cleaners. Use only environmentally safe, non-toxic solutions in the manufacturers' recommended concentration. Non-chlorine bleach from an environmentally-friendly company may be used in accordance with the guidelines on the packaging.

DAMAGE TO STAINLESS STEEL IS PERMANENT, COSTLY TO REPAIR, AND IS NOT COVERED BY THE WARRANTY

PERIODIC MAINTENANCE PROCEDURE AND TIPS

INSIDE THE RESERVOIR

A. DRAIN, CLEAN AND FLUSH RESERVOIR (Monthly)

SEE INSTRUCTIONS ON PAGE 17

B. CHANGE FILTER (30-45 days*—more often in areas with hard water; filter is washable for extended use)

1. Locate the filter (large blue or white canister in the reservoir) and unscrew the canister clockwise. A wrench for the canister was included with your cabinet.
2. Remove and discard excess water.
3. Clean or change the filter and screw the canister back into place.

You may need to re-prime the pump after this procedure. See instructions on page 10.

** The type of media you use for growing will affect the frequency you need to change the filter. Once you get through a few growing cycles, you will be able to determine how often it should be changed. Weak water flow to the trays during a watering cycle means the filter may need to be changed.*

C. CHECK AND CLEAN FILTER CAP (Monthly)

1. Remove the small white cap at the bottom of the circulation pump (the pump is the smaller blue cylinder).
2. Rinse the cap.
3. Place the cap back onto the pump

** If the water flow to your growing drawers is inadequate during a watering cycle, check the filter cap to see if it needs to be cleaned.*

D. CHECK WATER AERATOR (Monthly)

1. Locate the aerator (black pump attached with suction cups to the right side wall of the reservoir)
2. Check the outflow nozzle to ensure it is clear of debris.
3. Check the water intake tube & filter at the end to ensure it is clear of debris. To do this, remove the cap from the bottom of the pump, check the filter and wash to remove any debris that may have accumulated. Place it back in the cap and put the cap pack onto the pump.



Filter housing

Water circulation pump; white filter cap at bottom

Aerator

INSIDE THE GROWING AREA

A. CLEAN DRAWERS (Monthly)

1. Remove a drawer from the GardenChef and bring to the sink.
2. Wash with a clean cloth in hot soapy water or wipe down with hydrogen peroxide solution; make sure the drain holes are cleared of any debris.
3. Rinse the drawer with clean water
4. Dry with clean cloth
5. Place back in the cabinet
6. Repeat procedure for each drawer

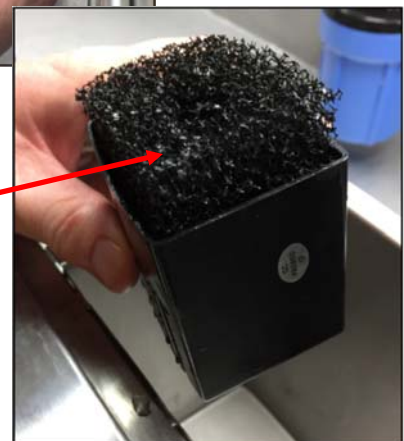

REPLACING THE LIGHTS

Occasionally you may need to replace a light bulb. It is a simple process, similar to changing the bulb on a fish tank hood. For part number, see the list on page 26.

- Remove the diffuser shield by pushing it up with both hands, then pushing it back far enough for the front to drop down, and then pull out
- Grab each end of the bulb (metal ends of tube), rotate clockwise until you can pull the bulb out.
- Insert the ends of the new bulb into the black ends of the ballast, then turn counter-clockwise until the bulb snaps into place.
- Replace the shield by lifting it up and back over the notch in the back of the cabinet, push up the front until it clears the front of the diffuser frame, pull forward and drop into place.

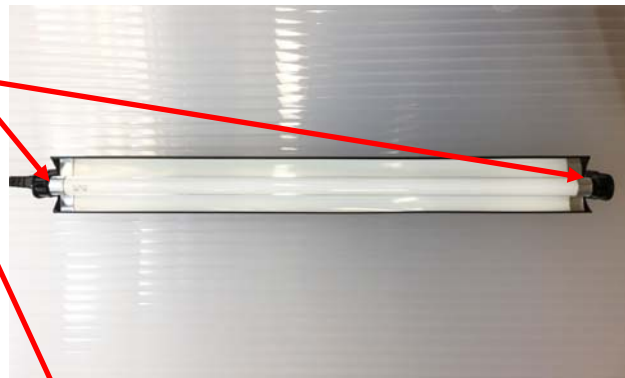
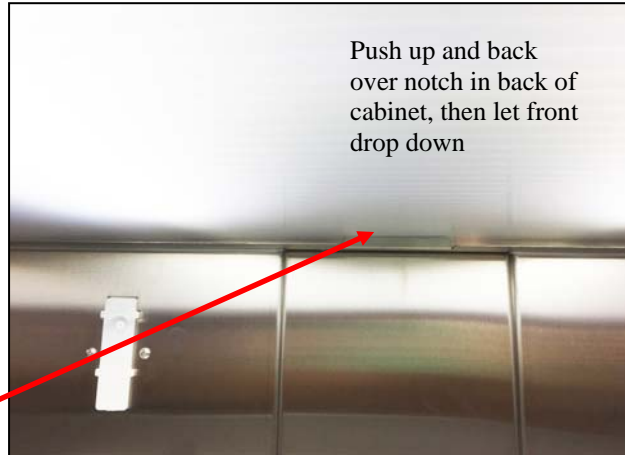

NOTE: T5 growing lights running at the default time of 18 hours per day is considered high use and the efficiency of the bulbs will reduce approximately 10% after 20,000 hours. Bulbs should be replaced every 18-24 months to ensure best performance.

SANITATION AND FOOD SAFETY RECOMMENDATIONS

For your health and safety, please read the information below.

Microgreens are baby plants. They have intense concentrated flavor and more nutrients than full grown plants. They are not sprouts and are safer to grow than sprouts.

Starting with Seeds

Make sure that all seeds you buy have been tested and grown as a food crop and are free from contamination. Do not use seeds from crops that have been fertilized with animal waste. Reputable seed suppliers test all lots of seed for contamination.

Make sure that each seed package is labeled with the name of the seed producer or distributor, the lot number and the country of origin.

Keep records of all seed lots in case of recall.

Sanitation

Use clean seed and growing media from reputable suppliers. Do not use garden soil or dirt from outside.

Regularly clean and sanitize all growing drawers, cabinet and reservoir. Monitor the growing zones daily and clean at the first sign of mold or contamination. Adjust your watering cycles, humidity and temperature so that the fans operate regularly. Clean the cabinet between growing cycles.

Don't let greens or seeds come into contact with contaminated surfaces, manure or other contaminated organic material.

Your growing space, hands and equipment must be kept clean at all times for handling microgreens. We recommend use of food handling gloves during planting and harvesting.

Use clean, potable water in the reservoir.

Clean Seed

You may choose to clean and sanitize your seed prior to growing. It is not necessary with microgreens and reputable suppliers test their seed for contamination. But, if you want to take extra precautions, use this method:

Add 5 ounces of 5% hydrogen peroxide and one ounce distilled vinegar to one quart of room temperature water. Pour the solution over the seed and let stand for 5 minutes, making sure that all of the seed is in contact with the solution. Drain and rinse the seeds in clean water several times to make sure the solution has been removed. Plant as usual.

Growing Conditions

Microgreens are not sprouts and are not grown in the same manner. Commercial sprouts are generally grown in large tanks of water. If one seed is contaminated, it will contaminate all of the sprouts in the tank.

Microgreens are not grown in this way. We recommend growing them in sterile soil or other sterile media which acts as a filter to remove contamination.

Harvesting

Microgreens are newly germinated, small plants and are usually harvested at the stage where the first true leaves appear. They should be harvested with clean hands, or using food handling gloves, clipped at least 2" away from the root system and soil, using clean disinfected scissors. Make sure your harvesting space and containers are clean. Roots or clinging soil, should be removed and your micros should be cleaned thoroughly before consumption.

Refrigerate cut microgreens. Treat them and any foods containing them as food. Note: basil is sensitive to the cold and should not be refrigerated. Use immediately or place in a clean container at room temperature and use within a day.

FREQUENTLY ASKED QUESTIONS & TROUBLESHOOTING

How much soil should I put in my trays?

You should fill each tray 1/2 to 3/4 full with sterile potting soil. Make sure the soil is well moistened, but not overly muddy or soupy. See Resources page 24 for some brands we have found to be high quality soils. For seeds with a shorter life cycle like pea shoots, radishes, wheatgrass (1-2 weeks), 1/2 full is adequate. For seeds with longer life cycles such as basil, oregano, arugula, etc., fill trays 2/3 to 3/4 full.

Why should the seeds be covered with soil at the beginning?

Most seeds like a little darkness while they emerge from their shells. For the best results, sprinkle them with a fine layer of sifted soil, just enough to cover the seeds. Usually 1 to 1-1/2 cups of sifted soil works. The sifted soil spreads easily and provides a nice blanket over the seeds for germination so that more seeds sprout and at the same rate.

I ran out of mats and I need to plant now. Is there anything I can do?

In a pinch, place a thick paper towel in the growing flat, and then add the potting soil. The paper towel will keep most dirt and debris from flowing into the reservoir, while allowing the tray to drain. Two paper towels fit nicely into a 10" x 20" garden flat. They cannot be used for hydroponic growing, as there is not enough thickness or weight for the roots to grab.

When should I use nutrients?

If you are growing in potting soil, nutrients are not necessary for the first 2-3 weeks—usually the duration of a single growing cycle. Beyond that, the soil will get depleted and you will need to add nutrients. If growing hydroponically, you will need to add nutrients from the beginning, since hydroponic media are sterile and contain no nutrients. The cabinet will display total dissolved solids (TDS) of the water in the reservoir on the home screen. Note the TDS when you first fill the reservoir and try to maintain a TDS of 100-250 above that number throughout the growing cycle. As nutrients are added, TDS tends to rise. Too many total dissolved solids will affect growth and health of the micros. Add 2-3 ounces of nutrients at a time, wait 15 minutes for the TDS to adjust. If TDS gets 250 points above the starting number, empty the reservoir and replace with fresh water. Add nutrients to the fresh water.

Is the GardenChef pre-programmed?

Yes, the GardenChef is pre-programmed for many seeds with a default for soil growing. There are a few empty positions open in the menu for adding more seeds and you can erase and replace items in the seed menu. You can also designate your favorite seeds for frequently used cycles. All of the seed programs are adjustable for light and watering schedules.

How often should maintenance be done?

The cabinet requires frequent monitoring and care. It should be inspected thoroughly and cleaned at least once a month. The filter needs to be changed regularly. Maintenance may vary with your usage, depending on the number and types of plants, nutrients, TDS build-up and growing medium (soil vs. hydroponic). Please refer to maintenance and cleaning procedures in this manual.

Does the water reservoir keep itself filled?

Yes. If your GardenChef has been plumbed and hooked up to municipal water supply, then it is pre-programmed to add water and top off as needed. You can also drain and fill the reservoir using the recycle feature in the program.

What do I do if the reservoir won't fill or recycle?

Check to ensure that the connection on your city water and drain is open and free of blockage. Check for kinks in the tubing. The pump may need to be primed. See instructions in this manual for priming the pump.

What if there is no water flowing to a zone?

Make sure not more than two zones are being watered at a time. Only two zones can be watered at one time, so watering schedules for each zone will be staggered an hour apart, if they are programmed to water at the same time. Check the programmed schedule to ensure it is not programmed to be OFF. If still no watering, access the reservoir and insure that the pump is on and primed.

What if there is a weak/no water supply to the drawers during a watering cycle?

It's likely that the screen over the filter is clogged with debris and needs to be cleaned or the filter needs to be replaced. See maintenance and cleaning instructions on page 19.

What if the drawers are not draining properly?

Check the drain holes at the back of the drawers and clear them if they are blocked.

MICROGREEN PROBLEMS

WHITE MOLD



Identification	Remedy
<p>White mold looks like a spider web crawling across the surface of the growing media. It starts out in one area in a small, wispy ball and then expands quickly over the growing media.</p> <p>Note: take a close look. The root systems of some microgreens are fine filaments and resemble mold. Learn to recognize the difference.</p>	<ul style="list-style-type: none"> • Make sure your trays are CLEAN before you plant • Decrease the humidity by increasing air circulation • Decrease the seed density of your future plantings, especially for mucilaginous seeds • Try using some grapefruit seed extract mixed with water as an organic solution

SLOW GERMINATION



Identification	Remedy
<p>Most microgreen seeds germinate in 2-4 days, but some may take a bit longer. If you're seeing germination times that are longer than what is outlined in the table on page 15-16, something is wrong.</p>	<ul style="list-style-type: none"> • Increase moisture in the tray by misting or running an unscheduled watering cycle • Do a germination test on a paper towel to see if the seed is bad. Place a paper towel in a growing tray, moisten it by misting with a mister and sprinkle the seeds on top. Cover with a propagation dome and see if they sprout.

CLUMPY MICROGREENS



Identification	Remedy
<p>When you're spreading your seed out in trays, it can be difficult to get an even spread. If you plant too densely, they will clump together, especially if they're mucilaginous. When they sprout, a few of the seedlings will push the rest of them up into the air, suspending the roots and possibly bringing dirt along with them. It makes harvesting difficult.</p>	<ul style="list-style-type: none"> • Decrease total seed volume planted in each tray • Spread seeds more evenly throughout the tray

FAILURE TO THRIVE



Identification	Remedy
<p>The greens look weak and pale. This is an all encompassing condition that could result from a number of factors. It is difficult to troubleshoot this condition if all of the other conditions above have been addressed.</p> <p>The weakness could be due to a lack of moisture control—either too dry or too wet. In some cases the seed is not properly planted, or the propagation dome is removed at the wrong time.</p>	<ul style="list-style-type: none"> • Make sure to read the seed growing instructions on the seed packaging • Stick to a regular watering schedule • Make sure you leave the propagation domes on for an adequate amount of time • If growing hydroponically, check your nutrient concentration and TDS levels; make sure nutrients are mixed according to the manufacturer's directions

*Mucilaginous seeds: seeds whose hull forms a gel sack consisting of proteins and polysaccharides when exposed to water. The purpose of this sack is to retain moisture around the seed during germination. It also assists the seed in holding onto the soil, so as not to be washed away while establishing a root to anchor the plant. Examples: brown mustard, arugula, basil, cress.

RESOURCES

Every GardenChef comes with a starter set of domes and trays. An optional starter kit is available and includes growing trays, domes, mats, sifter, TDS calibration solution, PH kit, hydrogen peroxide, 20 gallon plastic tub (for mixing/sifting soil) and measuring syringe (for adding nutrients)

Many supplies, including seeds and growing media, can be found at local greenhouses and urban garden supply sellers. The internet is a great resource for finding everything you need for your GardenChef. A list of some resources is on the next page.



Growing trays (with drain holes) and vented domes



TDS reader: for measuring the initial TDS of your water supply



Sterile soil or hydroponic growing media



Plastic tubs for mixing and sifting soil



Growing mats/filters to keep soil from running out of the trays into the water. Thicker mats can be used for hydroponic growing.



Seeds: purchase from reputable supplier



Rockwool or stonewool starter cubes/trays for hydroponic growing. Perlite may also be used. For discussion on hydroponic growing media, consult www.epicgardening.com

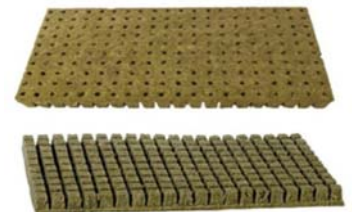

Sifter to sift dry soil to cover seeds for germination



Plant food: for hydroponic growing or seeds with longer growing cycles. Seeds with shorter growing cycles get enough nutrients from the soil



Measuring syringe to add nutrients

PH kit: PH#4 and PH#7 bottles to calibrate the pH probe.

TDS 1000 EC ppm solution: To calibrate the total dissolved solids probe



RESOURCES

List of brands for supplies*



Growing trays (with drain holes) and vented propagation domes:

Mondi™
Super Sprouter™
Sun Systems™



TDS reader:
Milwaukee™



Sterile soil:

Fox Farms Happy Frog™
Miracle Gro™

Hydroponic growing media (perlite, rockwool):

Handy Pantry™
Miracle Gro™
Therm-O-Rock™
Viagrow™
Plant It™
Grodan™

Plastic tub for mixing and sifting soil:

Rubbermaid™



Growing mats/filters:

Handy Pantry™

For discussion on hydroponic growing media, consult www.epicgardening.com

pH and TDS Calibration Solutions:

Nutradi™
General Hydroponics™



Seeds:

Johnny's Selected Seeds™
Burpee™
Eden Brothers™
Trueleaf Market

pH down and pH up solutions:

Nutradi™
General Hydroponics™
Botanicare™



Plant food:

Miracle Gro™
Jungle Juice™
General Hydroponics Flora Series™
Fox Farm Gringo Rasta,™ Bush Doctor™ and Hydroponic Trio™



* This is not a complete list or an endorsement of these products. Brands are trademarked and not affiliated with Carter-Hoffmann

REPLACEMENT PARTS & WIRING DIAGRAM

GARDENCHEF COMPONENTS 120V, 4.4 A

Part Number	Description	Part Number	Description
18301-2649	3" swivel poly caster with brake	18616-0424	power supply, 12 VDC, 120 VAC
18309-0048	4" adjustable S.S. leveling leg	18616-0438	Isolation board
18310-0209	22" drawer slide	18603-9125	remote control harness 8 pin USB cable, HUBA press transmitter
29038-5152	tempered glass door (GC41 & GC42)	18616-0425	press transmitter type 400
29038-5153	tempered glass door (GC11 & GC12)	18616-0418	ball valve 3/8" tube
29038-3259	polymatte light diffuser panel	18615-0168	tee 3/8" tube
18616-0415	T5 growing light fixture and bulb	18615-0161	rubber plug grommet 9600K44
18614-0314	muffin fan 115V	18617-0049	Solenoid valve HD 120
18614-0272	fan cover	18614-0035	muffin fan cord, 40" #4C552
18616-0224	transformer 120/208/240, 24V40VA	18614-0316	straight fitting 3/8" tube x 3/8" NPT
18615-0172	3/8" female NPT tube fitting	18616-0416	I/O board
18607-0017	terminal board CH03265	18616-0417	touch screen 4.3
18602-0002	water level float switch	18615-0169	rubber hose 1/4 ID x 3/8 OD
18605-0010	16/3 HSJO Cord w/ 5-15 plug	18615-0162	90 FTG 3/8" tube
18614-0399	Pressure regulator	18616-0422	CAT cable
18615-0176	Straight 1/2" NPT to 3/8" tube fitting	18615-0167	3/8" polyurethane tubing
18615-0179	Straight 1/4" NPT to 3/8" tube fitting	18304-0033	chrome door hinge
18615--0222	90 degree elbow 1/4" NPT to 3/8" tubing	18616-0434	EVA tubing, .188 ID x .312 OD
18616-0419	TDS sensor	18616-0435	.312 OD tension spring clamp
18616-0420	pH sensor	18616-0436	nylon loop clamp 1-1/2" ID
18616-0423	temperature/RH sensor w/housing	18616-0430	propagation tray with drain holes, 10" x 20"
18614-0115	water pump 12VDC	18616-0429	propagation 4" dome 10"x 20" w/ vents
18614-0396	recirculation pump 120VAC	18603-0011	pressure sensor cable
18614-0397	peristaltic pump 12VDC	18602-0009	EMI filter
18614-0118	water filter housing	16090-4100	Starter kit for GC11
18614-0121	water filter cartridge 4-7/8", 5 microns	16090-4099	Starter kit for GC12
18615-0174	replacement seal 4-3/8, 4-5/8, 5-3/8	16090-4081	Starter kit for GC41
18614-0033	solenoid valve 3/8" tube 5/16" ORF	16090-4088	Starter kit for GC42
18615-0166	3/8" bulkhead tube fitting		

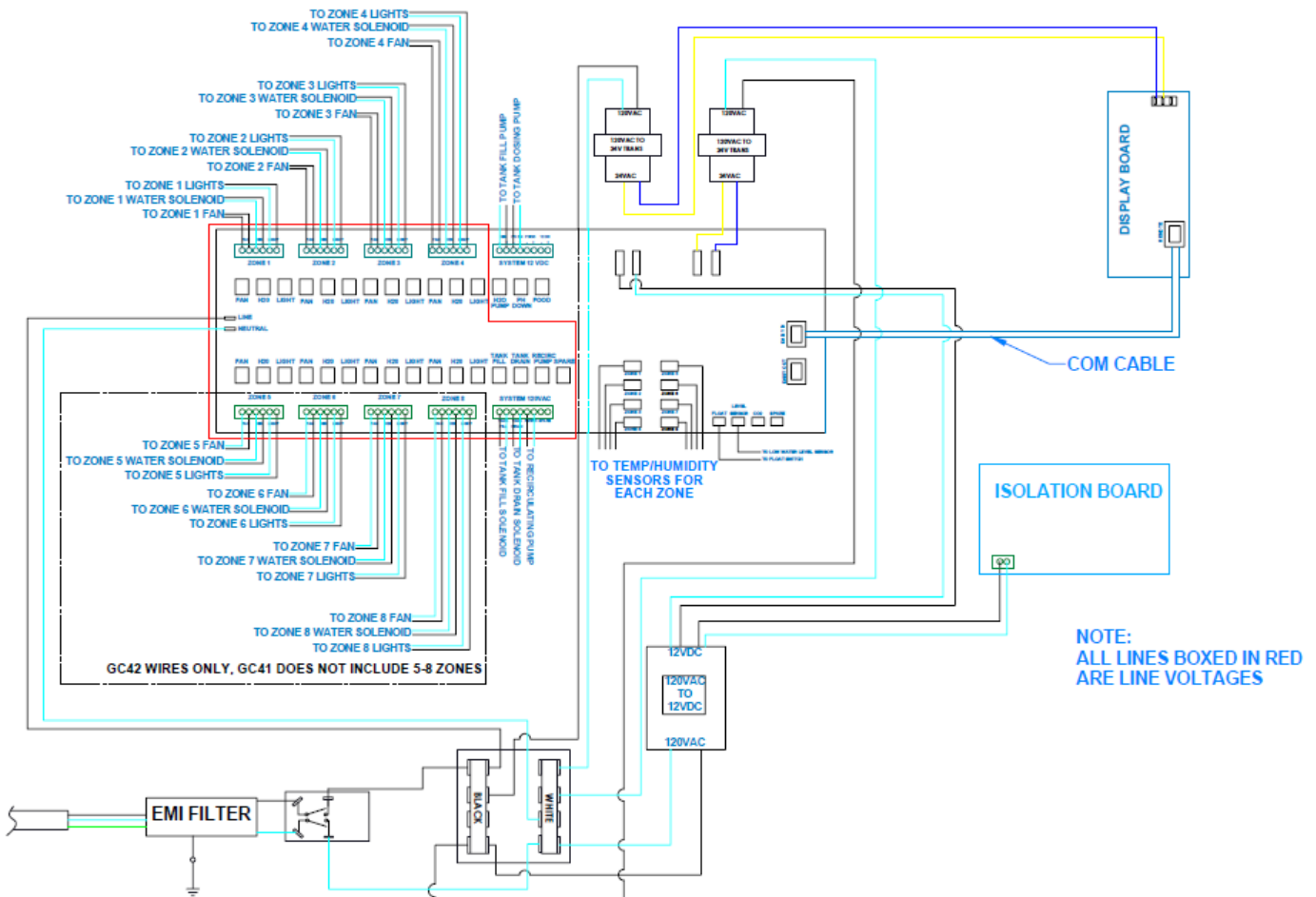

PLUMBING DIAGRAM



CAUTION: Use only (OEM) original equipment manufacturer replacement parts. Using unauthorized parts may cause serious injury or damage to the cabinet. Replacement parts should be installed by a qualified service technician.

Contact Carter-Hoffmann with your model and serial number for replacement parts.
 Call: 800-323-9793
 or email:
 technicalservice@carter-hoffmann.com

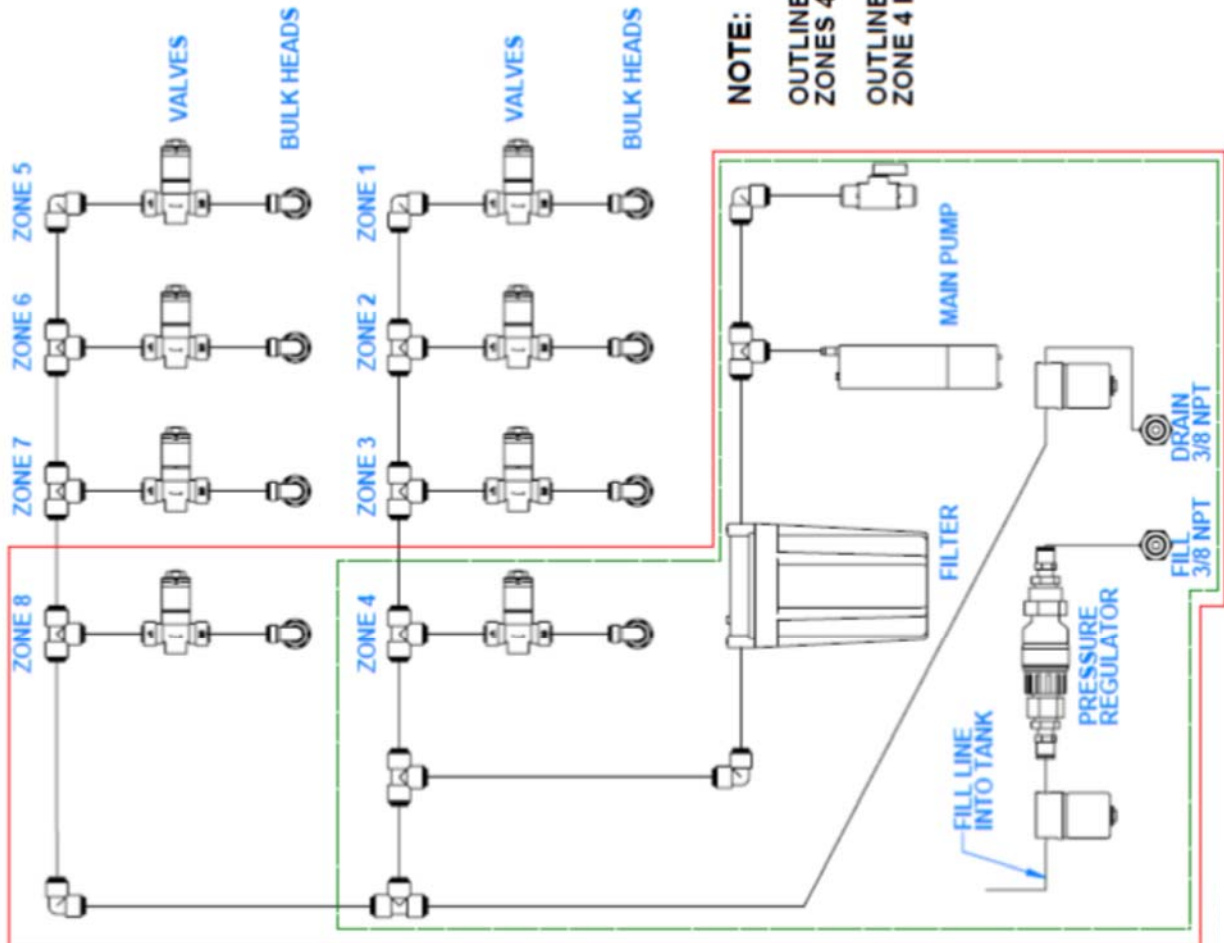

NOTE:

OUTLINED IN RED IS THE DIAGRAM FOR GC12 MODELS,
 ZONES 4 AND 8 ARE CONSIDERED ZONES 1 AND 2

OUTLINED IN GREEN IS THE DIAGRAM FOR GC11 MODEL,
 ZONE 4 IS CONSIDERED ZONE 1

WARRANTY

Carter-Hoffmann Warranty:

Carter-Hoffmann ("CARTER-HOFFMANN") warrants to the initial purchaser of its standard Carter Line Products that CARTER-HOFFMANN will, at its option, repair or replace, during the warranty period set forth below, any part of such products made necessary due to a defect in material or workmanship which is present when the product leaves its factory and which manifests itself during the warranty period under normal use and service.

*This warranty applies only to original equipment owned and possessed by the initial purchaser and the warranty period begins on the date of original shipment from the CARTER-HOFFMANN factory and extends as follows: **to component parts and labor for 12 months; to refrigeration compressor unit for one year** (limited to replacement only - not to include labor for removal, repair or replacement).*

Repair or replacements under this warranty will be performed, unless otherwise authorized in writing by CARTER-HOFFMANN, at its factory. All parts or components to be repaired or replaced under this warranty are to be shipped prepaid to CARTER-HOFFMANN, with reimbursement credit for such part or component to be given if found by CARTER-HOFFMANN to be defective.

CARTER-HOFFMANN neither makes nor assumes and does not authorize any other person to make or assume any obligation or liability in connection with its products other than that covered in this warranty. This warranty applies only within the continental United States and Canada. In Alaska and Hawaii, this warranty applies only to and is limited to the supply of replacement parts.

Warranty Exclusions and Limitations:

Any implied warranty of merchantability or fitness for a particular purpose is hereby specifically disclaimed by CARTER-HOFFMANN. There are no warranties, expressed or implied, which extend beyond the description on the face hereof. This warranty does not cover and CARTER-HOFFMANN shall not under any circumstances be liable for any incidental, consequential or other damages (such as injury to persons or property, loss of time, inconvenience, loss of business or profits, or other matters not specifically covered) arising in connection with the use of, inability to use, or failure of these products.

Specifications subject to change through product improvement and innovation.

Carter-Hoffmann

1551 McCormick Ave.

Mundelein, Illinois, 60060 USA

Phone: 847-362-5500 Toll free: 800-323-9793 Fax: 847-367-8981

Sales and Marketing E-mail: sales@carter-hoffmann.com

Service E-mail: technicalservice@carter-hoffmann.com

Company Website: www.carter-hoffmann.com

CFESA

Proud Member

NAFEM
North American Association of
Food Equipment Manufacturers