



Installation Guide



Model:

MDHHD

Tall hot water sanitizing machine w/fresh water rinse and built-in stainless steel electric booster



Issue Date: 10.11.19

Manual P/N 117118 rev. A

For machines beginning with S/N D190217104 and above

NATIONAL SERVICE DEPARTMENT

USA

Toll-free: 1-800-858-4477

Tel: (336) 661-1556

Fax: (336) 661-1660

Email: service@championindustries.com

Canada

Toll-free: 1-800-263-5798

Tel: (905) 562-4195

Fax: (905) 562-4618

Email: service@moyerdiebellimited.com

ATTENTION

The machine data plate
is located right front corner
of the front panel.



TWO WAYS to REGISTER YOUR PRODUCT and ACTIVATE YOUR WARRANTY.

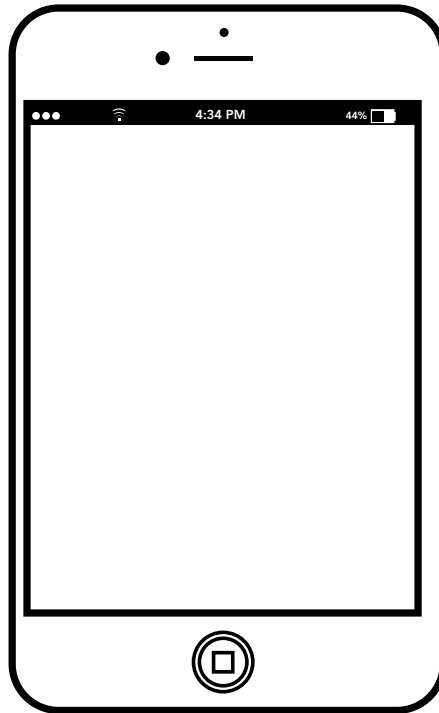

- Use your mobile device and connect to the website <https://www.championindustries.com/warranty-registration> to register your product.
- Complete the fax form on the next page and fax to 1-800 661-1660.

PRODUCT REGISTRATION BY FAX

COMPLETE THIS FORM AND FAX TO:

(336) 661-1660 in the USA

1-(800) 204-0109 in Canada

PRODUCT REGISTRATION CARD

| | |
|-------|----------|
| Model | Serial # |
|-------|----------|

Date of Installation: ___/___/___

Company Name: _____

Address: _____
(Street) State/Province Zip/Postal Code

Telephone #: () _____ --- _____

Contact: _____

Installation Company: _____

Address: _____

Telephone #: _____

Contact: _____

FAILURE TO REGISTER YOUR PRODUCT MAY VOID YOUR WARRANTY

IMPORTANT IMPORTANT

Revision History

Specifications are subject to change based on continual product improvement.

| <i>Revision Date</i> | <i>Revised Pages</i> | <i>Serial Number Effectivity</i> | <i>Revision Description</i> |
|----------------------|----------------------|----------------------------------|--|
| 4.29.19 | All | D190217104 | Released first edition |
| 6.10.19 | 12-17 | D190217104 | Added chemical dispensing & delime set-up |
| 8.5.19 | iv-xi | D190217104 | Added specification sheets |
| 9.16.19 | 9, 25 | All | Added 1-Point to 2-Point power connection conversion instructions. |
| 10.11.19 | 6,7,28 | D191018397 | Changed dependo-matic drain valve with metal electric valve. |

Limited Warranty

Limited Warranty

Moyer Diebel Limited (herein referred to as Moyer Diebel, 2674 North Service Road, Jordan Station, Ontario, L0R 1S0 and 3765 Champion Blvd., Winston-Salem, NC 27105) warrants machines, and parts, as set out below.

WARRANTY OF MACHINES: Moyer Diebel warrants all new machines of its manufacture bearing the name Champion, Moyer Diebel and/or Nexus and installed within the United States and Canada to be free from defects in material and workmanship for a period of one (1) year after the date of installation or fifteen (15) months after the date of shipment by Moyer Diebel, whichever occurs first. Products shipped outside of United States and Canada do not have warranty. The warranty registration card must be returned to Moyer Diebel within ten (10) days after installation. Warranty registration must be submitted to Moyer Diebel within ten (10) days after installation either online at: <https://www.championindustries.com/warranty-registration>, or by fax on the form provided in the front of this manual if warranty card is not returned to Moyer Diebel within such period, the warranty will expire after one year from the date of shipment. Moyer Diebel will not assume any responsibility for extra costs for installation in any area where there are jurisdictional problems with local trades or unions. If a defect in workmanship or material is found to exist within the warranty period, Moyer Diebel, at its election, will either repair or replace the defective parts, machine or accept return of the machine for full credit. In the event that Moyer Diebel elects to repair, the labour and work to be performed in connection with the warranty shall be done by a Moyer Diebel "Authorized Service Agent" during regular working hours and will be covered at normal rates and any additional overtime rate will be at the responsibility of the equipment purchaser. Warranty is covered up to 50 miles or 80 km's of travel from a Moyer Diebel authorized service technician. If travel exceeds 50 miles or 80 km's, then the end user will be responsible for additional travel expense. Service calls initiated under warranty that are found to not contain any defects in materials or workmanship, will not be covered by Moyer Diebel. Defective parts become the property of Moyer Diebel. Use of non OEM replacement parts not authorized by Moyer Diebel will relieve Moyer Diebel of all liability in connection with its warranty. In no event will Moyer Diebel's warranty obligation exceed Moyer Diebel's charge for the machine. Models that come with a factory paid start-up will be limited to one visit. Machines found to have issues related to installation procedures, or delays of any kind, will not be covered by Moyer Diebel and the sole responsibility of the equipment purchaser.

The following are not covered by Moyer Diebel's warranty:

- a. Element tubes and/or squeeze tubes.
- b. Vacuum breakers.
- c. Replacement of fuses or resetting of overload breakers, or high limits.
- d. Adjustment of thermostats, or temperature controlling devices.
- e. Adjustment of clutches.
- f. Adjustments of water pressure(s).

- g. Adjustments of chemical pumps.
- h. Opening or closing of utility supply valves or switching of electrical supply current.
- i. Cleaning of valves, strainers, screens, nozzles, or spray pipes.
- j. Performance of regular maintenance and cleaning as outlined in operator's guide.
- k. Damages resulting from water conditions, accidents, alterations, improper use, abuse, tampering, improper installation, low voltage conditions, inadequate wiring, outdoor use, or failure to follow maintenance and operation procedures.
- l. Wear on Pulper cutter blocks, pulse vanes, and auger brush.
- m. Damages due to improper storage.
- n. Special installations or applications, including remote locations, are limited in coverage by this warranty. Any installation that requires extra work, and/or travel, to gain access to the unit for service is the sole responsibility of the equipment purchaser.

Examples of the defects not covered by warranty include, but are not limited to:

1. Damage to the exterior or interior finish as a result of the above.
2. Use with utility service other than that designated on the rating plate.
3. Improper connection to utility service.
4. Inadequate or excessive water pressure.
5. Corrosion from foreign materials, water supplies, improper chemicals, or chemicals dispensed in excess of recommended concentrations.
6. Failure of electrical components due to connection of chemical dispensing equipment installed by others.
7. Leaks or damage resulting from such leaks caused by water quality, or the installer, including machine table connections or by connection of chemical dispensing equipment installed by others.
8. Failure to comply with all local building codes.
9. Damage caused by labor dispute.

WARRANTY OF PARTS: Moyer Diebel warrants all new machine parts produced or authorized by Moyer Diebel to be free from defects in material and workmanship for a period of 90 days from date of invoice. If any defect in material and workmanship is found to exist within the warranty period, Moyer Diebel will replace the defective part without charge.

DISCLAIMER OF WARRANTIES AND LIMITATIONS OF LIABILITY. MOYER DIEBEL'S WARRANTY IS ONLY TO THE EXTENT REFLECTED ABOVE. MOYER DIEBEL MAKES NO OTHER WARRANTIES, EXPRESS OR IMPLIED, INCLUDING, BUT NOT LIMITED TO, ANY WARRANTY OF MERCHANTABILITY, OR FITNESS OF PURPOSE. MOYER DIEBEL SHALL NOT BE LIABLE FOR INCIDENTAL OR CONSEQUENTIAL DAMAGES. THE REMEDIES SET OUT ABOVE ARE THE EXCLUSIVE REMEDIES FOR ANY DEFECTS FOUND TO EXIST IN MOYER DIEBEL DISHWASHING MACHINES AND MOYER DIEBEL PARTS, AND ALL OTHER REMEDIES ARE EXCLUDED, INCLUDING ANY LIABILITY FOR INCIDENTALS OR CONSEQUENTIAL DAMAGES.

Moyer Diebel does not authorize any other person, including persons who deal in Moyer Diebel dishwashing machines, to change this warranty or create any other obligation in connection with Moyer Diebel Limited dishwashing machines.

Table of Contents

| | |
|---|-----|
| Revision History | i |
| Limited Warranty | ii |
| Installation Codes and Safety Symbols | xii |
| | |
| Installation | 1 |
| Receiving and Placement..... | 1 |
| Dish Table Connections..... | 2 |
| Corner Operation - Corner Splash Shield..... | 3 |
| Corner Operation - Track Conversion..... | 4 |
| Standard Hot Water Connection | 5 |
| Drain Connection | 6 |
| Optional Drain Water Tempering Kit | 7 |
| Electrical Connections - Single and Three Phase..... | 8 |
| Single and Two Point Power Connections..... | 9 |
| Converting 3-Phase to 1-Phase Operation | 10 |
| Optional Built-in Detergent and Rinse-aid Dispensing System | 11 |
| Program the Chemical Dispensing System | 12 |
| Delime Programming..... | 16 |
| Detergent Concentration Graphs | 17 |
| Detergent Probe/Signal For Chemical Dispensing Systems by others..... | 18 |
| Rinse-aid Injector/Signal for Chemical Dispensing Systems by others..... | 19 |
| Shortening a Chemical Pick-up Hose Supplied by Others | 20 |
| | |
| APPENDIX A: MDHH Corner Splash Shield Kit, P/N 901104 | 21 |
| APPENDIX B: Kit P/N 901168, 1 to 2-point Electrical Connection Conversion | 25 |
| APPENDIX C: Manually Operating the Drain Valve..... | 28 |

Installation Codes

The installation of the dishwasher must comply with all local electrical, plumbing, health and safety codes or in the absence of local codes, installed in accordance with the applicable requirements in the National Electrical Code, NFPA 70, Canadian Electrical Code (CEC), Part 1, CSA C22.1; and the Standard for Ventilation Control and Fire Protection of Commercial Cooking Operations, NFPA 96.



CAUTION:

Damage or problems associated with improper installation will not be covered by the limited warranty.

Safety Symbols

The following symbols are used throughout this manual to alert the reader to important information.



WARNING:

Warning statements indicate a condition or practice that can result in personal injury or possible death.



CAUTION:

Caution statements indicate a condition or practice that can result in damage to the machine or associated equipment.



NOTE:

Note statements highlight important information necessary for the operation of the machine.

Receiving



Inspect the outside of the shipping carton for signs of damage and report any damage immediately to a supervisor.

Remove the carton, inspect the dishwasher, and check the inside of the machine for accessories and installation parts.

Register your machine by fax or online as soon as possible.



CAUTION:

Be careful when lifting and moving the machine to avoid damage.

Placement

Compare the installation site utility connections with the dishwasher utility connections to ensure they are the same.

Provide 20" [508 mm] on right, left and front sides of the machine and 27" [686 mm] above the finished floor.

The dishwasher has four adjustable feet for leveling. Level the dishwasher front-to-back and side-to-side.



NOTE:

Dishwashers are shipped from the factory for straight-through operation but are field convertible to corner operation.

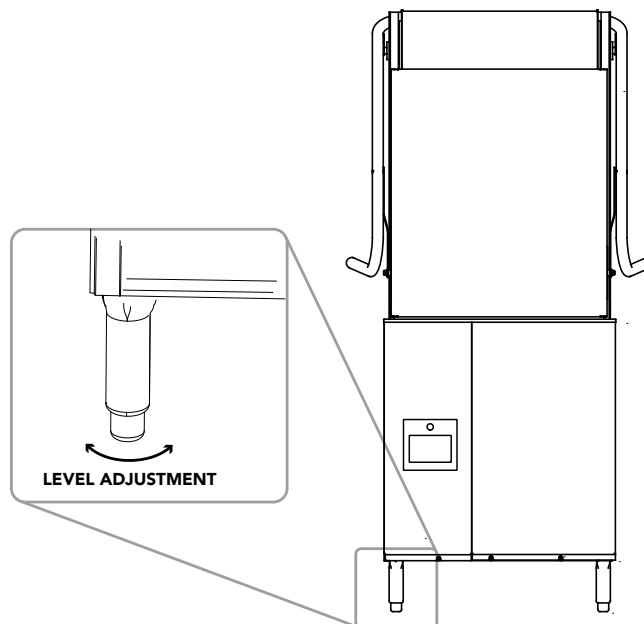

Fig. 1

Dish Table Connections



CAUTION:

Do not attach the dish tables until the dishwasher is set in its permanent location.

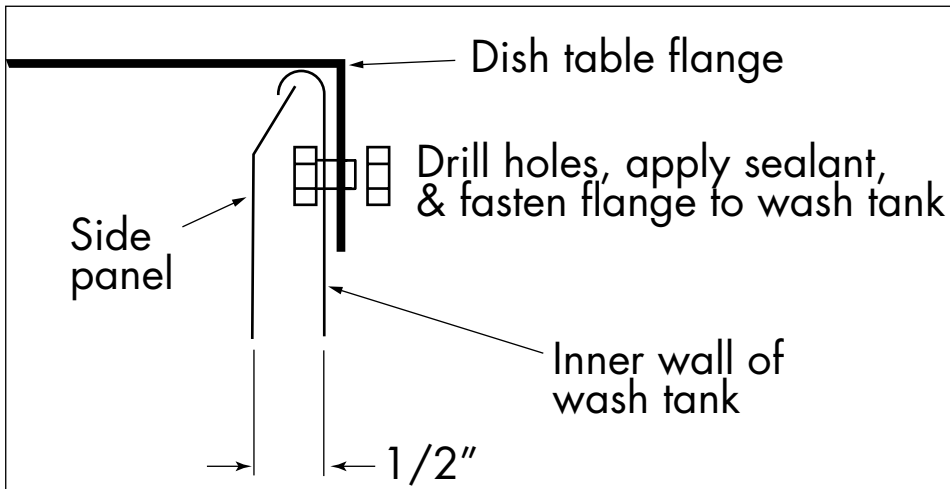

Fig. 2

Level the dishwasher and dish tables to the required height. Fit the dish table flanges over the ends of the dishwasher tank and mark two hole locations. Drill 1/4" holes through the table flange and the dishwasher tank. Apply sealant between the table flanges and the wash tank and install stainless steel 1/4-20 fasteners to secure.

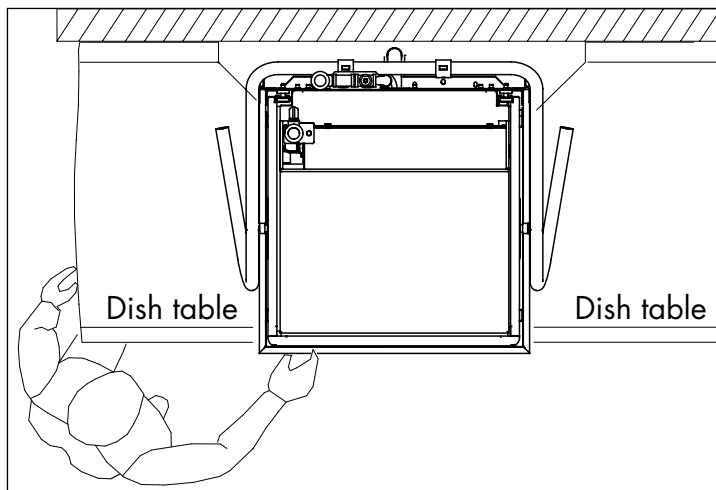

Fig. 3

Corner Operation - Corner Splash Shield

Machines are shipped from the factory for straight through operation. To convert to for corner operation:

1. The control panel must be accessible from the front as shown in Fig. 4.
2. Install the optional splash shield, if included with machine, see Fig. 5. Detailed instructions can be found in Appendix A at the rear of this manual.

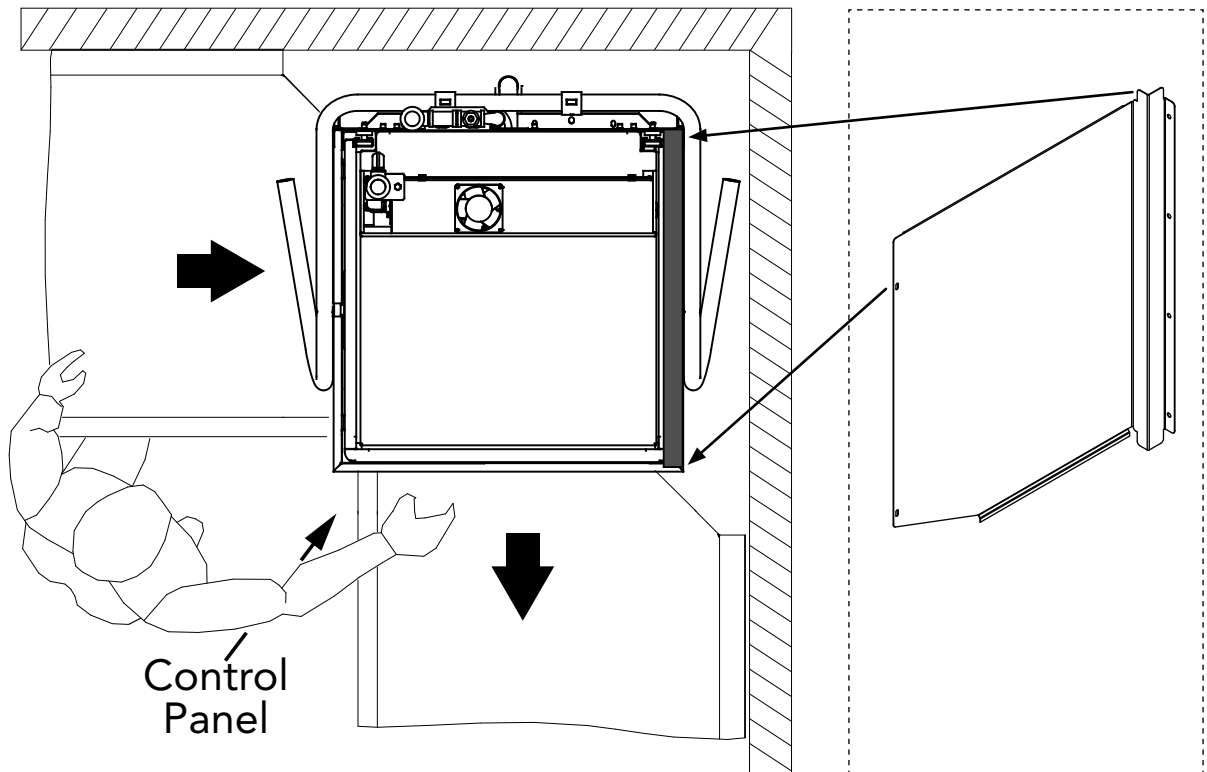

Fig. 4

Fig. 5



NOTE:

TRACK CONVERSION INSTRUCTIONS ARE ON THE NEXT PAGE.

Corner Operation - Track Conversion

Follow the steps below to convert the track assembly for corner operation:

1. Pull the track assembly straight up out of the machine.
2. Rotate the track 180° and reinstall.
3. Remove the guide attached to the track assembly, save the hardware.
4. Reposition the guide on the right-hand side of the track assembly and secure with the existing fasteners.
5. Slide a dish rack through the machine to ensure it moves freely.
6. Conversion is complete.

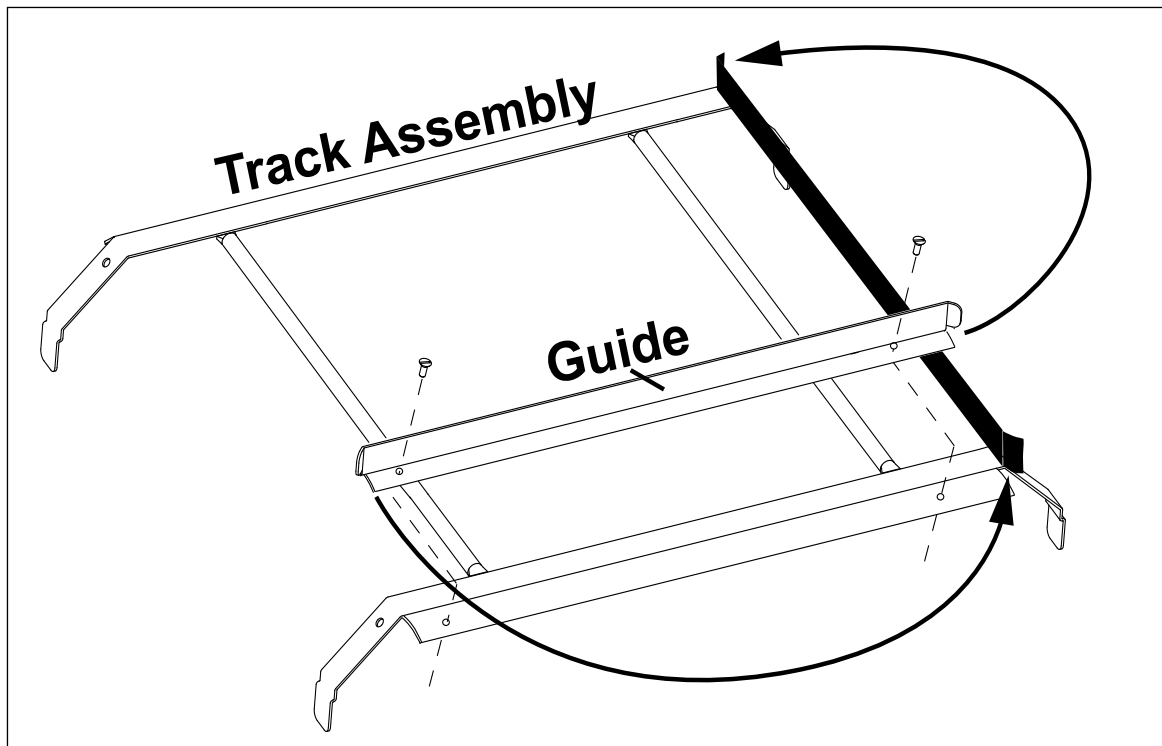

Fig. 6

Hot Water Connection



**HOT
WATER**

MINIMUM 3/4" NPT HOT WATER SUPPLY

MINIMUM/MAXIMUM INCOMING
TEMPERATURE

110-140°F/43-60°C

MINIMUM INCOMING
SUPPLY FLOWING PRESSURE

45 PSI / 310 kPa

MINIMUM/MAXIMUM
OPERATING FLOWING PRESSURE

18-20 PSI / 124-138 kPa



CAUTION: To prevent damage to the dishwasher supply valves, the installing plumber must thoroughly flush debris from the water supply line before connecting it to the dishwasher. Damage caused by improper installation is not covered by the limited warranty.

WATER HARDNESS OF 3 GRAINS/US GAL - 0.83 IMP GAL - 5.3mg/L OR LESS.

INSTALL A 3/4" OR LARGER FULL PORT SHUT-OFF VALVE IN THE WATER SUPPLY LINE AS CLOSE TO THE DISHWASHER AS POSSIBLE FOR SERVICING.

Drain Connection



DRAIN

GRAVITY DRAIN, 1-1/2" NPT CONNECTION



CAUTION: The dishwasher drain connection must comply with all local plumbing, health and safety codes. Damage caused by improper installation is not covered by the limited warranty

AUTOMATIC ELECTRIC DRAIN VALVE

MAXIMUM FLOW RATE: 15 US GPM/12.5 IMP. GPM/ 57LPM



Fig. 7



CAUTION:
Use caution when making drain valve plumbing connections.

NOTE:

Manually Operating the Drain Valve Instructions can be found on page 28.

Drain Water Tempering Kit

A drain water tempering field installation kit P/N 117084 is included with the machine.



**COLD
WATER**

ELECTRIC WATER VALVE

MINIMUM 1/2" NPT COLD WATER SUPPLY LINE

USES BUILDING FLOWING PRESSURE

MINIMUM/MAXIMUM INCOMING
TEMPERATURE

55-75°F / 13-24°C

MINIMUM INCOMING
SUPPLY FLOWING PRESSURE

45 PSI / 310 kPa

MINIMUM/MAXIMUM
OPERATING FLOWING PRESSURE

18-20 PSI / 124/138 kPa

WATER HARDNESS OF 3 GRAINS/US GAL - 0.83 IMP GAL - 5.3mg/L OR LESS.



Fig. 8

Installing the kit:

1. Installations should be done by a plumber in accordance with local plumbing codes.
2. Turn water and power off to the machine.
3. Remove panels.
4. Do not use sweat connections on any part of the kit to avoid damage to the tempering valve.
5. Connect the tempering valve to the drain line as close to the hot water discharge as possible.
6. Connect a 1/2" NPT cold water line to the tempering valve.
7. The installation of a ball shut-off valve (supplied by others) for servicing is highly recommended.
8. Maintain an INDIRECT (air gap) connection to the floor drain, if the exit of the Tee is finished to the floor drain.
9. Restore water supply and check for leaks.
10. Restore power and test the operation of the machine.
11. Replace panels.
12. Installation is complete.

Electrical Connection - Single and Three Phase



WARNING:
 Electrocutation may occur when working on energized circuits. Disconnect power at the main breaker or service disconnect switch, then lock out and tag it to indicate that work is being performed on the circuit.

1. Remove the right and front panels and position the machine near the final location.
2. Route conduit to the mounting bracket located at the right rear corner of the machine (see Fig. 9). Be sure to leave a 6 foot / 2 meter service loop to the machine.
3. Remove the right and front panel to access the main terminal blocks. The machine may have a one or two point electrical connection.
4. Follow the Machine Electrical Connection Data Plates for the terminal block connections. The data plates are glued in front of the blocks (Fig. 11).



Fig. 9

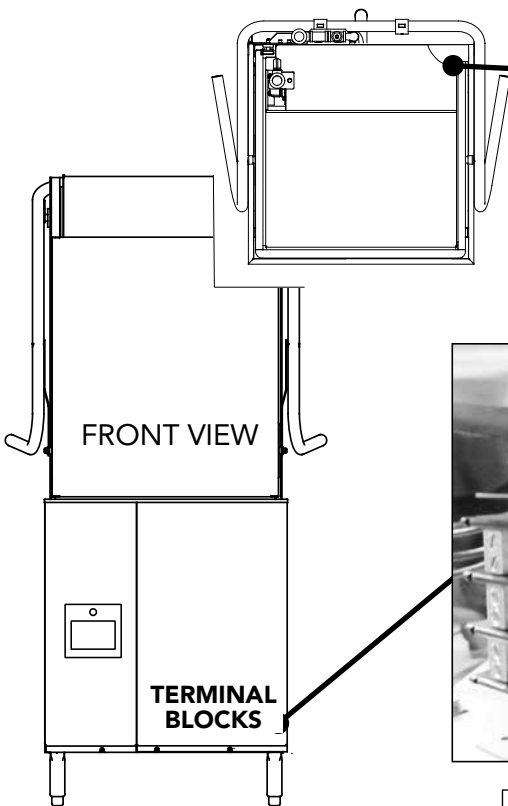

Fig. 10

| 2-Point Booster Connection Data Plate | | | |
|--|---------------------|---------------|-------------------|
| Mod: MDHHD | Series: STD. | | |
| For supply connection, use copper connectors in accordance with local electrical code. Rated Minimum 90°C (194°F). | | | |
| Overcurrent Protection Device: Time Delay or Inverse Time Circuit Breaker | | | |
| Minimum Supply Conductor Ampacity | 50/50 | AMPS | |
| Maximum Supply Overcurrent Protection Device | 50/50 | AMPS | |
| Volt: 208-240 | Ph: 3 | Hz: 60 | Amp: 39-34 |

Fig. 11

Electrical Connection - Single and Three Phase



WARNING:

There may be more than one power source connected to the machine. Make sure all power sources are disconnected, locked and tagged out before working on the machine.

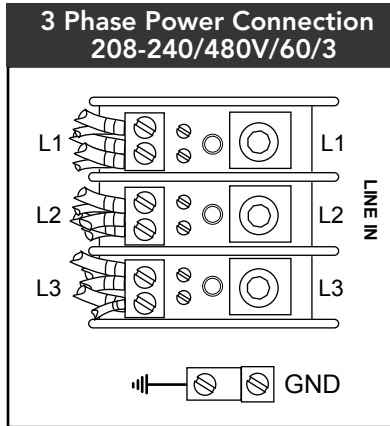

Fig. 12

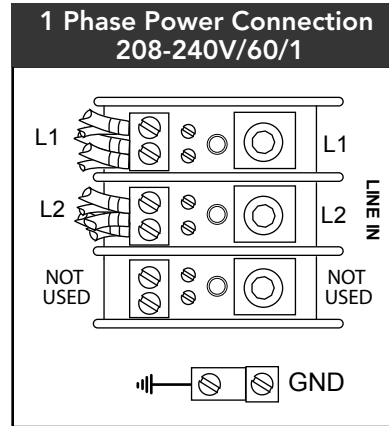
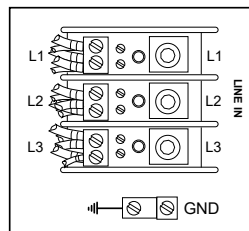

Fig. 13

Single to Two Point Power Connection Conversion

1. Machine wiring can be converted from a single to a two point input power connection by installing a field conversion kit, P/N 901168.
2. New electrical connection data plates must be applied in front of the input terminal blocks.
3. Refer to Appendix B at the end of this manual for conversion instructions.



| 2-Point Machine Connection Data Plate | | | |
|--|--------------|---------------|-------------------|
| Mod: MDHHD | Series: STD. | | |
| For supply connection, use copper connectors in accordance with local electrical code. Rated Minimum 90°C (194°F). | | | |
| Overcurrent Protection Device: Time Delay or Inverse Time Circuit Breaker | | | |
| Minimum Supply Conductor Ampacity | 50/50 | AMPS | |
| Maximum Supply Overcurrent Protection Device | 50/50 | AMPS | |
| Volt: 208-240 | Ph: 3 | Hz: 60 | Amp: 38-34 |

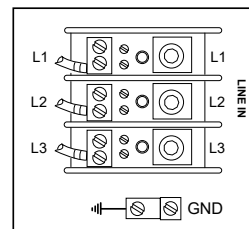

| 2-Point Booster Connection Data Plate | | | |
|--|--------------|---------------|-------------------|
| Mod: MDHHD | Series: STD. | | |
| For supply connection, use copper connectors in accordance with local electrical code. Rated Minimum 90°C (194°F). | | | |
| Overcurrent Protection Device: Time Delay or Inverse Time Circuit Breaker | | | |
| Minimum Supply Conductor Ampacity | 50/50 | AMPS | |
| Maximum Supply Overcurrent Protection Device | 50/50 | AMPS | |
| Volt: 208-240 | Ph: 3 | Hz: 60 | Amp: 39-34 |

Fig. 14

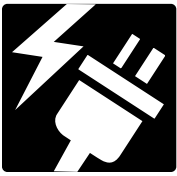

Converting 3 Phase to 1-Phase Operation

Convert 3 Phase to 1 Phase by installing of a jumper wire on the input power block and rewiring the wash tank and booster tank heaters. A jumper wire, jumper bars and a new data plate are stowed inside the control cabinet.

TO CONVERT:

Install Main Terminal Block Jumper Wire

1. Disconnect all power to the machine.
2. Remove front panel to access the power terminal block.
3. Connect jumper wire (shipped inside control cabinet) between L2 and L3 on output side of block.
4. Connect power on L1 and L2 of the terminal block.

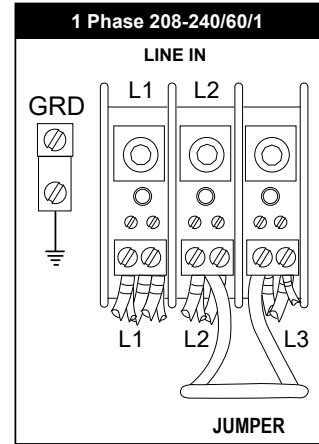

Rewire Wash Tank Heater Element for 1PH

1. Remove the paper insulator and jumper bars from the heater terminals.
2. Additional short jumper bars are stowed with the new data plate.
3. Reposition the jumper bars for 1PH as shown.
4. Reconnect the heater wires as shown.
5. Reinstall the paper insulator.

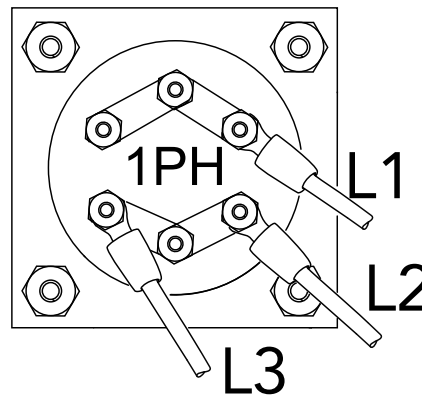

Rewire Booster Heater Element for 1PH

1. Remove the booster heater element cover.
2. Remove the paper insulator and jumper bars from the heater terminals.
3. Install the jumper bars for 1PH as shown.
4. Additional short jumper bars are stowed with the new data plate.
5. Connect the wires to the terminals as shown.
6. Reinstall the paper insulator and the booster heater element cover.

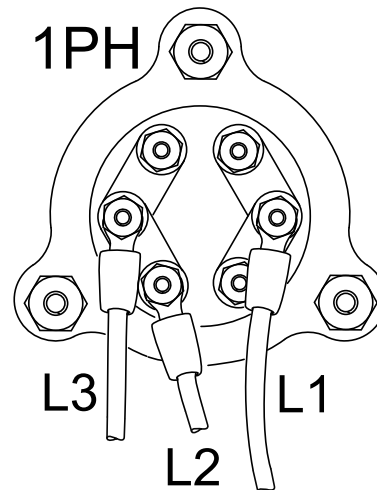

Fig. 15

DET R/A **OPTIONAL BUILT-IN DETERGENT AND RINSE-AID DISPENSING SYSTEM (IF EQUIPPED)**

1. Detergent and rinse-aid dispensing pumps are located on left-side of machine (Fig. 16).
2. Pick-up tubing (Fig.17) exits left-side of machine to containers. The pick-up tubes are stowed on the back of the machine (Fig. 18).
3. Rinse-aid is dispensed in the final rinse manifold at the top rear of machine. (Fig. 19). Two 7/8" diameter holes are on right-side of machine for detergent sensor and injector (Fig. 20).

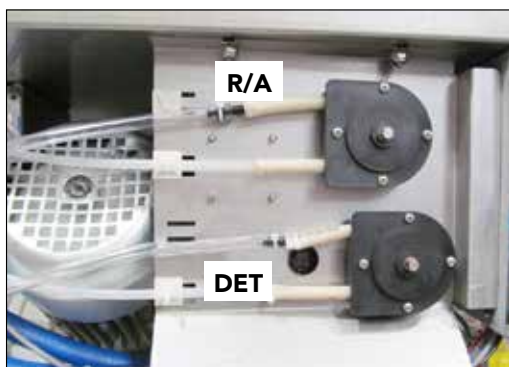

Fig. 16



Fig. 19

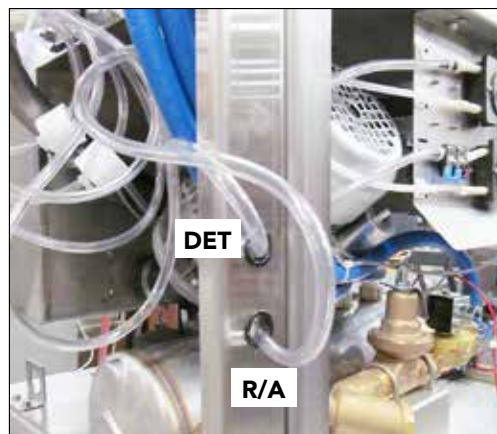

Fig. 17

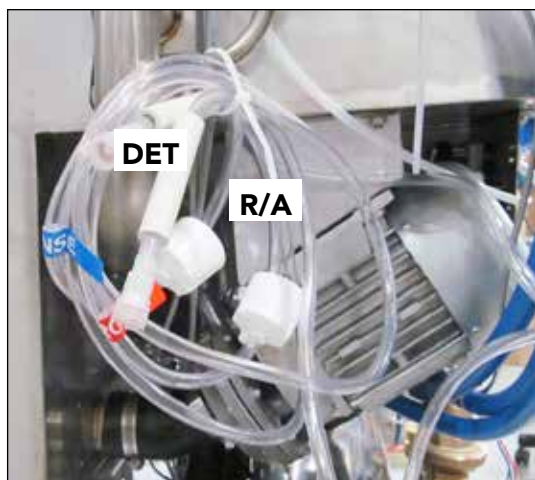

Fig. 18



Fig. 20



OPTIONAL BUILT-IN DETERGENT AND RINSE-AID DISPENSING SYSTEM (IF EQUIPPED)

Program the Chemical Dispensing System

Use the digital touchscreen display to enter operating settings. Refer to the instructions below to set the system parameters.

System Prep

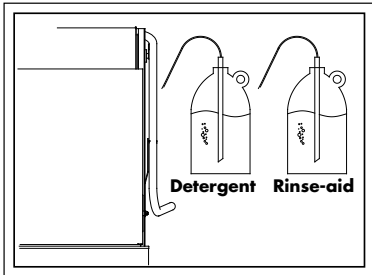

1. Place pick-up tubes in full containers.

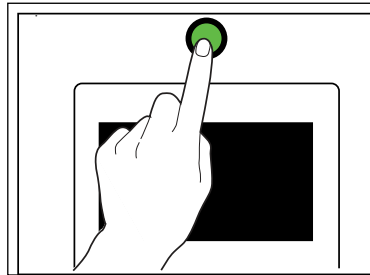

2. Press power button on. Button will illuminate and machine will begin to fill.

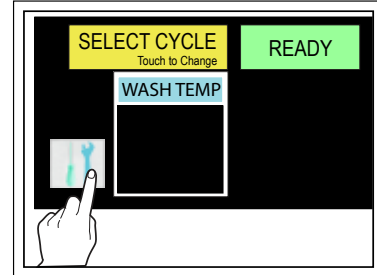

3. Press 'TOOLS' to access the main settings screen.

Main Settings Screen

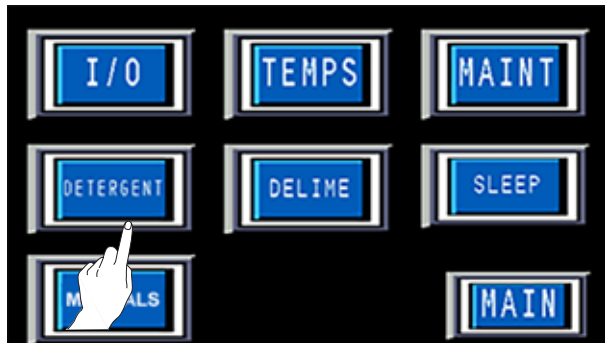

LEGEND - Main Settings

| | |
|-----------|---------------------------------------|
| I/O | Input and Output Screen |
| TEMPS | Temperature monitoring screen |
| MAINT | Maintenance Menu |
| DETERGENT | Detergent & R/A settings |
| DELIME | Forces machine into delime mode |
| SLEEP | Idle time before sleep (PW protected) |
| MAIN | Return to the main operating screen |

NOTE: The Cycle Times, Concentration, Rinse Aid and Sleep settings are PW protected. The DET PRIME and RA PRIME are free access.

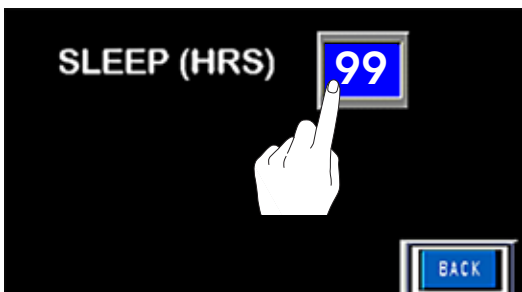

Password Protected Sleep -- PW = 7777

Press 99 and enter "7777" in keypad to access setting.
Sets number of hours the machine must sit idle before washand booster tank heaters turn off to save energy.
Factory Default: 99 hours.

PW = 7777 Cycle Times, Concentration, and Rinse Aid

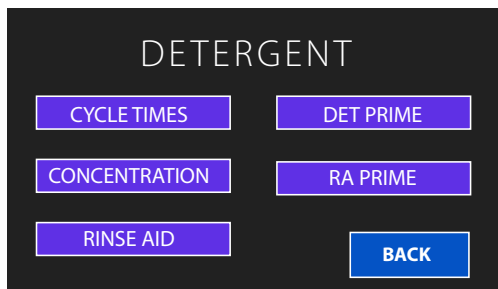

LEGEND - Detergent/Rinse-aid Settings

| | |
|---------------|---|
| CYCLE TIMES | Sets the run times for the detergent pump |
| CONCENTRATION | Sets detergent concentration in wash tank |
| RINSE AID | Sets the rinse-aid pump run time |
| DET PRIME | Press to prime Detergent pump |
| RA PRIME | Press button to prime rinse-aid pump |
| BACK | Returns to main settings screen above |



NOTE: Press the button, enter "7777" and Enter on the keypad to access cycle times, concentration, and rinse-aid. Prime buttons are not password protected.

Cycle Times -

Initial Fill: Sets time detergent pump runs during machine fill.

Factory Default Initial Fill Setting:

Enter 4 for Sodium Hydroxide based detergent

Enter 30 for Potassium Carbonate based detergent

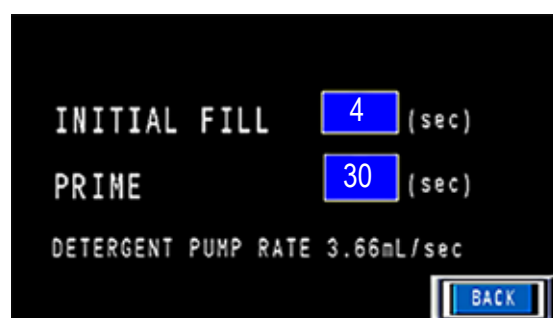

Prime: Sets the time detergent pump runs to prime detergent line when:

- machine is turned on for first time and line is initially charged or reset button is pressed to clear an alarm.
- Factory Default Prime Setting: 30 sec.



The tank detergent sensor must remain clean to ensure accurate readings. Clean sensor with a soft cloth each day.

Detergent Concentration -

- Set Point and Concentration are relative values and not indicative of actual PPM or concentration.
- For best results: Consult the chemical manufacturer's recommendation for concentration and PPM.
- Perform a titration test to determine the proper concentration has been achieved.

Set Point: Sets required detergent concentration in wash tank measured in millivolts.

Concentration: Actual value being measured in the tank measured in millivolts.

Tank Temp: The detergent sensor will not add detergent unless the tank temperature is greater than 150°F and one complete wash cycle has run.

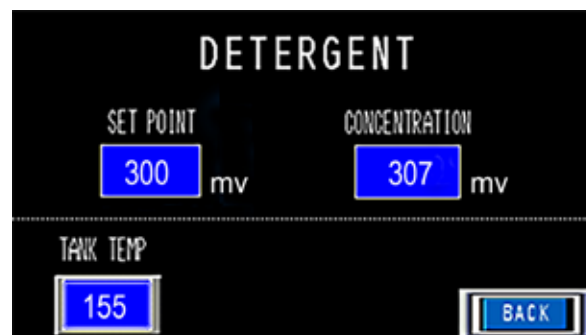

Factory Default Set Points:

Enter 300 for Sodium Hydroxide based detergent.

Enter 500 for Potassium Carbonate based detergent.

DETERGENT CONCENTRATION GRAPHS

Based on manufacturer's recommended concentration.

(Pink) Sodium Hydroxide 10-30% concentration

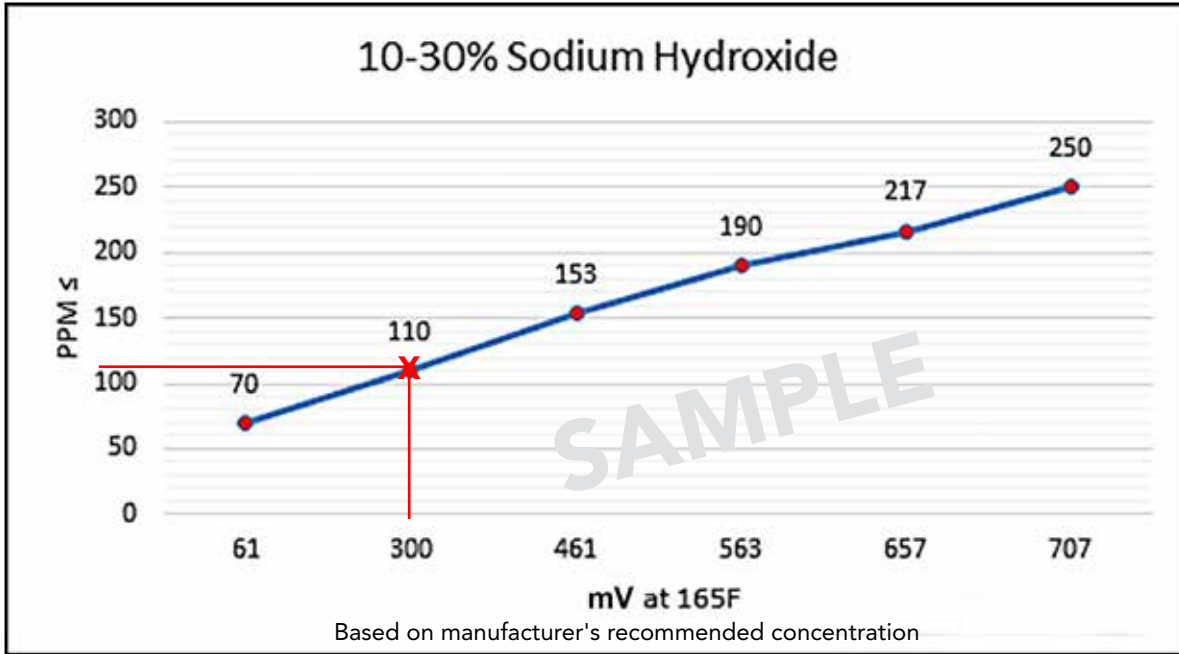

(Yellow) Potassium Carbonate 17% concentration

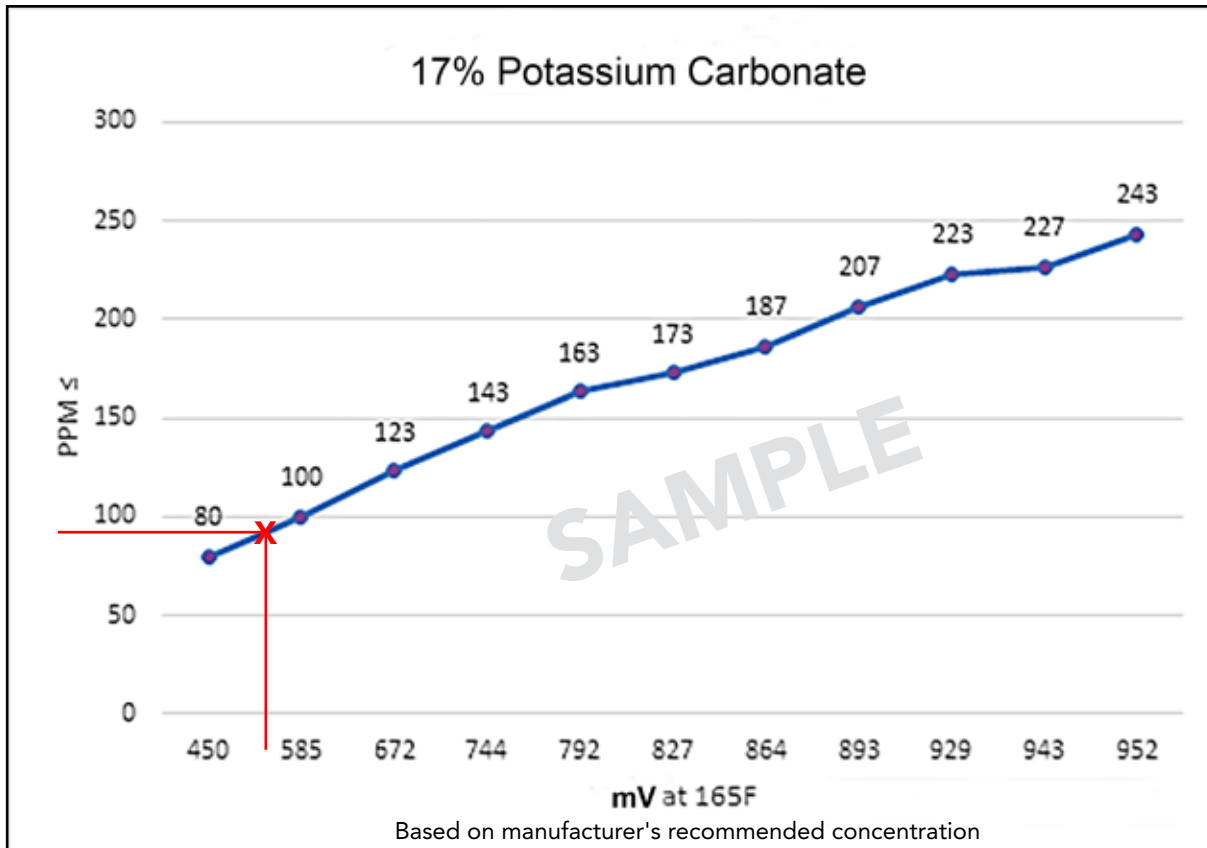

DET R/A Programming

Rinse-aid Cycle -

Sets the time the rinse-aid pump runs during final rinse.

Factory Default = 5 sec.

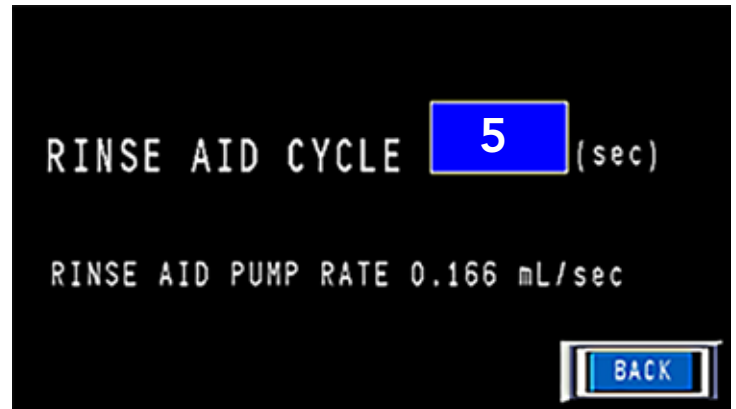

Manual Priming (Password Free)

- The Detergent Prime (DET PRIME) and Rinse aid Prime (RA PRIME) do not require password access.
- Press the desired button until chemical fills the lines and release.

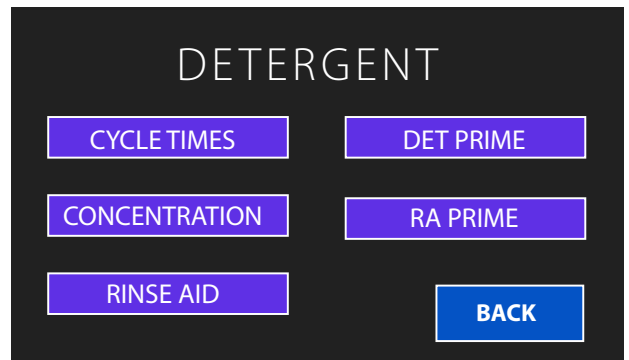



OPTIONAL BUILT-IN DETERGENT AND RINSE-AID DISPENSING SYSTEM (IF EQUIPPED)

Disabling the Optional Dispensing System

The detergent/rinse aid dispensing system can be disabled if desired using the 'MAINT' programming function. The VHR system can be disabled on the same screen. To disable:

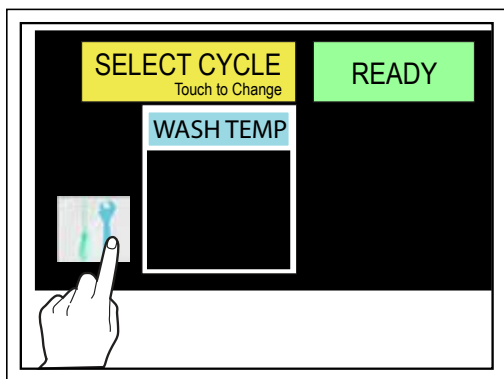

1. Press the 'TOOLS' button on the MAIN screen.

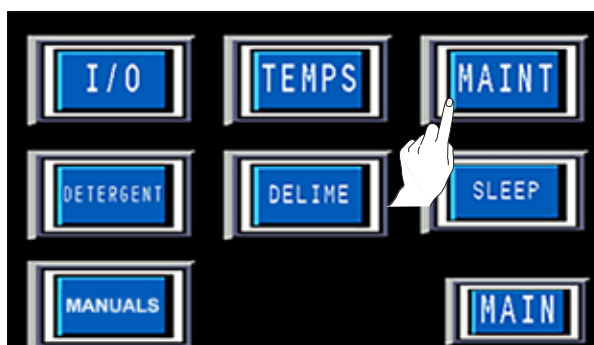

2. Press the 'MAINT' button to access the password keypad.

| Password | | | | | | |
|----------|---|---|------|---|---|-----|
| USER 2 | ▲ | ▼ | **** | | | |
| A | B | C | D | E | F | CAN |
| G | H | I | J | K | L | |
| M | N | O | P | Q | R | CLR |
| S | T | U | V | W | X | |
| Y | Z | 0 | 1 | 2 | 3 | ENT |
| 4 | 5 | 6 | 7 | 8 | 9 | |

3. Press '9999' and ENT.

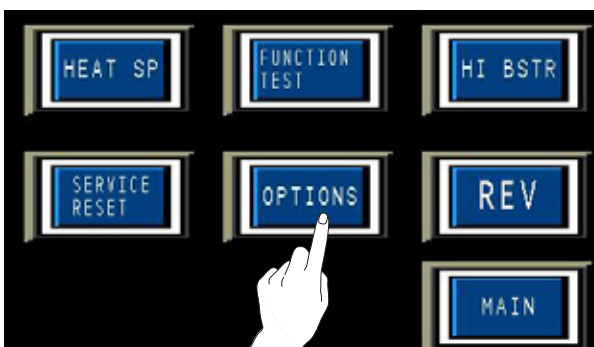

4. Press the 'OPTIONS' button.

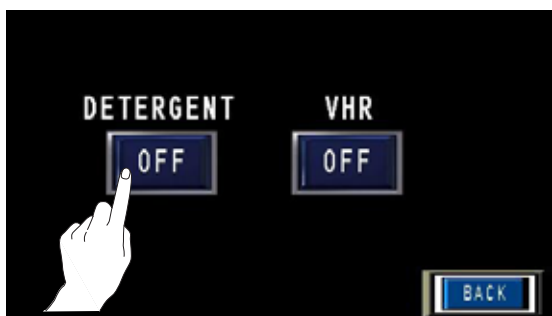

4. Press 'DETERGENT' or 'VHR' to disable either function.

NOTE:
Factory default settings are 'ON'.

DELIME Programming

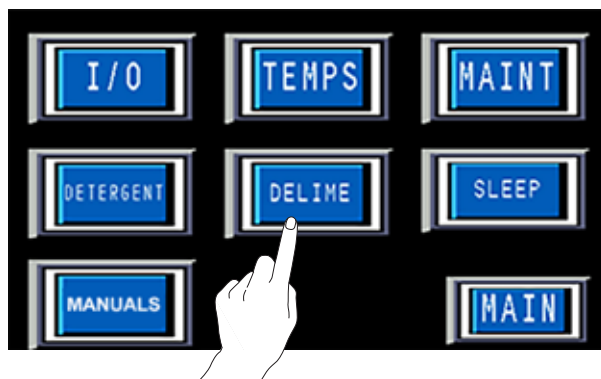
- The DELIME button accesses two functions: DELIME SET-UP and DELIME START.

- Press 'DELIME SETUP' and enter password "7777" to access the settings. Factory Default Settings are:

- DELIME = OFF
- HOURS = 0
- Delime Wash = 20
- Delime Rinse = 5



LEGEND - DELIME SET-UP

| | |
|--------------|---|
| DELIME | Default = OFF/ ON activates the clock |
| HOURS | TIME in run hours before alarm on display |
| Delime Wash | Time in minutes the machine wash delimes |
| Delime Rinse | Time in minutes the machine rinses |
| BACK | Press button to go back one screen |

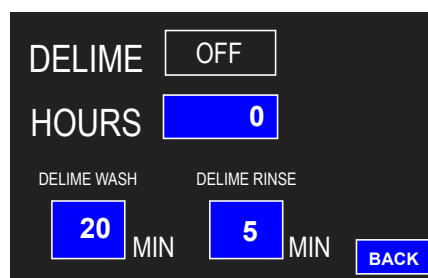

DELIME START

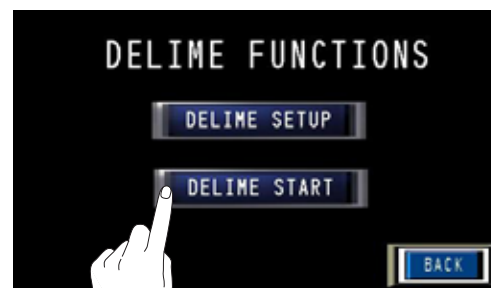

- Press DELIME START to begin. The box below appears to confirm the selection. Pressing "YES" begins deliming, "NO" cancels it.
- Follow the on screen delime instructions.

 The delime process will not start until the delime set-up parameters have been entered for delime wash and delime rinse.

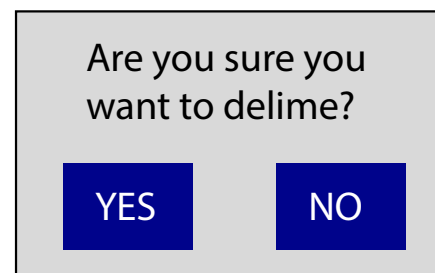

Detergent Probe and Injection Point for Chemical Dispensing System by others.



WASH TANK CAPACITY: 10 US GAL/8.3 IMP. GAL/38 L

TWO 7/8" DIAMETER HOLES AT LOWER RIGHT REAR CORNER OF TANK.
- TOP HOLE IS DETERGENT INJECTION
- BOTTOM HOLE IS DETERGENT PROBE.

SIGNAL ENABLED DURING WASH CYCLE.

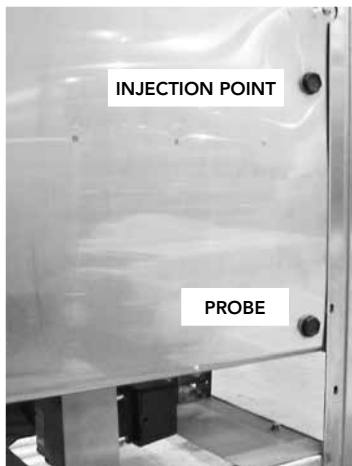

Fig. 21

Detergent Signal for Chemical Dispensing System by others.

120VAC FUSE BLOCK-1.5 AMP-
MAX LOAD DETERGENT SIGNAL
CONNECTION. LOCATED ON FRONT
BASE.

SIGNAL ENABLED DURING WASH CYCLE.

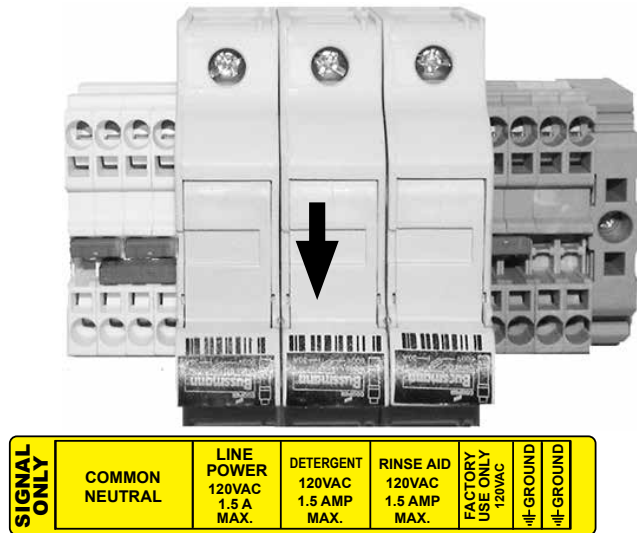

Fig. 22

Rinse-aid Injector for Chemical Dispensing System by others.

R/A

STD. RINSE/RACK: .73 US GAL/.61 IMP. GAL/ 2.8L
 POT,PAN,RINSE/RACK .73 US GAL/.61 IMP.GAL/ 2.8L

1/8" NPT PIPE PLUG AT THE REAR OF THE MACHINE
 NEAR THE VACUUM BREAKER FOR RINSE-AID INJECTION.

SIGNAL ENABLED DURING FINAL RINSE CYCLE.

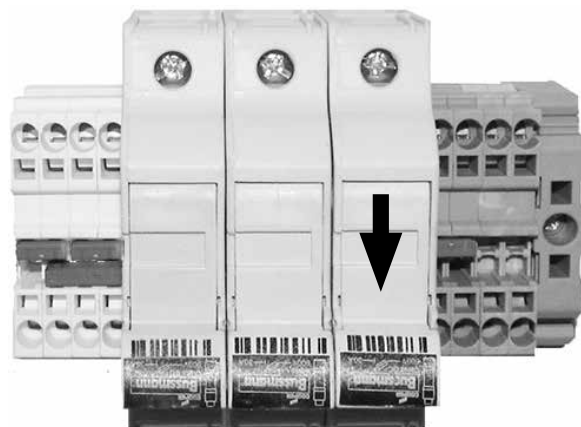

Fig. 23

Rinse-aid Signal for Chemical Dispensing System by others.

120VAC FUSE BLOCK-1.5 AMP-
 MAX LOAD RINSE-AID SIGNAL
 CONNECTION. LOCATED ON
 FRONT BASE.

SIGNAL ENABLED DURING FINAL
 RINSE CYCLE.



| | | | | | | | |
|--------------------|----------------|---------------------------------------|--|--|-------------------------------|----------|----------|
| SIGNAL ONLY | COMMON NEUTRAL | LINE POWER 120VAC 1.5 A MAX. | DETERGENT 120VAC 1.5 AMP MAX. | RINSE AID 120VAC 1.5 AMP MAX. | FACTORY USE ONLY 120VAC | F-GROUND | F-GROUND |
| | | | | | | | |

Fig. 24

Shortening a Chemical Pick-up Hose Supplied by Others

1. Remove the left-side panel to access the detergent and rinse-aid chemical pumps (Fig. 1).
2. The chemical tubes enter from the rear through grommets (Fig. 2).



Fig. 2



Fig. 1

3. Remove the existing cable-ties. (Fig. 3).
4. Shorten hoses and re-install the hose barb fittings (Fig. 4).

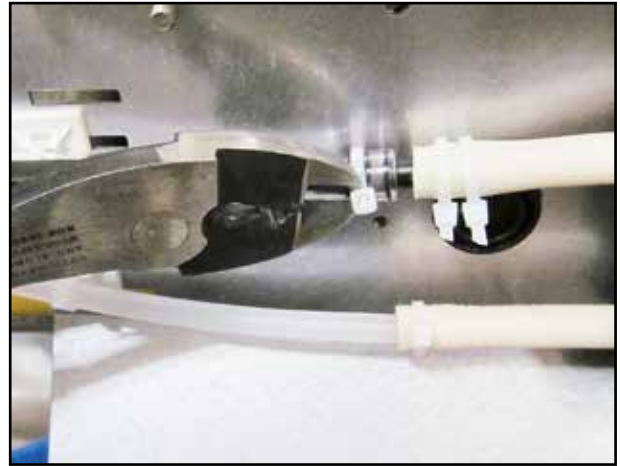

Fig. 3

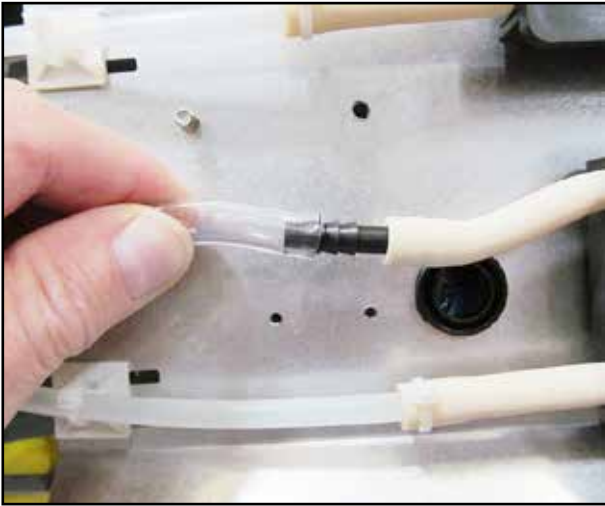

Fig. 4

5. Make sure all cable-ties are in place and secure (Fig. 5).
6. Procedure Complete.

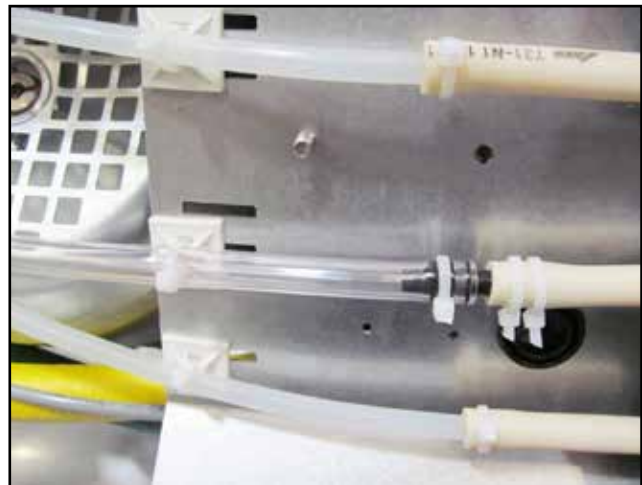

Fig. 5

INSTALLING CORNER SPLASH SHIELD KIT, P/N 901114



CAUTION:

Turn off dishwasher power. The machine will drain automatically.

KIT PARTS: (1) SHIELD, CORNER SPLASH, P/N 337955, COMPOUND SEALING, P/N 104889, (2) SCREWS, 10-32 X 1/2" TRUSS HEAD, P/N 100097, (2) WASHER, FLAT, 10-32, P/N 107033, NUT, GRIP, 10-32 W/NYLON INSERT, P/N 107966

SPECIAL TOOLS: #21 or 5/32" Drill bit, Electric Drill

1. The splash shield is installed on the right-hand side of the dishwasher. (Fig. 1).

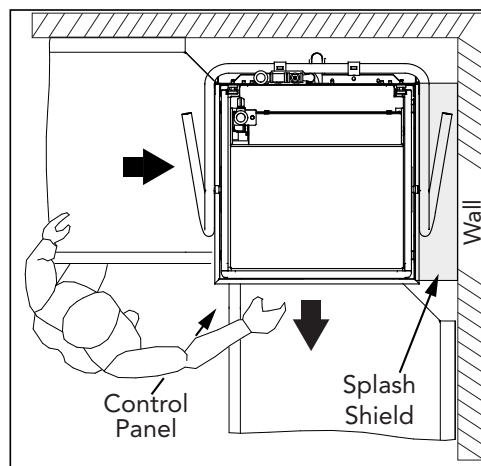

Fig. 1

2. Turn dishwasher power off; the machine will drain automatically. Open the doors.
3. Lift and remove the track assembly (Fig. 2).



Fig. 2

APPENDIX A: Installing Corner Splash Shield Kit P/N 901114

4. Remove the (4) bolts, locks, and washers securing the right-hand door guide cover. Save the fasteners and discard the cover (Fig. 3).



Fig. 3

5. Install the splash shield between the door guide and the front corner post (Fig. 4). The left side of the splash shield covers the door guide.



Fig. 4

APPENDIX A: Installing Corner Splash Shield Kit P/N 901114

6. Apply a small bead of sealing compound to the (4) fasteners saved in step 4. Secure the guide cover end of the splash shield to the machine (Fig. 5).

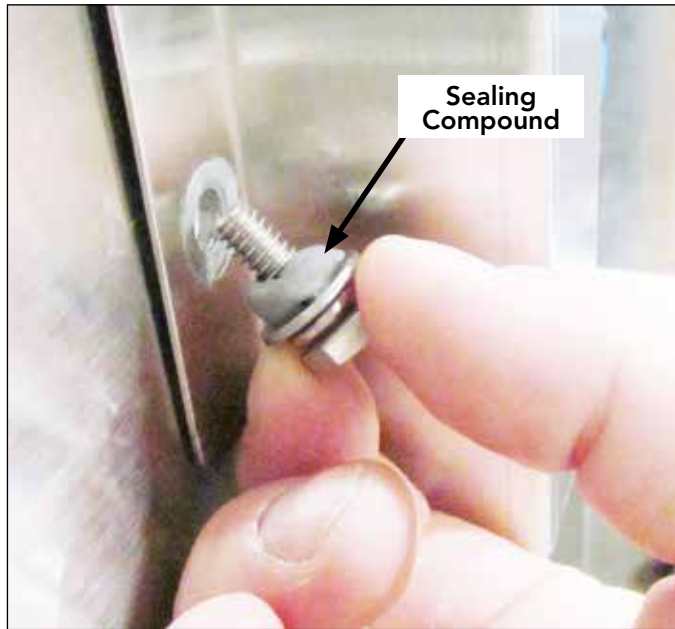

Fig. 5

7. Locate the mounting holes on the right-hand front corner. (Fig. 6).

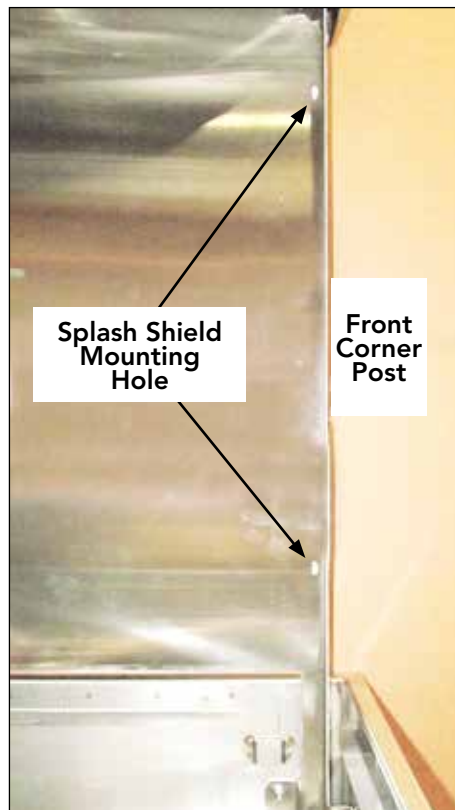

Fig. 6

APPENDIX A: Installing Corner Splash Shield Kit P/N 901114

- Using the splash shield as a template, mark and drill two holes in the corner post.
Secure the shield to the post using the 10-32 screws, nuts and washers provided in the kit.



Fig. 7

- Open and close the doors to ensure there is no interference between the doors and shield.
- Turn the dishwasher power on to fill the dishwasher.
- The installation is complete.



ATTENTION:
**THE CORNER POSTS MAY BE PREDRILLED AND WILL NOT REQUIRE
THE POSTS TO BE DRILLED IN STEP 8.**

MDHH Series 1-Point to 2-Point Electrical Connection Conversion Kit, P/N 901168



WARNING:

Disconnect all power to the dishwasher before working on the machine.

KIT PARTS:

- (1) P/N 111833, Input Terminal Block
- (1) P/N 336386, Bracket, Incoming Electrical
- (2) P/N 107136, Screw, 10-23 x 3/8" Hex Hd.,
- (2) P/N 107966, Grip Nut, w/nylon Insert,
- (4) P/N 100007, Screw, 10-32 x 3/8" Truss Hd.,
- (1) P/N 116045, Matrix Label, 2-Point Electrical Data Plate, (Printed in-house)
- (1) P/N 117097, Instruction Sheet,

SPECIAL TOOL: 1/4" DRILL BIT
(not included in kit)



Fig. 1

1. Disconnect power to the dishwasher and remove the front panels.
2. Locate MACHINE input terminal block on right front corner of machine base (Fig. 2).
3. Identify the booster wires L1, L2, and L3.
4. Disconnect the wires. **Note: L1 is on top of the block, L3 on bottom.**
5. Install the kit terminal block to the bracket using (4) 10-32 truss head screws (Fig. 3).



Fig. 3

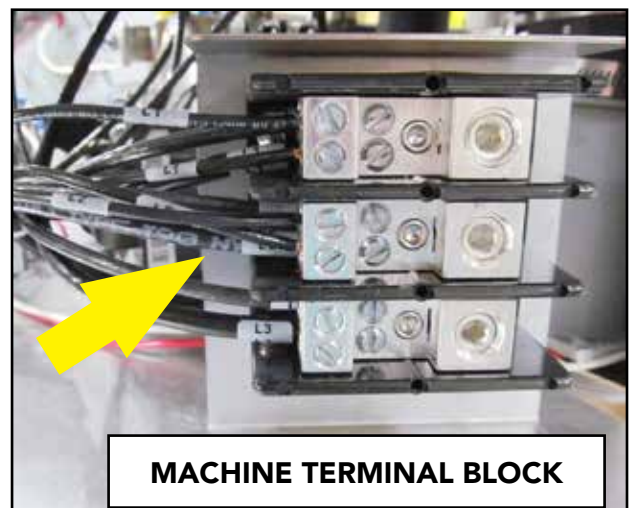

Fig. 2

APPENDIX B: 1-Point to 2-Point Electrical Connection Conversion, Kit P/N 901168

6. Position the Booster terminal block and make sure the booster wires disconnected in step 4 will reach to the block. (Fig. 4).



Fig. 4

7. The base should be predrilled for the bracket, however, if not, then use the bracket as a template and mark two holes (Fig. 5).

8. Drill the holes.



Fig. 5

9. Mount the bracket using two 10-32 Hex screws and grip nuts from the kit (Fig. 6).



Fig. 6

APPENDIX B: 1-Point to 2-Point Electrical Connection Conversion, Kit P/N 901168

10. Connect the booster wires to the booster terminal block (Fig.7).

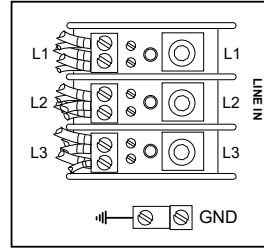

| 2-Point Machine Connection Data Plate | | | |
|--|--------------|--------|------------|
| Mod: MDHHD | Series: STD. | | |
| For supply connection, use copper connectors in accordance with local electrical code. Rated Minimum 90°C (194°F). | | | |
| Overcurrent Protection Device: Time Delay or Inverse Time Circuit Breaker | | | |
| Minimum Supply Conductor Ampacity | 50/50 | AMPS | |
| Maximum Supply Overcurrent Protection Device | 50/50 | AMPS | |
| Volt: 208-240 | Ph: 3 | Hz: 60 | Amp: 38-34 |

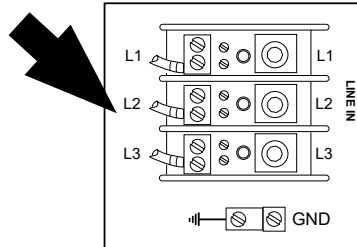

| 2-Point Booster Connection Data Plate | | | |
|--|--------------|--------|------------|
| Mod: MDHHD | Series: Std. | | |
| For supply connection, use copper connectors in accordance with local electrical code. Rated Minimum 90°C (194°F). | | | |
| Overcurrent Protection Device: Time Delay or Inverse Time Circuit Breaker | | | |
| Minimum Supply Conductor Ampacity | 50/50 | AMPS | |
| Maximum Supply Overcurrent Protection Device | 50/50 | AMPS | |
| Volt: 208-240 | Ph: 3 | Hz: 60 | Amp: 38-34 |

Fig. 7

11. Cover the existing 1-Point machine connection data plate with 2-Point Machine connection data plate from the kit. Install the 2-Point booster data plate adjacent to the booster terminal block (Fig. 7 and Fig. 8).



Fig. 8

12. Restore power and check the operation of the machine.
13. Re-install panels.
14. Conversion is complete.

Manually Operating the Drain Valve



- To manually operate the new valve, four 2.5mm socket allen screws must be removed, the valve coil removed, and the valve globe rotated with pliers.

- The valve coil has an indicator line showing valve position. Ensure valve is reassembled in the same position.



1

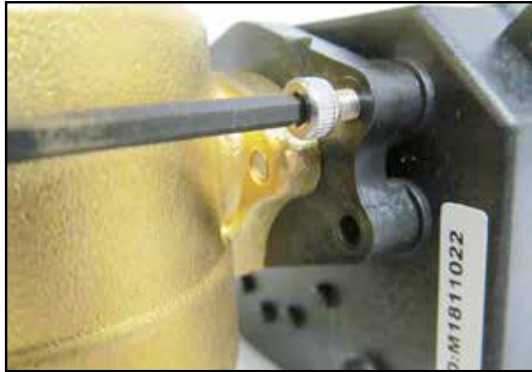

Remove four 2.5mm coil retaining allen screws.

2



Remove the coil from the valve body.

3

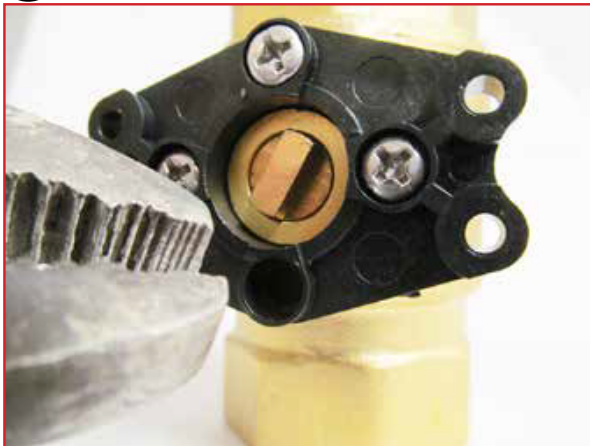

Using pliers, turn the valve body key to the vertical position to open valve.

Reassemble in reverse order.

MDHHD Operation Guide

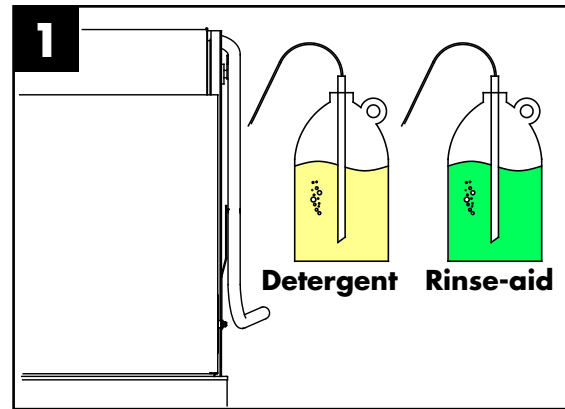

Check the chemical levels in the containers.

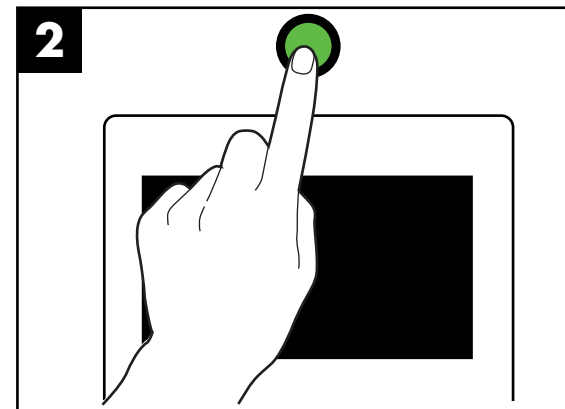

Close door & press the green power button.

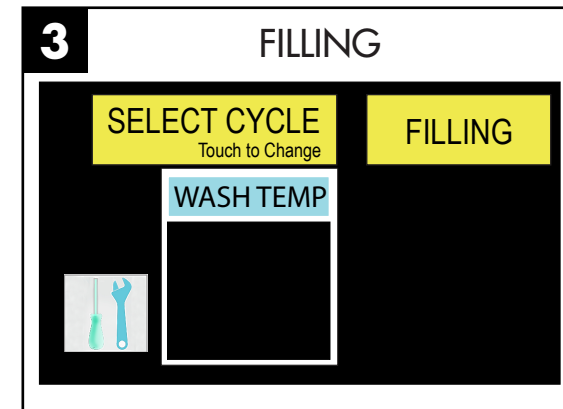

'FILLING' appears as the machine begins to fill automatically.

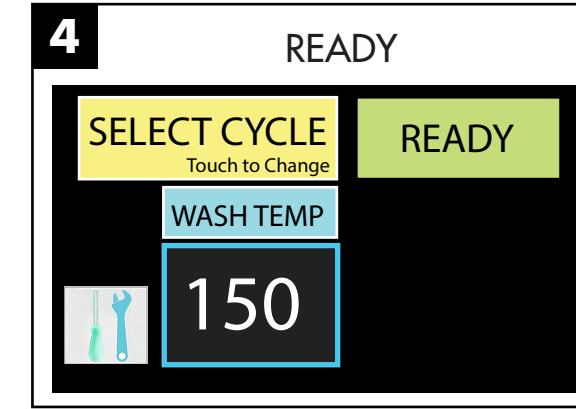

'READY' appears on the screen once it is ready to wash. Please allow machine to preheat 15-20 minutes prior to use.

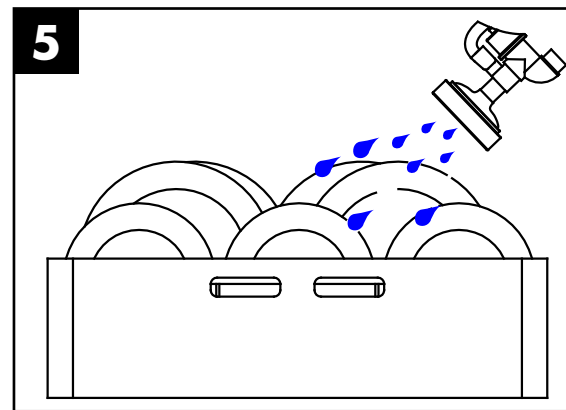

Prescrap and load wares into the machine. Wash one rack at a time.

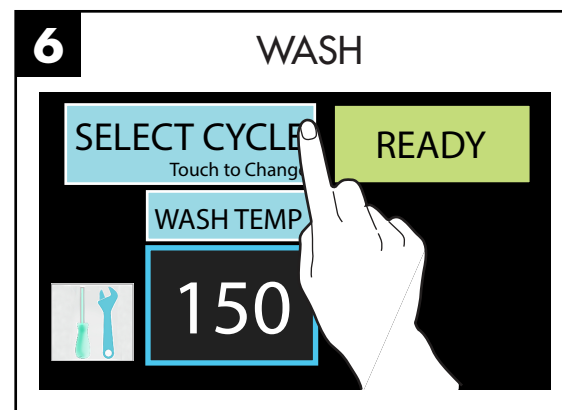

Close door and press 'SELECT CYCLE' for 1, 2, 4 or 6 minutes. The selected time cycle will begin.

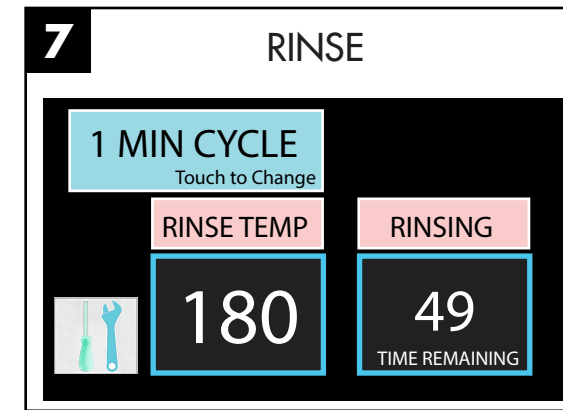

Monitor the final 'RINSE TEMP' to ensure it maintains a minimum of 180°F during the final rinse.

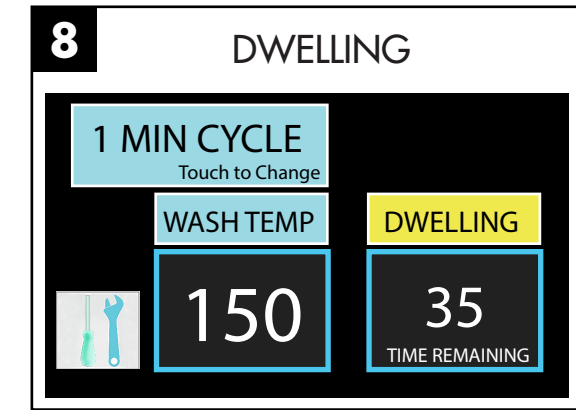

'DWELLING' appears after the final rinse cycle.



'READY' appears at the end of the cycle. Open the door and remove the clean wares.

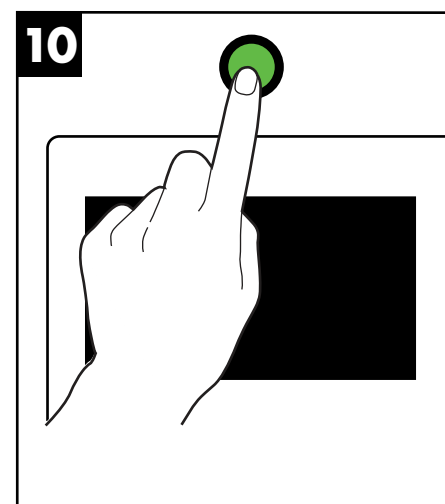

To Drain the Machine:

- Open the doors and remove wares from machine.
- Push the green power button.
- The display screen will blank out.
- The drain valve opens for 10 minutes to allow the machine to drain completely.
- The machine powers off.
- Pushing the power switch on and immediately off will initiate another 10 minute drain cycle.