

N | Gnd

Combustion Blower Fan

Gas Valve Assembly

Convection Fans

115 VAC

115 VAC

L

N

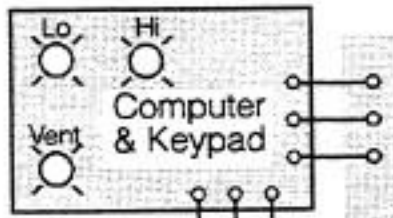
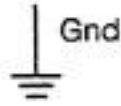

*partial schematic of BMR-32, showing temperature control circuitry*

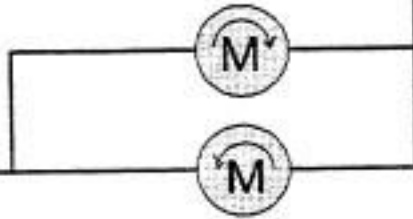

Convection Fans

Fan (8 sec. delay on)

24VAC

24VAC

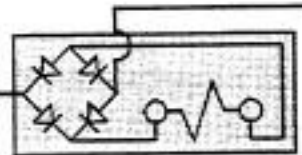

Vent Solenoid

Vent

Lo Fire

Combustion Fan Prover

Hi-Limit

Relay Interface Board

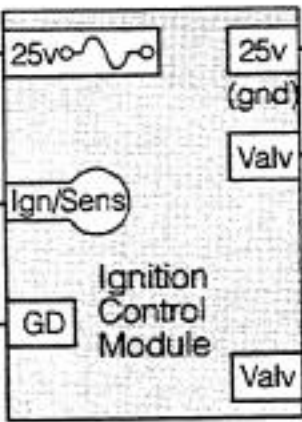

Ignition Control Module

Gas Valve Assembly

Pilot  
Main  
High

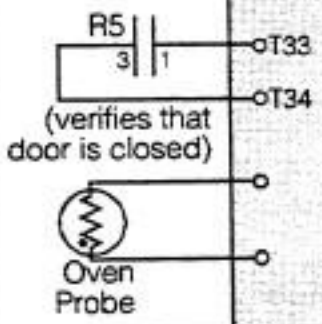

Over Probe

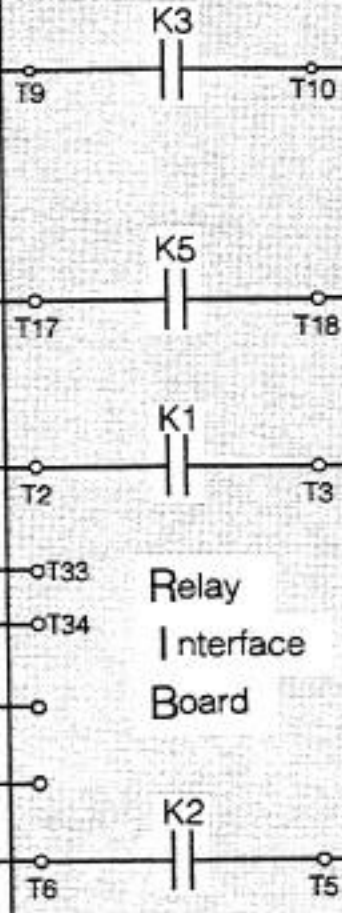

K3

K5

K1

K2

Hi Fire