



Visit [www.clevelandrange.com](http://www.clevelandrange.com) to locate a service or sales representative in your area.

# Cleveland

## Gas Vertical

# Mixer Kettles – Potentiometer Control

## Installation, Operation & Maintenance Manual

This manual is updated as new information and models are released. Visit our website for the latest manual.

### MODELS:

- MKGL-40-T
- MKGL-60-T
- MKGL-80-T

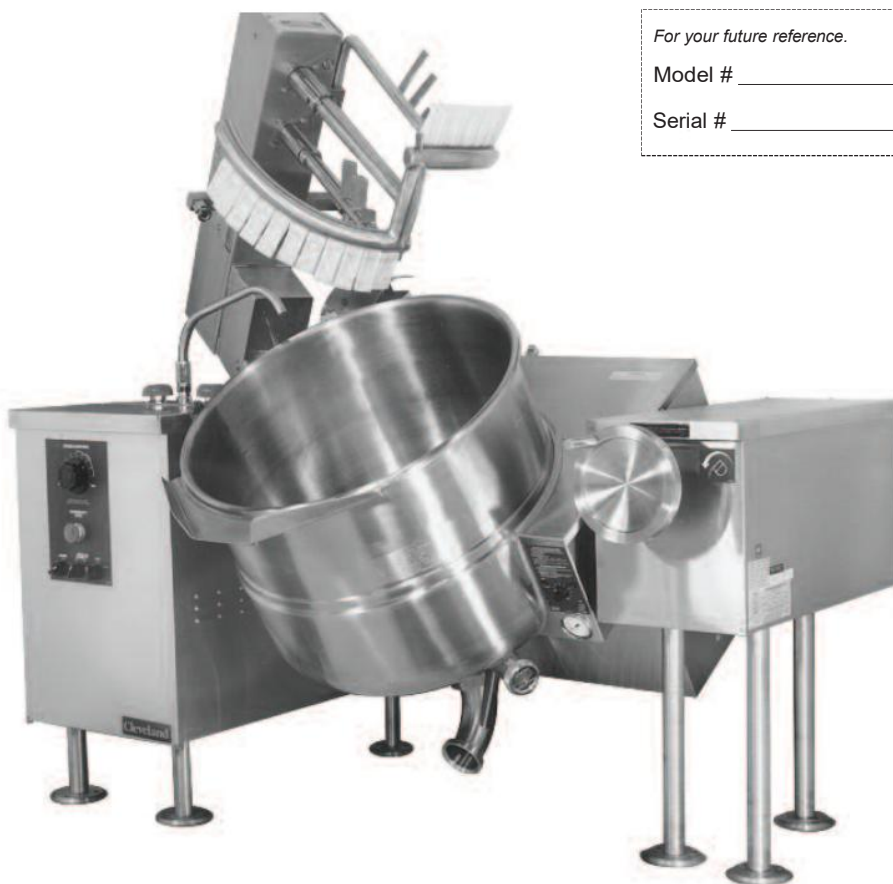

*For your future reference.*

Model # \_\_\_\_\_

Serial # \_\_\_\_\_



***Read the manual thoroughly. Improper installation, operation or maintenance can cause property damage, injury, or death.***

Part # KE004006-2 Rev C  
November 2025

# TABLE OF CONTENTS

<b>STATEMENT OF RESPONSIBILITIES .....</b>	<b>3</b>
<b>FOR YOUR SAFETY .....</b>	<b>5</b>
<b>INSTALLATION .....</b>	<b>9</b>
GENERAL .....	9
RECEIVING INSPECTION .....	9
SHIPPING DAMAGE INSTRUCTIONS .....	9
UNCRATING .....	9
VENTILATION .....	9
COMPRESSED AIR CONNECTION .....	9
POSITIONING .....	10
MOVING UNIT .....	10
LEVELING .....	10
GAS .....	11
ELECTRICAL .....	11
FOR POWER TILT UNITS ONLY .....	11
CLEANING .....	11
INSTALLATION CHECKS .....	12
TRANSFORMER TAPPING ADJUSTMENT INSTRUCTIONS .....	13
<b>OPERATING INSTRUCTIONS .....</b>	<b>15</b>
OPERATING CONTROLS AND INDICATORS .....	15
OPERATING THE KETTLE .....	17
<b>CLEANING INSTRUCTIONS .....</b>	<b>19</b>
<b>PREVENTATIVE MAINTENANCE .....</b>	<b>20</b>
DAILY PRE-STARTUP INSPECTION .....	20
SIX MONTH SERVICE INSPECTION .....	20
YEARLY SERVICE INSPECTION .....	20
<b>TROUBLESHOOTING AND MAINTENANCE PROCEDURES .....</b>	<b>21</b>
MECHANICAL CHECKS .....	21
TROUBLESHOOTING GUIDES .....	22
KETTLE SAFETY INSPECTION AND TESTING .....	26
KETTLE JACKET CLEANOUT AND PASSIVATION PROCEDURES .....	29

# **STATEMENT OF RESPONSIBILITIES / DÉCLARATION DES RESPONSABILITÉS / DECLARACIÓN DE RESPONSABILIDADES**

This document is for use by experienced and trained Qualified Cleveland Range, LLC Authorized Service Representatives who are familiar with both the safety procedures, and equipment they service. Cleveland Range, LLC assumes no liability for any death, injury, equipment damage, or property damage resulting from use of, improper use of, or failure to use the information contained in this document. Cleveland Range, LLC has made every effort to provide accurate information in this document, but cannot guarantee that this document does not contain unintentional errors and omissions.

The information in this document may be subject to technical and technological changes, revisions, or updates. Cleveland Range, LLC assumes no liability or responsibility regarding errata, changes, revisions, or updates.

Qualified Cleveland Range, LLC Authorized Service Representatives are obligated to follow industry standard safety procedures, including, but not limited to, OSHA regulations, and disconnect / lock out / tag out procedures for all utilities including steam, and disconnect / lock out / tag out procedures for gas, electric, and steam powered equipment and / or appliances.

All utilities (gas, electric, water and steam) should be turned OFF to the equipment and locked out of operation according to OSHA approved practices during any servicing of Cleveland Range equipment.

Qualified Cleveland Range, LLC Authorized Service Representatives are obligated to maintain up-to-date knowledge, skills, materials and equipment.

Ce document est destiné à l'usage des Représentants de Service qualifiés et autorisés de Cleveland Range, LLC qui possèdent l'expérience et la formation ainsi que la bonne connaissance des mesures de sécurité et du matériel qu'ils entretiennent.

Cleveland Range, LLC décline toute responsabilité pour tout cas de décès, blessure, dommage matériel ou dommage aux biens résultant de l'utilisation, de la mauvaise utilisation ou du manquement d'utilisation des renseignements contenus dans ce document.

Cleveland Range, LLC s'est efforcé à fournir des renseignements précis dans ce document mais ne peut garantir que ce document soit exempt d'erreurs et d'omissions non intentionnelles.

Les renseignements contenus dans ce document peuvent être assujettis à des changements techniques et technologiques, des révisions ou des mises à jour.

Cleveland Range, LLC décline toute obligation ou responsabilité concernant les errata, modifications, révisions ou mises à jour.

Les Représentants de Service qualifiés et autorisés de Cleveland Range, LLC sont tenus de se conformer aux mesures de sécurité normalisées de l'industrie, y compris, mais sans s'y limiter, les réglementations de l'OSHA, les procédures de débranchement / verrouillage / étiquetage relatives à tous les services publics, dont l'approvisionnement en vapeur, et les procédures de débranchement / verrouillage / étiquetage relatives aux équipements et/ou appareils fonctionnant au gaz, à l'électricité et à la vapeur.

Au cours de tout entretien d'un appareil Cleveland Range, tous les services publics (gaz, électricité, eau et vapeur) doivent être FERMÉS au niveau de l'appareil et le dispositif de fonctionnement doit être verrouillé suivant les pratiques approuvées de l'OSHA.

Les Représentants de Service qualifiés et autorisés de Cleveland Range, LLC sont tenus d'actualiser en permanence leurs connaissances, compétences, matériel et équipement.

Este documento está destinado para el uso de los Representantes de Servicio calificados y autorizados de Cleveland Range, LLC quienes cuentan con la experiencia y la capacitación así como el buen conocimiento de las medidas de seguridad y de los equipos que mantienen.

Cleveland Range, LLC, declina toda responsabilidad en caso de cualquier fallecimiento, lesiones, daños al equipo o daños a la propiedad resultantes de la utilización, del uso indebido o de la falta de utilización de la información provista en este documento.

Cleveland Range, LLC se ha esforzado en suministrar información precisa en este documento, pero no puede garantizar que este documento esté exento de errores y de omisiones no intencionales.

La información contenida en este documento podría estar sujeta a cambios técnicos o tecnológicos, revisiones o actualizaciones. Cleveland Range, LLC declina toda obligación o responsabilidad con respecto a erratas, modificaciones, revisiones o actualizaciones.

Los Representantes de Servicio calificados y autorizados de Cleveland Range, LLC tienen la obligación de seguir los procedimientos estándar de seguridad de la industria; los cuales incluyen pero no se limitan a los reglamentos de la OSHA (La Administración de la Seguridad y Salud Ocupacionales), los procedimientos de desconexión, cierre y etiquetado relativos a todos los servicios públicos incluyendo el suministro de vapor y los procedimientos de desconexión, cierre y etiquetado para los equipos y/o aparatos que funcionan a base de gas, electricidad o vapor.

Cuando se esté dando servicio o mantenimiento a un aparato de Cleveland Range, todos los servicios públicos (gas, electricidad, agua y vapor) deben estar APAGADOS para el equipo en cuestión y se debe seguir el procedimiento de cierre de operaciones de acuerdo con las prácticas aprobadas por la OSHA.

Los Representantes de Servicio calificados y autorizados de Cleveland Range, LLC tienen la obligación de actualizar constantemente sus conocimientos, destrezas, materiales y equipamiento.

## ***WARRANTY DISCLAIMER***

Our Kettles, Mixers, Skillets, and Steamers are designed for commercial kitchen environments. To ensure optimal performance, longevity, and safety, the following conditions must be maintained:

- **Humidity & Moisture:** The equipment is designed to operate within standard commercial kitchen humidity levels of **40% to 65%** relative humidity. Prolonged exposure to humidity levels exceeding **65%** may compromise electrical components, cause condensation-related issues, and reduce equipment lifespan. Proper ventilation is essential to maintaining safe conditions.
- **Steam, Condensate & Water Exposure:** While the equipment can withstand occasional water splashes and steam exposure, direct and prolonged contact with high-pressure steam or continuous water spray may cause damage and void the warranty. Effective ventilation is required to manage steam buildup.
- **Ambient Temperature:** The recommended operating temperature range is **13°C (55°F) to 39°C (102°F)**. Exposure to temperatures beyond this range may impact performance, lead to malfunctions, or pose safety risks.
- **Ventilation Requirements:** Proper ventilation must be maintained to prevent excessive heat and humidity buildup, which can lead to overheating, reduced efficiency, and premature wear. Gas-fired equipment must only be installed under a ventilation hood in a room with adequate makeup air. Always consult local regulations to ensure compliance with ventilation standards.
- **Water Quality:** Follow Cleveland Range's water quality guidelines to ensure optimal equipment performance. Softening hard water reduces deposits, and filtration removes corrosive elements. Regular descaling, as recommended, prevents scale buildup. Consult a water treatment specialist and follow local regulations for proper management.
- **Installation and Preventive Maintenance:** Follow Cleveland Range's installation and preventive maintenance guidelines to ensure proper functioning and longevity of the units. Regular upkeep prevents issues and ensures optimal performance. Failure to follow the schedule may lead to reduced efficiency and breakdowns.
- **Drainage System:** Failure to follow Cleveland Range specifications may result in damage. Do not place a drain beneath the unit, as excessive moisture can shorten the lifespan of electrical and gas components, leading to potential malfunctions or hazards.

Failure to adhere to these conditions may result in decreased efficiency, equipment damage, or safety hazards and may void the manufacturer's warranty.

**FOR YOUR SAFETY / POUR VOTRE SÉCURITÉ /  
PARA SU SEGURIDAD**

**FOR YOUR SAFETY**

Do not store or use gasoline or any other flammable liquids and vapours in the vicinity of this or any other appliance.

**WARNING:** Improper installation, operation, adjustment, alteration, service or maintenance can cause property damage, injury or death. Read the installation and operating instructions thoroughly before installing, operating or servicing this equipment.

Do not spray aerosols in the vicinity of this appliance while it is in operation.

This appliance is not to be used by persons with reduced physical, sensory or mental capabilities, or lack of experience and knowledge, unless they have been given supervision or instruction concerning use of the appliance by a person responsible for their safety.

This appliance is not for use by children and they must be supervised not to play with it.

Retain this manual for your reference.

**POUR VOTRE SÉCURITÉ**

Ne pas entreposer ou utiliser d'essence ou d'autres liquides ou vapeurs inflammables à proximité de cet appareil ou de tout autre appareil.

**AVERTISSEMENT:** Toute mauvaise pratique en matière d'installation, de fonctionnement, de réglage, de modification, d'entretien ou de maintenance peut causer des dommages matériels, des blessures ou la mort. Lisez la totalité des instructions d'installation et d'utilisation avant d'installer, d'utiliser ou d'entretenir cet équipement.

Ne pas pulvériser des aérosols dans le voisinage de cet appareil alors qu'il est en fonctionnement.

Cet appareil ne doit pas être utilisé par des personnes dont les capacités physiques, sensorielles ou mentales sont réduites, ou des personnes dénuées d'expérience ou de connaissance, sauf si elles ont pu bénéficier, par l'intermédiaire d'une personne responsable de leur sécurité, d'une surveillance ou d'instructions préalables concernant l'utilisation de l'appareil.

Conservez ce manuel pour votre référence.

**PARA SU SEGURIDAD**

No guarde ni use gasolina o cualesquiera otros líquidos o vapores inflamables en las cercanías de éste o cualquier otro aparato.

















**ADVERTENCIA:** La indebida instalación, operación, ajuste, modificación, servicio o mantenimiento puede ocasionar daños a la propiedad, lesiones o muerte. Lea detenidamente las instrucciones de instalación y de operación antes de instalar, poner a funcionar o dar servicio a este equipo.





No pulverice aerosoles en las proximidades de este aparato mientras está en funcionamiento.

Este aparato no debe ser utilizado por personas con capacidades físicas, sensoriales o mentales reducidas, o que no tengan la experiencia y los conocimientos adecuados, a menos que estas personas hayan recibido supervisión e instrucciones en cuanto al uso del aparato por la persona responsable de la seguridad de ellas.

Guarde este manual para su referencia.

# WARNING / AVERTISSEMENT / ADVERTENCIA



	<p>Inspect unit daily for proper operation. / Inspecter le bloc quotidiennement pour garantir le fonctionnement normal. / Inspeccione diariamente el funcionamiento correcto de la unidad.</p>		<p>Stand clear of product discharge path when discharging hot product. / Se tenir loin du chemin de purge des produits lors de la purge des produits chauds. / Manténgase alejado de la trayectoria de descarga del producto al descargar producto caliente.</p>
	<p>Heavy. / Lourd. / Pesado Team or mechanical lift. / Levage en équipe ou mécanique. / Levantamiento en equipo o mecánico.</p>		<p>Surfaces may be extremely hot! Use protective equipment. / Les surfaces peuvent être extrêmement chaudes! Utiliser des équipements de protection. / ¡Las superficies pueden estar muy calientes! Utilice equipo protector.</p>
	<p>Keep clear of pressure discharge. / Se tenir hors de portée de la purge des soupapes de surpression. / Manténgase alejado de la descarga de presión.</p>		<p>Keep hands away from moving parts and pinch points. / Tenir les mains à l'abri des pièces mobiles et des angles. / Mantenga las manos lejos de las piezas móviles y los puntos de presión.</p>
	<p>Hot product and surfaces. / Produit et surfaces chaudes. / Producto y superficies calientes.  Do not touch. / Ne pas toucher. / No la toque.</p>		<p>Do not fill kettle above recommended level marked on outside of kettle. / Ne pas remplir le chaudron au-delà du niveau indiqué à l'extérieur. / No llene la marmita por encima del nivel recomendado marcado en la parte exterior de la marmita.</p>
	<p>Unit must be anchored as per manual. / Unité doit être ancrée selon les directives du manuel.</p>		<p>Opening the drain cock will lead to the outflow of the hot contents of the boiling pan. Wear protective equipment when discharging hot product. / L'ouverture du robinet de vidange entraînera l'écoulement du contenu chaud de la marmite. Porter des équipements de protection lors de la purge des produits chauds. / La apertura de la llave de drenaje provocará la salida del contenido caliente de la marmita. Utilice equipo protector al descargar producto caliente.</p>
	<p>Floor may become slippery from product spillage. / Déversement de produit peut causer de plancher à être glissant. / Derrame de producto puede causar piso a ser resbaladizo.</p>		<p>In case of emergency or breakdown, refer to "Emergency" in OPERATING THE KETTLE section. / En cas d'urgence ou de panne, reportez-vous à « Urgence » dans la section FONCTIONNEMENT DE LA BOUILLIÈRE. / En caso de emergencia o avería, consulte "Emergencia" en la sección FUNCIONAMIENTO DEL HERVIDOR.</p>
	<p>Do not lean on or place objects on kettle lip. / Ne pas adosser ou placer des objets contre le bord de chaudron. / No se apoye en la tapa de la marmita ni coloque objetos sobre ella.</p>		<p>Do not remove guards or operate without them. / Ne pas supprimer les gardes ou fonctionner sans eux. / No retire los guardias ni funcionar sin ellos.</p>
	<p>Do not climb, sit or stand on equipment. / Il ne faut pas monter, s'asseoir ni se tenir debout sur l'équipement. / No subirse, ni sentarse ni pararse sobre el equipo.</p>		<p>Have a qualified service technician maintain your equipment. / Demandez à un technicien en entretien et en réparation qualifié d'effectuer l'entretien de votre équipement. / Haga que un técnico de servicio calificado mantenga su equipo.</p>

	Keep appliance and area free and clear of combustibles. / Gardez l'appareil et son entourage libre de tous combustibles. / Mantenga el aparato y el área libres de combustibles.		Do not attempt to operate this appliance during a power failure. / N'essayez pas de faire fonctionner cet appareil lors d'une panne de courant. / No intente poner en marcha este aparato durante un fallo de suministro eléctrico.
	Shut off power at main fuse disconnect prior to servicing. / Couper l'alimentation sur le principal fusible sectionneur avant l'entretien. / Apague la alimentación eléctrica en el fusible desconectador principal antes de darle servicio.		Ensure kettle is at room temperature and pressure gauge is showing zero or less prior to removing any fittings. / S'assurer que le chaudron se trouve dans une température ambiante et que le manomètre affiche zéro ou moins avant de déposer les raccords. / Asegúrese de que la marmita está a temperatura ambiente y el manómetro está mostrando cero o menos antes de quitar cualquier accesorio.
	Unit exhaust contains carbon monoxide. Operate only under a properly functioning hood with adequate makeup air. / L'échappement de l'unité émet du monoxyde de carbone. Exploiter uniquement sous une hotte fonctionnant correctement avec une source adéquate d'air d'appoint. / El escape de la unidad contiene monóxido de carbono. Operar solamente bajo una campana en buen funcionamiento con aire de relleno adecuado.		

**POWER SUPPLY / SOURCE DE COURANT / FUENTE DE ALIMENTACIÓN**

	Appliance must <u>not</u> be supplied through an external switching device that is regularly switched on and off. / L'appareil ne doit pas être alimenté par un interrupteur externe régulièrement allumé et éteint. / El aparato no debe ser alimentado a través de un dispositivo de conmutación externo que se encienda y apague periódicamente.
---	---

**MAINTENANCE / ENTRETIEN / MANTENIMIENTO**

	The pressure relief valve must be inspected every six months. / La soupape de décharge doit être inspectée à tous les six mois. / La válvula de descarga de presión debe ser inspeccionada cada seis meses.  Have a qualified service technician inspect your unit yearly. / L'unité doit être inspectée annuellement par un technicien de service qualifié.
	Greasing must be performed every six months, as outlined in the maintenance procedures, to prevent wear or damage. / La lubrification doit être effectuée tous les six mois, conformément aux procédures de maintenance, afin d'éviter l'usure ou les dommages. / La lubricación debe realizarse cada seis meses, según los procedimientos de mantenimiento, para evitar el desgaste o los daños.

# ***NOTICE***

## **FOR THE USER**

Read the Operating instructions thoroughly before using this equipment.

## **FOR THE INSTALLER**

Read the Installation instructions thoroughly before installing or servicing this equipment.

Improper installation, adjustment, alteration, service or maintenance can cause property damage, injury or death.

This appliance is not to be used by persons with reduced physical, sensory or mental capabilities, or lack of experience and knowledge, unless they have been given supervision or instruction concerning use of the appliance by a person responsible for their safety.

This appliance is not for use by children, and they must be supervised not to play with it.

Any repairs to the pressure vessel must be done by a certified pressure vessel repair shop and all repair methods and materials must be approved by the manufacturer.

## **MODEL NUMBER LEGEND:**

<b>1</b>	<b>2</b>	<b>3</b>	<b>-</b>	<b>4</b>	<b>-</b>	<b>5</b>
----------	----------	----------	----------	----------	----------	----------

<b>1 – Type of Equipment</b>	<b>2 – Type of Power</b>	<b>3 – Type of Mount</b>	<b>4 – Designation of Capacity in Gallon</b>	<b>5 – Tilting Options</b>
MK = Mixer Kettle TMK = Twin Mixer Kettle	E = Electricity G = Gas D = Direct Steam	L = Legs or Frame M = Modular (Cabinetized) T = Table Top	From 3 Gallon to 200 Gallon	Blank = Stationary T = Tilting

# INSTALLATION

## GENERAL

### Environment:

Operating Criteria	Acceptable Range
Ambient Air Temperature	15-40 degrees Celsius
Relative Humidity	0-80%
Altitude	0-3000 meters
Location	Inside building, under ventilation hood

Ensure electrical supplies match rating plate. Installation of the kettle must be accomplished by qualified installation personnel working to all applicable local and national codes.

This equipment is built to comply with applicable standards for manufacturers. Included among those approval agencies are: UL, NSF, ASME/N.BD., CSA, ETL, and others. Many local codes exist, and it is the responsibility of the owner/installer to comply with these codes.

Observe all clearance requirements. Do not obstruct the flow of combustion and ventilation air.

## RECEIVING INSPECTION

Before unpacking visually inspect the unit for evidence of damage during shipping.

If damage is noticed, do not unpack the unit, follow shipping damage instructions.

## SHIPPING DAMAGE INSTRUCTIONS

If shipping damage to the unit is discovered or suspected, observe the following guidelines in preparing a shipping damage claim.

1. Write down a description of the damage or the reason for suspecting damage as soon as it is discovered. This will help in filling out the claim forms later.
2. As soon as damage is discovered or suspected, notify the carrier that delivered the shipment.
3. Arrange for the carrier's representative to examine the damage.
4. Fill out all carrier claims forms and have the examining carrier sign and date each form.

### APPROXIMATE WEIGHTS

Model #	Unit	Unit with shipping box
MKGL-40-T	780 lbs.	850 lbs.
MKGL-60-T	855 lbs.	925 lbs.
MKGL-80-T	930 lbs.	1,000 lbs.

## UNCRATING

### Caution:

Straps under tension and will snap when cut.

Carton may contain staples and skid contains nails.

Use proper safety equipment and precautions.

Unit is heavy use adequate help or lifting equipment as needed.



1. Carefully cut any straps from container
2. Lift off carton.
3. Inspect for hidden damage. If found refer to "SHIPPING DAMAGE INSTRUCTIONS".
4. Cut strap holding unit.
5. Remove lag bolts from feet.
6. Remove manual from kettle pot. Write down the model# and serial# of the unit onto the front of this manual.
7. Lift kettle off skid and move kettle to its installation location.
8. Discard packaging material according to local and or state requirements.



Model/  
Serial#



## VENTILATION

Gas fired kettles are only to be installed under a ventilation hood in a room which has provisions for adequate make up air.

Further information can be obtained by referring to the U.S.A. National Fire Protection Associations NFPA96 regulations. These standards have also been adopted by the National Building Code in Canada.

Operation of these units can produce significant levels of steam and condensate, it is recommended they be installed under a ventilation hood in a room which has provisions for adequate make up air. Further information can be obtained by referring to the U.S.A. National Fire Protection Associations NFPA96 regulations. These standards have also been adopted by the National Building Code in Canada.

## COMPRESSED AIR CONNECTION

Mixer Kettles with an air activated discharge valve require a minimum of 90 PSI to operate correctly.

If the unit is also supplying air to a Metering Filling Station then a pressure of 100 PSI at a minimum volume of 25 CFM is required.

The air supplied to the mixer should be clean and dry. No oil should be added to the supply air. We recommend the compressed air system be equipped with a drier, filter, and automatic water dump on the air compressor receiver tank. If the distance between the tank and the unit is less than 100 feet then a minimum line size of 3/4" is required. A distance of 100 to 300 feet requires a minimum 1" line.



## POSITIONING

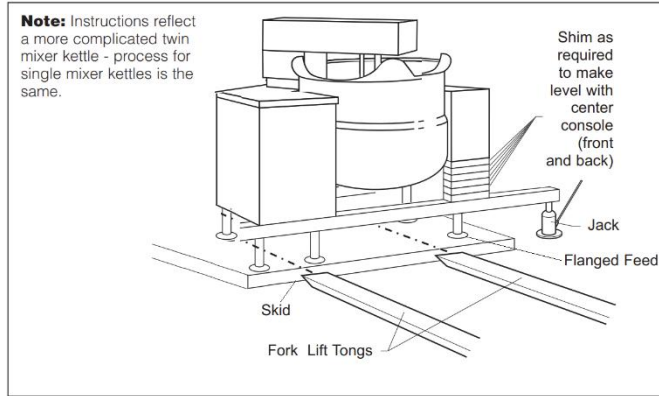

## MOVING UNIT

1. While still on skid, move unit as close to final installation position as possible.
2. Prepare unit for lifting as shown in diagram.
3. Lift gently with a forklift or jacks and remove skid.
4. Lower gently to ground and remove forklift and blocking.
5. If unit has to be re-positioned, slide gently. Do not twist or push one side of unit excessively and cause binding on trunnions.

## LEVELING

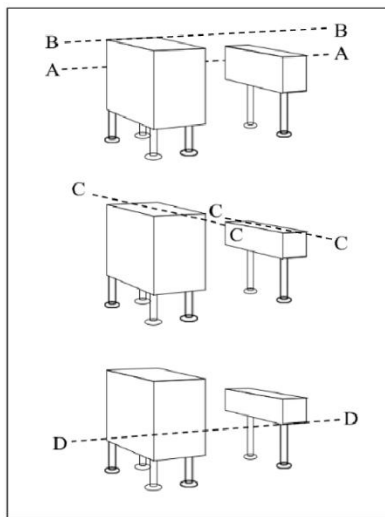

1. With straight-edge, line the backs of the consoles up with each other (dotted line **A**).
2. Adjust the heights according to the table below (dotted line **B**). Adjustments are made by turning flanges on back feet only.
3. Level consoles individually from front to back (dotted lines **C**). Adjustments are made by turning flanges on front feet only.
4. Re-check the height difference at the back (dotted line **B**) and the front (dotted line **D**) of the consoles as specified in the table below. Adjust if necessary.

Model #	Console – Console Height Difference
MKGL-40-T	3/16"
MKGL-60-T	2 3/16"
MKGL-80-T	2 11/16"

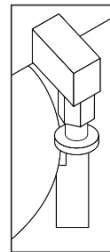

5. Check that mixer bridge is level and guide pins (see illustration) lock smoothly without binding. If not repeat steps **1** through **4**.

**NOTE:** See Operating Instructions before operating unit.

6. Make electrical connections (see electrical service connections) and test mixer bridge as follows:
  - A/** Raise mixer bridge: Move the bridge to its highest position.
  - B/** Swing bridge out over center console to far left and lower bridge.
  - C/** Bridge pins should enter pin hole on kettle perfectly. If not return to step 1 and repeat levelling steps.

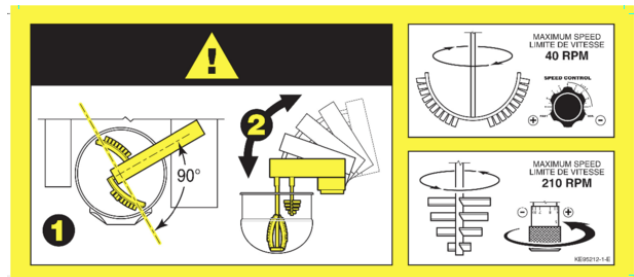

- D/** Raise bridge and swing to far right (for twin mixers only).
  - E/** Repeat steps B and C (for twin mixers only).
7. Once positioned and levelled, permanently secure the kettle's flanged feet to the floor using stainless steel lag bolts and floor anchors (supplied by the installer). Secure each of the flanged feet with one bolt in each hole. Seal joints of flanged feet with a silicone sealant.

### ADDITIONAL TIPS:

- Verify that the hydraulic hoses are free from pinching and properly routed during movement of the arm.
- On twin mixer models, repeat all bridging and alignment checks for both sides.
- Ensure all electrical connections and safety systems are correctly installed before final operation.

## GAS

### **ENSURE THE GAS SUPPLY MATCHES THE KETTLE'S REQUIREMENTS AS STATED ON THE RATING PLATE.**

Installation must conform, with local codes or in the absence of local codes, with the National Fuel Gas Code ANSI Z223.1/NFPA 54, or the Natural Gas and Propane Installation Code, CSA B149.1.

The appliance and its individual shut-off valve must be disconnected from the gas supply piping system during any pressure testing of that system at test pressures in excess of 1/2 psi (3.45 kPa).

The appliance must be isolated from the gas supply piping system by closing its individual manual shut-off valve during any pressure testing of the gas supply piping system at test pressures equal to or less than 1/2 psi (3.45 kPa).

It is recommended that a sediment trap (drip leg) be installed in the gas supply line. If the gas pressure exceeds 1/2 psi (3.45 kPa) water column, a pressure regulator must be installed, to provide a maximum of 1/2 psi (3.45 kPa) water column gas pressure to the gas control valve.

Use a gas pipe joint compound which is resistant to L.P. gas. Test all pipe joints for leaks.

1. Removed supplied manual shut-off valve and establish mounting location.
2. Add union and piping as required.
3. Connect the gas line to the manual shut-off valve.

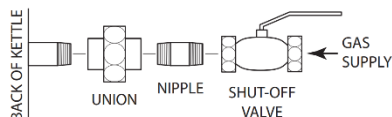

## ELECTRICAL

### **ENSURE THE ELECTRICAL SUPPLY MATCHES THE KETTLE'S REQUIREMENTS AS STATED ON THE RATING LABEL.**

Install in accordance with local codes and/or the National Electric Code ANSI/NFPA No 70-1981 (USA) or the Canadian Electric Code CSA Standard C22.1 (Canada). A separate fused disconnect switch must be supplied and installed. The kettle must be electrically grounded by the installer.

**NOTE:** This appliance is not GFI (GFCI) compatible.

The electric supply must match the power requirements specified on the kettle's rating plate. The copper wiring must be adequate to carry the required current at the rated voltage. Refer to the specification sheet for electrical specifications.

1. Ensure main power is turned off before connecting wires.
2. Remove the screws at the rear of the center console cover, and remove the cover. A wiring diagram is affixed to the underside of the console cover.
3. Feed permanent copper wiring 18" through the cut-out in the bottom of the console. Connect wiring in junction box in the bottom of the console.
4. Turn main power back on.

5. Check for correct rotation of electric motor (access by removing top front cover on center console). If rotation is incorrect, disconnect main power and reverse any two of the three live lines.
6. Replace the console cover and secure it with screws.

## FOR POWER TILT UNITS ONLY

NOTE: Ensure the electrical supply matches the kettle's requirements as stated on the rating label.

This kettle is built to comply with CE standards. Many local codes exist, and it is the responsibility of the owner and installer to comply with these codes.

## CLEANING

After installation the kettle must be thoroughly cleaned and sanitized prior to cooking.

## INSTALLATION CHECKS

Although the kettle has been thoroughly tested before leaving the factory, the installer is responsible for ensuring the proper operation of kettle once installed.

1. Before turning the kettle on, read the vacuum/pressure gauge. The gauge's needle should be in the green zone. If the needle is in the "VENT AIR" zone, follow air venting procedure.
2. Unit has been thoroughly checked for gas leaks at the factory however the installer should check all connections for any leaks which may have resulted from shipping or installation.
3. Supply power to the kettle by placing the fused disconnect switch to the "ON" position.
4. Open gas shut-off valve to turn on main gas supply.
5. Turn the temperature control knob to "1" (Min.). The green LED light should remain lit, indicating the burner is lit, until the set temperature is reached. Then the green light will cycle on and off, indicating the burner is cycling on and off to maintain temperature.
6. Tilt the kettle forward. After a few seconds the red "LOW WATER" light should be lit when the kettle is in a tilted position. This light indicates that the burner has automatically been shut off by the kettle's safety circuit. This is a normal condition when the kettle is in a tilted position.
7. Raise the kettle to the upright position. The red "LOW WATER" light should go out when the kettle is upright.
8. Turn the temperature control knob to "10" (Max.) and allow the kettle to preheat. The green light should remain on until the set temperature is reached. Then the green light will cycle ON and OFF, indicating the burner is cycling ON and OFF to maintain temperature.
9. Check carbon monoxide is less than 0.08 percent in an air-free sample of the flue gases. See FREE AIR CALCULATION procedure in "Maintenance Procedures & Parts Lists" manual.

## MIXER

1. Raise Bridge - If bridge does not raise then check motor rotation. Bridge should not raise until speed control is turned to minimum and then adjusted back up.
2. Swing Bridge - Bridge when fully raised should swing without hitting any object, i.e. control housing, kettle lip. Check that hydraulic hoses are not being pinched by stops on swivel assembly.
3. Tilt Kettle - Kettle tilts smoothly both down and back up. If power tilt, check that micro switches are adjusted properly (kettle is level in upright position and drains fully when tilted) and are not being crushed by gear.
4. Lower Bridge - Raise bridge. Switch to mix. Turn speed control to zero to reset micro switch then set speed control to number four. Check that unit does not begin to mix until bridge has lowered part way into the kettle. Check that mixer bridge pin lowers into pin hole correctly
5. Speed Control - Main - Main agitator arm not rotating when set at "0" but will start to move slowly on "1". Speed control makes positive contact with micro switch.

6. Speed Control - Secondary- Set main speed control to five. Adjust secondary control from minimum to maximum. Look for considerable speed variance.

7. Water Faucets - Turn on hot water faucet. Turn off and check for leaks in piping and drips from faucet spout. Repeat above with cold water faucet.

8. Product Discharge - Add water to kettle. Check for leaks from valve. Open and close valve a few times and check for leaks again.

# Instruction Manual

---

## **Transformer Tapping Adjustment Instructions for 208-240V Range**

### Factory configuration

- Unit is factory-configured for **208V** operation.
- 

### When to adjust

If the supply voltage is **240V**, the transformer tapping must be changed to ensure performance.

---

### Procedure

#### 1. Turn Off Power

- Disconnect power supply to the unit before performing any adjustments.

#### 2. Locate the Front operating panel



#### 3. Open the panel and locate the transformer.



4. Identify the tapping selector on the transformer.



5. Current position: Tap 3 (208V)



- Required position: **Tap 4 (230V)**

6. Move the connection from position 3 → position 4.

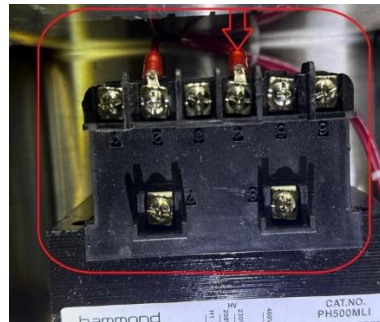

7. Verify connection

- Ensure all connections are secure.
- Close the inverter housing properly.

8. Restore power

- Reconnect supply voltage.
- Confirm unit operation 240V supply.

**⚠ Attention**

**The unit is configured for 208V. Verify supply voltage is 208V.  
If supply is 240V, tap transformer to 240V.**

-KE605282

## **WARNING**



If for any reason this unit is not functioning correctly DO NOT OPERATE. Contact your authorized service agent.

# **OPERATING INSTRUCTIONS**



## **OPERATING CONTROLS AND INDICATORS**



- A.  **LOW WATER INDICATOR LIGHT (RED)**  
When lit, indicates that the kettle is low on water and will not operate in this condition. This will also light when the kettle is tilted.
- B.  **ON-OFF SWITCH/SOLID STATE TEMPERATURE CONTROL**  
Turns kettle ON/OFF and allows the operator to adjust the kettle temperature in increments from 1 (Min.) to 10 (Max.).
- C. **HEAT INDICATOR LIGHT (GREEN)**  
When lit, indicates that the kettle's burner is on. Cycles ON-OFF with burner.
- D. **VACUUM/PRESSURE GAUGE**  
Indicate steam pressure in PSI inside steam jacket as well as vacuum in inches of mercury.
- 1. **MAIN POWER SWITCH**  
Power switch for unit.
- 2. **MIX/LIFT SWITCH**  
Sets hydraulics to mix or lift mode.
- 3. **UP/DOWN SWITCH**  
When unit is in lift mode, mixer bridge can be raised or lowered with this switch.
- 4. **MIXER SPEED CONTROL**  
Controls speed of agitators and mixer bridge lift.
- 5. **EMERGENCY STOP BUTTON**  
Stops hydraulic system (agitators and mixer bridge lift).
- 8. **ACTIVE/BYPASS SWITCH**  
Switch to activate or bypass (manual operation) the controller.
- 9. **TEMPERATURE CONTROLLER**  
Digital temperature control and indicator.
- 10. **WATER METER POWER SWITCH**  
Power switch for water meter.
- 11. **WATER METER START SWITCH**  
Starts water flow to kettle.
- 12. **WATER METER INTERRUPT SWITCH**  
Interrupts flow without resetting water meter.
- 13. **WATER METER CONTROL**  
Display and settings for water meter.
- 14. **TIME/TEMPERATURE CHART RECORDER**  
Documents cooking information.

## OPERATING CONTROLS AND INDICATORS (CONTINUED)



- |   |  |
|---|--|
| <p>15. MIXER BRIDGE<br/><u>Encloses agitator motors.</u></p>  | <p>22. PRESSURE RELIEF VALVE (NOT SHOWN)<br/>This valve is used to vent the kettle and in the unlikely event there is an excess steam build-up in the jacket, this valve opens automatically to relieve this pressure.</p> |
| <p>16. MAIN AGITATOR ARM<br/><u>Provides most of the product movement.</u></p>                      | <p>23. HAND TILT WHEEL<br/>Used for tilting the kettle up or down. Replaced by switch on power tilt units.</p>   |
| <p>17. SECONDARY AGITATOR ARM<br/><u>Provides reverse agitation and product lift in kettle.</u></p> | <p>24. BUTTERFLY VALVE<br/><u>Discharge valve for product in the kettle.</u></p>   |
| <p>18. SECONDARY SPEED CONTROL KNOB<br/><u>Controls speed of secondary agitator arm.</u></p>        | <p>25. WATER LEVEL SIGHT GLASS<br/><u>Displays water level in steam jacket.</u></p>  |
| <p>19. FAUCET SPOUT<br/><u>Delivers water to the kettle.</u></p>                                    | <p>26. AIR REGULATOR SWITCH<br/>Used to open and close the air valve (optional/not shown).</p>   |
| <p>20. HOT WATER VALVE<br/><u>Turns on hot water.</u></p>   |  |
| <p>21. COLD WATER VALVE<br/><u>Turns on cold water.</u></p>   |  |

# OPERATING THE KETTLE



## Intended Use:

Processing of food and pharmaceuticals in non-residential locations. Not for the making of dough or other heavy dough like products.

## Intended Users:

- Supervised and trained staff during production periods.
- Trained maintenance and service personnel.

## Removable component weights

Lbs (kg)	40 gal	60 gal	80 gal	100 gal	125 gal	150 gal
Main arm with blades	21 (9.5)	23 (10.4)	25 (11.3)	28 (12.7)	32 (14.5)	32 (14.5)
Baffle arm	7 (3.2)	7 (3.2)	8 (3.6)	10 (4.5)	12 (5.4)	12 (5.4)
Secondary arm	8 (3.6)	8 (3.6)	10 (4.5)	12 (5.4)	13 (5.9)	13 (5.9)
Screen	7 (3.2)	8 (3.6)	9 (4.1)	10 (4.5)	14 (6.4)	14 (6.4)
Air valve complete			12 (5.4)			
Air cylinder only			8 (3.6)			
Air valve body only			4 (1.8)			

## Noise level

Noise level maximum 80 Decibels.

## Mixing Arm Rotation speeds

Arm	Speed (RPM)
Primary	0-40
Secondary	0-210

## Rim (loading) heights

Rim heights are given below. It is up to owners of the equipment to ensure the operators are performing the loading in a safe and acceptable manner.

Size	Height
40	40.5
60	43.75
80	44.75

## Emergency

In the event of a fire or other emergency.

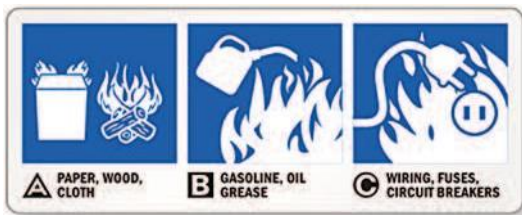

## Turn off unit

Shut off power supplies including Electrical, Gas or Steam as applicable. (If safe to do so.)

Using fire extinguishers is only recommended if you are trained and feel safe to do so. Use only Fire extinguishers rated ABC.

This is a pressure vessel and with a properly operating safety valve will not exceed rated pressures. Jacket contains water and trace amounts of rust inhibitor and/or antifreeze.

## WARNING:



This unit has been fitted with a warning buzzer for bridge movement and a cover and screen to prevent contact with moving mixer arms. Do not remove or bypass these safeties.

1. Perform daily startup inspection.
2. Preheat the kettle by turning the ON/OFF Temperature Control to the desired temperature setting. The Heat Indicator Light (Green) will remain lit, indicating the burner is on, until the temperature setting is reached. When the green light goes off, the burners are off, and preheating is complete.

**NOTE:** When cooking egg and milk products, the kettle should not be preheated, as products of this nature adhere to hot cooking surfaces.

3. Place food product into the kettle. The green Heat Indicator Light will cycle on and off indicating the burners are cycling on and off to maintain the set temperature.



4. When cooking is completed turn Temperature Control to the "OFF" position.
5. Pour the contents of the kettle into an appropriate container by tilting the kettle forward or using discharge valve.

**NOTE:** Cleaning should be completed immediately after cooked foods are removed.

**NOTE:** A five minute complete shut-off period is required before relighting.

## Operating Suggestions

Cleveland Range Mixer Kettles are simple and safe to operate. The following tips will allow you to maximize the use of your new mixer.

If a mixer bridge is equipped with a temperature probe for a controller or thermometer, the probe must be submerged a minimum of three inches in the product for accurate readings.

## Safety

As a safety precaution the MIXER SPEED CONTROL must first be turned to zero before unit will start to mix.

Always remember, like a cooking pot the kettles become very hot when cooking. Avoid contact with bare skin.

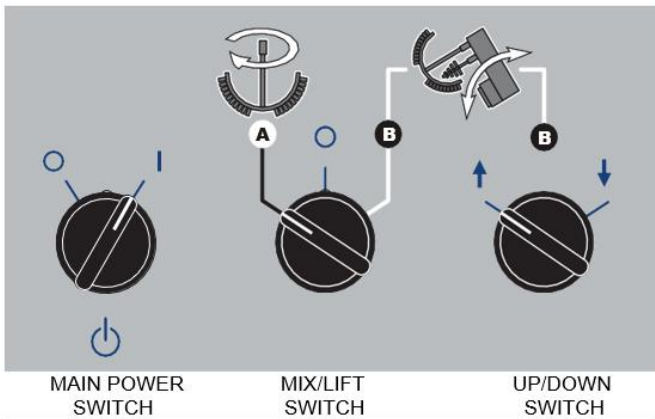

MAIN POWER SWITCH

MIX/LIFT SWITCH

UP/DOWN SWITCH

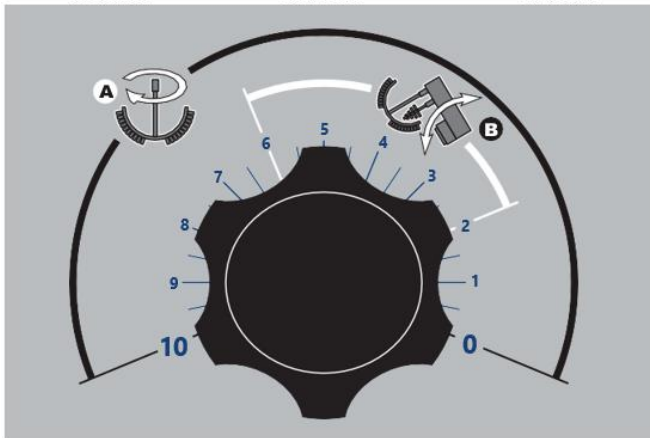

MIXER SPEED CONTROL SWITCH

## General Operation

1. Turn MAIN POWER SWITCH on.
2. Turn Steam Control Valve to control heat kettle.

## Lifting & Lowering Bridge

**WARNING:** Ensure FAUCET SPOUT is out of way before raising or lowering bridge.

1. Turn MIX/LIFT SWITCH to lift icon "B".
2. Turn MIXER SPEED CONTROL to "0" and back up to "5".
3. Turn and hold UP/DOWN SWITCH to up arrow to raise or down arrow to lower.

## Mixing

1. Turn MIX/LIFT SWITCH to mix icon "A".
2. Turn MIXER SPEED CONTROL SWITCH to "0" and slowly adjust to desired speed.
3. Adjust SECONDARY SPEED CONTROL KNOB to desired speed.

## Tilting Kettle

1. Raise MIXER BRIDGE and swing to side.
2. For manual tilt: Turn HANDWHEEL.
3. For power tilt: Turn POWER TILT CONTROL SWITCH.

**WARNING:** Do not tilt kettle when mixer agitators are in kettle bowl.

## Product Discharge Valve

1. For butterfly valve: Push handle in and pull upwards to open.
2. For air valve: Turn Air Regulator Switch to open or close.

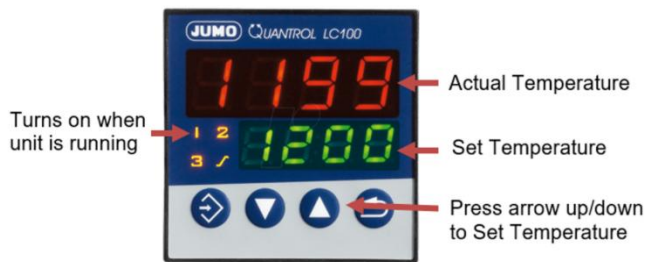

## Operation Using DTCI – JUMO LC100

**Note:** Temperature probe on mixer must be covered with a minimum of three inches of product to function correctly.



1. Turn mixer MAIN POWER switch to "ON" (JUMO LC100 lights up and displays present temperatures).



2. Turn HEAT/COOL switch to "OFF/AUTO".



3. Turn ACTIVE/BYPASS switch to "BYPASS". The unit should not be heating or cooling at this point.

4. To change set point temperature push ▲ or ▼ button.

5. Add product to kettle.



6. Turn ACTIVE/BYPASS switch to "ACTIVE". If the set point temperature is higher than the product temperature, the kettle will start heating.

## Note:

- For twin kettles, JUMO LC100 will control the kettle the mixer is in.

Button ◀ is for programming mode only. Press ▶ to exit programming mode.

# CLEANING INSTRUCTIONS



## CARE AND CLEANING

Cooking equipment must be cleaned regularly to maintain its fast, efficient cooking performance and to ensure its continued safe, reliable operation. The best time to clean is shortly after each use (allow unit to cool to a safe temperature).

## WARNINGS



Harsh Cleaners

Do not use harsh detergents or cleaners that are chloride-based, caustic, highly acidic, or contain quaternary salts.



Wire Brush & Scrapers

Do not use a metal bristle brush or scraper.



Steel Pads

Steel wool should never be used for cleaning the stainless steel.



High Pressure Spray Hose

Unit should never be cleaned with a high pressure spray hose.



Stagnant Water

Do not leave water sitting in unit when not in use.

## CLEANING INSTRUCTIONS

1. Turn unit off.
2. Remove drain screen (if applicable). Thoroughly wash and rinse the screen either in a sink or a dishwasher.
3. Prepare a warm water and mild detergent solution in the unit.
4. Remove food soil using a nylon brush.
5. Loosen food which is stuck by allowing it to soak at a low temperature setting.
6. Drain unit.
7. Rinse interior thoroughly.
8. If the unit is equipped with a **Tangent Draw-Off Valve**, clean as follows:
  - a) Disassemble the draw-off valve first by turning the valve knob counter-clockwise, then turning the large hex nut counter-clockwise until the valve stem is free of the valve body.
  - b) In a sink, wash and rinse the inside of the valve body using a nylon brush.
  - c) Use a nylon brush to clean tangent draw-off tube.
  - d) Rinse with fresh water.
  - e) Reassemble the draw-off valve by reversing the procedure for disassembly. The valve's hex nut should be hand tight only.
9. If the unit is equipped with a **Butterfly Valve**, clean as follows:
  - a) Place valve in open position.
  - b) Wash using a warm water and mild detergent solution.
  - c) Remove food deposits using a nylon brush.
  - d) Rinse with fresh water.
  - e) Leave valve open when unit is not in use.
10. If the unit is equipped with an **Air Valve**, clean as follows:
  - a) Open product valve.
  - b) Disconnect air hoses.
  - c) Remove air cylinder.
  - d) Remove valve tee.
  - e) Remove all O-rings.
  - f) Clean air cylinder, do not submerge in water. Wipe clean and sanitize.
  - g) Clean and sanitize tee and O-rings.
  - h) Grease and reinstall O-rings.
  - i) Reinstall valve tee to kettle outlet.
  - j) Reinstall air cylinder to bottom of tee.
  - k) Reconnect air hoses.
  - l) Close valve and check for alignment.
11. Clean the scraper blades as follows:
  - a) Remove retaining ring and slide scraper blades off agitator arm.
  - b) Place parts in a pan of warm water to soak.
  - c) Clean in a sink, using a warm water and mild detergent solution.
  - d) Rinse with fresh water.
  - e) Allow to dry thoroughly on a flat, clean surface.
12. Using mild soapy water and a damp sponge, wash the exterior, rinse, and dry.

## NOTES

- ⇒ For more difficult cleaning applications one of the following can be used: alcohol, baking soda, vinegar, or a solution of ammonia in water.
- ⇒ Leave the cover off when the kettle is not in use.
- ⇒ For more detailed instructions refer to Stainless Steel Equipment Care and Cleaning ([www.nafem.org/resources/stainlesssteelfinal.doc](http://www.nafem.org/resources/stainlesssteelfinal.doc)) on Nafem's website ([www.nafem.org](http://www.nafem.org)).

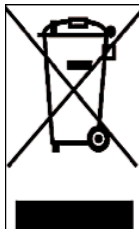

## DISPOSAL INSTRUCTIONS

This unit is recyclable. Do not dispose in landfill.

The unit may contain rust inhibitor and or antifreeze within the jacket. Drain unit and dispose following Federal, State and local regulations.

The majority of the unit is composed of stainless steel. Other alloys and electrical components make up a small percentage of the total. Follow Federal, state and local regulations for disposal.



# PREVENTATIVE MAINTENANCE

FOR MAINTENANCE AND REPAIRS CONTACT YOUR AUTHORIZED MANITOWOC SERVICE AGENCY AND HAVE A QUALIFIED SERVICE TECHNICIAN MAINTAIN YOUR EQUIPMENT.



## WARNING:

If for any reason this unit is not functioning correctly DO NOT OPERATE. Contact your authorized service agent.



## DAILY PRE-STARTUP INSPECTION

1. Flue (A) is not obstructed.
2. Product Discharge Valve (B) opens and closes.
3. Bridge (C) lifts up and screen is in place.
4. Pressure Gauge (D) is in the green when unit is cold.
5. Green Light (E) comes on when unit is energized.
6. Red Light (F) comes on when unit is tilted.
7. Red Light (F) comes on when unit is tilted.
8. All switches are functioning correctly.

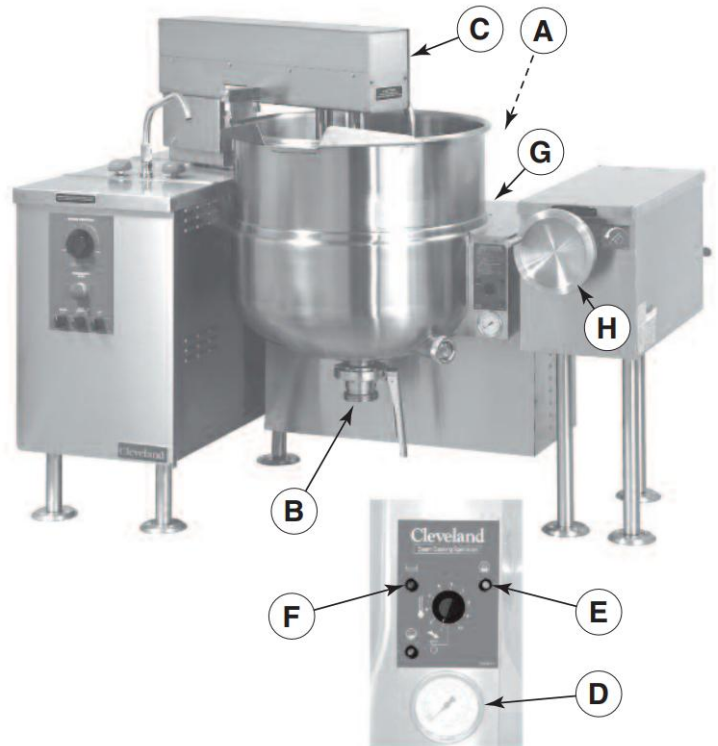

## SIX MONTH SERVICE INSPECTION

1. Perform daily startup inspection.
2. Gasket (G) around top cover is in good condition.
3. Tilt hand (H) wheel is tight.
4. **Grease bearings on both trunnions.**
5. Check for play in gears (adjust if required).
6. Fasteners securing panels are in place and tight.
7. **Perform pressure relief valve periodic test (see Pressure Relief Valve Testing).**
8. Adequate exhaust and makeup air is supplied to working area.
9. Check for hydraulic leaks.
10. Check safety systems have not been bypassed.

## YEARLY SERVICE INSPECTION

1. Perform six month service inspection.
2. Check kettle maximum temperature setting (see Calibrating Procedure).
3. Inspect safety thermostat for proper connections (see Safety Thermostat).
4. Inspect Low water probe for proper connections (see Low Water Level Probe).
5. Inspect safety valve installation (see SAFETY VALVE INSTALLATION).
6. Clean blower.
7. Perform free air calculation (see FREE AIR CALCULATION).
8. Replace hydraulic oil and filter.

# **TROUBLESHOOTING AND MAINTENANCE PROCEDURES**

*The following trouble shooting guide and maintenance procedures  
are meant to be used by Qualified Service Technician*



**ANY REPAIRS TO THE PRESSURE VESSEL MUST BE DONE BY A CERTIFIED  
PRESSURE VESSEL REPAIR SHOP AND ALL REPAIR METHODS AND MATERIALS  
MUST BE APPROVED BY THE MANUFACTURER.**

For periodic maintenance recommendations see “Operators Manual”.

**Extreme caution must be taken if unit is electrically energized for testing. Remove power  
from the unit while servicing.**

## **SPARE PARTS LIST**

<b>PART NO.</b>	<b>DESCRIPTION</b>	<b>QTY.</b>
KE51834	Scraper Blades.....	5
KE00860	Speed Control Cable Assembly .....	1
KE52936-6	Fuse, 3 Amp.....	2
KE50753-10	Relay.....	2-5
KE52936-16	Fuse .....	2
KE603208-9	Contact Block, Normally Open.....	2
KE603208-8	Contact Block, Normally Closed .....	2

## **MECHANICAL CHECKS**

- 1.** Inspect controls, replace damaged seals, switches, LED's, etc..
- 2.** Remove the console cover and check that the seal is not cracked or split. Replace seal, screws, missing or worn nylon anchor nuts. **Leave cover off.**
- 3.** Remove the kettle bottom cover and check that the seal is not cracked or split. **Leave cover off.**

### **4. For units with tilt crank-**

- A.** Check that the kettle tilts smoothly. If there is excess play adjust the worm to gear clearance with Locking Nuts or Adjusting Screw as required.
- B.** Check that there is no excessive wear in the trunnion bearings.
- C.** Apply grease to gear teeth and bearings.

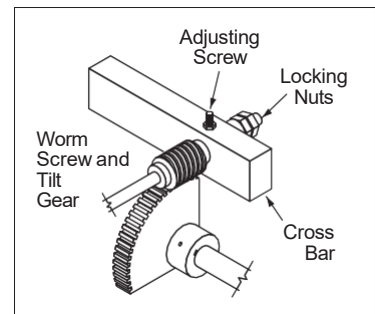

Illustration inverted for clarity.



Grease Nipples.

# TROUBLESHOOTING GUIDES (Legend)



5. Kettle Jacket Water Sight Glass



← 1. Green Light

← 2. Red Light

3. ON/OFF Switch

4. Potentiometer

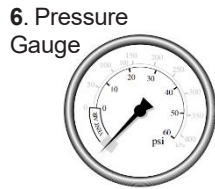

6. Pressure Gauge

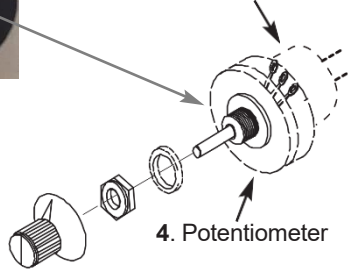

9. Water Level Probe

16. High Limit Tube

10. Thermistor

11. Ignitor

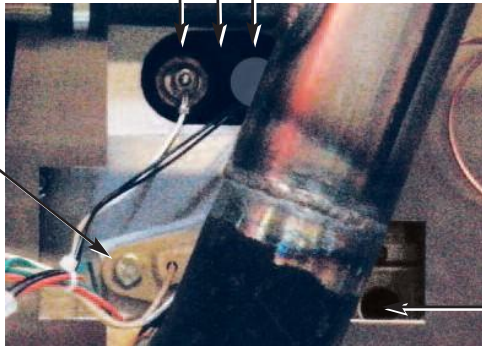

7. Gas Valve (showing hose for Pressure tap)



8. Blower

- 1. Green Light
- 2. Red Light
- 3. ON/OFF Switch
- 4. Potentiometer
- 5. Kettle Jacket Water Sight Glass
- 6. Pressure Gauge
- 7. Gas Valve
- 8. Blower
- 9. Water Level Probe

- 10. Thermistor
- 11. Ignitor
- 12. Sight Glass
- 13. 14V Transformer
- 14. 24V Ignition Transformer
- 15. SSK Controller
- 16. High Limit
- 17. Ignition Module
- 18. Relay
- 19. Air Switch

12. Flame Sight Glass

15. SSK Controller



13. 14V Transformer

14. 24V Ignition Transformer

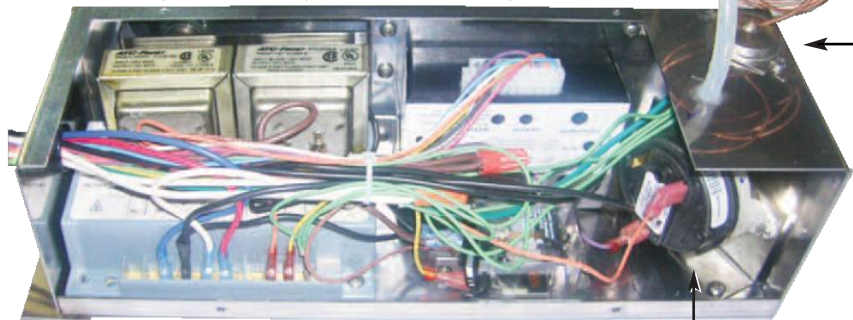

16. High Limit

17. Ignition Module

18. Relay

19. Air Switch

# TROUBLESHOOTING GUIDES (continued)

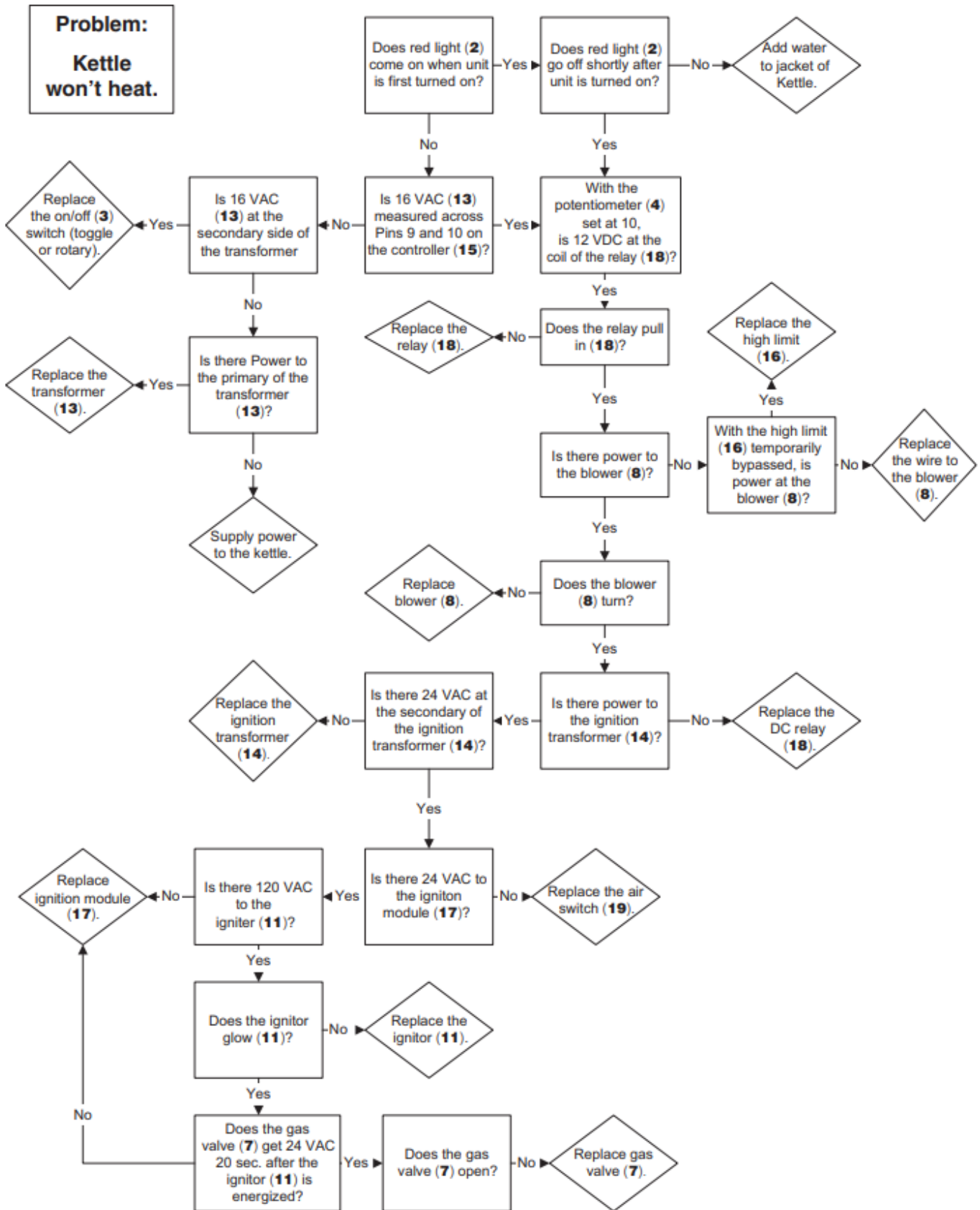

# TROUBLESHOOTING GUIDES (continued)

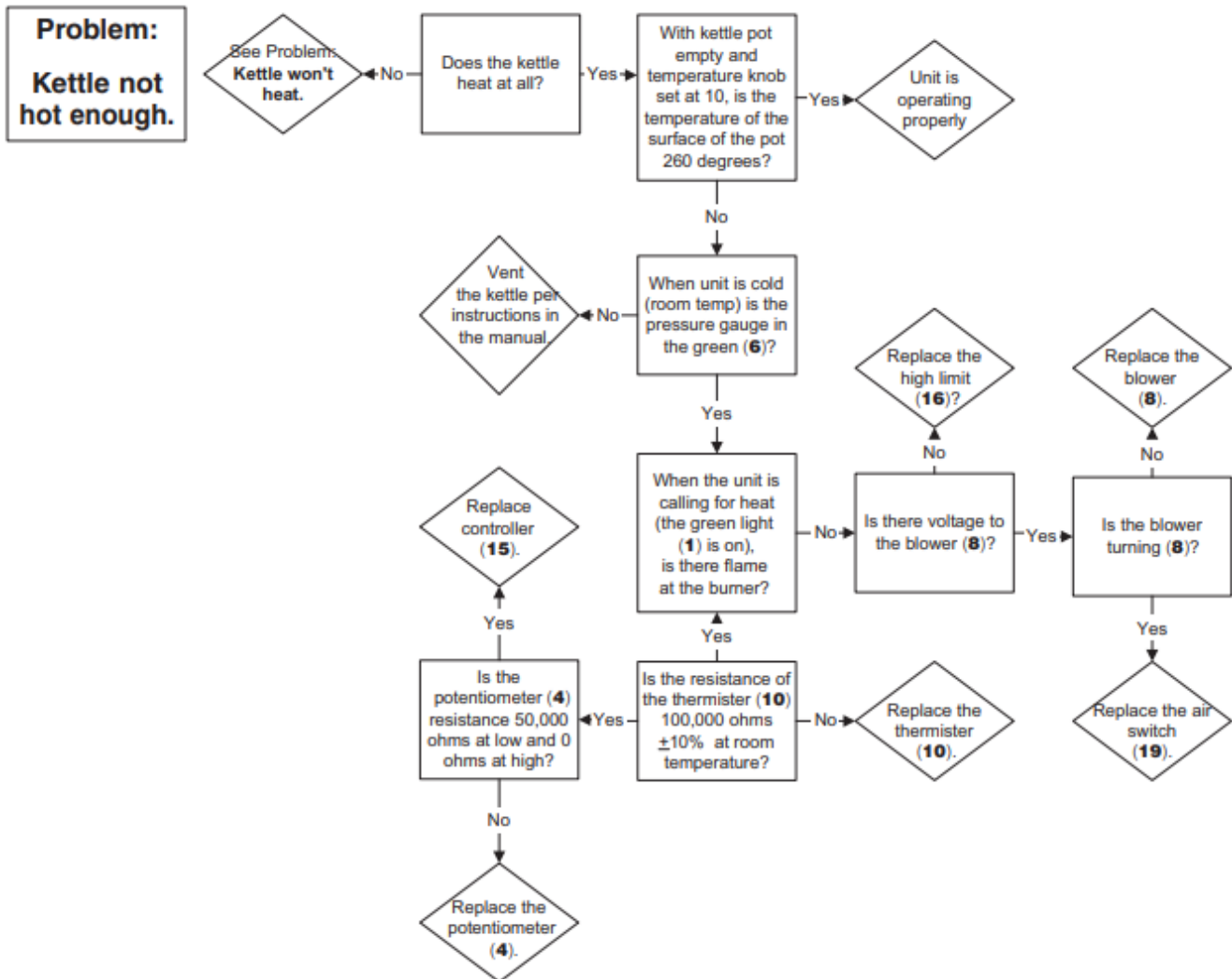

## PROBLEM: Kettle Has Delayed Ignition

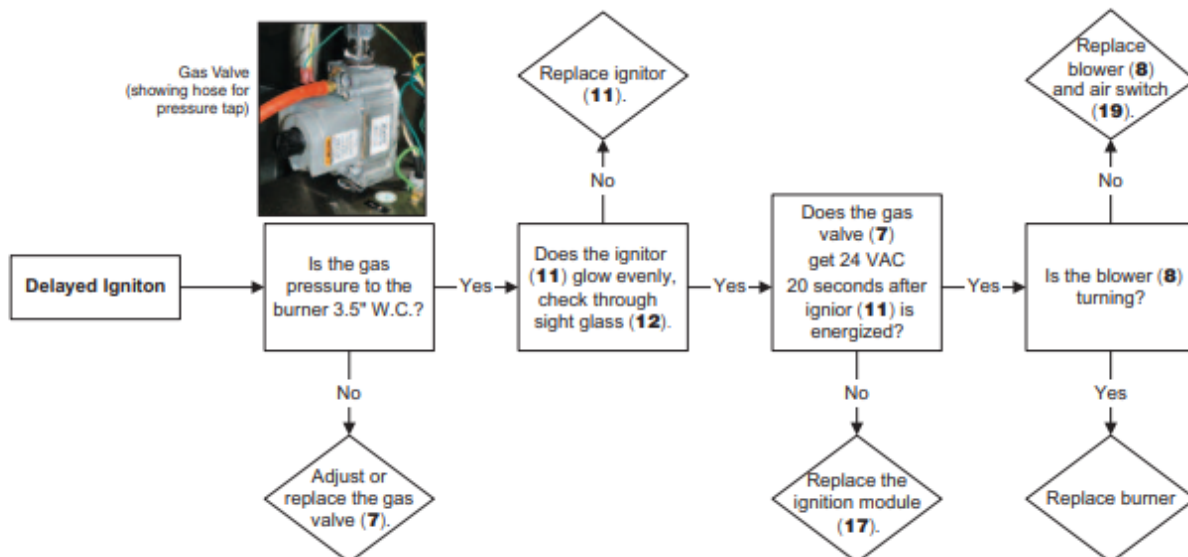

# TROUBLESHOOTING GUIDES (continued)

**Problem:**  
**Kettle gets too hot.**

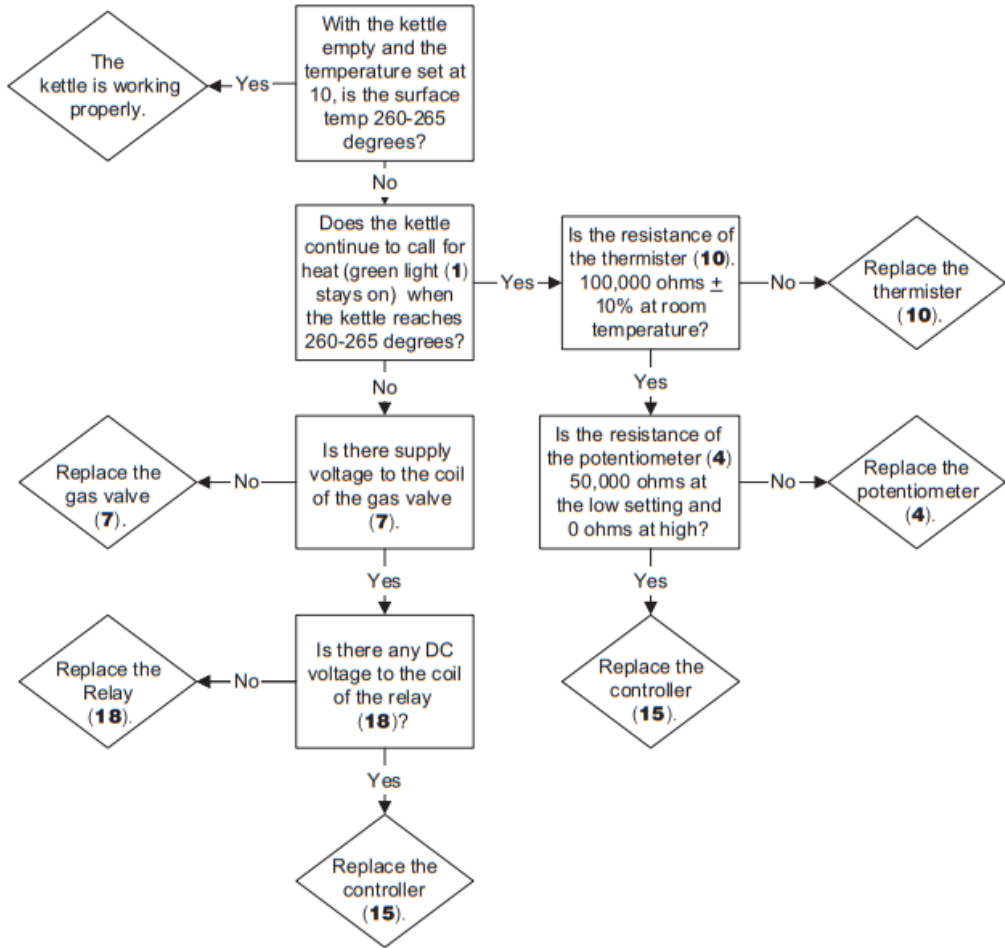

**PROBLEM: Red LED Stays On**

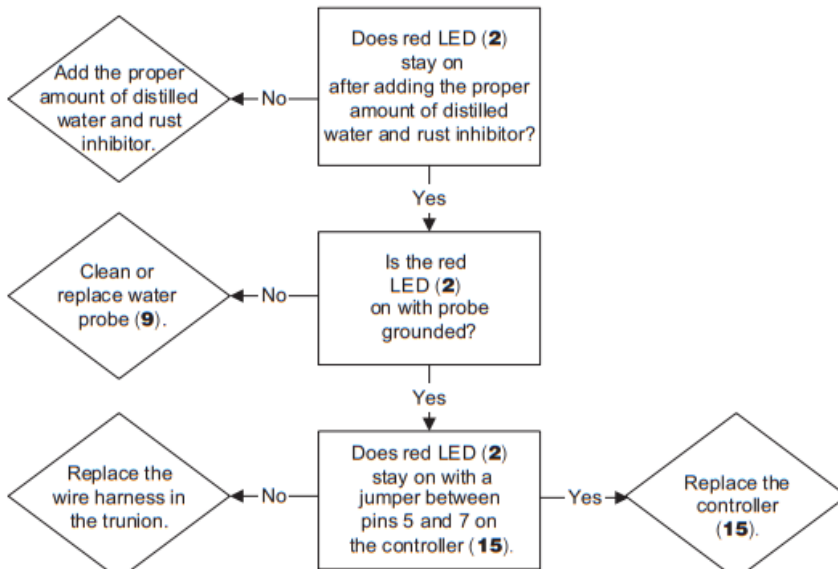

# KETTLE SAFETY INSPECTION AND TESTING

## SAFETY VALVE INSTALLATION:

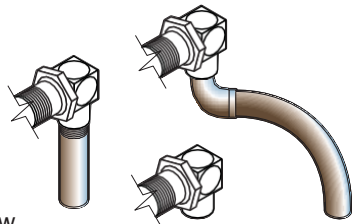

The above illustrations show the three variations of factory installed Safety Valves.

**Modifications are unacceptable.**

## SAFETY THERMOSTAT:

**Correct Installation**

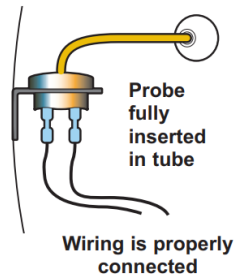

**Incorrect Installations**

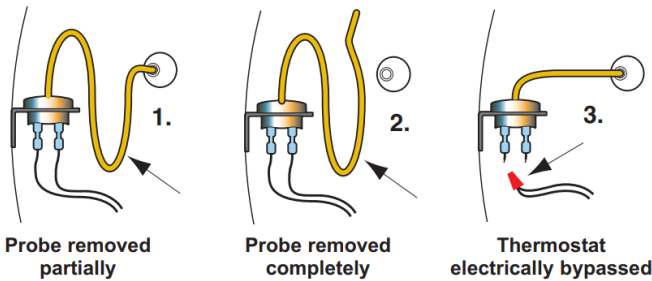

1. Safety thermostat probe is not completely inserted into tubing.
2. Safety thermostat probe is removed from tubing.
3. Safety thermostat electrical connection is bypassed.

## OPERATING THERMOSTAT:

If maximum temperature is not in this range (on empty kettle), refer to the "Calibrating Procedure".

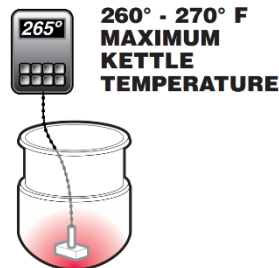

## GAS KETTLE AIR SWITCH:

**Correct**

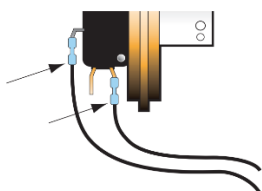

Wiring is properly connected

**Incorrect**

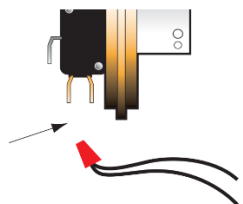

Switch electrically bypassed

## LOW WATER LEVEL PROBE:

Probe properly attached



**K** Probe bypassed by running (A) an additional wire



**K** Probe bypassed by (B) grounding the connecting wire

## PRESSURE RELIEF VALVE TESTING

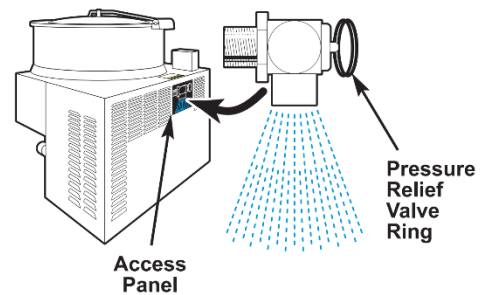

**WARNING:** Use of gloves and eye protection to prevent personal injury.

1. With the kettle empty, set On-Off Switch/Temperature Control to "10" (Max.). Allow the kettle to heat until the unit cycles off.
2. Switch On-Off Switch/Temperature Control to "0" (Off) and disconnect main power at fused disconnect switch.
3. Remove Access Panel at back of main kettle console.
4. Pull Pressure Relief Valve Ring open for a maximum of one second. Repeat test three to four times. Each time the mechanism should move freely and be accompanied by a rapid escape of steam.
5. Replace access panel.

### IMPORTANT:

If valve appears to be sticking replace pressure relief valve.

If foreign material is discharged then drain kettle and replace pressure relief valve.

## CALIBRATING PROCEDURE



1. Ensure the unit has a vacuum before you begin calibrating procedures. If unit requires venting refer to KETTLE VENTING INSTRUCTIONS.
2. Set On-Off Switch/Temperature Control to "10" (Max.).
3. Allow the unit to cycle twice.
4. Check temperature of the inner kettle surface with a digital surface thermometer.
5. Temperature should be between 260°F and 265°F.

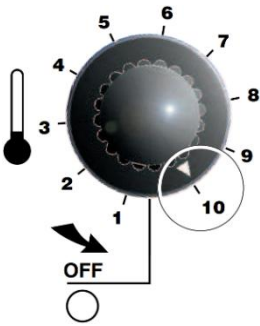

6. Using a screw driver adjust temperature by turning the potentiometer on the Solid State Temperature Control Box. Turn very little. Turn clockwise to INCREASE and counter-clockwise to DECREASE temperature.

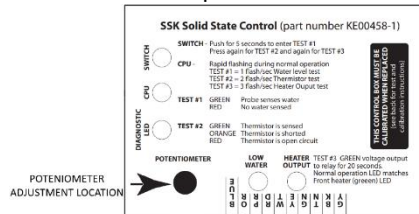

7. Allow the unit to cycle twice.
8. Check temperature of the inner kettle surface with a digital surface thermometer.
9. Repeat steps 4. through 8. until unit is calibrated

## FREE AIR CALCULATION

Insert drager pump tube 4" down the center of the flue and take one sample each of Carbon Dioxide (CO<sub>2</sub>) and Carbon Monoxide (CO) and record results. With results obtained for CO<sub>2</sub> use chart to determine dilution factor for gas type used. Enter these numbers in the following formula to determine the concentration of carbon monoxide in an air free sample of flue gas.

% CO (PPM)	% CO <sub>2</sub>
Dilution Factor	

$$\text{Dilution Factor} \times \frac{\text{CO (PPM)}}{10,000} = \frac{\text{Dilution Factor}}{\% \text{ Carbon Monoxide}}$$

Result must not exceed 0.08% carbon monoxide.

CARBON DIOXIDE IN SAMPLE (PERCENT)	FACTOR PROPANE GAS	FACTOR NATURAL GAS
4.0	3.50	3.05
4.2	3.33	2.90
4.4	3.18	2.77
4.6	3.04	2.65
4.8	2.92	2.54
5.0	2.80	2.44
5.2	2.69	2.34
5.4	2.59	2.26
5.6	2.50	2.18
5.8	2.41	2.10
6.0	2.33	2.03
6.2	2.26	1.97
6.4	2.19	1.91
6.6	2.12	1.85
6.8	2.06	1.80
7.0	2.00	1.74
7.2	1.94	1.70
7.4	1.89	1.65
7.6	1.84	1.61
7.8	1.79	1.56
8.0	1.75	1.53
8.2	1.71	1.49
8.4	1.67	1.45
8.6	1.63	1.42
8.8	1.59	1.39
9.0	1.56	1.36
9.2	1.52	1.33
9.4	1.49	1.30
9.6	1.46	1.27
9.8	1.43	1.24
10.0	1.40	1.22

## REPAIRING LEAKS IN STEAM JACKETED KETTLE FITTINGS

If unit will not hold a vacuum the most likely cause is a leak at one of the fittings.

Often, the easiest way to eliminate a leak is to reseal the suspect areas.

1. Water Level Probe  
Remove, clean threads, apply teflon thread sealant and reinstall.
2. Pressure Relief Valve  
A/ Inspect for signs of leaks. Replace if required.

B/ Remove, clean threads, apply teflon thread sealant and reinstall.

3. Pressure Gauge  
A/ Inspect face of gauge. If it contains moisture on the inside of face replace.  
B/ Check tightness of plumbing connection to pressure Gauge.
4. Sight Glass  
A/ Check tightness of sight glass.  
B/ Replace "O" ring if required.
5. If unsuccessful, repeat this process, replacing all fittings and components.

## KETTLE VENTING INSTRUCTIONS

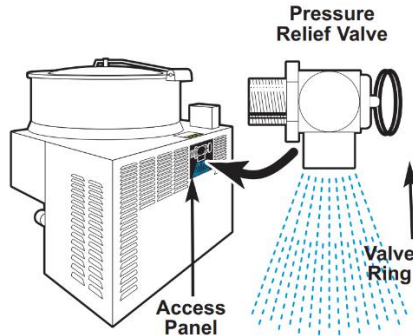
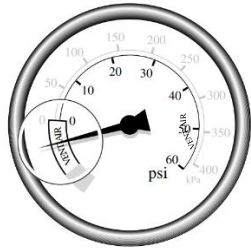

The following venting procedure should be followed when the Vacuum/Pressure Gauge needle is in the "VENT AIR" zone:

**NOTE:** Check for and eliminate leaks prior to venting (see REPAIRING LEAKS IN STEAM JACKETED KETTLE FITTINGS).

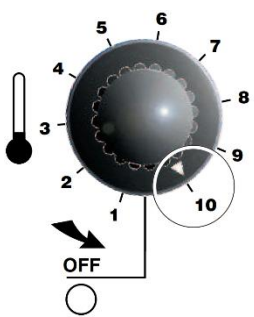

1. Remove Access Panel from back of main kettle console.
2. Turn kettle ON and set temperature control to **10**, heat the empty kettle until unit cycles off.
3. Vent kettle by pulling Valve Ring eight to fifteen times, holding valve open for two seconds each time.

**NOTE:** If unit cycles ON, stop venting and wait for kettle to cycle OFF before continuing.

4. Turn kettle OFF. Add cold water to kettle until its surface temperature is below 100°F. The pressure gauge needle should be in the green zone, indicating a vacuum in the kettle's jacket.

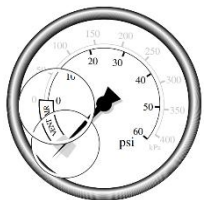
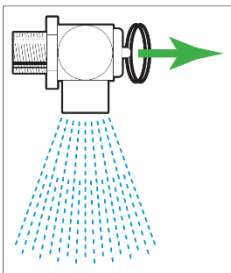

5. If needle is in the green zone then venting was successful. If not repeat procedure

## RESERVOIR FILL PROCEDURES

### WARNING:



Improper refilling of kettle jacket will result in irreversible damage to unit.

The kettle's water level must be maintained at the proper level. Under normal operating conditions, the sealed water reservoir should never require the addition of water.

If the red "low water" light comes on during use (while the kettle is in an upright position), the water level has reached a critically low level. The low water protection control has automatically shut off the gas burner. The following procedure must be completed before further use:

**NOTE:** Have a qualified service technician repair the leakage problem and add water to the unit. Ensure that the red "low water" light is on when the kettle is upright.

On tilting kettles, it is normal for the red light to come on when the kettle is in a tilted position.



1. Ensure kettle is at room temperature and pressure gauge showing zero or less pressure.
2. Shut off power to the kettle at the fused disconnect switch.

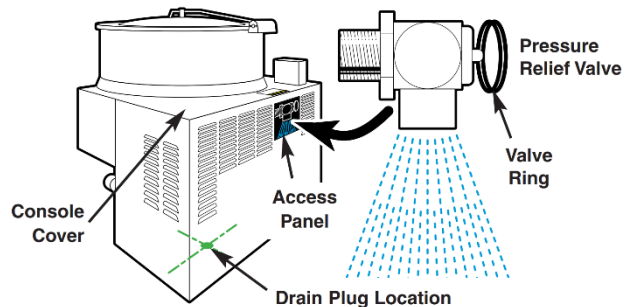

3. Remove Console Cover and Access Panel.

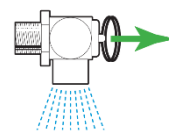

**Important-** Pull ring on Pressure Relief Valve prior to removal to ensure vessel is not pressurized.

4. Pull Pressure Relief Valve Ring open to ensure vessel is not pressurized.
5. Remove 1/4" copper tubing and reducer bushing.
6. Add distilled water using a funnel if necessary. Fill the unit to the high level mark on the Sight Glass.
7. Apply a thread sealant (i.e. Teflon tape) to the reducer bushing threads and replace.
8. Replace Console Cover and Access Panel.
9. Restore power to unit at the fused disconnect switch.
10. The kettle must now be vented. (Refer to the KETTLE VENTING INSTRUCTIONS).



**Sight Glass**

# KETTLE JACKET CLEANOUT AND PASSIVATION PROCEDURES

The following procedure should be performed at least once every three years to prevent possible corrosion and ensure the optimum life of the kettle.

## RUST INHIBITOR

Use a “radiator rust inhibitor” that can be purchased at your local automotive centre. It should not contain any anti-freeze and preferably no lubricant.

To ensure satisfactory mixing follow the manufacturer’s instructions.

DISPOSAL - Follow all Federal, State and local codes when disposing of product.

### DANGER:



Rust inhibitor can be dangerous. Read label and follow safety instructions.

### WARNING:



Improper refilling of kettle jacket will result in irreversible damage to unit.



## PRESSURE RELIEF VALVE PERIODIC TESTING PROCEDURE



1. Ensure kettle is at room temperature and pressure gauge showing zero or less pressure.
2. Shut off and disconnect gas supply.
3. Remove electrical plug from power source.

4. Remove bolts holding kettle to tabletop.
5. Pull ring on pressure relief valve to ensure there is no pressure within the kettle jacket.
6. Remove pressure relief valve.
7. Replace pressure relief valve with street elbow (see above illustration).
8. Remove sight glass from left side of kettle.
9. Tilt kettle on its side (sight glass opening facing downwards) and allow to drain. Flush out with water.
10. Tilt kettle upright, apply a thread sealant (i.e. Teflon tape) to the sight glass threads and replace.
11. Refer to chart below to determine the required volume of water.

Kettle Size	Volume of Mixture	
	U.S. Gal.	Liters
6 U.S. Gal.	1.6	5.8
12 U.S. Gal.	2.2	8.3

12. In a separate container mix water with the required rust inhibitor.
13. Fill jacket via the street elbow with the mixture.
14. Remove street elbow.
15. Apply a thread sealant (i.e. Teflon tape) to the pressure relief valve and replace.
16. Reconnect gas and electrical supplies.
17. Turn kettle on, vent and heat to high for 1/2 hour.
18. Cool kettle.
19. Repeat steps 5-15.
20. Replace bolts holding kettle to tabletop.
21. Reconnect gas and electrical supplies.
22. Turn kettle on and vent kettle.

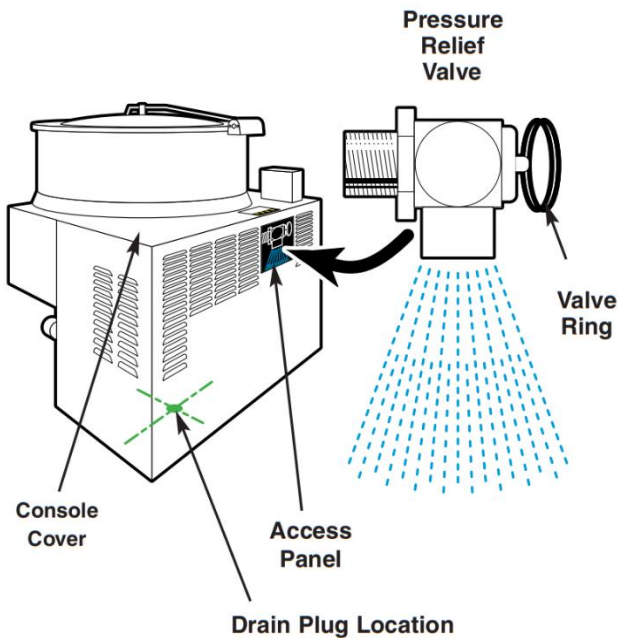

## LUBRICATION

Lubricate the following parts every three months to ensure smooth operation and reduce wear.

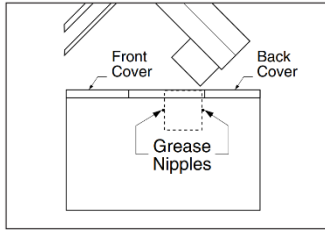

### MIXER BRIDGE HOUSING

There are two grease nipples on the mixer bridge swivel housing which are accessed by removing the front and back covers on the 18" console.

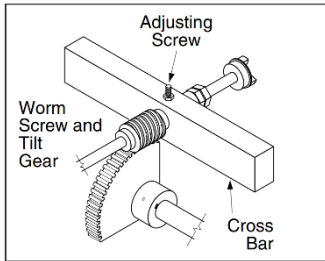

### TRUNNION HOUSING, WORM SCREW AND TILT GEAR

These parts are accessed through the front cover on the 18" console.

Apply grease to gear teeth. Check for excessive play and adjust with adjusting screw located on top of cross bar.

### KETTLE TRUNNIONS

Accessed via the top covers on the 10" and 18" consoles. Each has two grease nipples.

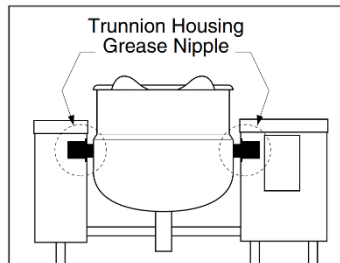

## HYDRAULIC OIL REPLACEMENT PROCEDURE

One of the most important maintenance tasks is to change the hydraulic oil yearly. Under heavy usage the oil should be changed every nine months. It is important to change the oil regularly to prevent its breakdown which leads to the damaging of components.

The oil filter should be changed at the same time as the hydraulic oil. A clean filter prevents particles from damaging the other components in the system.

Replace the hydraulic fluid as follows:

- ⇒ Disconnect power to unit.
- ⇒ Remove the front top panel on the main console.
- ⇒ Remove chrome vent cap from breather pipe located beside electric motor.
- ⇒ Remove plug bolt from bottom left front corner of main console to drain oil into your catch pail.
- ⇒ Remove oil filter.
- ⇒ Replace plug bolt.
- ⇒ Refill unit through breather pipe using approximately 12 U.S. gallons of Tellus 32 hydraulic oil (oil should be 6 1/2" deep in tank).
- ⇒ Install new oil filter (Part# [SE50094](#)).
- ⇒ Replace chrome vent cap and front top panel.
- ⇒ Reconnect power to unit.
- ⇒ Run unit to remove any air in the lines.

## RE-INSTALLING SPEED CONTROL CABLE

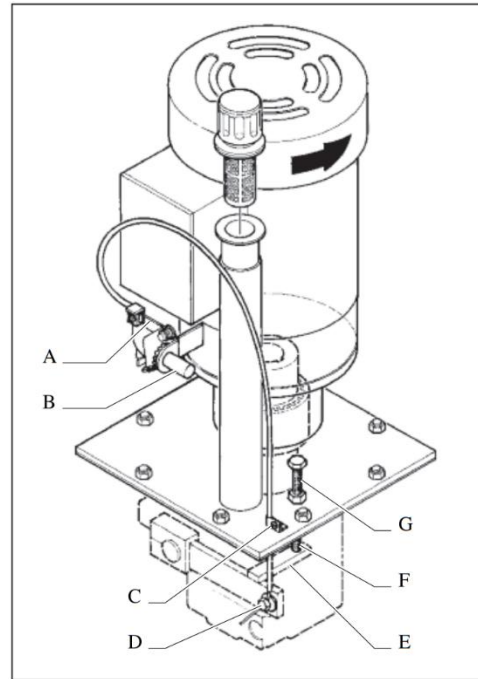

1. Turn sprocket of speed control so that wire "A" is fully extended towards shaft "B".
2. Insert end of cable through bracket "C".
3. Insert wire so it protrudes approximately 1/2" to 5/8" through hole in bolt "D". Tighten bolt and bend end of wire.
4. Bring pump arm "E" up until it hits stop bolt "F" and tighten screw "C".
5. Reassemble unit. Speed control knob will go on pointing toward minimum setting.
6. Turn mixer on with speed control set at minimum setting.
7. If scraper arm is turning, loosen nut "G" and back stop bolt "F" off a few turns. Next loosen screw "C" and slowly pull up cable until scraper arm stops turning. Retighten screw "C". Gently turn stop bolt "F" down until it hits arm. Lock in place by tightening nut "G".
8. Scraper arm should now go from no rotation to fast rotation by turning speed control knob.

**NOTE:** Mixer may run rough and noisy for one or two hours if air has become trapped in the line.

## AIR LINE LUBRICATOR OIL FILLING PROCEDURE

1. Disconnect air supply and bleed system.
2. Remove cover on console
3. Check for oiler location.
4. Inspect oil level in bowl.
5. Remove filler cap.
6. Add mineral oil as required.
7. Replace filler cap and console cover.

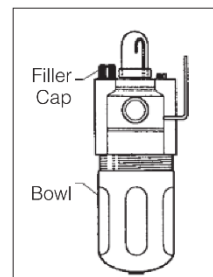

Every new piece of Welbilt Foodservice equipment comes with KitchenCare® and you choose the level of service that meets your operational needs from one restaurant to multiple locations

**StarCare** – Warranty & lifetime service, certified OEM parts, global parts inventory, performance audited

**ExtraCare** – CareCode, 24/7 Support, online/mobile product information

**LifeCare** – Install & equipment orientation, planned maintenance, KitchenConnect™, MenuConnect®

**Talk with KitchenCare®** • 1-844-724-CARE • [www.mtwkitchencares.com](http://www.mtwkitchencares.com)



To learn how Welbilt Foodservice and its leading brands can equip you, visit our global web site at [www.welbilt.com](http://www.welbilt.com), then discover the regional or local resources available to you.