



CARRIER COMMERCIAL REFRIGERATION, INC.

Providing BEVERAGE-AIR • FRIGIDAIRE • KELVINATOR • UNIVERSAL NOLIN Products/Services

# SERVICE & INSTALLATION MANUAL



## Modular Merchandiser



1/2003

51-0195-01

**If additional information is necessary, call the factory.**

Our toll free number is **1-800-684-1199**. Technical assistance engineers are willing to assist you in any way possible. Office hours are from 8:00 a.m. to 5:30 p.m., Eastern Standard Time.

## MODEL DESIGNATION INFORMATION

### 115V, 60HZ

PART #	MODEL #	DATA PLATE	STYLE
52-1029-01	CRPD3	CRPD3	MEDIUM TEMP, CURVED
52-1029-02	CRPD4	CRPD4	MEDIUM TEMP, CURVED
52-1029-05	CRPD6	CRPD6	MEDIUM TEMP, CURVED
52-1030-01	RPD3	RPD3	MEDIUM TEM, STRAIGHT
52-1030-02	RPD4	RPD4	MEDIUM TEMP, STRAIGHT
52-1030-04	RPD4PT	RPD4	MEDIUM TEMP, STRAIGHT
52-1030-05	RPD6	RPD6	MEDIUM TEMP, STRAIGHT
52-1031-01	CDPD3	CDPD3	DRY, NON REF, CURVED
52-1031-02	CDPD4	CDPD4	DRY, NON REF, CURVED
52-1031-05	CDPD6	CDPD6	DRY, NON REF, CURVED
52-1032-01	DPD3	DPD3	DRY, NON REF, STRAIGHT
52-1032-02	DPD4	DPD4	DRY, NON REF, STRAIGHT
52-1032-05	DPD6	DPD6	DRY, NON REF, STRAIGHT
52-1033-01	CFPD3	CFPD3	LOW TEMP, CURVED
52-1033-02	CFPD4	CFPD4	LOW TEMP, CURVED
52-1034-01	FPD3	FPD3	LOW TEMP, STRAIGHT
52-1034-02	FPD4	FPD4	LOW TEMP, STRAIGHT
52-1035-01	COHM3	COHM3	MEDIUM, OPEN, CURVED
52-1035-02	COHM4	COHM4	MEDIUM, OPEN, CURVED
52-1035-03	COHM6	COHM6	MEDIUM, OPEN, CURVED
52-1036-01	OHM3	OHM3	MEDIUM, OPEN, STRAIGHT
52-1036-02	OHM4	OHM4	MEDIUM, OPEN, STRAIGHT
52-1036-03	OHM6	OHM6	MEDIUM, OPEN, STRAIGHT
52-1036-04	OHM3 BLACK	OHM3	MEDIUM, OPEN, STRAIGHT
52-1047-02	BRD52	BRD52	LOW TEMP, STRAIGHT

### EXPORT 220V, 50HZ

PART #	MODEL #	DATA PLATE	STYLE
52-1033-05	ECFPD4	ECFPD4	LOW TEMP, CURVED
52-1034-05	EFPD4	EFPD4	LOW TEMP, STRAIGHT
52-1047-06	EBRD52	EBRD52	LOW TEMP, STRAIGHT

### EXPORT 220V, 60HZ

PART #	MODEL #	DATA PLATE	STYLE
52-1033-03	KCFPD4	KCFPD4	LOW TEMP, CURVED
52-1033-04	KCFPD4C	KCFPD4	LOW TEMP, CURVED
52-1034-03	KFPD4	KFPD4	LOW TEMP, STRAIGHT
52-1034-04	KFPD4C	KFPD4	LOW TEMP, STRAIGHT
52-1047-04	KBRD52	KBRD52	LOW TEMP, STRAIGHT

Important information is contained in this manual which should be retained in a convenient location for future reference.

*Information in this manual is subject to change without notice.*

Manual effective for models produced January, 2003.

Starting serial number 6701822.

# SPECIFICATIONS - DISPLAY CABINETS

	MED TEMP	LOW TEMP
<b>Temperature Range</b>	32°F to 60°F	0°F to -15°F
<b>Insulation</b>	2 3/8" Foam in Place	2 5/8" Foam in Place
<b>Compressor Size</b>	1/2 H.P.	1 H.P.
<b>Condenser Type</b>	Fin & Tube	Fin & Tube
<b>Evaporator Type</b>	Fin & Tube Slow Moving Air	Fin & Tube Slow Moving Air
<b>Refrigerant Type</b>	404A	404A
<b>Defrost System</b>	On Demand	On Demand
<b>Electrical Specs.</b>	115/60/1	115/60/1
<b>NSF</b>	NSF 1	NSF 1
<b>Shelves</b>	Shelves, Epoxy Coated, Bracket Supported	Shelves, Epoxy Coated, Bracket Supported
<b>UL &amp; CSA Listing</b>	Yes	Yes

## DIMENSION DRAWINGS - COHM & OHM



## DIMENSION DRAWINGS - FPD, CFPD, RPD & CRPD



# GENERAL INFORMATION

## An Important Message for Installers and Operators

These instructions include information which is intended to assure the operator of correct installation, operation and service. Before attempting installation, adjustment or maintenance be certain of the following:

1. That you have read and fully understand the instructions.
2. That you have all tools required and are trained to use them.
3. That you have met all installation and usage restrictions and are familiar with the functions and operation of the unit.
4. That you follow all instructions exactly as given.

All fittings, measurements, procedures and recommendations are significant. Substitutions and approximations must be avoided. Improper handling, maintenance, installation and adjustment, or service attempted by anyone other than a qualified technician, may void the future warranty claims and cause damage to the unit and/or result in injury to the operator and/or bystanders.

**Important Information Is contained In these instructions which should be retained in a convenient location for future reference.**

Record for Service \_\_\_\_\_

Model No. \_\_\_\_\_

Serial No. \_\_\_\_\_

Invoice Date \_\_\_\_\_

Start-up Date \_\_\_\_\_

Telephone for Service \_\_\_\_\_

BE SURE TO INSPECT CABINET FOR SHIPPING DAMAGE BEFORE AND AFTER UNCRATING IT.

## HANDLING & INSTALLATION Inspecting for Damage

NOTE: The transportation company or other parties involved in the shipment are responsible for loss and/or damage. When direct delivery was made by the trans-

portation company, follow the procedure as outlined in the following steps: Always make an Inspection before and after uncrating. Inspect the uncrated unit(s) before locating (preferably at the point of unloading by the transportation company.) You may leave the skid on the unit for ease of locating it later.

- a. Damaged cartons or containers - If these are damaged in any way, open them and inspect the contents in the driver's presence.
- b. Have the driver note the nature and extent of the damage on the freight bill.
- c. Notify the transportation company's office to request an inspection. Carrier claim policies usually require inspections to be made within 15 days of delivery.
- d. Always use care when removing shipping tape, blocks, pads, hardware, or other materials. Retain all crate and packaging material until you are satisfied that the unit is completely operational.
- e. Contact factory if technical assistance is required.
- f. If damage is noticed (whether before or after uncrating the unit) the following claim procedure must be completed.

## Inspecting for Shortages

NOTE: Refer to the "Inspecting for Damage" instructions and follow the procedure described.

- a. Check the number of cartons and/or containers delivered with the quantity shown on your receipt.
- b. If the quantities are not the same, have the driver note the shortage and file your claim accordingly.

## Filing Claims

a. File a claim for loss or damage at once with the transportation company for:

- 1) A cash adjustment
- 2) Repairs
- 3) Replacement

b. When filing your claim, retain all packaging materials and receipts.

## Handling the Cabinet

The refrigeration system of the cabinet is designed to operate with the cabinet located on a flat surface. Avoid tilting the cabinet more than 30° to any side. If the cabinet must be tilted on an angle for handling or moving purposes, allow it to sit in an upright position 20 to 30 minutes prior to plugging it in and starting the cooling of the storage compartment.

# GENERAL INFORMATION-cont.

## Removing the Skid

Remove the four (4) bolts securing the cabinet to four (4) angle brackets attached to the skid. Remove the skid bolts and angle brackets. Carefully slide the cabinet off the skid onto the floor.

## Locating the Cabinet

This model is a display cabinet and should be positioned to expose the illuminated displays to customers in the store and provide a clear space behind for the person serving.

Select a location where you are sure that the cabinet won't be exposed to heat sources such as sun through a window, store heating or cooling ducts, exhausts from other cabinets, etc. Make sure there is adequate space on the serving side for loading cabinet and serving efficiently.

**DO NOT DRILL HOLES IN THE CABINET WALLS. THIS WILL VOID THE WARRANTY**

- The cabinet must be installed on a sturdy and solid, level floor.
- The cabinet should be installed in a protected, dry, and well-ventilated area, away from any heat source.

## Leveling the Cabinet

Level the cabinet using a spirit level on top. Level front to back and side to side to assure a quiet operation and satisfactory door and drain operation. Doors are self-closing (sliding door models only) when cabinet is level. Shim under the cabinet base as necessary to assure a level cabinet. To meet NSF requirements, these cabinets must be sealed to the floor with an NSF listed or FDA approved sealant.

## Setting up the Cabinet

Cabinets are shipped with the adjustable shelf mounting brackets in place. Shelving is also supplied with the cabinet.

Shipping material (cardboard, paper, plastic, ties, etc.) should be removed from shelving and the product area.

**CAUTION:** Make sure that the shelf light plugs or receptacle covers are completely inserted into the light socket receptacles. This prevents electrical arcing and/or possible equipment damage.

## Grounding Instructions

This appliance is equipped with a three-prong (grounding) plug for your protection against shock hazards. The appliance should be plugged directly into a properly grounded three prong receptacle.

Where a two-prong wall receptacle is encountered, it must be replaced with a properly grounded three-prong receptacle in accordance with the National Electrical Code and local codes and ordinances. The work must be done by a licensed electrician (cabinet should be on a dedicated circuit unto itself. Refer to serial data for correct circuit ampacity).



# GENERAL INFORMATION-cont.

## Power Supply Switch

NOTE: When servicing or cleaning supply power must be turned off. The power supply switch is located at the rear of each cabinet behind the lower rear grill. The switch is incorporated into the electrical box assembly.

### Light Switch-Auxiliary Outlet

The light switch is located at the rear of each cabinet (when applicable) just above the unit compartment opening on the right hand side.

The auxiliary outlet is provided to power an external sign scale (when applicable).

These cabinets utilize a microprocessor control to manage both cavity temperature and defrost functions.

## Cabinet Operation-Refrigeration Mode

Upon setting the cabinet in it's final location, turn power supply on. The cabinet display should be indicating the cabinet temperature. There is a three minute time delay sequence built in each time the supply power is lost (compressor circuit). Evaporator fan starts and lights come on (medium temp models). Three minutes later the compressor starts. On low temp models the evaporator fan delays until the evaporator coil reaches 28°F.

The display located on the lower front panel has several functions,

Display cabinet temperature

Change cavity set point temperature

**NOTE: ON MED TEMP CABINETS DO NOT SET BELOW 33°F.**

Display service interface. Only qualified service personnel should activate this function.

## Defrost Mode

This is on a demand basis as needed on both medium and low temperature models. Defrost can be manually activated through the display if needed. See below.

High Temp Thermodisc Open 140°F } Low temp models only  
Close 90°F }

### Notable points

1. This system utilizes a 3 minute off cycle timer to prevent short cycles.
2. When the system initiates a defrost, the setpoint will flash on and off until the defrost is terminated and the cavity reaches the setpoint. At this time the cavity tem-

perature will be displayed as normal.

## Changing Setpoint



**Note: Use a paper clip to access the function keys.**

1. Pressing the top right button(i.e. up key) on the display unit will raise the set point one degree Fahrenheit. Holding the button down will scroll the adjustment.
2. Pressing the lower right button(i.e. down key) on the display unit will lower the set point one degree Fahrenheit.

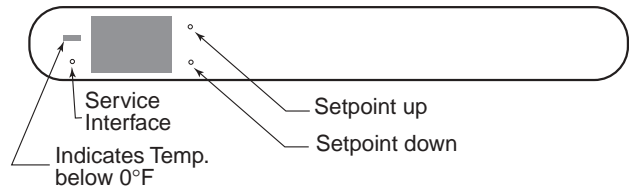

## The Service Interface and the Service Menu

(Refer to Pulse Service Manual 51-2484-00 for complete service information.)

The service menu offers the service technician direct control of the components of the system. This allows the technician to force the system into a defrost state or the refrigeration state. This feature also allows the technician to toggle the state in order to analyze separate components of the system (e.g., start kit, compressor, heaters, etc.).

1. To access the service menu, press and hold the service key for 2 seconds. The system will enter the service menu and c0 will alternately flash with evaporator temperature. Code versions 1.5 and earlier do not display evaporator temperature. This is the top of the service menu. To exit the service menu, press the service key again at any time.
2. The service menu offers five functions: Refrigeration state, Defrost state, code revision level indication, the option to blank the display (code version 1.6 and later), and Celsius or Fahrenheit operation (code version 1.6 and later). While in the service menu,

## GENERAL INFORMATION-cont.

the down key serves to scroll the menu and the up key serves as a toggle to activate and deactivate the function state.

- A.** To access the functions simply press the down key to scroll through the menu until the desired function is reached. The Refrigeration state is the first function and is denoted by an alternating display of **c0** and the evaporator temperature. The Defrost state is the second function and is denoted by a display of **d0**. The third function is a passive state and only indicates which version of code is running. This function alternately flashes **cc** and the code version **01 - 99**. The fourth function allows the user the option to blank the display and is denoted by **S0**. The fifth and last option allows the user to select between Fahrenheit and Celsius operation and is denoted by a **C** or a **F**. Continuing to scroll will bring the user to the top of the menu again where **c0** will be displayed.
- B.** To activate a function state, simply press the down key to scroll the menu until the desired function is reached. Now press the up key. At this point the chosen function state is toggled from inactive to active.
- C.** To force a defrost: First press and hold the service button to enter the service menu. Then press the down key until **d0** is displayed. Next press the up key. The heater is now energized and **d1** is displayed.
- D.** To activate the refrigeration state: (i.e., this turns on the compressor, condenser fans, and evaporator fans) First enter the service menu. Press the top

right button. **c0** will change to **c1**. Use this function to check refrigerant charge and pressures, evaporator fans, compressor and start components and etc.

- E.** To deactivate the function state, press the up key again (i.e., this button toggles the state from active to inactive and vice versa).

- NOTES:
- a. When an attempt is made to scroll the menu while a function state is active, the active function state will automatically deactivate. This is to prevent the service technician from simultaneously activating the Refrigeration state and the Defrost state. Only one function may be active at any given time.
  - b. If no operation is performed within 45 minutes while in the service menu, the system will automatically exit the service menu and return to normal refrigeration.
  - c. If the Defrost state is activated and left unattended, the service menu will terminate the defrost as normal on evaporator temperature; otherwise, the defrost will terminate in 45 minutes. Upon defrost termination the system will automatically exit the service menu.
  - d. When the system exits the service menu, the compressor will not start for 3 minutes.
  - e. The off cycle timer is not incorporated in the service menu so the service technician has direct control of components.

# ELECTRICAL/REFRIGERATION SPECIFICATIONS

## SYSTEM COMPONENTS - RPD3, CRPD3, RPD6, CRPD6

Compressor	Americold
Compressor Model	HP 127
Recommended Operating Temp. Range	36°F to 42°F
Cabinet Volts	115
Expansion Device	7' x .054 Capillary Tube
Charge Refrig. Type / Oz. / Grams	R-404 / 16 / 453.6 grams

## SYSTEM PERFORMANCE - (READINGS AT CUT-OUT)

AMBIENT	70°F			80°F			90°F		
Display setting	41°	36°	31°	41°	36°	31°	41°	36°	31°
Cavity Temp. (F)	42°	37°	3°	42°	37°	32°	43°	38°	32°
Suction Pressure (PSIG)	47	39	34	47	41	36	51	43	39
Discharge Pressure (PSIG)	249	231	223	281	268	256	317	303	242
Compressor Amps (Each Compressor)	6.1	5.7	5.6	6.3	6.0	5.7	6.5	6.2	6.0
Total Refrigeration Amps (RPD3, CRPD3)	8.3	7	7	8.5	8.2	7.8	8.6	8.4	8.1
Total Refrigeration Amps (RPD6, CRPD6)	17.0	16.3	15.6	16.6	15.9	15.2	17.5	16.2	15.5

# ELECTRICAL/REFRIGERATION SPECIFICATIONS

## SYSTEM COMPONENTS - RPD4 & CRPD4

Compressor	Americold
Compressor Model	HP 127
Recommended Operating Temp. Range	36° TO 42°
Cabinet Volts	115
Expansion Device	7' x .054 Capillary Tube
Charge Refrig. Type / Oz. / Grams	R-404 /24 / 680.4 grams

## SYSTEM PERFORMANCE - (READINGS AT CUT-OUT)

AMBIENT	70°F			80°F			90°F		
Display setting	41°	36°	31°	41°	36°	31°	41°	36°	31°
Cavity Temp. (F)	39°	35°	30°	39°	35°	30°	39°	34°	30°
Suction Pressure (PSIG)	47	41	36	47	42	37	48	43	39
Discharge Pressure (PSIG)	255	245	233	286	276	262	320	309	297
Compressor Amps	5.9	5.6	5.3	6.0	5.7	5.5	6.2	5.9	5.7
Total Refrigeration Amps	7.9	7.5	7.3	8.0	7.7	7.5	8.2	7.8	7.6

# ELECTRICAL/REFRIGERATION SPECIFICATIONS

## SYSTEM COMPONENTS - OHM3, COHM3, OHM6, COHM6

Compressor	Americold
Compressor Model	HP 127
Recommended Operating Temp. Range	36°F to 42°F
Cabinet Volts	115
Expansion Device	7' x .054 Capillary Tube
Charge Refrig. Type / Oz. / Grams	R-404 / 18 / 510.3 grams

## SYSTEM PERFORMANCE - (READINGS AT CUT-OUT)

AMBIENT	70°F			80°F			90°F		
Display setting	41°	36°	31°	41°	36°	31°	41°	36°	31°
Cavity Temp. (F)	41°	37°	33°	42°	38°	34°	44°	41°	37°
Suction Pressure (PSIG)	45	43	37	46	44	40	47	46	40
Discharge Pressure (PSIG)	251	245	233	280	271	267	310	307	293
Compressor Amps (Each Compressor)	7.0	6.8	6.5	7.1	7.0	6.8	7.3	7.2	6.9
Total Refrigeration Amps (OHM3, COHM3)	7.9	7.8	7.4	8.1	7.9	7.7	8.2	8.2	7.8
Total Refrigeration Amps (OHM6, COHM6)	11.6	11.4	11.2	11.7	11.1	11.4	11.6	11.2	11.3

# ELECTRICAL/REFRIGERATION SPECIFICATIONS

## SYSTEM COMPONENTS - OHM4 & COHM4

Compressor	Americold
Compressor Model	HP 127
Recommended Operating Temp. Range	36° TO 42°
Cabinet Volts	115
Expansion Device	7' x .054 Capillary Tube
Charge Refrig. Type / Oz. / Grams	R-404 /25 / 708.7 grams

## SYSTEM PERFORMANCE - (READINGS AT CUT-OUT)

AMBIENT	70°F			80°F			90°F		
Display setting	41°	36°	31°	41°	36°	31°	41°	36°	31°
Cavity Temp. (F)	43°	37°	34°	43°	40°	35°	44°	41°	39°
Suction Pressure (PSIG)	50	45	41	49	46	43	49	47	40
Discharge Pressure (PSIG)	269	254	247	295	283	283	326	323	304
Compressor Amps	6.2	6.0	5.7	6.3	6.2	6.1	6.5	6.5	5.9
Total Refrigeration Amps	9.0	8.5	8.3	9.1	8.7	8.6	9.3	9.0	8.7

# ELECTRICAL/REFRIGERATION SPECIFICATIONS

## SYSTEM COMPONENTS - FPD3 & CFPD3

Compressor	Copeland
Compressor Model	RS80CIECAA
Recommended Operating Temp. Range	36°F to 42°F
Cabinet Volts	115
Expansion Device	7' x .049 Capillary Tube
Charge Refrig. Type / Oz. / Grams	R-404 / 14 / 396.9 grams

## SYSTEM PERFORMANCE - (READINGS AT CUT-OUT)

AMBIENT	70°F			80°F			90°F		
Display setting	+5°	-5°	-15°	+5°	-5°	-15°	+5°	-5°	-15°
Cavity Temp. (F)	+5°	-3°	-13°	+5°	-3°	-13°	6.1°	-3°	-12°
Suction Pressure (PSIG)	11.2	8.1	5.2	13	10	7.2	15	12	10
Discharge Pressure (PSIG)	262	244	216	296	272	246	334	311	289
Compressor Amps	9.0	8.3	7.7	9.2	8.6	7.8	9.3	8.7	8.3
Total Refrigeration Amps	12.0	11.3	10.7	12.3	11.6	10.9	12.3	11.8	11.3

# ELECTRICAL/REFRIGERATION SPECIFICATIONS

## SYSTEM COMPONENTS

	FPD4 CFPD4 BRD52	EFPD4 ECFPD4 EBRD52	KFPD4 KCFPD4 KBRD52
Compressor	Copeland	Copeland	Copeland
Compressor Model	RS80C1ECAA	RS80C2ECAZ-250	RS80C2ECAV
Cabinet Volts	115V 60Hz	220V 50Hz	220V 60Hz
Recommended Operating Temp. Range	36° TO 42°		
Expansion Device	7' x .049 Capillary Tube		
Charge Refrig. Type / Oz. / Grams	R-404 /16/ 453.6 grams		

## SYSTEM PERFORMANCE - (READINGS AT CUT-OUT)

AMBIENT	70°F			80°F			90°F		
Display setting	+5°	-5°	-15°	+5°	-5°	-15°	+5°	-5°	-15°
Cavity Temp. (F)	6.0°	-2°	-11°	6.0°	-2°	-11°	1.0°	-2°	-12°
Suction Pressure (PSIG) (115V)	10	8	6	12	10	7	14	12	9
Discharge Pressure (PSIG) (115V)	230	228	213	270	263	245	303	291	280
Compressor Amps (115V)	8.4	8.7	8.5	8.8	8.9	8.2	9.1	9.1	8.8
Total Refrigeration Amps (115V)	12.9	13.1	12.8	13.3	13.3	12.5	13.6	13.6	13.1
Suction Pressure (PSIG) (220V)	7.7	7.2	5.7	10.2	9.2	7.1	12.7	11.1	8.7
Discharge Pressure (PSIG) (220V)	211.1	209.0	203.5	245.3	239.6	232.3	281.2	272.5	263.6
Compressor Amps (220V)	5.0	5.0	4.7	5.0	5.2	4.8	5.6	5.4	4.9
Total Refrigeration Amps (220V)	6.1	6.0	5.9	6.3	6.2	5.9	6.5	6.3	6.1



# WIRING DIAGRAM – CFPD3, CFPD4, FPD3, FPD4, BRD52

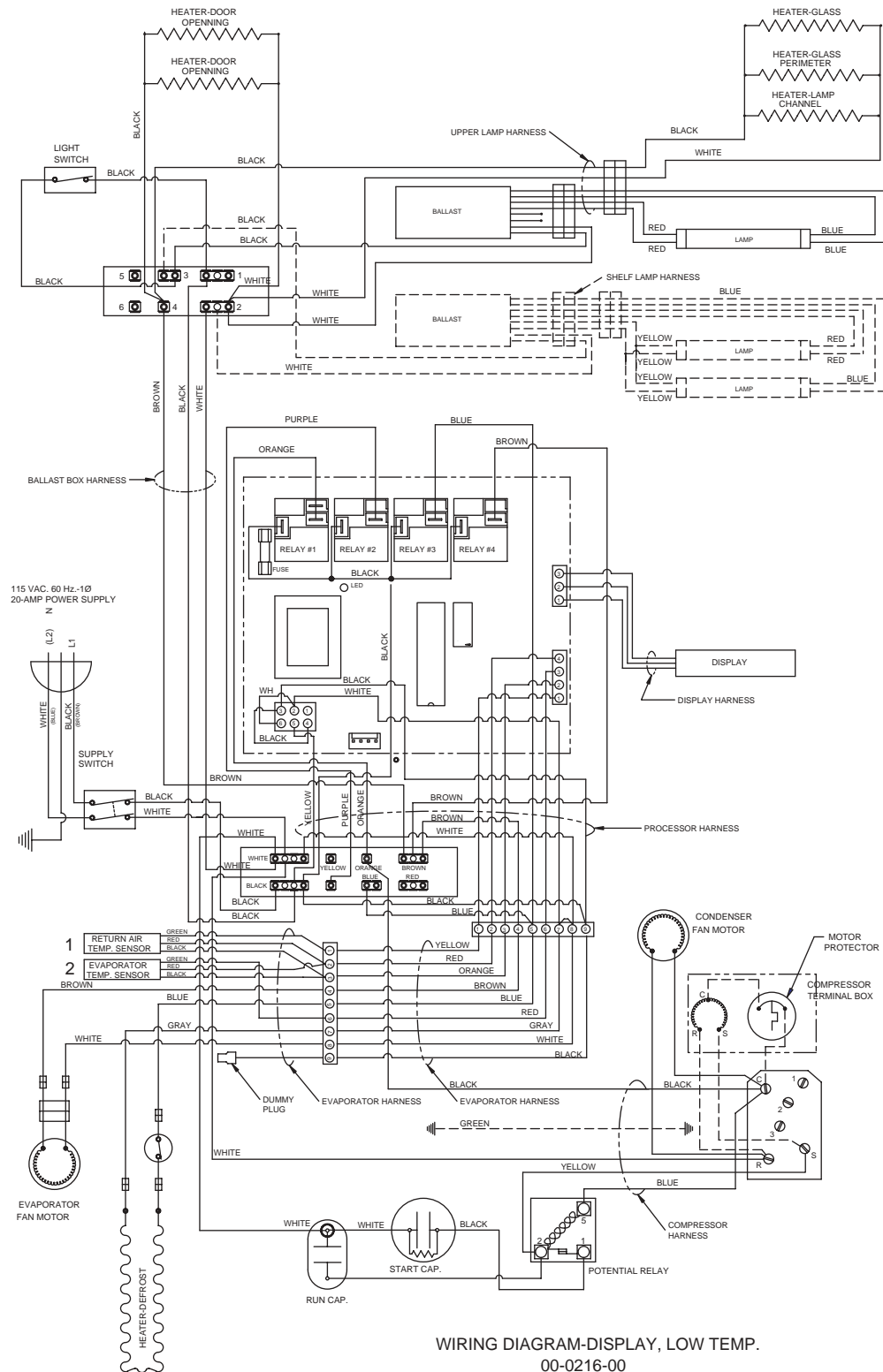

# WIRING DIAGRAM – CRPD3, CRPD4, RPD3, RPD4

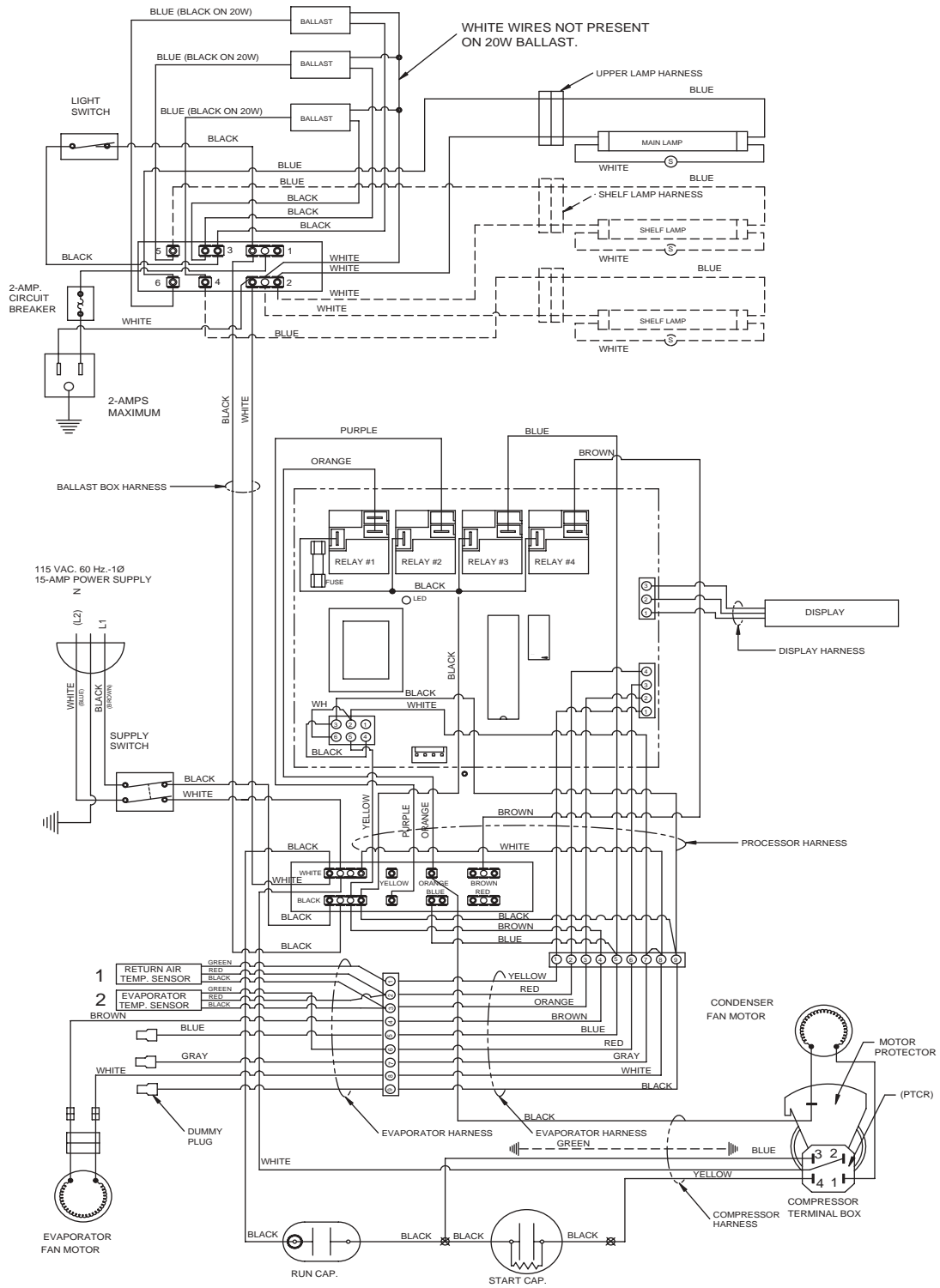

WIRING DIAGRAM-DISPLAY, MED-TEMP.  
00-0217-00





# WIRING DIAGRAM – CRPD6, RPD6

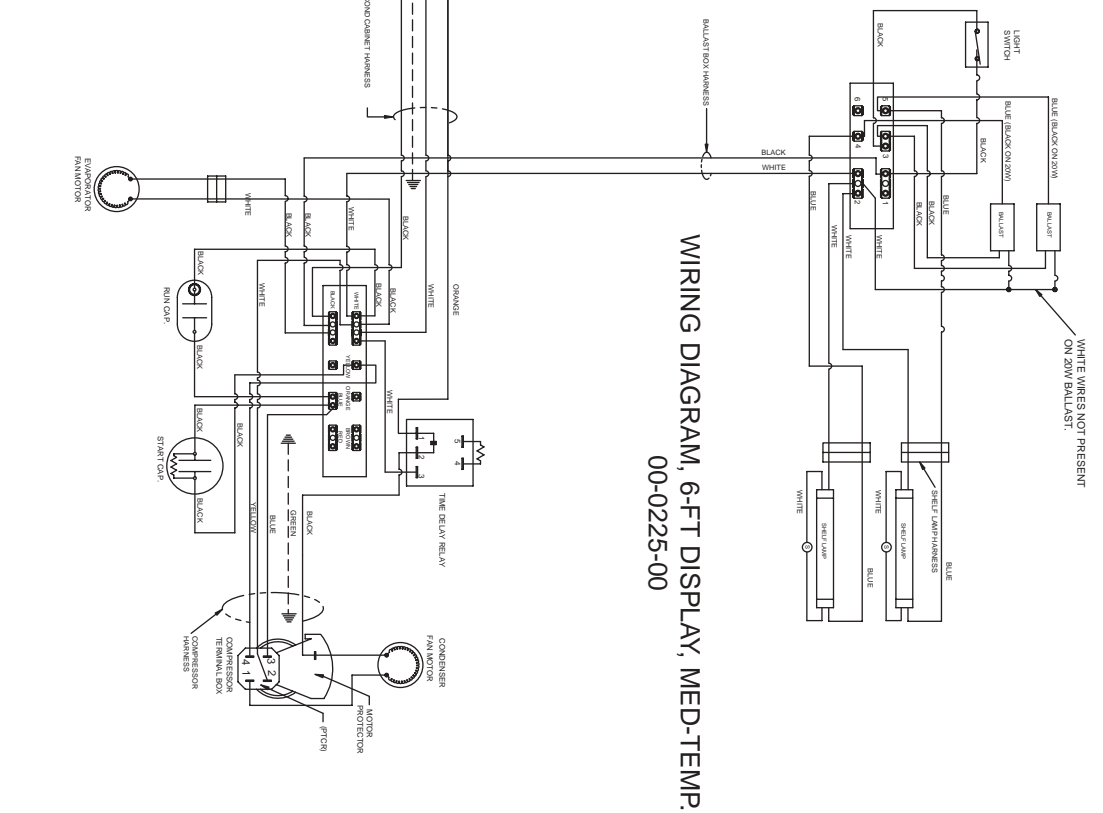

WIRING DIAGRAM, 6-FT DISPLAY, MED-TEMP.  
00-0225-00

# WIRING DIAGRAM – CDPD6, DPD6

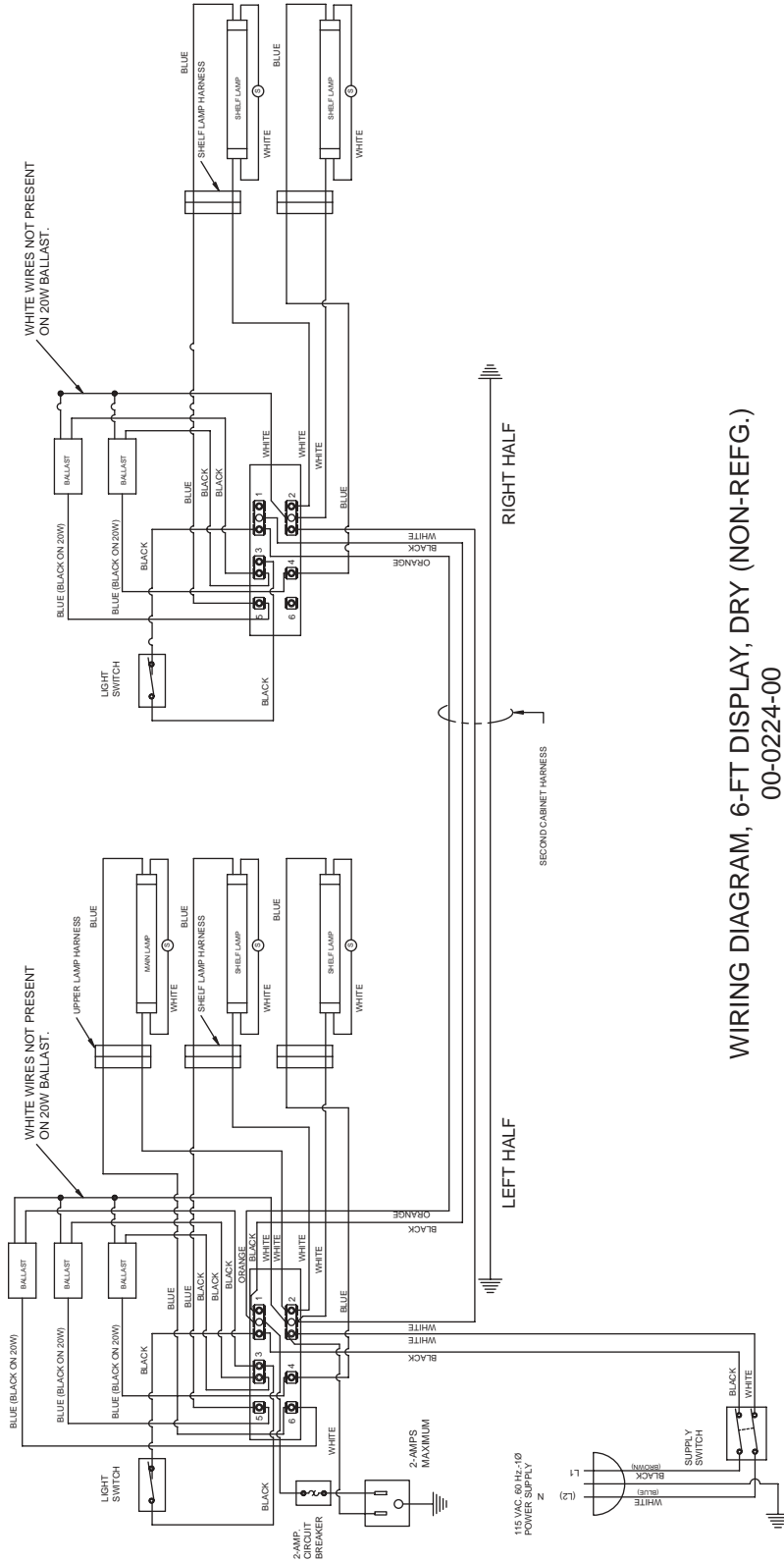

WIRING DIAGRAM, 6-FT DISPLAY, DRY (NON-REFG.)  
00-0224-00



# DIGITAL DISPLAY REMOVAL

In the event a display is to be replaced **DISCONNECT THE POWER SUPPLY TO THE CABINET.**

Insert a small screwdriver at one end of the bezel. Carefully pry out while working from one end to the other. The display can now be removed from the holder.

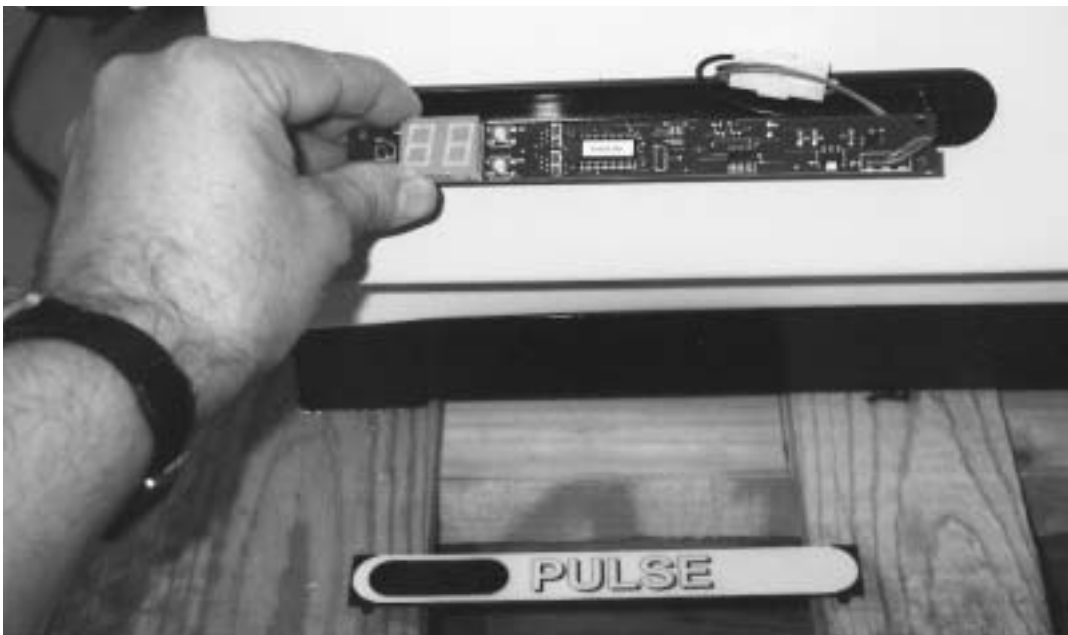

## ELECTRICAL BOX LAYOUT

The electrical box is located at the rear of the cabinet on the left-hand side.

It houses the compressor run components and the electronic control board.

A power switch is provided to shut the supply power off to the cabinet in the event service or cleaning is needed. The electrical box can be removed as an entire assembly by removing the two mounting screws in the lower base assembly if needed.



## CONTROL BOARD LAYOUT

1. 3 pin connector - Input cable from the display board.
2. 4 pin connector - Input cable from the cavity and evaporator coil inlet sensor.
3. Microchip (**DO NOT REMOVE**).
4. Dip switch selector (**DO NOT CHANGE FROM FACTORY SETTING**).
5. 9 pin connector - Power supply to the board.
6. Green LED light - Light blinking when power supply is turned on (indicates program running).
7. Relay #1 compressor.
8. Relay #2 not used.
9. Relay #3 Defrost Relay (low temp. models).
10. Relay #4 evap fan relay (low temp models).

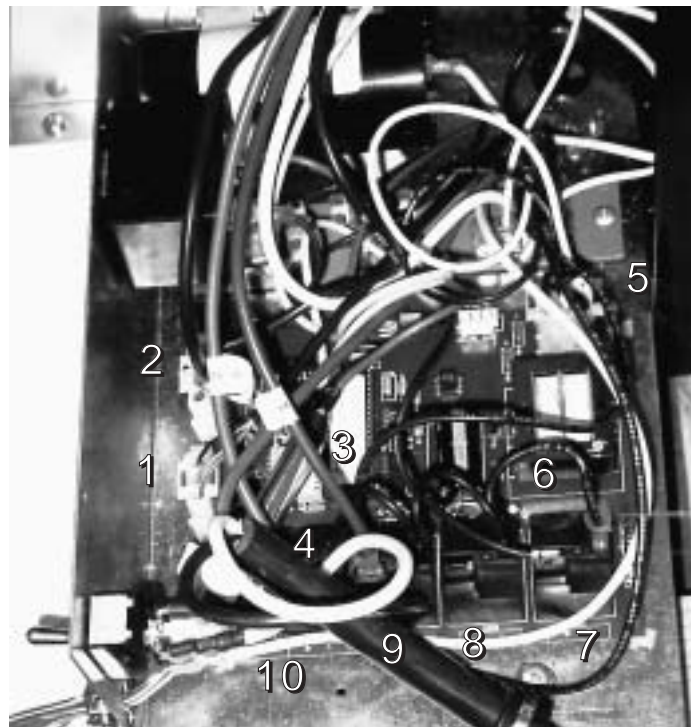

# EVAPORATOR AREA LAYOUT - Deck pan removed (low temp shown)

1. Cavity sensor lead  
(closed case low & med temp shown)
2. Evaporator fan motor
3. Evaporator air inlet
4. Evaporator air outlet
5. Captube outlet
6. Evaporator inlet sensor #2  
- med. & low temp models
7. High limit thermodisc (low temp)
8. Cavity sensor (medium open top models)

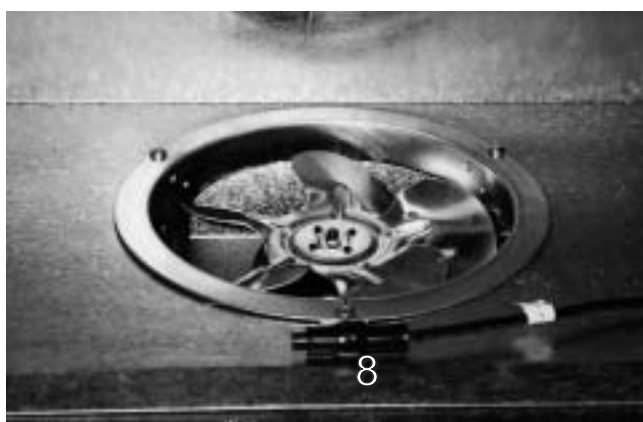
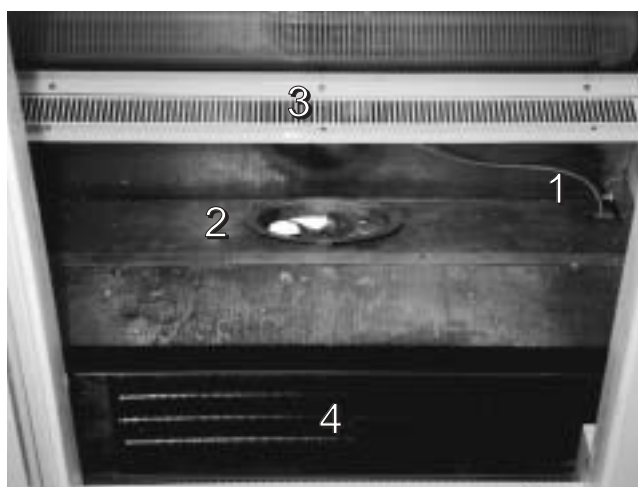

# EVAPORATOR COIL/DEFROST HEATER REMOVAL

Disconnect power supply to cabinet when servicing.  
The evaporator coil and or defrost heater can be removed by:

- Remove all shelving from cabinet
- Remove deck pan from cabinet
- Remove the evaporator fan shroud
- Locate and remove the coil air baffles (each end of coil)
- Remove the four coil housing cover screws located on each end of the coil.

This will allow the evaporator coil to be raised up and tilted forward for the removal of the coil or defrost heater. The defrost heater is held in place by spring retaining clips. A block of wood can be used to hold the coil up for the heater removal.



# WIRING & COMPONENT LOCATION

The wiring for these models are basically the same. Power supplied to the electrical box. It then branches in three separate circuits. Compressor harness, evaporator harness and lighting harness. The **evaporator harness (fig 1)** is not foamed in and can be replaced if necessary. It is routed from the electrical box up through a hole that enters just behind the evaporator coil (left-hand side). This bundle consists of two sensor leads and power supply to the defrost heater and evaporator fan motor (when applicable).



The **lighting harness** originates from the secondary terminal board located just above the rear unit compartment. This compartment houses the lighting ballast, auxilliary outlet with the circuit breaker and light switch.



The lighting harness supplies power in two ways:

- #1 circuit** to shelf lights and rear perimeter heaters'
- #2 circuit** to upper cavity light, front glass, front glass perimeter and upper lighting channel heater.

**CAUTION:** Make sure that the shelf light plugs or receptacle covers are completely inserted into the light socket receptacles. This prevents electrical arcing and or possible equipment damage.



**#3. Shelf light receptacles**

**#4. Rear perimeter heater raceway**



## Circuit #3

This circuit enters the foamed-in area behind the shelf lighting. The receptacle travels up to the **upper lighting receptacle #5** and power supply to **glass and perimeter heater #6 and #7**.



Access these connections by removing the top from the cabinet. Then pry up the galvanized subtop cover and lift out insulation. This will expose the wiring bundle (view shown with insulation removed).

## PERIMETER HEATER (Rear)

There is a separate perimeter heater for each door opening. The heater can be checked prior to changing by removing the rear ballast cover located just above the unit compartment. The perimeter heater harness is wired to this terminal board (double set of black and white wires) perimeter heaters are parallel at this point (fig 1).

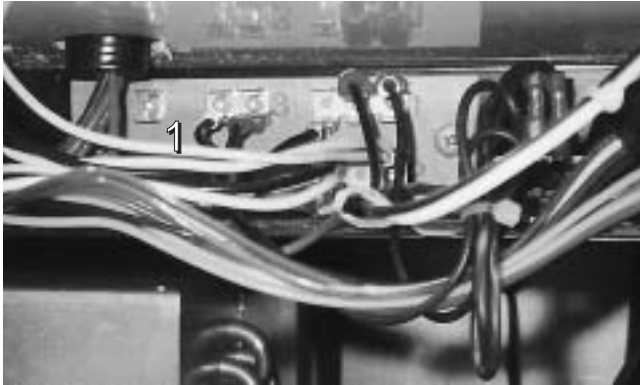

The perimeter heater can be individually checked by removing the perimeter harness cover located just below the inside door opening (View shown with cover removed).

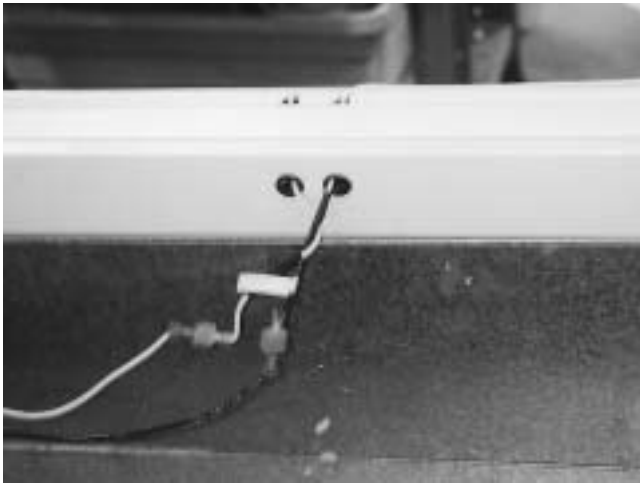

### LAMP COVER – FPD4, EFPD4, KFPD4, BRD52, EBRD52, KBRD62

To remove the lamp cover, loosen the thumbscrews, and slide the cover forward.

## DISCHARGE AIR OPENING (anti-sweat heater) Medium Temperature Open Models

The open view models have only one anti-sweat heater located just above the discharge air opening. To replace this heater simply remove the discharge air grill retaining bracket (upper s/s). Then lift the plastic grill up and out of the way. Fig 1.



The foil back heater is attached to a V shaped hat section as shown in Fig. 2. Reattach new heater and the galvanized hat section. Resecure the stainless steel grill retainer bracket.



## FPD CABINET SEALING

For improved performance and sealing under cabinet operating conditions, the corners of the cabinet are sealed with DOW 733. Side brackets with foam backing are attached to each end with nine (9) #8 stainless steel sheet metal screws to improve sealing of end panels to cabinet structure.



Left and Right Side Brackets  
PN 54044-135D-01  
with foam backing

# CONDENSING UNIT LAYOUT



**RPD Models 3' & 4'**



**FPD Models 3' & 4'**

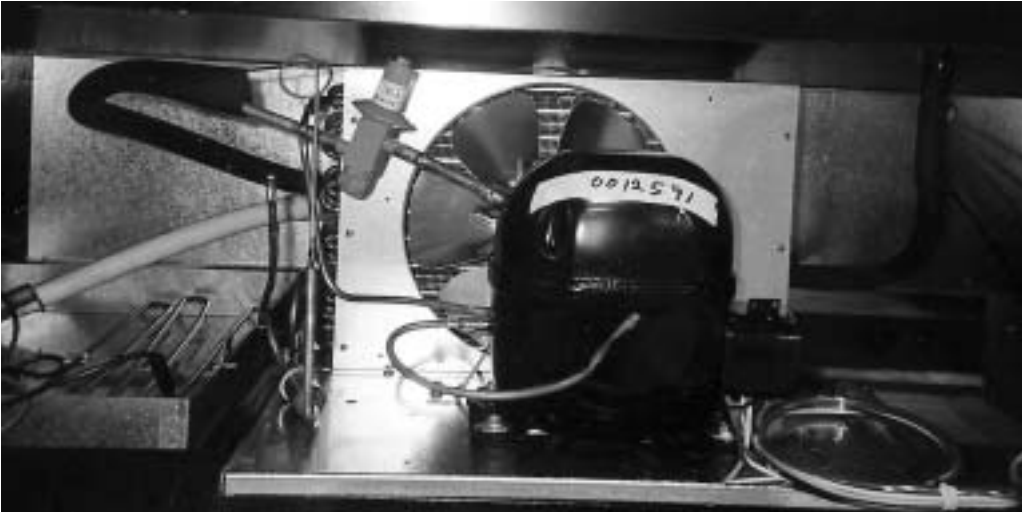

**OHM Models 3' & 4'**

NOTE: CRO valve setting 50#.

# PERIMETER HEATER REMOVAL

1. Disconnect power to cabinet.
2. Allow trim to warm up.
3. Insert the edge of the putty knife 1/16" under the outer flange of the trim breaker.
4. Rotate handle down to approximately 45°.
5. Bump the putty knife handle until breaker trim releases (see figure 1).
6. Remove all trim in the same manner.
7. Locate perimeter heater exit points.
8. Pull defective heater from grove provided.
9. The perimeter heater is plugged into a wire harness located just inside the cabinet behind the harness raceway.
10. Install new heater and reseal wire exit points.
11. Replace trim and seal with a silastic compound.



# DOOR REMOVAL(Rear)

## Aligning Doors

Proper alignment of the cabinet doors will eliminate hinge binding and provide correct gasket seal.

1. Check cabinet level and door alignment by firmly closing each door. Observe the movement of the other doors. They should open slightly, then close and seal.
2. The hinge has slotted mounting holes for adjustment.
3. Additional adjustment can be made by adding shims between the hinge wing and either the door or the cabinet face.

## Removing Doors:

1. Remove the hitch pin from the upper hinge pin.
2. Loosen lower hex nut (Nut "A") and release tension on the torsion rod.
3. Hold the door steady and unscrew the pin at top of the door. The door can now be lifted out of the lower hinge bracket.

## Door Gasket Removal:

Allow door to warm up to room temperature. At one corner simply pull the gasket out of the plastic groove provided. Replace new gasket by firmly pressing the rear dart of gasket into the plastic groove all the way around the door.



# GENERAL MAINTENANCE INFORMATION

## Cleaning & Maintenance

### **WARNING:**

To avoid the possibility of an electrical shock, turn OFF Master Supply Switch and unplug the electric cord of the cabinet before cleaning or touching electrical connections or parts.

## Cleaning the Cabinet Exterior

Wipe the exterior with a cloth dampened in mild detergent water; rinse and wipe dry with a soft, dry cloth. Do not use abrasive or caustic cleaners or scouring pads.

## Cleaning the Condenser

Periodic cleaning of the condenser can be easily accomplished by brushing the coils with a soft brush and/or using a vacuum cleaner with a brush attachment.

Be sure that dirt, dust and collection of other debris does not build up to a point air circulation through the condenser is restricted.

## Cleaning the Storage Compartment

Remove the product and store it in another suitable cabinet, if possible. Be sure to prevent spoilage of the product which may occur if it is left a room temperature.

Turn OFF the Master Supply Switch and unplug the cabinet.

Remove the shelving.

Wash the inside surface of the doors and the entire interior storage area with warm water and baking soda solution per quart of water. Rinse thoroughly with clean water and wipe dry. This procedure can also be used for cleaning the door gaskets.

### **IMPORTANT:**

Do not use any objects or cleaners which may leave residues, odors, or particles. Avoid the use of strong chemicals or abrasive cleaners which may damage the interior surfaces and contaminate produce within the storage area.

Wash, rinse and dry the shelving while it is outside of the cabinet, using the same procedure as described for the storage area.

Be sure to correctly reinstall the shelving, plug in the cabinet, turn ON the Master Supply Switch, set the Temperature Display, and allow time for the cooling of the storage area before storing product.

NOTE: If a spill occurs within the storage cabinet and any time the storage compartment is cleaned, removal and cleaning of the cabinet storage compartment components is possible as follows:

1. Shelving lifts off the shelf brackets as well as storage compartment bottom. Price tag moldings will slip off ends of shelves.
2. Shelf brackets will lift out of shelf standard slots when needed.
3. The shelf standards are attached to left, right, and center pillars in rear of storage compartment.



The shelves for the product area are shipped in place and lift out for cleaning.

Clean the cabinet exterior, interior, and shelving. Refer to "Cleaning the Cabinet Exterior" instructions in the Cleaning & Maintenance Section.

Plug the cabinet into the electrical outlet following the information in "Locating the Cabinet" instructions.

Electrical Supply— Cord Connected Cabinets

### **IMPORTANT**

Wiring and connection in power supply system must meet all applicable (local and national) electrical codes. Consult these codes for entire lengths and sizes prior to cabinet installation.

The wiring diagram should be consulted before attempting any electrical service. Be sure to turn OFF power supply to cabinet by turning OFF the Master Power Supply Switch and/or disconnecting power cord before performing electrical service.

# GENERAL MAINTENANCE INFORMATION-cont.

## WARNING

Failure to perform the installation and service procedures of the electrical system as described in the following instructions may result in a hazard to equipment operators and bystanders. Covers, guards, and connections of electrical components are designed for use safety and must always be reinstalled or returned to original manufactured condition after installation or service.

## IMPORTANT

If refrigeration system has trouble starting, maintaining correct temperature, or the cabinet lights dim, have the supply voltage checked by a licensed electrician: a.)with the cabinet disconnected; b.) under starting conditions, and c.) under load. Low line voltage is often the cause of a cabinet malfunction. Electrical supply requirements (see specifications label) should be consulted before installation and any time the cabinet is serviced.

### Maximum Fuse Size & Over-Current Protection:

Separately fused (or circuit breaker). Refer to serial data plate for correct circuit ampacity.

### Cabinet Power Supply Cord & Receptacle:

Grounded 3-Prong Plug, NEMA approved (National Electrical Manufacturers Association).

NOTE: Do not use an adapter or an extension cord with the power supply.

**Voltage Check:** Voltage at the compressor terminals must be within 10% (plus or minus) of rated voltage as compressor is starting up. If the voltage is not within this specified range, power supply (including wiring length and size) should be checked by a licensed electrician.

## Sliding Door Models

The cabinet doors are the sliding type. Each is spring loaded and will close automatically when opened and released. The spring assembly for each door runs through a channel in the top raceway. This assembly is attached to each respective door by a spring follower.

IMPORTANT: Keep bottom tracks clean for good door operation.

## Removing the Doors

To remove the right hand door, slide it a few inches to the left. Grasp the door firmly at the sides with both hands. Lift up slowly, and pull out at the bottom from the bottom raceway. Ease the door to the right to allow the nylon follower to rest at its stop. Do not let the spring snap.

To remove the left hand door, the right hand door must be taken out first. Move left door a few inches to the right and proceed by lifting up, pulling out at bottom, and easing to the left— allowing the spring follower to come to rest at its stop.

NOTE: To reinstall doors, use reverse procedure.

# COMPRESSOR – TROUBLESHOOTING CHARTS

<b>WON'T START. NO HUM..</b>	Open line circuit.	Check wiring, fuses, receptacle.
	Protector open.	Wait for reset—check current.
	Control contacts open.	Check control, check pressures.
<b>WON'T START. HUMS INTERMITTENTLY. (cycling on protector)</b>	Improperly wired.	Check wiring against diagram.
	Low line voltage.	Check main line voltage, determine location of voltage drop.
	Open starting capacitor.	Replace starting capacitor.
	Relay contacts not closing.	Check by operating manually. Replace relay if defective.
	Open circuit in start winding.	Check stator leads. If leads are all right, replace compressor.
	Stator winding grounded (normally will blow fuse.)	Check stator leads. If leads are all right replace compressor.
	High discharge pressure.	Eliminate cause of excessive pressure. Make sure discharge shut-off and receiver valves are open if applicable.
	Tight compressor.	Check oil level—correct binding condition, if possible. If not, replace compressor.
	Weak starting capacitor or one weak capacitor of a set.	Replace.
<b>COMPRESSOR STARTS - MOTOR WON'T GET OFF STARTING WINDING.</b>	Low line voltage.	Bring up voltage.
	Improperly wired.	Check wiring against diagram.
	Defective relay.	Check operation—replace relay if defective.
	Running capacitor shorted.	Check resistances. Replace capacitor if defective.
	Starting and running windings shorted.	Check capacitance - replace if defective.
	Starting capacitor weak or one of a set open.	Check capacitance. Replace if defective.
	High discharge pressure.	Check discharge shutoff valves. Check pressure.
	Tight compressor.	Check oil level. Check binding. Replace compressor if necessary.

# COMPRESSOR – TROUBLESHOOTING CHARTS

<b>COMPRESSOR STARTS &amp; RUNS BUT CYCLES ON PROTECTOR.</b>	Low line voltage.	Bring up voltage.
	Additional current passing through protector.	Check for added fan motors and pumps connected to wrong side of protector.
	Suction pressure too high.	Check compressor for proper application.
	Discharge pressure too high.	Check ventilation, restrictions and over-charge.
	Protector weak.	Check current - replace protector if defective.
	Running capacitor defective.	Check capacitance. Replace if defective.
	Stator partially shorted or grounded.	Check resistances; check for ground. Replace if defective.
	Inadequate motor cooling.	Correct cooling system.
	Compressor tight.	Check oil level. Check for binding condition.
	Unbalanced line (three-phase).	Check voltage of each phase. If not equal, correct condition of unbalance.
	Discharge valve leaking or broken.	Replace valve plate.
<b>STARTING CAPACITORS BURNT OUT.</b>	Short cycling.	Reduce number of starts to 20 or less per hour.
	Prolonged operation on starting winding.	Reduce starting load (install crankcase pressure limit valve), increase voltage if low—replace relay if defective.
	Relay contacts sticking.	Clean contacts or replace relay.
	Improper relay or incorrect relay setting.	Replace relay.
	Improper capacitor.	Check parts list for proper capacitor rating: mfd. and voltage.
<b>RUNNING CAPACITORS BURNT OUT.</b>	Excessive line voltage.	Reduce line voltage to not over 10% above rating of motor.
	High line voltage and light load.	Reduce voltage if over 10% excessive.
<b>RELAYS BURNT OUT.</b>	Low line voltage.	Increase voltage to not less than 10% above motor rating.
	Excessive line voltage.	Reduce voltage to not more than 10% above motor rating.
	Incorrect running capacitor.	Replace with correct capacitor.
	Short cycling.	Reduce number of starts per hour.
	Relay vibrating.	Mount relay rigidly.
	Incorrect relay.	Use relay recommended for specific motor compressor.

# FLUORESCENT LAMP TROUBLESHOOTING

The manufacturer uses standard fluorescent lamps in all of its applications. Standard one- and two-lamp ballast circuits are used.

Replacement lamps should be purchased over the counter from a local electrical wholesaler.

The table below indicates general problems that may be encountered with fluorescent lighting applications, possible causes, and corrective maintenance suggestions.

<b>NORMAL END OF LIFE.</b> Lamp won't operate. Flashes momentarily and goes out or blinks on and off. Ends probably blackened.	Normal failure. Active material on cathodes exhausted.	Replace lamp promptly.
<b>SHORT LIFE.</b>	Wrong lamp type used.	Replace with lamp type marked in owner's manual.
	Wrong type of starter.	Replace with correct starter.
	Ballast not supplying the specified electrical values.	Replace with correct ballast for rating for lamp size.
	Wrong type of ballast used.	Replace ballast with proper type.
	Too low or too high voltage.	Check primary voltage with range specified on ballast name plate.
	Poor circuit contact. (likely at lampholders.)	Lampholders should be rigidly mounted and lamp securely seated.
	Ballast improperly or incompletely connected.	Study ballast label wiring diagram and check connections.
	Too many lamp starts.	Average life for most lamps is dependent on number of starts and hours of operation.
<b>END BLACKENING.</b> Dense blackening at one end or both, extending 2"-3" from base.	Normal end of life.	Replace lamp promptly.
	Mercury deposit - generally within 1" of lamp end.	Should evaporate as lamp is operated.
	Poor circuit contact likely at the lampholder.	Lampholders should be rigidly mounted and lamp securely seated.
	Ballast improperly or incompletely connected.	Study ballast wiring instructions and check connections.
	Wrong type lamp used.	Replace with correct lamp type.
	Wrong type of starter or defective starter causing on/off blinking or prolonged flashing at each start.	Replace with proper starter.
	Ballast installed not supplying the specified electrical values.	Replace with ballast of correct rating for lamp size.
	Line voltage too low or too high.	Check line voltage with range specified on ballast plate.
	Ballast improperly or incompletely connected.	Study ballast label wiring instructions and check connections.

# FLUORSCENT LAMP TROUBLESHOOTING

<b>NORMAL END OF LIFE. NO STARTING EFFORT OR SLOW STARTING.</b>	Normal failure. Active material on Open lamp cathode circuit due to broken cathode, air leak, or by open weld. of light.	Replace lamp promptly. If open, circuit is shown by continuity test or viewing end of bulb against a pinhole Replace lamp.
	Wrong lamp type used.	Replace with lamp type indicated in owner's manual.
	Starter at end of life.	Replace starter.
	Starter sluggish.	Replace starter.
	Ballast installed not supplying the specified electrical values.	Replace with correct ballast of correct rating for lamp size.
	Temperature cold air contact to bulb.	Correct installation of lamp protection tubes, or shields to prevent cold air effects.
	Circuit voltage.	Check voltage and correct if possible.
<b>DECREASED LIGHT OUTPUT.</b> Full illumination of bulbs requires correct assembly of all components of lighting system.	Temperature operation, cold air affects lamp performance.	Properly install jacketed lamps where applicable.
	Circuit voltage.	Check voltage and correct if possible.
	Ballast improperly or incompletely connected.	Study ballast label wiring instructions and check connections.
	Dust or dirt on lamp or fixture.	Clean.
<b>BLINKING ON/OFF:</b> Accompanied by shimmering effect during "lighted" period.	Normal failure. Active material on cathodes exhausted.	Replace lamp promptly.
	Possible lamp fault in some lampholders.	Replace lamp. Investigate further if successive lamps blink or flicker during "lighted" period.
	Wrong type of starter or defective starter.	Replace with proper starter.
	Ballast installed not supplying the specified electrical circuit.	Replace with correct ballast with correct rating for lamp size.
	Circuit voltage.	Check voltage and correct if possible.
	Loose circuit contact.	Lampholders should be rigidly mounted and lamp securely seated.
<b>OVERHEATED BALLAST.</b>	Wrong lamp type used.	Replace with correct lamp number located in owner's manual.
	Wrong ballast used. Wrong voltage rating.	Replace ballast.
	Circuit voltage.	Check voltage and correct to design specifications.
	Ballast improperly or incompletely connected.	Study ballast label. Correct if installed wrong.

# COMPONENT IDENTIFICATION

## -Condensing Unit

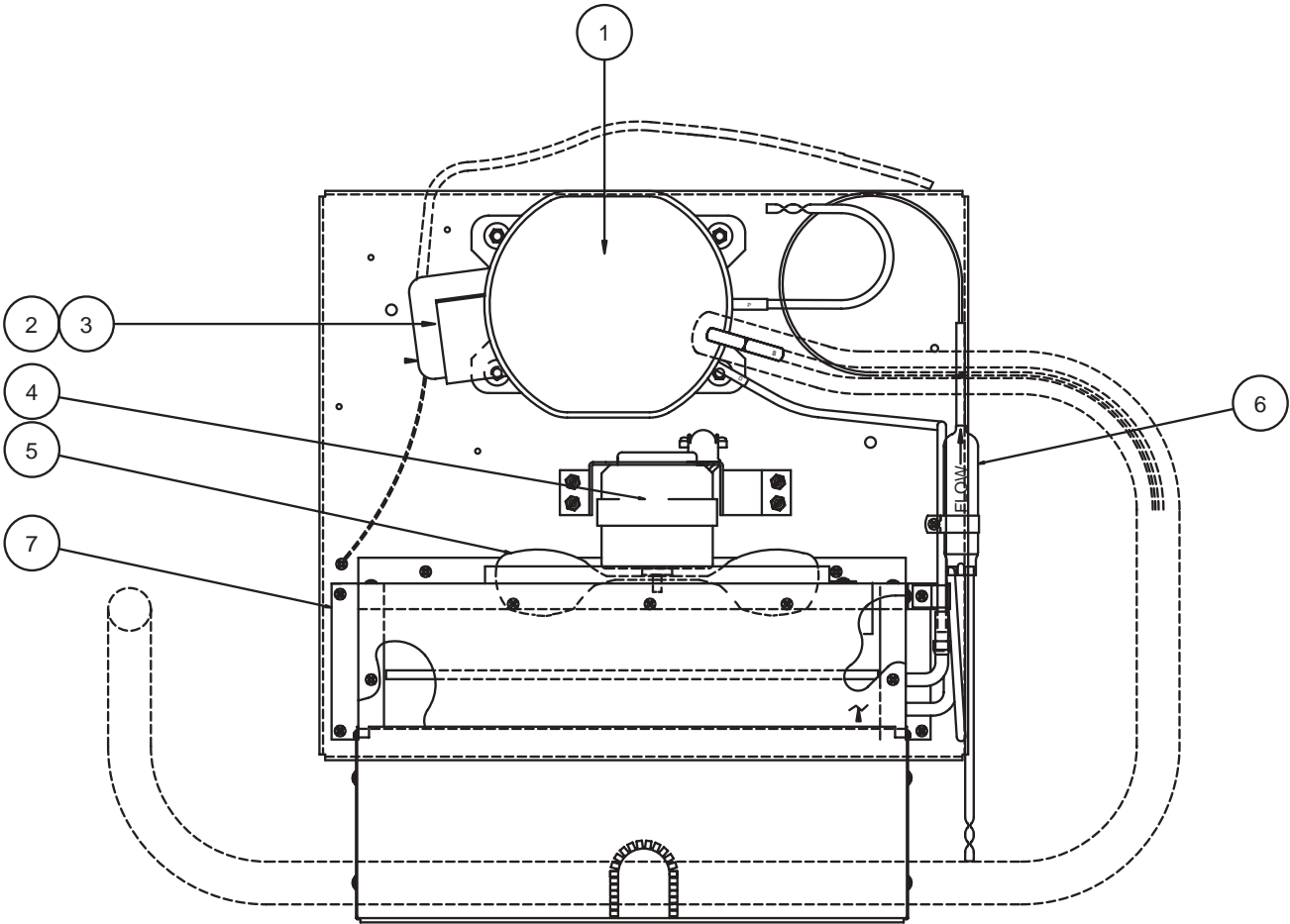

1	COMPRESSOR
2	MOTOR PROTECTOR
3	MOTOR STARTER
4	MOTOR
5	BLADE
6	DRIER
7	CONDENSER COIL

# COMPONENT IDENTIFICATION

## -Electrical Box Assembly

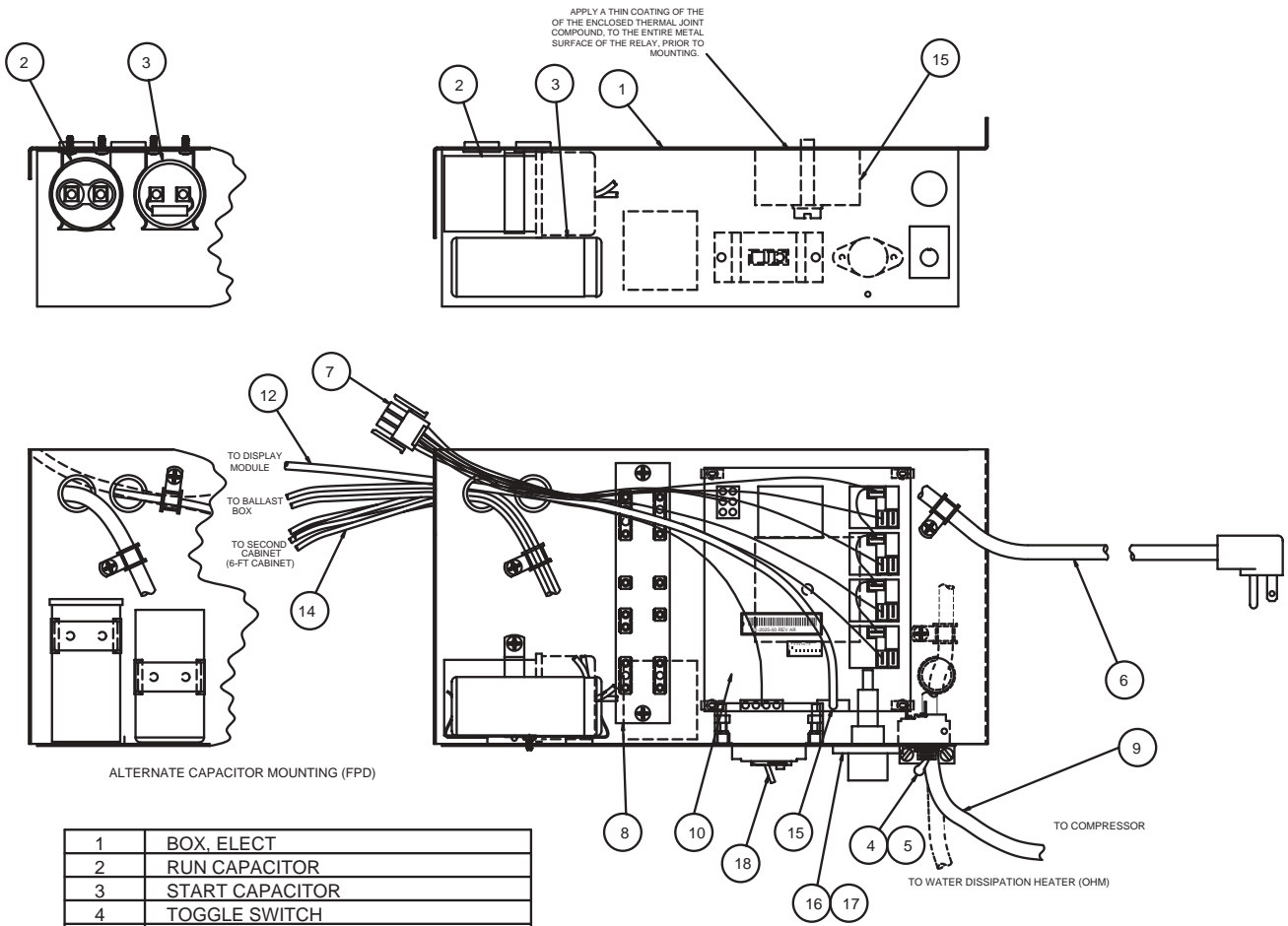

1	BOX, ELECT
2	RUN CAPACITOR
3	START CAPACITOR
4	TOGGLE SWITCH
5	ON/OFF INDICATOR PLATE
6	POWER CORD
7	HARNESS, ELECT BOX
8	BOARD, MAIN TERMINAL
9	COMPRESSOR HARNESS
10	CIRCUIT BOARD
11	HARNESS, EVAP FAN
12	HARNESS, DISPLAY
13	RELAY
14	HARNESS, SECOND CABINET
15	RELAY
16	FUSEHOLDER
17	FUSE
18	ELB ASSY

# COMPONENT IDENTIFICATION

## -Evaporator Area



# REPLACEMENT PARTS LIST

REPLACEMENT PARTS				MODEL NO.		MODEL NO.		MODEL NO.		MODEL NO.		MODEL NO.		MODEL NO.		MODEL NO.			
3FT Modular Merchandizers				CRPD3		RPD3		CDPD3		DPD3		CFPD3		FPD3		COHM3		OHM3	
PART NUMBER	DESCRIPTION	U/M	QTY	GR.#	QTY	GR.#	QTY	GR.#	QTY	GR.#	QTY	GR.#	QTY	GR.#	QTY	GR.#	QTY	GR.#	
16-0202-00	Compressor	EA									1	-	1	-					
16-0313-00	Compressor	EA	1	-	1	-									1	-	1	-	
17-0316-00	Protector	EA	1	-	1	-									1	-	1	-	
17-0300-00	Start Relay	EA	1	-	1	-									1	-	1	-	
17-0321-00	Start Relay	EA									1	-	1	-					
19-0933-00	Condenser Fan Motor	EA	1	-	1	-					1	-	1	-	1	-	1	-	
19-0101-00	Condenser Fan Blade	EA	1	-	1	-					1	-	1	-	1	-	1	-	
12-3024	Drier	EA	1	-	1	-					1	-	1	-	1	-	1	-	
18-1211-01	Condenser Coil	EA	1	-	1	-					1	-	1	-	1	-	1	-	
50-2170-*	Accordian Coil	EA	1	-02	1	-02					1	-01	1	-01	1	-03	1	-03	
18-0385-00	CRO Valve	EA													1	-	1	-	
17-0320-00	Run Capacitor	EA	1	-	1	-									1	-	1	-	
19-3024-00	Run Capacitor	EA									1	-	1	-					
17-0319-00	Start Capacitor	EA	1	-	1	-									1	-	1	-	
17-0325-00	Start Capacitor	EA									1	-	1	-					
19-0103-00	Supply Switch	EA	1	-	1	-	1	-	1	-	1	-	1	-	1	-	1	-	
19-0620-00	Service Cord	EA	1	-	1	-	1	-	1	-					1	-	1	-	
19-0967-00	Service Cord	EA									1	-	1	-					
19-1704-02	Circuit Board	EA	1	-	1	-					1	-	1	-	1	-	1	-	
18-0713-00	Evaporator Coil	EA									1	-	1	-	1	-	1	-	
18-0720-01	Evaporator Coil	EA	1	-	1	-													
19-0952-01	Evaporator Heater	EA									1	-	1	-					
19-1706-00	Defrost Limit	EA									1	-	1	-					
19-1156-01	Evaporator Fan Motor	EA	1	-	1	-					1	-	1	-	1	-	1	-	
19-1156-02	Evaporator Fan Blade	EA	1	-	1	-					1	-	1	-	1	-	1	-	
10-1450-01	Lower Front Panel	EA			1	-					1	-	1	-	1	-	1	-	
10-1451-01	Lower Front Panel	EA	1	-															
10-1452-01	Lower Front Panel	EA					1	-											
10-1441-01	Lower Front Panel	EA						1	-										
19-1705-01	Display Board	EA	1	-	1	-					1	-	1	-	1	-	1	-	
02-0291-01	Condensate Pan	EA	1	-	1	-					1	-	1	-	1	-	1	-	
19-1709-01	Condensate Pan Heater	EA													1	-	1	-	
10-1408-01	Rear Grill	EA	1	-	1	-	1	-	1	-	1	-	1	-	1	-	1	-	
51-1527-*	Sliding Doors w/Frame	EA	1	-01	1	-01	1	-03	1	-03									
51-2480-00	Rear Door	EA									1	-	1	-					
10-0234-00	Door Gasket	EA									1	-	1	-					
20-0084-01	Front Glass	EA						1	-										
20-0085-01	Front Glass	EA			1	-													
20-0086-01	Front Glass	EA											1	-					
20-0087-01	Front Glass	EA					1	-											
20-0088-01	Front Glass	EA	1	-															
20-0089-01	Front Glass	EA									1	-							
19-0957-01	Lamp Holder, Plunger	EA									3	-	1	-					
19-0957-02	Lamp Holder, Stationary	EA									3	-	1	-					
19-1975-00	Lamp Holder	EA	4	-	1	-	4	-	1	-									
19-0088-00	Lamp Holder w/St Socket	EA	4	-	1	-	4	-	1	-									
19-0144-00	Lamp Starter	EA	4	-	1	-	1	-	1	-									
19-0146-00	Ballast	EA	3	-	1	-	3	-	1	-									
19-1650-00	Ballast	EA									2	-	1	-					
19-0149-00	Lamp	EA	4	-	1	-	4	-	1	-									
19-3049-00	Lamp	EA									3	-	1	-					
10-0551-00	Safety Shield & End Cap	EA	4	-	1	-	4	-	1	-									
10-1446-00	Safety Shield & End Cap	EA									3	-	1	-					
19-0659-00	Light Switch	EA	1	-	1	-	1	-	1	-	1	-	1	-					
19-1047-00	Circuit Breaker	EA	1	-	1	-	1	-	1	-									
19-1319-01	Perimeter Heater, Front	EA									1	-	1	-					
19-1082-04	Perimeter Heater, Rear	EA									1	-	1	-					
19-1238-*	Anti-Sweat Heater	EA									1	-05	1	-05	1	-01	1	-01	
03-1231-03	Hinge, Upper Door, LH	EA									1	-	1	-					
03-1231-04	Hinge, Upper Door, RH	EA									1	-	1	-					
25-0413-00	Hinge Pin	EA									1	-	1	-					
05-0238-01	Shelf Panel, Top	EA	1	-	1	-	1	-	1	-	1	-	1	-					
05-0238-02	Shelf Panel, Middle	EA	1	-	1	-	1	-	1	-	1	-	1	-					
05-0259-01	Deck Pan, Bottom	EA	2	-	2	-	2	-	2	-	2	-	2	-					
05-0234-01	Deck Pan, Bottom	EA													1	-	1	-	
10-1422-01	Panel, Clear Front	EA													1	-	1	-	
10-1421-00	Panel, Clear Side	EA													2	-			
10-1423-00	Panel, Clear Side	EA															2	-	
50-0172-01	Step Weld Assembly	EA													1	-	1	-	

# REPLACEMENT PARTS LIST

REPLACEMENT PARTS 4FT Modular Merchandizers			MODEL NO.		MODEL NO.		MODEL NO.		MODEL NO.		MODEL NO.		MODEL NO.		MODEL NO.		MODEL NO.		MODEL NO.					
			CRPD4		RPD4		RPD4PT		CDPD4		DPD4		CFPD4		FPD4		BRD52		COHM4		OHM4			
PART NUMBER	DESCRIPTION	U/M	QTY	GR.#	QTY	GR.#	QTY	GR.#	QTY	GR.#	QTY	GR.#	QTY	GR.#	QTY	GR.#	QTY	GR.#	QTY	GR.#	QTY	GR.#		
16-0202-00	Compressor	EA																						
16-0313-00	Compressor	EA	1	-	1	-	1	-							1	-	1	-	1	-	1	-		
17-0316-00	Protector	EA	1	-	1	-	1	-												1	-	1	-	
17-0300-00	Start Relay	EA	1	-	1	-	1	-												1	-	1	-	
17-0321-00	Start Relay	EA													1	-	1	-	1	-				
19-0933-00	Condenser Fan Motor	EA	1	-	1	-	1	-							1	-	1	-	1	-	1	-	1	-
19-0101-00	Condenser Fan Blade	EA	1	-	1	-	1	-							1	-	1	-	1	-	1	-	1	-
12-3024	Drier	EA	1	-	1	-	1	-							1	-	1	-	1	-	1	-	1	-
18-1211-01	Condenser Coil	EA	1	-	1	-	1	-							1	-	1	-	1	-	1	-	1	-
50-2170-*	Accordian Coil	EA	1	-02	1	-02	1	-02							1	-01	1	-01	1	-01	1	-03	1	-03
18-0385-00	CRO Valve	EA																		1	-	1	-	
17-0320-00	Run Capacitor	EA	1	-	1	-	1	-												1	-	1	-	
19-3024-00	Run Capacitor	EA													1	-	1	-	1	-				
17-0319-00	Start Capacitor	EA	1	-	1	-	1	-												1	-	1	-	
17-0325-00	Start Capacitor	EA													1	-	1	-	1	-				
19-0103-00	Supply Switch	EA	1	-	1	-	1	-	1	-	1	-	1	-	1	-	1	-	1	-	1	-	1	-
19-0620-00	Service Cord	EA	1	-	1	-	1	-	1	-	1	-	1	-						1	-	1	-	
19-0967-00	Service Cord	EA													1	-	1	-	1	-				
19-1704-02	Circuit Board	EA	1	-	1	-	1	-							1	-	1	-	1	-	1	-	1	-
18-0714-01	Evaporator Coil	EA													1	-	1	-	1	-	1	-	1	-
18-0720-02	Evaporator Coil	EA	1	-	1	-	1	-							1	-	1	-	1	-	1	-	1	-
19-0952-03	Evaporator Heater	EA													1	-	1	-	1	-				
19-1706-00	Defrost Limit	EA													1	-	1	-	1	-				
19-1156-01	Evaporator Fan Motor	EA	1	-	1	-	1	-							1	-	1	-	1	-	1	-	1	-
19-1156-02	Evaporator Fan Blade	EA	1	-	1	-	1	-							1	-	1	-	1	-	1	-	1	-
10-1453-*	Lower Front Panel	EA			1	-01	1	-01							1	-01	1	-01	1	-06	1	-01	1	-01
10-1454-01	Lower Front Panel	EA	1	-																				
10-1455-01	Lower Front Panel	EA							1	-														
10-1442-01	Lower Front Panel	EA																						
19-1705-01	Display Board	EA	1	-	1	-	1	-							1	-	1	-	1	-	1	-	1	-
02-0291-02	Condensate Pan	EA	1	-	1	-	1	-							1	-	1	-	1	-	1	-	1	-
19-1709-01	Condensate Pan Heater	EA																		1	-	1	-	
10-1408-02	Rear Grill	EA	1	-	1	-	1	-	1	-	1	-	1	-	1	-	1	-	1	-	1	-	1	-
51-1527-*	Sliding Doors w/Frame	EA	1	-02	1	-02	2	-02	1	-04	1	-04												
51-1528-02	Sliding Door Frame, PT	EA					1	-																
51-2480-00	Rear Door	EA													2	-	2	-	2	-				
10-0234-00	Door Gasket	EA													2	-	2	-	2	-				
20-0084-02	Front Glass	EA													1	-	1	-	1	-				
20-0085-02	Front Glass	EA			1	-	1	-																
20-0086-02	Front Glass	EA													1	-	1	-	1	-				
20-0087-02	Front Glass	EA							1	-														
20-0088-02	Front Glass	EA	1	-																				
20-0089-02	Front Glass	EA													1	-	1	-	1	-				
19-0957-01	Lamp Holder, Plunger	EA													3	-	1	-	1	-				
19-0957-02	Lamp Holder, Stationary	EA													3	-	1	-	1	-				
19-1975-00	Lamp Holder	EA	4	-	1	-	1	-	4	-	1	-												
19-0088-00	Lamp Holder w/St Socket	EA	4	-	1	-	1	-	4	-	1	-												
19-0145-00	Lamp Starter	EA	1	-	1	-	1	-	1	-	1	-												
19-0458-00	Ballast	EA	4	-	4	-	4	-	4	-	4	-												
19-1725-00	Ballast	EA													3	-								
502-246B-01	Ballast	EA																		1	-	1	-	
19-0150-00	Lamp	EA	4	-	1	-	1	-	4	-	1	-												
19-3049-00	Lamp	EA													3	-								
503-249B	Lamp	EA																		1	-	1	-	
10-0308-00	Safety Shield & End Cap	EA	4	-	1	-	1	-	4	-	1	-												
713-062C-05	Safety Shield & End Cap	EA																		1	-	1	-	
10-1446-00	Safety Shield & End Cap	EA													3	-								
707-011D	Lamp Cover	EA																		1	-	1	-	
19-0659-00	Light Switch	EA	1	-	1	-	1	-	1	-	1	-	1	-	1	-	1	-	1	-				
19-1047-00	Circuit Breaker	EA	1	-	1	-	1	-	1	-	1	-												
19-1319-02	Perimeter Heater, Front	EA													1	-	1	-	1	-				
19-1082-04	Perimeter Heater, Rear	EA													1	-	1	-	1	-				
19-1238-*	Anti-Sweat Heater	EA	1	-06	1	-06	1	-06	1	-06	1	-06	1	-02	1	-02	1	-02	1	-02	1	-02	1	-02
03-1231-03	Hinge, Upper Door, LH	EA													2	-	2	-	2	-				
03-1231-04	Hinge, Upper Door, RH	EA													2	-	2	-	2	-				
25-0413-00	Hinge Pin	EA													2	-	2	-	2	-				
05-0238-03	Shelf Panel, Top	EA	1	-	1	-	1	-	1	-	1	-	1	-	1	-	1	-	1	-				
05-0238-04	Shelf Panel, Middle	EA	1	-	1	-	1	-	1	-	1	-	1	-	1	-	1	-	1	-				
51-1543-05	Glass Shelf Ass'y, Top	EA																		2	-			
51-1543-06	Glass Shelf Ass'y, Middle	EA																		2	-			
05-0259-02	Deck Pan, Bottom	EA	2	-	2	-	2	-	2	-	2	-	2	-	2	-	2	-	2	-				
01-0250-02	Deck Pan, Bottom	EA																		2	-			
05-0234-02	Deck Pan, Bottom	EA																			1	-	1	-
10-1422-02	Panel, Clear Front	EA																			1	-	1	-
10-1421-00	Panel, Clear Side	EA																						

# REPLACEMENT PARTS LIST

REPLACEMENT PARTS				MODEL NO.		MODEL NO.		MODEL NO.		MODEL NO.		MODEL NO.		MODEL NO.		
6FT Modular Merchandizers				CRPD6		RPD6		CDPD6		DPD6		COHM6		OHM6		
PART NUMBER	DESCRIPTION	U/M	QTY	GR.#	QTY	GR.#	QTY	GR.#	QTY	GR.#	QTY	GR.#	QTY	GR.#	QTY	GR.#
16-0313-00	Compressor	EA	2	-	2	-					2	-	2	-		
17-0316-00	Protector	EA	2	-	2	-					2	-	2	-		
17-0300-00	Start Relay	EA	2	-	2	-					2	-	2	-		
19-0933-00	Condenser Fan Motor	EA	2	-	2	-					2	-	2	-		
19-0101-00	Condenser Fan Blade	EA	2	-	2	-					2	-	2	-		
12-3024	Drier	EA	2	-	2	-					2	-	2	-		
18-1211-01	Condenser Coil	EA	2	-	2	-					2	-	2	-		
50-2170-*	Accordian Coil	EA	2	-02	2	-02					2	-03	2	-03		
17-0320-00	Run Capacitor	EA	2	-	2	-					2	-	2	-		
17-0319-00	Start Capacitor	EA	2	-	2	-					2	-	2	-		
19-1343-00	Relay, Time Delay	EA	1	-	1	-					1	-	1	-		
19-1345-00	Resistor, 47k, Time Delay	EA	1	-	1	-					1	-	1	-		
19-0103-00	Supply Switch	EA	1	-	1	-	1	-	1	-	1	-	1	-		
19-0620-00	Service Cord	EA					1	-	1	-						
19-0967-00	Service Cord	EA	1	-	1	-					1	-	1	-		
19-1704-02	Circuit Board	EA	1	-	1	-					1	-	1	-		
18-0713-00	Evaporator Coil	EA									2	-	2	-		
18-0720-01	Evaporator Coil	EA	2	-	2	-										
19-1156-01	Evaporator Fan Motor	EA	2	-	2	-					2	-	2	-		
19-1156-02	Evaporator Fan Blade	EA	2	-	2	-					2	-	2	-		
10-1450-01	Lower Front Panel	EA			1	-					1	-	1	-		
10-1451-01	Lower Front Panel	EA	1	-												
10-1452-01	Lower Front Panel	EA	1	-			2	-								
10-1441-01	Lower Front Panel	EA			1	-			2	-	1	-	1	-		
19-1705-01	Display Board	EA	1	-	1	-					1	-	1	-		
02-0291-01	Condensate Pan	EA	1	-	1	-					2	-	2	-		
19-1709-01	Condensate Pan Heater	EA									2	-	2	-		
10-1408-01	Rear Grill	EA	2	-	2	-	2	-	2	-	2	-	2	-		
20-0084-03	Front Glass	EA							1	-						
20-0085-03	Front Glass	EA			1	-										
20-0087-03	Front Glass	EA					1	-								
20-0088-03	Front Glass	EA	1	-												
19-1975-00	Lamp Holder	EA	5	-	1	-	5	-	1	-						
19-0088-00	Lamp Holder w/St Socket	EA	5	-	1	-	5	-	1	-						
19-0144-00	Lamp Starter	EA	4	-			4	-								
19-0145-00	Lamp Starter	EA	1	-	1	-	1	-	1	-						
19-0146-00	Ballast	EA	4	-			4	-								
19-0458-00	Ballast	EA	1	-	1	-	1	-	1	-						
19-0149-00	Lamp	EA	4	-			4	-								
19-0151-00	Lamp	EA	1	-	1	-	1	-	1	-						
10-0551-00	Safety Shield & End Cap	EA	4	-			4	-								
10-0445-00	Safety Shield & End Cap	EA	1	-	1	-	1	-	1	-						
19-0659-00	Light Switch	EA	1	-	1	-	1	-	1	-						
19-1238-01	Anti-Sweat Heater	EA									2	-	2	-		
05-0238-01	Shelf Panel, Top	EA	2	-	2	-	2	-	2	-						
05-0238-02	Shelf Panel, Middle	EA	2	-	2	-	2	-	2	-						
05-0259-01	Deck Pan, Bottom	EA	4	-	4	-	4	-	4	-						
05-0234-01	Deck Pan, Bottom	EA									2	-	2	-		
10-1422-03	Panel, Clear Front	EA									1	-	1	-		
10-1421-00	Panel, Clear Side	EA									2	-				
10-1422-00	Panel, Clear Side	EA												2	-	
50-0172-01	Step Weld Assembly	EA									2	-	2	-		

# REPLACEMENT PARTS LIST

REPLACEMENT PARTS				MODEL NO.		MODEL NO.		MODEL NO.		MODEL NO.		MODEL NO.		MODEL NO.		MODEL NO.		MODEL NO.	
Export Modular Merchandizers				ECFPD4		EFPD4		EBRD52		KCFPD4		KCFPD4C		KFPD4		KFPD4C		KBRD52	
PART NUMBER	DESCRIPTION	U/M	QTY	GR.#	QTY	GR.#	QTY	GR.#	QTY	GR.#	QTY	GR.#	QTY	GR.#	QTY	GR.#	QTY	GR.#	
16-0330-00	Compressor	EA							1	-	1	-	1	-	1	-	1	-	
16-0331-00	Compressor	EA	1	-	1	-	1	-											
17-0327-00	Start Relay	EA	1	-	1	-	1	-											
19-0540-00	Start Relay	EA						1	-	1	-	1	-	1	-	1	-		
19-0934-00	Condenser Fan Motor	EA	1	-	1	-	1	-	1	-	1	-	1	-	1	-	1	-	
19-0101-00	Condenser Fan Blade	EA	1	-	1	-	1	-	1	-	1	-	1	-	1	-	1	-	
12-3024	Drier	EA	1	-	1	-	1	-	1	-	1	-	1	-	1	-	1	-	
18-1211-01	Condenser Coil	EA	1	-	1	-	1	-	1	-	1	-	1	-	1	-	1	-	
50-2170-*	Accordian Coil	EA	1	-01	1	-01	1	-01	1	-01	1	-01	1	-01	1	-01	1	-01	
17-0295-00	Run Capacitor	EA	1	-	1	-	1	-											
19-2678-00	Run Capacitor	EA						1	-	1	-	1	-	1	-	1	-		
17-0326-00	Start Capacitor	EA	1	-	1	-	1	-											
19-2666-00	Start Capacitor	EA						1	-	1	-	1	-	1	-	1	-		
19-0103-00	Supply Switch	EA	1	-	1	-	1	-	1	-	1	-	1	-	1	-	1	-	
19-1349-00	Service Cord	EA	1	-	1	-	1	-	1	-			1	-			1	-	
19-1350-00	Service Cord	EA								1	-			1	-				
19-1704-02	Circuit Board	EA	1	-	1	-	1	-	1	-	1	-	1	-	1	-	1	-	
18-0714-01	Evaporator Coil	EA	1	-	1	-	1	-	1	-	1	-	1	-	1	-	1	-	
19-0952-02	Evaporator Heater	EA	1	-	1	-	1	-	1	-	1	-	1	-	1	-	1	-	
19-1706-00	Defrost Limit	EA	1	-	1	-	1	-	1	-	1	-	1	-	1	-	1	-	
19-1201-00	Evaporator Fan	EA	1	-	1	-	1	-	1	-	1	-	1	-	1	-	1	-	
10-1453-*	Lower Front Panel	EA	1	-01	1	-01	1	-06	1	-01	1	-01	1	-01	1	-01	1	-06	
19-1705-01	Display Board	EA	1	-	1	-	1	-	1	-	1	-	1	-	1	-	1	-	
02-0291-02	Condensate Pan	EA	1	-	1	-	1	-	1	-	1	-	1	-	1	-	1	-	
10-1408-02	Rear Grill	EA	1	-	1	-	1	-	1	-	1	-	1	-	1	-	1	-	
51-2480-00	Rear Door	EA	2	-	2	-	2	-	2	-	2	-	2	-	2	-	2	-	
10-0234-00	Door Gasket	EA	2	-	2	-	2	-	2	-	2	-	2	-	2	-	2	-	
20-0086-04	Front Glass	EA			1	-	1	-					1	-	1	-	1	-	
20-0089-04	Front Glass	EA	1	-				1	-	1	-								
19-0957-01	Lamp Holder, Plunger	EA	1	-	1	-	1	-	1	-	1	-	1	-	1	-	1	-	
19-0957-02	Lamp Holder, Stationary	EA	1	-	1	-	1	-	1	-	1	-	1	-	1	-	1	-	
19-1346-00	Transformer, Ballast	EA	1	-	1	-	1	-	1	-	1	-	1	-	1	-	1	-	
19-1725-00	Ballast	EA	1	-				1	-	1	-								
502-246B-01	Ballast	EA			1	-	1	-					1	-	1	-	1	-	
19-3049-00	Lamp	EA	1	-				1	-	1	-								
503-249B	Lamp	EA			1	-	1	-					1	-	1	-	1	-	
10-1446-00	Safety Shield & End Cap	EA	1	-				1	-	1	-								
713-062C-05	Safety Shield & End Cap	EA			1	-	1	-					1	-	1	-	1	-	
707-011D	Lamp Cover	EA			1	-	1	-					1	-	1	-	1	-	
19-0659-00	Light Switch	EA	1	-	1	-	1	-	1	-	1	-	1	-	1	-	1	-	
19-1348-00	Circuit Breaker	EA								1	-			1	-				
19-1347-02	Fuse, 15A	EA								1	-			1	-				
24-0498	Fuse, Holder	EA								1	-			1	-				
19-1319-04	Perimeter Heater, Front	EA	1	-	1	-	1	-	1	-	1	-	1	-	1	-	1	-	
19-1082-05	Perimeter Heater, Rear	EA	2	-	2	-	2	-	2	-	2	-	2	-	2	-	2	-	
19-1238-07	Anti-Sweat Heater	EA	1	-	1	-	1	-	1	-	1	-	1	-	1	-	1	-	
03-1231-03	Hinge, Upper Door, LH	EA	2	-	2	-	2	-	2	-	2	-	2	-	2	-	2	-	
03-1231-04	Hinge, Upper Door, RH	EA	2	-	2	-	2	-	2	-	2	-	2	-	2	-	2	-	
25-0413-00	Hinge Pin	EA	2	-	2	-	2	-	2	-	2	-	2	-	2	-	2	-	
05-0238-03	Shelf Panel, Top	EA	1	-	1	-			1	-	1	-	1	-	1	-			
05-0238-04	Shelf Panel, Middle	EA	1	-	1	-			1	-	1	-	1	-	1	-			
51-1543-05	Glass Shelf Ass'y, Top	EA					2	-									2	-	
51-1543-06	Glass Shelf Ass'y, Middle	EA					2	-									2	-	
05-0259-02	Deck Pan, Bottom	EA	2	-	2	-			2	-	2	-	2	-	2	-			
01-0250-02	Deck Pan, Bottom	EA					2	-									2	-	



CARRIER COMMERCIAL REFRIGERATION, INC.

Providing BEVERAGE-AIR • FRIGIDAIRE • KELVINATOR • UNIVERSAL NOLIN Products/Services  
P.O. Box 5932

Spartanburg, S.C. 29304-5932 • (800) 684-1199