

LINE VOLTAGE
220V/50Hz/1Ph
SEE NAMEPLATE FOR MAXIMUM
FUSE SIZE

TERMINAL
BLOCK

L

N

G

BROWN

BLUE

GRN-YEL

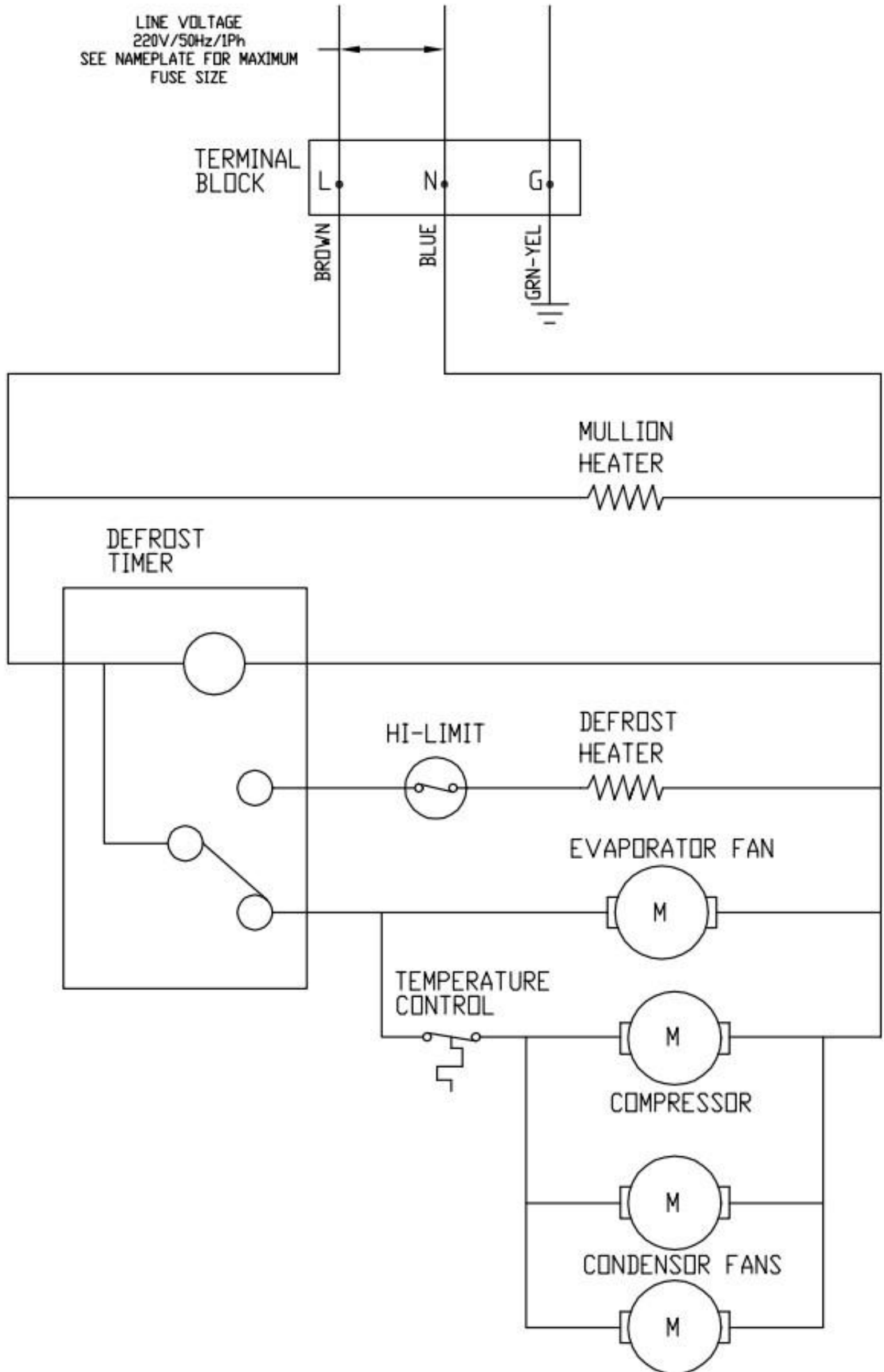

LINE VOLTAGE
220V/50Hz/1Ph
SEE NAMEPLATE FOR MAXIMUM
FUSE SIZE

TERMINAL
BLOCK

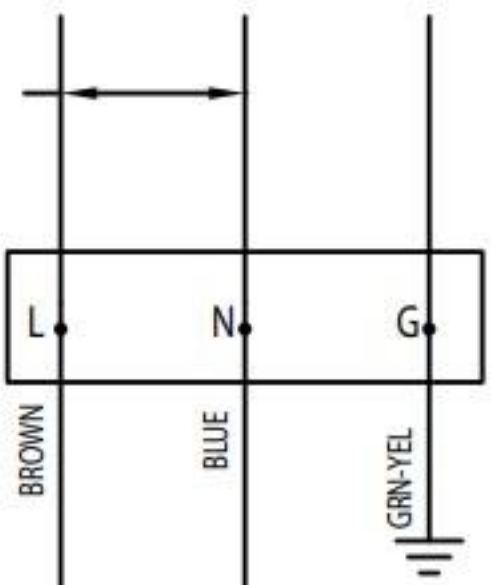

TEMPERATURE
CONTROL

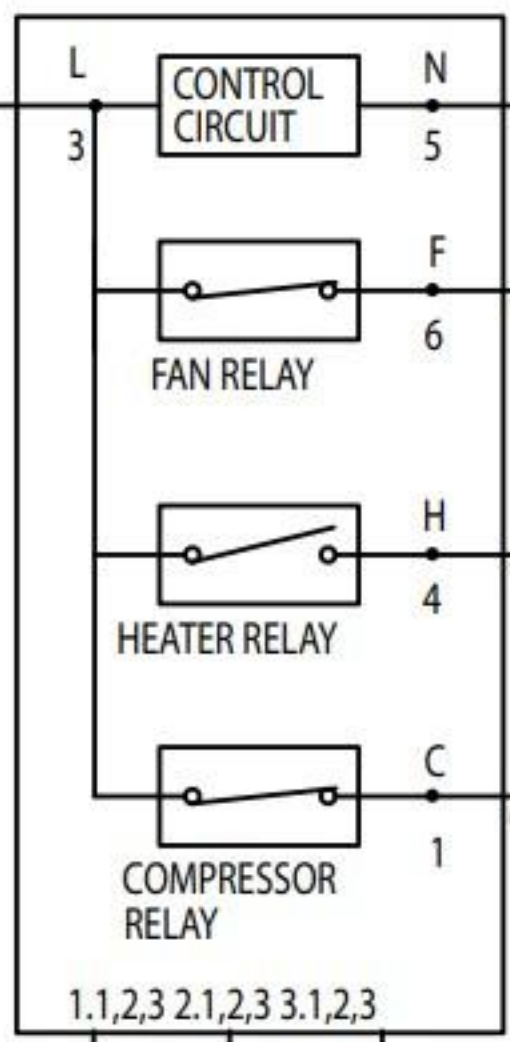

LED DISPLAY
(IF USED)

EVAP COIL
SENSOR

CABINET AIR
SENSOR

EVAPORATOR FAN

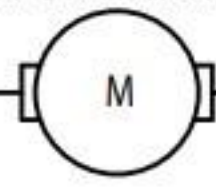

HI-LIMIT

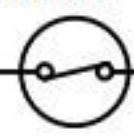

DEFROST
HEATER

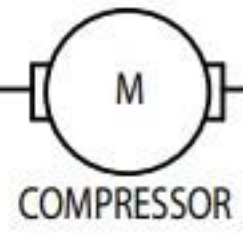

COMPRESSOR

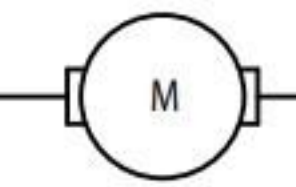

CONDENSOR FAN

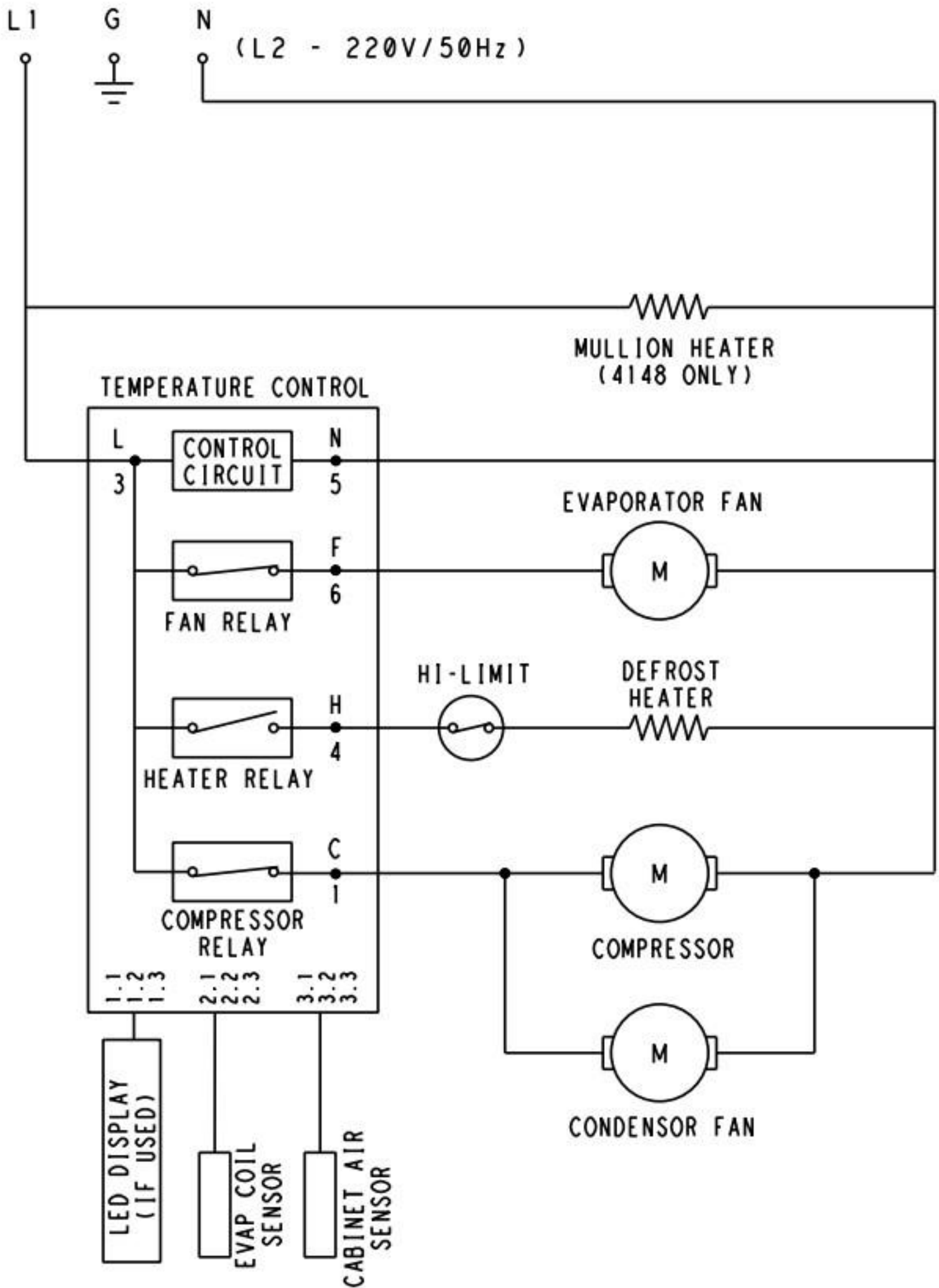

LINE VOLTAGE
220V/50Hz/1Ph
SEE NAMEPLATE FOR MAXIMUM
FUSE SIZE

TERMINAL
BLOCK

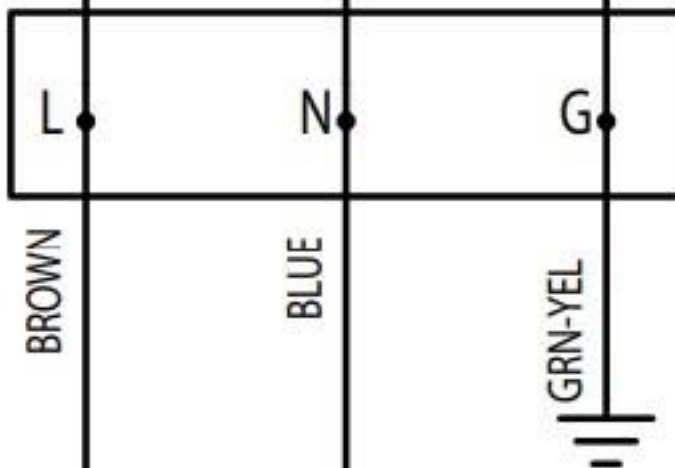

BROWN

BLUE

GRN-YEL

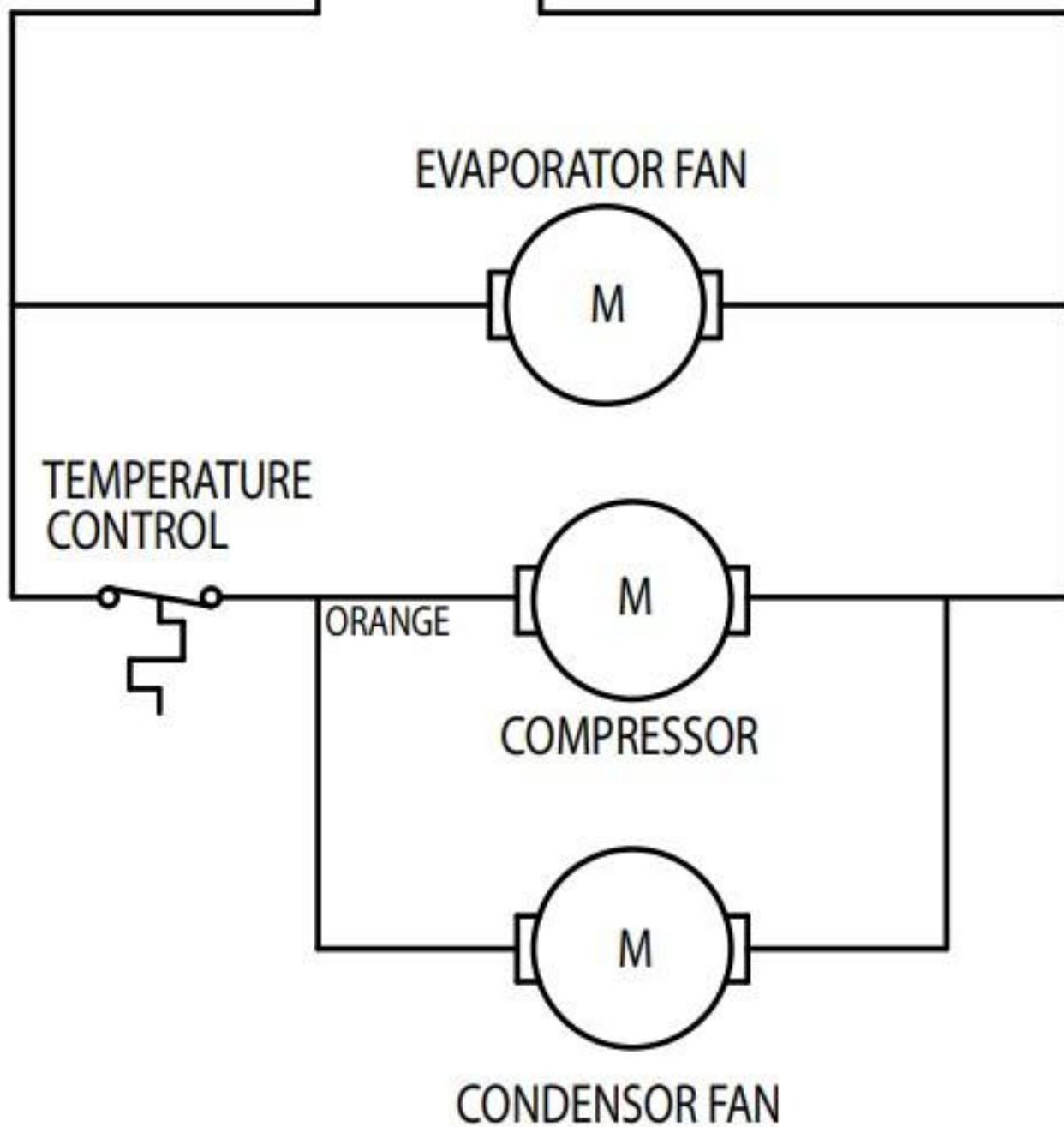

EVAPORATOR FAN

M

TEMPERATURE
CONTROL

ORANGE

M

COMPRESSOR

M

CONDENSOR FAN

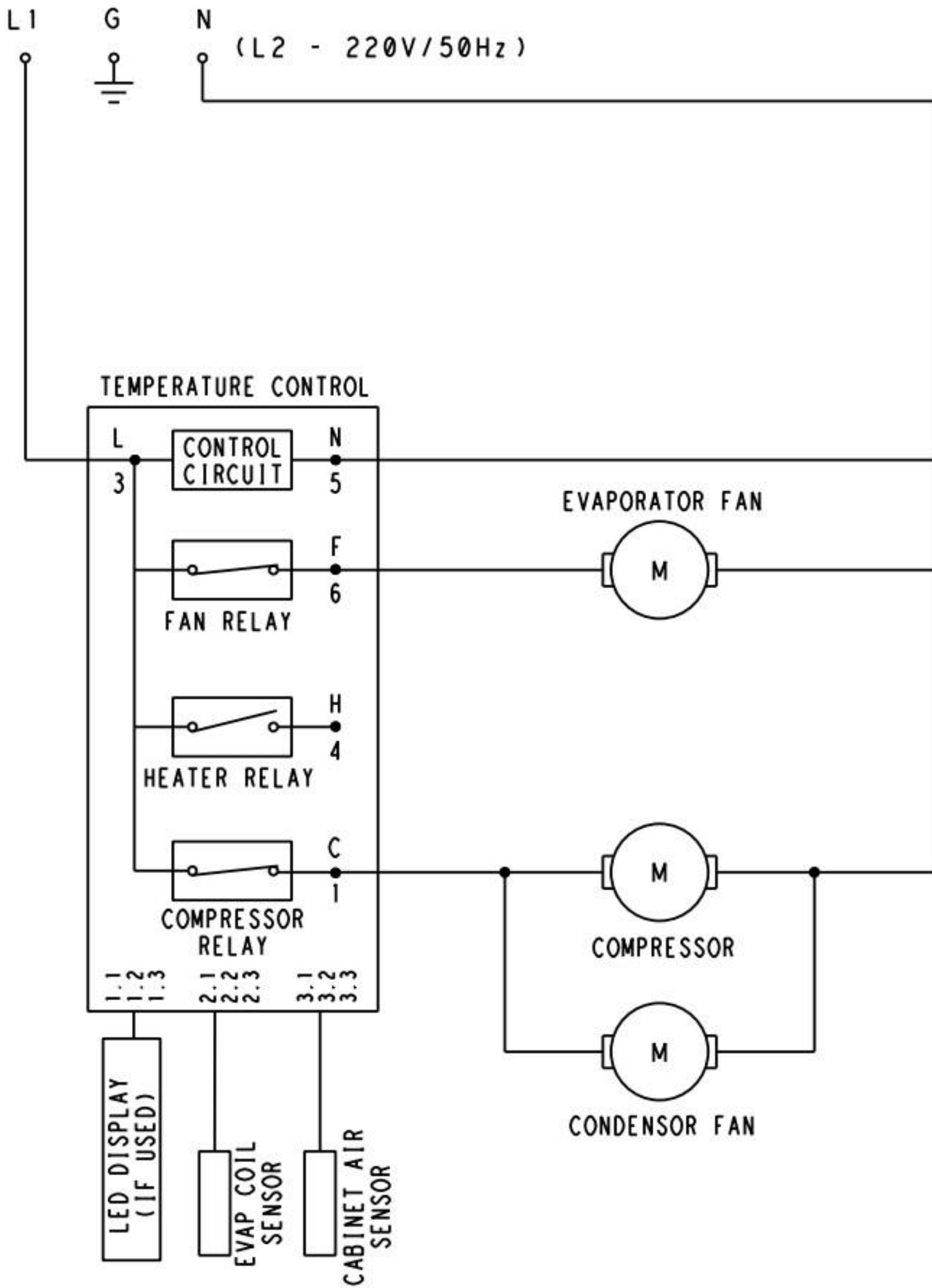

115V/60Hz/1Ø

L1 G N

NEMA 5-15P
Supply Cord &
Plug Furnished

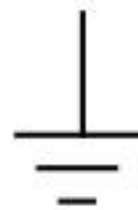

Black

White

