

Series GU Work Tables

CoolScapes™

Original Instructions

Installation, Operation and Maintenance Manual

This manual is updated as new information and models are released. Visit our website for the latest manual.



Safety Notices

⚠ Warning

Read this manual thoroughly before operating, installing or performing maintenance on the equipment. Failure to follow instructions in this manual can cause property damage, injury or death.

⚠ DANGER

Do not install or operate equipment that has been misused, abused, neglected, damaged, or altered/modified from that of original manufactured specifications.

⚠ DANGER

Keep power cord AWAY from HEATED surfaces. DO NOT immerse power cord or plug in water. DO NOT let power cord hang over edge of table or counter.

⚠ DANGER

All utility connections and fixtures must be maintained in accordance with Local and national codes.

⚠ Warning

Authorized Service Representatives are obligated to follow industry standard safety procedures, including, but not limited to, local/national regulations for disconnection / lock out / tag out procedures for all utilities including electric, gas, water and steam.

⚠ Warning

Do not store or use gasoline or other flammable vapors or liquids in the vicinity of this or any other appliance. Never use flammable oil soaked cloths or combustible cleaning solutions, for cleaning.

⚠ Warning

This product contains chemicals known to the State of California to cause cancer and/or birth defects or other reproductive harm. Operation, installation, and servicing of this product could expose you to airborne particles of glasswool or ceramic fibers, crystalline silica, and/or carbon monoxide. Inhalation of airborne particles of glasswool or ceramic fibers is known to the State of California to cause cancer. Inhalation of carbon monoxide is known to the State of California to cause birth defects or other reproductive harm.

⚠ Warning

Do not use electrical appliances or accessories other than those supplied by the manufacturer.

⚠ Warning

Use caution when handling metal surface edges of all equipment.

⚠ Warning

This appliance is not intended for use by persons (including children) with reduced physical, sensory or mental capabilities, or lack of experience and knowledge, unless they have been given supervision concerning use of the appliance by a person responsible for their safety. Do not allow children to play with this appliance.

⚠ Caution

Use caution handling, moving and use of the R290 refrigerators to avoid either damaging the refrigerant tubing or increasing the risk of a leak. Components shall be replaced with like components. Servicing shall be done by a factory authorized service personnel to minimize the risk of possible ignition due to incorrect parts or improper service.

Notice

Proper installation, care and maintenance are essential for maximum performance and trouble-free operation of your equipment. Visit our website www.mtwkitchencare.com for manual updates, translations, or contact information for service agents in your area.

Table of Contents

Section 1

General Information

Model Numbers	5
Serial Number Information	5
Warranty Information	5
Regulatory Certifications	5

Section 2

Installation

Location	6
Weight of Equipment	7
Clearance Requirements.....	7
Dimensions	7
Electrical Service	8
Ground Fault Circuit Interrupter	8
Rated Amperages, Horsepower, Voltage & Power Cord Chart.....	9
Drain Connections.....	10
Refrigeration	10
Leveling.....	10
Stabilizing.....	10
Leg & Caster Installation.....	10
Optional Overshelf Installation Instructions	11
32" GUC Optional Tray Slide	12

Section 3

Operation

R290 Controls/Programming/Settings.....	13
R290 Temperature Control & Display	14
R290 Evaporator Fan Operation.....	15
Changing Display from Fahrenheit to Celsius on ERC112 Control	16

Section 4

Maintenance

Cleaning and Sanitizing Procedures.....	17
General.....	17
Interior Cleaning.....	18
Preventing Blower Coil Corrosion	18
Exterior Cleaning.....	18
Drain.....	19
Cleaning the Condenser Coil	19
Casters.....	19
Doors/Hinges.....	19
Drawer Removal For Cleaning	20
Drawer Cleaning	20
Door Hinges	21

Section 5

Troubleshooting

Problem -> Cause -> Correction Chart.....	23
---	----

THIS PAGE INTENTIONALLY LEFT BLANK

Section 1

General Information

Model Numbers

This manual covers the following models:

Work Top Refrigerator		
Stainless Steel Door	Glass Door	Drawers
GUR24(B)P-S	GUR24(B)P-G	GUR24(B)P-D
GUR27(B)P-S	GUR27(B)P-G	GUR27(B)P-D
GUR32(B)P-S	GUR32(B)P-G	GUR32(B)P-D
GUR48(B)P-S	GUR48(B)P-G	GUR48(B)P-D
GUR60(B)P-S	GUR60(B)P-G	GUR60(B)P-D
GUR72(B)P-S	GUR72(B)P-G	GUR72(B)P-D

Work Top Freezer	
Stainless Steel Door	Drawers
GUF27(B)P-S	GUF27(B)P-D
GUF32(B)P-S	GUF32(B)P-D
GUF48(B)P-S	NA
GUF60(B)P-S	GUF60(B)P-D

Serial Number Information

The serial number is on the identification plate that also includes the model number. The identification plate is located near the top front corner of the left interior wall.

Always have the serial number of your unit available when calling for parts or service.



Warranty Information

Visit www.delfield.com/warranty to:

- Register your product for warranty.
- Verify warranty information.
- View and download a copy of your warranty.

Regulatory Certifications

All models are certified by:

-  National Sanitation Foundation (NSF)
-  Underwriters Laboratories (UL)
-  Underwriters Laboratories of Canada (cUL)

Section 2 Installation

⚠ DANGER

Installation must comply with all applicable fire and health codes in your jurisdiction.

⚠ DANGER

Use appropriate safety equipment during installation and servicing.

⚠ Warning

Do not damage the refrigeration circuit when installing, maintaining or servicing the unit.

Location

⚠ Warning

This equipment must be positioned so that the plug is accessible unless other means for disconnection from the power supply (e.g., circuit breaker or disconnect switch) is provided.

⚠ Warning

Adequate means must be provided to limit the movement of this appliance without depending on or transmitting stress to the electrical conduit or gas lines.

⚠ Warning

To avoid instability the installation area must be capable of supporting the combined weight of the equipment and product. Additionally the equipment must be level side to side and front to back.

⚠ Warning

This equipment is intended for indoor use only. Do not install or operate this equipment in outdoor areas.

The location selected for the equipment must meet the following criteria. If any of these criteria are not met, select another location.

- The location **MUST** be level, stable and capable of supporting the weight of the equipment.
- The location **MUST** be free from and clear of combustible materials.
- Equipment **MUST** be level both front to back and side to side.
- Position the equipment so it will not tip or slide.
- Front casters **MUST** be locked once positioned.
- Recommended air temperature is 50° - 100°F (10° - 38°C).
- Proper air supply for ventilation is **REQUIRED AND CRITICAL** for safe and efficient operation.
- Do not obstruct the flow of ventilation air. Make sure the air vents of the equipment are not blocked.
- Do not install the equipment directly over a drain. Steam rising up out of the drain will adversely affect operation, air circulation, and damage electrical / electronic components.

Weight of Equipment

Description	Model	Weight
24" Refrigerator	GUR24(B)P-S, GUR24(B)P-G	140 lbs (64kg)
	GUR24(B)P-D	162 lbs (73kg)
27" Refrigerator	GUR27(B)P-S, GUR27(B)P-G	145 lbs (66kg)
	GUR27(B)P-D	168 lbs (76kg)
32" Refrigerator	GUR32(B)P-S, GUR32(B)P-G	161 lbs (73kg)
	GUR32(B)P-D	185 lbs (84kg)
48" Refrigerator	GUR48(B)P-S, GUR48(B)P-G	207 lbs (94kg)
	GUR48(B)P-D	252 lbs (114kg)
60" Refrigerator	GUR60(B)P-S, GUR60(B)P-G	234 lbs (106kg)
	GUR60(B)P-D	284 lbs (129kg)
72" Refrigerator	GUR72(B)P-S, GUR72(B)P-G	263 lbs (119kg)
	GUR72(B)P-D	330 lbs (150kg)
27" Freezer	GUF27(B)P-S	151 lbs (68kg)
	GUF27(B)P-D	175lbs (79kg)
32" Freezer	GUF32(B)P-S	165 lbs (75kg)
	GUF32(B)P-D	189 lbs (86kg)
48" Freezer	GUF48(B)P-S	224 lbs (102kg)
60" Freezer	GUF60(B)P-S	250 lbs (113kg)
	GUF60(B)P-D	300 lbs (136kg)

Clearance Requirements

- Keep the vents clean and free of obstruction.
- Casters or optional legs must be used and not removed.

Dimensions

Models	Length	Depth	Work Height with		
			5" Casters or Feet	3" Casters	2" Casters
GUR24(B)P-S, GUR24(B)P-G, GUR24(B)P-D	24.00" (61cm)	31.50" (80cm)	36.00" (91cm)	33.88" (86cm)	31.88" (81cm)
GUR27(B)P-S, GUR27(B)P-G, GUR27(B)P-D	27.00" (69cm)				
GUR32(B)P-S, GUR32(B)P-G, GUR32(B)P-D	32.00" (81cm)				
GUR48(B)P-S, GUR48(B)P-G, GUR48(B)P-D	48.00" (122cm)				
GUR60(B)P-S, GUR60(B)P-G, GUR60(B)P-D	60.00" (152cm)				
GUR72(B)P-S, GUR72(B)P-G, GUR72(B)P-D	72.00" (183cm)				
GUF27(B)P-S, GUF27(B)P-D					
GUF32(B)P-S, GUF32(B)P-D					
GUF48(B)P-S					
GUF60(B)P-S, GUF60(B)P-D					
GUF72(B)P-S, GUF72(B)P-D					

Units with a backsplash have a B in the model number. The backsplash doesn't change the work height but adds 4.00" (10cm) to the overall height.

Work Top with Door Models		
Refrigerator	Freezer	Volume
GUR24(B)P-S, GUR24(B)P-G	NA	4.1 ft ³ (116 L)
GUR27(B)P-S, GUR27(B)P-G	GUF27(B)P-S	4.8 ft ³ (136 L)
GUR32(B)P-S, GUR32(B)P-G	GUF32(B)P-S	5.8 ft ³ (164 L)
GUR48(B)P-S, GUR48(B)P-G	GUF48(B)P-S	9.2 ft ³ (261 L)
GUR60(B)P-S, GUR60(B)P-G	GUF60(B)P-S	11.7 ft ³ (331 L)
GUR72(B)P-S, GUR72(B)P-G	NA	14.2 ft ³ (402 L)
Work Top with Drawers Models		
Refrigerator	Freezer	Quantity of 1/6 Size x 6" Deep Pans
GUR24(B)P-D	NA	8
GUR27(B)P-D	GUF27(B)P-D	12
GUR32(B)P-D	GUF32(B)P-D	12
GUR48(B)P-D	NA	16
GUR60(B)P-D	GUF60(B)P-D	24
GUR72(B)P-D	NA	24

Electrical Service

DANGER

Check all wiring connections, including factory terminals, before operation. Connections can become loose during shipment and installation.

Warning

This appliance must be grounded and all field wiring must conform to all applicable local and national codes. Refer to rating plate for proper voltage. It is the responsibility of the end user to provide the disconnect means to satisfy the authority having jurisdiction.

- Plug units with R290 refrigerant into a receptacle that is a minimum of 14" (36cm) above the floor.
- All electrical work, including wire routing and grounding, must conform to local, state and national electrical codes.
- The equipment must be grounded.
- A separate fuse/circuit breaker must be provided for each unit.
- The maximum allowable voltage variation is $\pm 10\%$ of the rated voltage at equipment start-up (when the electrical load is highest).
- Check all green ground screws, cables and wire connections to verify they are tight before start-up.

GROUND FAULT CIRCUIT INTERRUPTER

Ground Fault Circuit Interrupter (GFCI/GFI) protection is a system that shuts down the electric circuit (opens it) when it senses an unexpected loss of power, presumably to ground. Welbilt does not recommend the use of GFCI/GFI circuit protection to energize our equipment. If code requires the use of a GFCI/GFI then you must follow the local code. The circuit must be dedicated, sized properly and there must be a panel GFCI/GFI breaker. We do not recommend the use of GFCI/GFI outlets to energize our equipment as they are known for more intermittent nuisance trips than panel breakers.

RATED AMPERAGES, HORSEPOWER, VOLTAGE & POWER CORD CHART

Maximum 8ft (2.4m) cord with plug.

Model	Amps	HP	Voltage, Cycle, Phase	NEMA Plug
GUR24(B)P-S, GUR24(B)P-G, GUR24(B)P-D	3.2	1/5	115V, 60Hz, 1Ph	5-15P
GUR27(B)P-S, GUR27(B)P-G, GUR27(B)P-D	3.2	1/5	115V, 60Hz, 1Ph	5-15P
GUF27(B)P-S, GUF27(B)P-D	2.6	1/4	115V, 60Hz, 1Ph	5-15P
GUR32(B)P-S, GUR32(B)P-G, GUR32(B)P-D	3.2	1/5	115V, 60Hz, 1Ph	5-15P
GUF32(B)P-S, GUF32(B)P-D	2.6	1/4	115V, 60Hz, 1Ph	5-15P
GUR48(B)P-S, GUR48(B)P-G, GUR48(B)P-D	3.2	1/5	115V, 60Hz, 1Ph	5-15P
GUF48(B)P-S	6.4	1/3	115V, 60Hz, 1Ph	5-15P
GUR60(B)P-S, GUR60(B)P-G, GUR60(B)P-D	3.2	1/5	115V, 60Hz, 1Ph	5-15P
GUF60(B)P-S, GUF60(B)P-D	6.4	1/3	115V, 60Hz, 1Ph	5-15P
GUR72(B)P-S, GUR72(B)P-G, GUR72(B)P-D	3.2	1/5	115V, 60Hz, 1Ph	5-15P

Drain Connections

⚠ Warning

Moisture collecting from improper drainage can create a slippery surface on the floor and a hazard to employees. It is the owner's responsibility to provide a container or outlet for drainage.

Refrigeration

Model	BTU/Hour Capacity	Heat of Rejection	Charge
GUR24(B)P-S	270	147	78g
GUR24(B)P-G	300	185	78g
GUR24(B)P-D	320	173	78g
GUR27(B)P-S	280	157	78g
GUR27(B)P-G	330	195	78g
GUR27(B)P-D	320	186	78g
GUF27(B)P-S	400	291	62g
GUF27(B)P-D	560	410	62g
GUR32(B)P-S	310	172	78g
GUR32(B)P-G	360	210	78g
GUR32(B)P-D	360	208	78g
GUF32(B)P-S	450	325	62g
GUF32(B)P-D	640	466	62g
GUR48(B)P-S	470	270	78g
GUR48(B)P-G	560	346	78g
GUR48(B)P-D	560	325	78g
GUF48(B)P-S	680	479	111g
GUR60(B)P-S	530	307	78g
GUR60(B)P-G	630	383	78g
GUR60(B)P-D	630	377	78g
GUF60(B)P-S	790	559	111g
GUF60(B)P-D	1140	831	111g
GUR72(B)P-S	630	365	78g
GUR72(B)P-G	780	479	78g
GUR72(B)P-D	740	449	78g

Leveling

After the cabinet has been placed in the desired location, cabinets with legs must be leveled. Level units from front to back and from side to side. Leveling will insure proper door operation and removal of condensate. Cabinets with casters must have the caster brake set so the cabinet cannot move.

Stabilizing

It is very important that all legs are properly adjusted to keep the cabinet level, evenly distribute the weight and to make sure the unit will not rock, lean or be unstable.

Leg & Caster Installation

⚠ DANGER

Legs or casters must be installed and the legs or casters must be screwed in completely to prevent bending. When casters are installed the mass of this unit will allow it to move uncontrolled on an inclined surface. These units must be tethered/secured to comply with all applicable codes.

⚠ Warning

The unit must be installed in a stable condition with the front wheels locked. Locking the front casters after installation is the owner's and operator's responsibility.

⚠ Warning

Use a jack to lift the refrigeration unit off the ground just far enough to remove the leg/caster. Place blocking underneath the unit. Do not work underneath a raised unit without proper blocking. Do not lift the unit more than necessary to remove the leg/caster. Lifting the unit too far can make the unit unstable.

⚠ Caution

All single-section units require that the swivel casters be mounted on the front and rigid casters be mounted on the rear.

To install the legs or casters:

1. Remove unit from skid.
2. Raise unit to access leg/caster mounting holes on bottom of unit.
3. Attach the legs or casters to bottom of cabinet using hex head bolts.

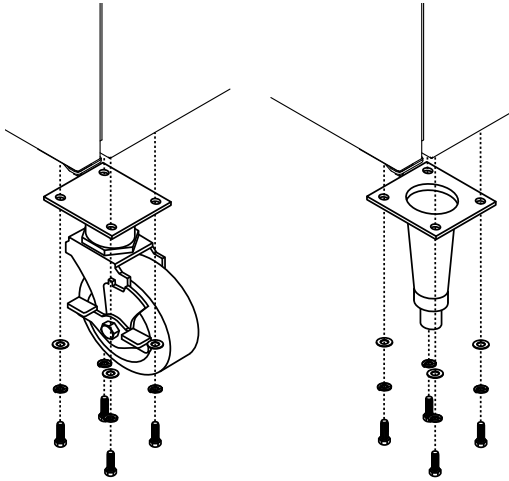

4. *This last step applies only to single section units with 2" casters. While the unit is raised, mount an air divider on the bottom. It runs front to back down the center and has two holes for mounting.*

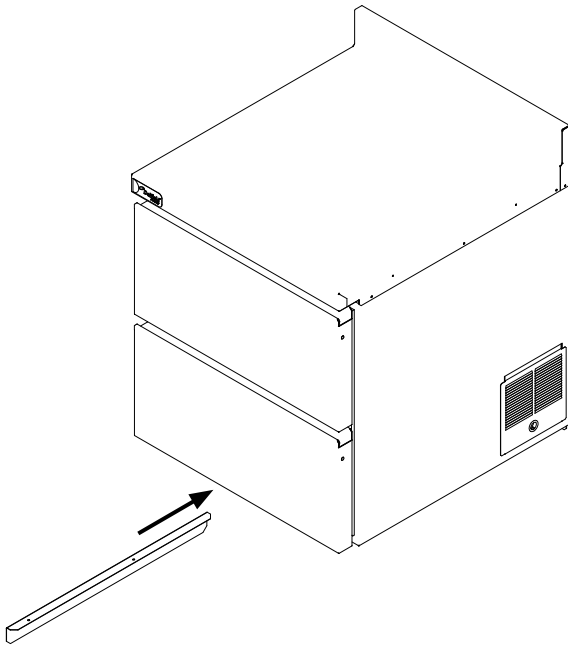
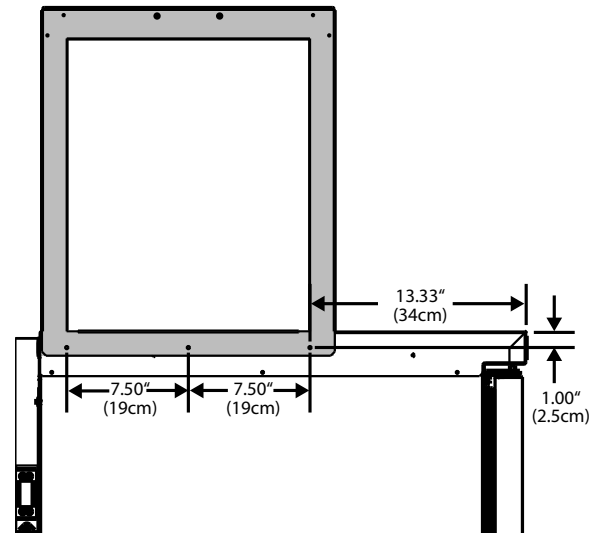
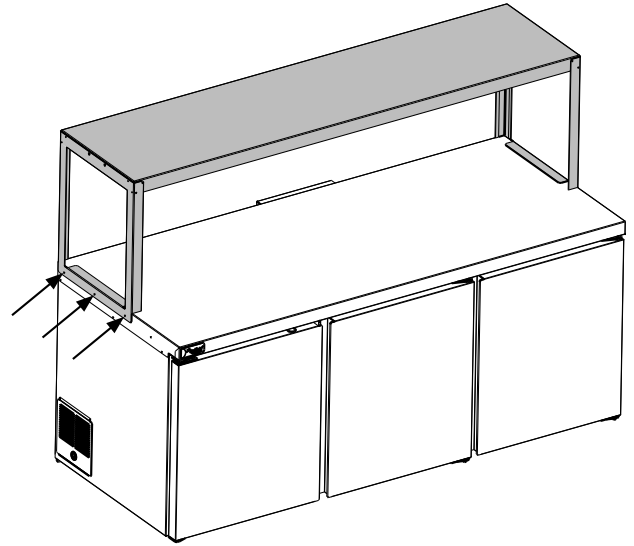
**Optional Overshelf Installation Instructions****If the unit is ordered to have the overshelf:**

1. Remove the three screws from each top side of the cabinet (total six screws).
2. Set the overshelf in-place on the top of the cabinet.
3. Line up the three overshelf holes with the unit holes.
4. Secure with three screws per side of the cabinet (total six screws).

If the overshelf was not ordered with the unit:

1. Set the overshelf in-place on the top of the cabinet.
2. Secure with three screws per side of the cabinet (total six screws).

32" GUC Optional Tray Slide

1. Remove pilasters. Retain thumb screws for tray slide installation.
2. Orient the rack with the stop flange at the back. The bottom slide is not as long as the others.

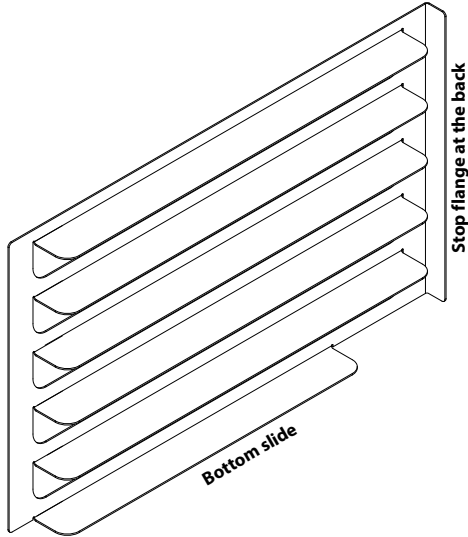

3. Install rack sides into existing holes inside the unit with thumb screws.

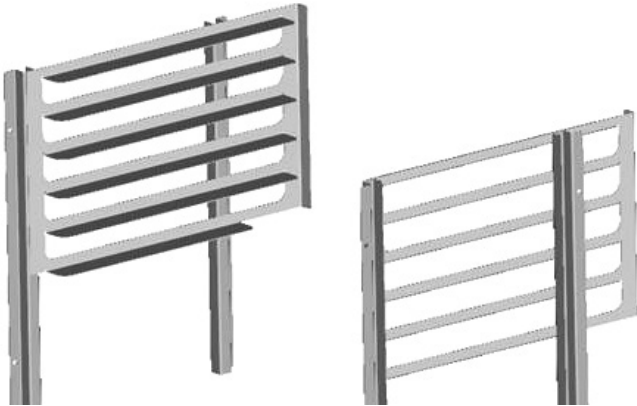

Section 3 Operation

⚠ DANGER

Do not operate any appliance with a damaged cord or plug. All repairs must be performed by a qualified service company.

⚠ DANGER

Never stand on the unit! They are not designed to hold the weight of an adult, and may collapse or tip if misused in this manner.

⚠ Warning

Do not contact moving parts.

⚠ Warning

All covers and access panels must be in place and properly secured, before operating this equipment.

⚠ Warning

Do not use electrical appliances inside the food storage compartment of this appliance.

⚠ Warning

The operator of this equipment is solely responsible for ensuring safe holding temperature levels for all food items. Failure to do so could result in unsafe food products for customers.

⚠ Warning

Overloading shelves can damage equipment or cause bodily injury.

⚠ Warning

Damp or wet hands may stick to cold surfaces.

⚠ Warning

Do not block the supply and return air grills or the air space around the air grills. Keep plastic wrappings, paper, labels, etc. from being airborne and lodging in the grills. Failure to keep the air grills clear will result in unsatisfactory operation of the system.

⚠ Caution

Do not throw items into the storage area. Failure to heed this recommendation could result in damage to the interior of the cabinet or to the blower coil.

R290 Controls/Programming/Settings

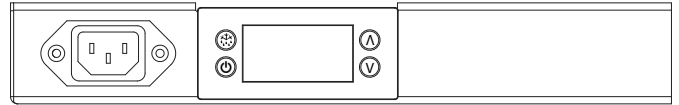

Standard Control Panel

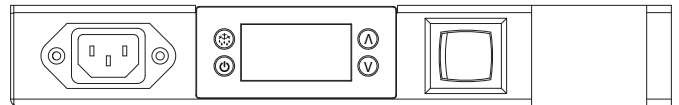

Freezer Control Panel With Optional Power Switch

R290 Refrigerator

Refrigerators are factory set at mid-range to maintain about 38°F (3°C) box temperature.

1. At initial start-up or anytime power is disconnected, then reconnected to the unit, the control will go into defrost mode.
2. The control will enter a DEFROST mode and the display will read dEF. The compressor and condenser fan as well as the evaporator fan will remain off until this initial defrost is complete. This initial defrost cycle may take up to 35 minutes to complete.
3. The display will continue to read dEF for an additional 30 minutes while the cooling cycle cools the box to the set temperature.
4. Then the digital thermostat will display box temperature.
5. The temperature control will cycle the compressor, evaporator fan motor and condenser fan motor to maintain box temperature at the control setting. For more information see R290 Evaporator Fan Operation on page 15.

R290 Refrigerator Defrost

The temperature control also monitors the evaporator temperature and will turn off the compressor and condenser fan motor when needed to allow accumulated frost on the evaporator to clear. During this defrost cycle, the digital temperature display will read dEF. After the defrost cycle is complete, the temperature control will return to a normal cooling cycle, but the display will continue to read dEF until the evaporator returns to normal cooling temperatures (up to 30 minutes).

R290 Freezer

Freezers are factory set at mid-range to maintain about -3°F (-19°C) box temperature.

1. At initial start-up or anytime power is disconnected, then reconnected to the unit, the control will go into defrost mode
2. The control will enter a DEFROST mode and the display will read dEF. The compressor and condenser fan as well as the evaporator fan will remain off until this initial defrost is complete. This initial defrost cycle may take up to 35 minutes to complete.
3. The display will continue to read dEF for an additional 30 minutes while the freezing cycle cools the box to the set temperature.
4. Then the thermostat will display box temperature.
5. The temperature control will cycle the compressor, evaporator fan motor and condenser fan motor to maintain box temperature at the control setting. For more information see R290 Evaporator Fan Operation on page 15.

R290 Freezer Automatic Defrost

The control also monitors compressor total running time and will enter a defrost cycle after total compressor running time is greater than seven hours since the last defrost cycle OR if evaporator coil temperature drops below -30°F (-34°C) (indicating excessive frost on the coil).

R290 Freezer Manual Defrost









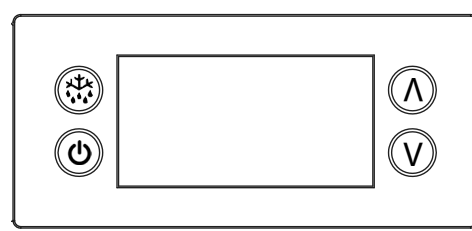

If a manual defrost is desired, hold the upper left button for five seconds or unplug the unit for several seconds, then plug unit back in. This will cause the control to re-initialize and then enter a defrost cycle.

When the control enters the defrost mode, it switches off the evaporator fan motor, compressor and condenser fan motor, and switches on the defrost heater to warm the evaporator coil. Thereby melting all frost accumulated during the previous refrigeration cycle. The digital temperature display will now read dEF. The control will continue the defrost cycle for a MINIMUM of six minutes and a MAXIMUM of 35 minutes depending on the amount of frost accumulated on the evaporator coil.

After the defrost cycle is complete, the control returns to a normal refrigeration cycle, however the evaporator fan motor will not switch on until the evaporator reaches -5°F (-21°C) or two minutes AFTER the compressor and condenser fan motor have begun operating. The digital temperature display will continue to read dEF until the evaporator has returned to normal freezing temperatures (up to 30 minutes).

R290 TEMPERATURE CONTROL & DISPLAY



Operation / Indication			
Status	Displayed		Comments
Normal (°C)	Temp. [°C]		Unit depends on setting (parameters in control)
Normal (°F)	Temp. [°F]		
Show set-point	Temp.		
Set to Defrost	dEF / Temp		Depends on setting (parameters in control or as chosen by upper left button)
Sensor 1 defect	E01 	X	Air sensor
Sensor 2 defect	E02 	X	Coil sensor
Sensor 3 defect	E03 	X	Open
Sensor 4 defect	E04 	X	Open
High temperature alarm	Hi 	X	Automatically switching at 2 sec rate
Low temperature alarm	Lo 	X	
Line voltage too high	uHi 	X	
Line voltage too low	uLi 	X	
Control calls for cooling for more than 24 hours straight	LEA 	X	Time includes defrost. Error will go away if the control cycles off the compressor or if the power is shut off. If error is on a cold pan it could be related to a high ambient temperature or not shutting the rail off nightly.

Press upper or lower right button.

- Display show actual set-point (blinking).
 - » If buttons untouched for 3 seconds returns to normal.
- Increase set-point by pressing upper button. Max value depends on parameters in control.
- Decrease set-point by pressing lower button. Min value depends on parameters in control.
 - » If buttons untouched for 3 seconds returns to normal and stores new set-point.

Press upper left button for 5 seconds.

- Start defrost.

Press lower left button for 5 seconds.

- Unit goes into stand-by mode.
 - » The display will read off, then a period.
- Press the lower left button again for 5 seconds.
 - » The display will read on.
 - » The unit will then start up in the defrost mode, and display will read dEF.

R290 Power Switch

Select units are equipped with a power disconnect switch located behind the louvered panel. Switch must be in the on position for the unit to operate. If the switch is turned off, then returned to the on position, the unit will enter a defrost cycle and the display will read dEF.

R290 Energy Saver Switch

Select freezers are equipped with an energy saver switch for service use. It is a rocker switch located behind the mechanical raceway. It controls the length of time that heat is applied to the door perimeter. The normal operating position for this switch is the on position, providing the shortest amount of time. If excessive condensation is observed on the door opening, switch to the off position with the help of an authorized service agent. The off position will increase the length of time the door heater is on.

R290 Temperature Alarm

The alarm will sound and flash “HI” or “LO” 90 minutes after the unit has reached its alarm temperature point or after any power interruption if the temperature is above or below the alarm set points. Refrigerators are factory set at mid-range to maintain about 38°F (3°C) box temperature. The high refrigerator temperature point is 50°F (10°C). The low refrigerator temperature point is 25°F (-4°C). Freezers are factory set at mid-range to maintain about -3°F (-19°C) box temperature. The high freezer temperature point is 20°F (-7°C). Freezers do not have a low temperature point.

R290 EVAPORATOR FAN OPERATION

During normal operation the evaporator fan may cycle and/or pulse independently of the compressor. Consult Technical Support at 1-844-724-CARE if you are unsure of the proper function.

	Cooling Cycle				Defrost Cycle	
	Compressor On		Compressor Off		Compressor Off	
	Evap Fan On	Evap Fan Off	Evap Fan On	Evap Fan Off	Evap Fan On	Evap Fan Off
Refrigerator	X		Cycles On 2-Min, Off 2-Min		X	
Freezer	X			X		X

CHANGING DISPLAY FROM FAHRENHEIT TO CELSIUS ON ERC112 CONTROL

1. Simultaneously hold the up and down arrows for 5 seconds to access menu for password protected parameters.



2. Screen should temporarily flash **PAS** and then move to a numeric screen.



3. Scroll to **187** using the up/down arrows and push the stand-by button (lower left button) to enter.



4. Scroll to **dis** using the up/down arrows and push the stand-by button (lower left button) to enter into the display menu.



5. Scroll to **CFu** using the up/down arrows and push the stand-by button (lower left button) to enter the display unit menu.



6. **-F** should be displayed indicating Fahrenheit. Use the down arrow to change it to **-C** for Celsius and hit the stand-by button (lower left button) to enter the change.



7. Push the defrost button (upper left button) to move out of the display unit menu.



8. Push the defrost button (upper left button) to move out of the display menu and back to the normal display.

NOTE: For steps 7 and 8, display will return back to normal display after 30 seconds of inactivity.



Section 4 Maintenance

⚠ DANGER

It is the responsibility of the equipment owner to perform a Personal Protective Equipment Hazard Assessment to ensure adequate protection during maintenance procedures.

⚠ DANGER

Failure to disconnect the power at the main power supply disconnect could result in serious injury or death. The power switch DOES NOT disconnect all incoming power.

⚠ DANGER

Disconnect electric power at the main power disconnect for all equipment being serviced. Observe correct polarity of incoming line voltage. Incorrect polarity can lead to erratic operation.

⚠ Warning

Never use sharp objects or tools to remove ice or frost. Do not use mechanical devices or other means to accelerate the defrosting process.

Cleaning and Sanitizing Procedures

⚠ Caution

Maintenance and servicing work other than cleaning as described in this manual must be done by an authorized service personnel.

GENERAL

⚠ Warning

When using cleaning fluids or chemicals, rubber gloves and eye protection (and/or face shield) must be worn.

Owners and operators are responsible for maintaining the equipment in accordance with the instructions in this manual. Maintenance procedures are not covered by the warranty.

Maintenance	Daily	Weekly	Monthly	After Prolonged Shutdown	At Start-Up
Interior	X			X	X
Gasket	X			X	X
Exterior	X			X	X
Drain		X		X	X
Condenser Coil			X	X	X
Casters			X	X	X

INTERIOR CLEANING**Notice**

When cleaning interior and exterior of unit, care should be taken to avoid the front power switch and the rear power cord. Keep water and/or cleaning solutions away from these parts.

Notice

Never use a high-pressure water jet for cleaning or hose down or flood interior or exterior of units with water. Do not use power cleaning equipment, steel wool, scrapers or wire brushes on stainless steel or painted surfaces.

The interior can be cleaned using soap and warm water. If this isn't sufficient, try ammonia and water or a nonabrasive liquid cleaner.

PREVENTING BLOWER COIL CORROSION

To help prevent corrosion of the blower coil, store all acidic items, such as pickles and tomatoes, in seal-able containers. Immediately wipe up all spills.

EXTERIOR CLEANING**Notice**

Never use an acid based cleaning solution on exterior panels! Many food products have an acidic content, which can deteriorate the finish. Be sure to clean the stainless steel surfaces of ALL food products.

Clean the area around the unit as often as necessary to maintain cleanliness and efficient operation.

Wipe gasket and surfaces with a damp cloth rinsed in water to remove dust and dirt from the outside of the unit. Always rub with the "grain" of the stainless steel to avoid marring the finish. If a greasy residue persists, use a damp cloth rinsed in a mild dish soap and water solution. Wipe dry with a clean, soft cloth.

Never use steel wool or abrasive pads for cleaning. Never use chlorinated, citrus based or abrasive cleaners.

Stainless steel exterior panels have a clear coating that is stain resistant and easy to clean. Products containing abrasives will damage the coating and scratch the panels. Daily cleaning may be followed by an application of stainless steel cleaner which will eliminate water spotting and fingerprints. Early signs of stainless steel breakdown are small pits and cracks. If this has begun, clean thoroughly and start to apply stainless steel cleaners in attempt to restore the steel.

DRAIN

Each unit has a drain located inside the unit that removes the condensation from the evaporator coil and routes it to an external condensate evaporator pan. Each drain can become loose or disconnected during normal use. If you notice water accumulation on the inside of the unit, be sure the drain tube is connected to the evaporator drain pan. If water is collecting underneath the unit, make sure the end of the drain tube is in the condensate evaporator. The leveling of the unit is important as the units are designed to drain properly when level. Be sure all drain lines are free of obstructions.

CLEANING THE CONDENSER COIL

In order to maintain proper refrigeration performance, the condenser fins must be cleaned of dust, dirt and grease regularly. It is recommended that this be done monthly. If conditions are such that the condenser is totally blocked in a month, the frequency of cleaning should be increased. Clean the condenser with a vacuum cleaner or stiff brush. If extremely dirty, a commercially available condenser cleaner may be required.

Failure to maintain a clean condenser coil can initially cause high temperatures and excessive run times. Continuous operation with a dirty or clogged condenser coil can result in compressor failure. Neglecting the condenser coil cleaning procedures will void any warranties associated with the compressor and cost to replace the compressor.

CASTERS

Wipe casters with a damp cloth monthly to prevent corrosion.

DOORS/HINGES

Over time and with heavy-use doors, the hinges may become loose. If this happens, tighten the screws that mount the hinge brackets to the frame of the unit. Loose or sagging doors can cause the hinges to pull out of the frame, which may damage both the doors and the hinges. In some cases this may require qualified service agents or maintenance personnel to perform repairs.

DRAWER REMOVAL FOR CLEANING

1. Pull drawer out until it hits a stop.



2. Pull white clip forward to release drawer from track.
3. Lift and remove drawer.

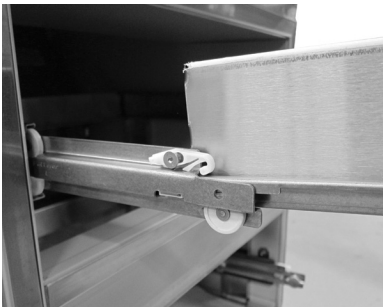

4. Pull intermediate tracks out until they hit a stop.
5. Locate gray safety clips on each drawer track. Push each gray safety clip until it clicks, releasing each intermediate track.



6. Remove intermediate tracks.

DRAWER CLEANING

Drawers and tracks should be cleaned on a weekly basis. The cleaner the tracks are the better they will operate.

- The drawer tracks are dishwasher safe or can be cleaned in a sink with detergents and a soft bristle brush. Using a soft bristle brush, wash the track making sure each roller is thoroughly cleaned.
- The drawer cage should be cleaned with a soft bristle brush, removing any food and debris gathered on the bottom ledge. Once it's cleaned thoroughly with a soft bristle brush, wipe remaining debris clean with a soft towel.

Drawer Reassembly

1. Push the intermediate tracks back into the drawer cage.
2. Press the gray plastic safety clip and finish installing the intermediate tracks.
3. Push the drawer back in slowly. It will hit a stop. Lift the front of the drawer up and continue inward.
4. Pull the drawer back out.
5. Locate the white clips on either side of the drawer. Press them down and in to lock.

DOOR HINGES

1. With a 3/8" nut driver remove the nuts and bottom hinge from the unit.



2. Remove door from unit.
3. Remove two screws from the bottom of the door to replace the hinge cartridge.



4. Place a white spacer on the bottom hinge pin.



5. Place the hinge on the hinge pin, rotate it and ensure there is tension in both directions.



6. Rotate the door hinge 160°-180°.

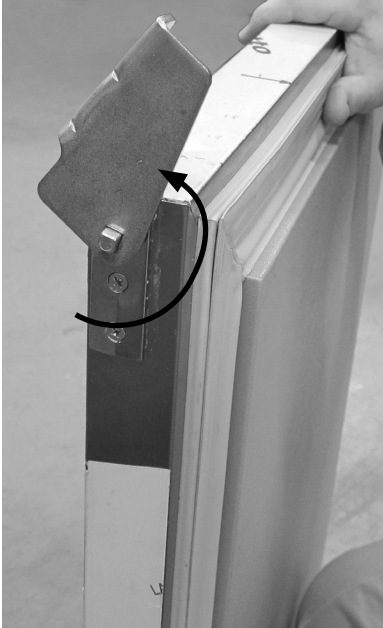

7. Hold the hinge, twist the door and slide the top pin into the top hinge.
8. Screw the bottom hinge to the unit.



9. Check the door alignment. Check that it shuts and seals. Adjust the bottom hinge if necessary.

Section 5 Troubleshooting

Problem -> Cause -> Correction Chart

Problem	Cause	Correction
Cabinet not running	Fuse blown or circuit breaker tripped.	Replace fuse or reset circuit breaker.
	Power cord unplugged.	Plug in power cord.
	Thermostat set too high.	Set thermostat to lower temperature.
	Main power switch turned off.	Turn main power switch on.
	Cabinet in defrost cycle. (Freezer models)	Wait for defrost cycle to finish.
Condensing unit runs for long periods or continuously	Excessive amount of warm product placed in cabinet.	Allow adequate time for product to cool down.
	Prolonged door openings or door(s) ajar.	Make sure door(s) are closed when not in use. Avoid prolonged door openings.
	Door gasket(s) not sealing properly.	Check gasket condition. Adjust door or replace gasket if necessary.
	Dirty condenser coil.	Clean the condenser coil.
	Evaporator coil iced over.	Turn unit off and allow coil to defrost. Make sure thermostat is not set too cold. Also, check gasket condition.
Cabinet temperature is too high	Thermostat set too high.	Set thermostat to lower temperature.
	Poor air circulation in cabinet.	Re-arrange product to allow proper air circulation.
	Exterior thermometer is out of calibration.	Re-calibrate thermometer.
	Excessive amount of warm product placed in cabinet.	Allow adequate time for product to cool down.
	Prolonged door openings or door(s) ajar.	Make sure door(s) are closed when not in use. Avoid prolonged door openings.
	Dirty condenser coil.	Clean the condenser coil.
	Evaporator coil iced over.	Turn unit off and allow coil to defrost. Make sure thermostat is not set too cold. Also, check gasket condition.
Cabinet is noisy	Loose part(s).	Locate and tighten loose part(s).
Refrigerator is freezing product	Thermostat is set too low.	Set thermostat to higher temperature.
	Dirty condenser coil.	Clean the condenser coil.
	Not enough cabinet clearance for proper refrigeration system operation.	Move cabinet or make other adjustments to gain proper cabinet clearances.
Compressor will not start	Low voltage to cabinet.	Check and correct incoming voltage to cabinet.
Temperature display reads E1	Box temperature sensor circuit is either open or shorted.	Check resistance of sensor for open or short and replace sensor if either condition is found. If not, replace control.
Temperature display reads E2	Coil temperature sensor circuit is either open or shorted.	Check resistance of sensor for open or short and replace sensor if either condition is found. If not, replace control.
Temperature display reads E6	Control has a defective potentiometer.	Replace control.
Temperature display reads E13	Communication error between controller and display.	Check for loose plugs on cable from control to display. If there are no loose plugs the display or control may need to be replaced.

**WWW.WELBILT.COM**

Welbilt provides the world's top chefs, and premier chain operators or growing independents with industry leading equipment and solutions. Our cutting-edge designs and lean manufacturing tactics are powered by deep knowledge, operator insights, and culinary expertise. All of our products are backed by KitchenCare® – our aftermarket, repair, and parts service.

- ▶ CLEVELAND
- ▶ CONVOTHERM®
- ▶ DELFIELD®
- ▶ FITKITCHEN™
- ▶ FRYMASTER®
- ▶ GARLAND
- ▶ KOLPAK®
- ▶ LINCOLN
- ▶ MANITOWOC®
- ▶ MERCO®
- ▶ MERRYCHEF®
- ▶ MULTIPLEX®