

# Operation Manual



## Product Holding Bin DHB-BK Series (with Prince Castle Button Bar)



### LIMITED WARRANTY

This product is warranted to be free from defects in material and/or workmanship for a period of 2 years from date of original installation, not to exceed 30 months from the date of manufacture.

Any component which proves to be faulty in material and/or workmanship will be replaced or repaired (at the option of Prince Castle, Inc.) without cost to the customer for parts and labor. This warranty covers on location service (i.e. trip charges and or mileage). Travel mileage is limited to 100 miles (200 Kilometers) round trip (one trip warranty) from an authorized service agency or its sub-service agency.

This warranty is subject to the following exceptions/conditions:

- Use of any non-genuine Prince Castle parts voids this warranty.
- All labor to be performed during regular work hours. Overtime premium (the incremental amount) will be charged to the customer.
- Damage caused by carelessness, neglect and/or abuse (e.g., dropping, tampering or altering parts, equipment damaged in shipment, by fire, flood or an act of God) is not covered under this warranty.
- All problems due to operation at voltages other than that specified on equipment nameplates are not covered by this warranty. Conversion to correct voltage is the customer's responsibility.
- This equipment must be serviced by Prince Castle Authorized Service Agency or a Prince Castle Service Technician during the warranty period.

**Note: When connected to the Kitchen Minder, the Transfer and Daypart functions are disabled on the button bar.**

### TABLE OF CONTENTS

Safety Information	2
Electrical Specifications	2
Product Identification	2
Installation	3
Operation	3
Cleaning	5
Setting the Temperature	5
Calibrating Heaters	6
Selecting Breakfast and Regular Menus	7
Programming the Menus	7
Changing the Hold and Cook-More Times	8
Changing Product Names	9
CastleNet® Communications Network	10
Factory Presets	11
Troubleshooting	12
Wiring Diagram	12
Exploded View and Parts List	13

**PRINCE CASTLE LLC**   
WORLDWIDE

355 East Kehoe Blvd. • Carol Stream, IL 60188 USA  
Telephone: 630-462-8800 • Toll Free: 1-800-PCASTLE  
Fax: 630-462-1460 • [www.princecastle.com](http://www.princecastle.com)

**Safety Information**

**⚠ WARNING**

Indicates information important to the proper operation of the unit. Failure to observe may result in damage to the equipment and/or severe bodily injury or death.

**⚠ CAUTION**

Indicates information important to the operation of the unit. Failure to observe may result in damage to the equipment.

**Electrical Specifications**

Model No.	Volts	Watts	Amps	Hz
DHB-BK1C	208 – 240	2500	8.7 – 10.5	50/60 UL
DHB-BK3C	208 – 240	2500	8.7 – 10.5	50/60 UL
DHB-BK5C	220 – 240	2300	10.0	50/60 CE
DHB-BK7C	220 – 240	2300	10.0	50/60 CE

**Product Identification**

**Components**

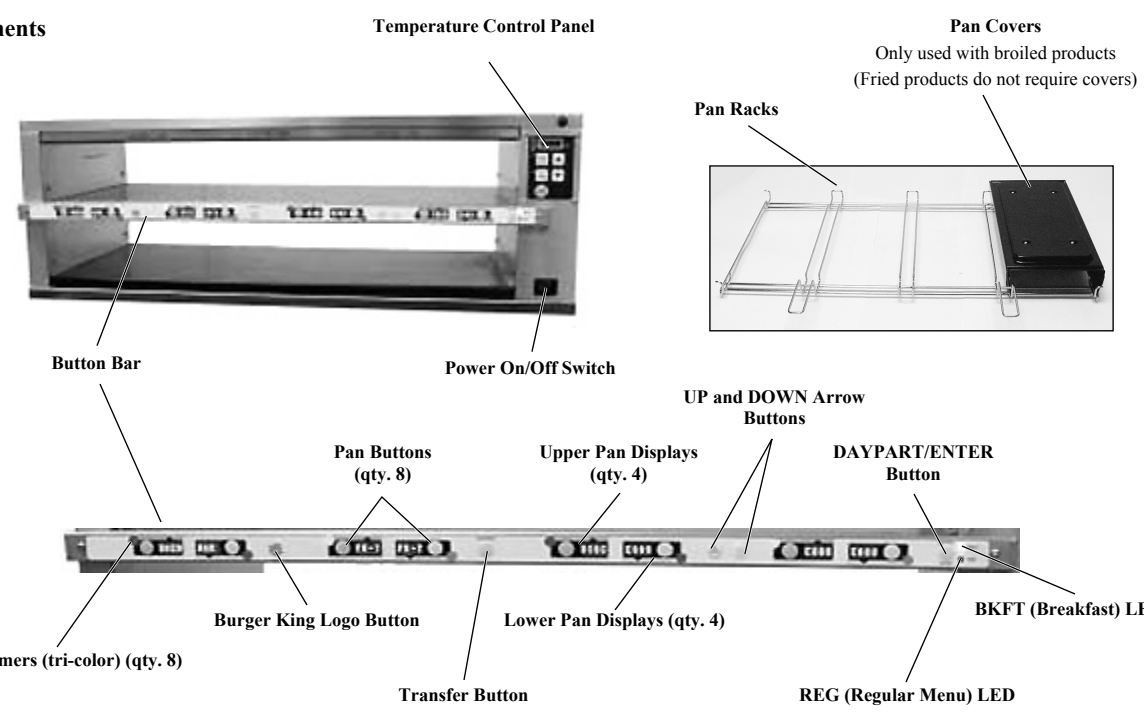

**Temperature Control Panel**

**Pan Covers**  
Only used with broiled products  
(Fried products do not require covers)

**Pan Racks**

**Button Bar**

**Power On/Off Switch**

**LED Timers (tri-color) (qty. 8)**

**Burger King Logo Button**

**Pan Buttons (qty. 8)**

**Transfer Button**

**Upper Pan Displays (qty. 4)**

**Lower Pan Displays (qty. 4)**

**UP and DOWN Arrow Buttons**

**DAYPART/ENTER Button**

**BKFT (Breakfast) LED**

**REG (Regular Menu) LED**

**Important**

Prince Castle reserves the right to change specifications and product design without notice. Such revisions do not entitle the buyer to corresponding changes, improvements, additions or replacements for previously purchased equipment.

## Installation

Remove the unit from the carton and inspect for signs of damage. If there is damage to the unit:

- notify the carrier within 24 hours of delivery
- save carton and packaging materials for inspection purposes
- contact your local dealer, or if purchased directly, the Prince Castle Sales Department at 800-722-7853 or 1-630-462-8800 to arrange for a replacement unit.

Verify that the following parts have been received.

- 1 pan cover kit

*NOTE: When installing this unit, the ambient temperature at the mounting site should not exceed 100°F.*

Plug the power cord into the proper electrical receptacle. All electrical connections must be in accordance with local electrical codes and any other applicable codes.

If the unit is to be networked with other Prince Castle units, refer to the CastleNet® Communication Network section in this manual for installation instructions.

## Operation

- 1** Turn power On/Off switch (A) to ON position.

Load pan covers (if used) onto pan racks and insert racks into the unit.

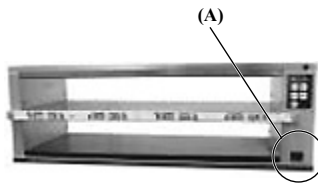

Allow 20 minutes for heaters to reach operating temperature. The Temperature Display will read "--" until unit is warmed up, then display will show pre-programmed operating temperature.

- 2** Press all PAN buttons.  
The PAN displays will show the assigned product name.

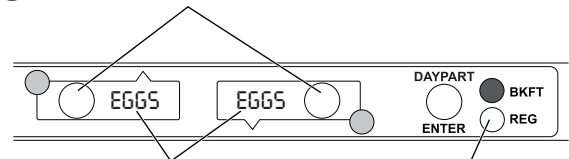

If no product is assigned, the display will be dim and show "----". Pressing the PAN button will not activate the timer if "----" is displayed. Pressing PAN button when product name is displayed will start timing cycle.

BKFT (Breakfast) or REG (Regular Menu) will be lit depending on pre-programmed menu.

- 3** LED Timing Status



LED Timers

- RED (steady) = Ready for product
- RED (flashing) = Discard product
- GREEN (steady) = Oldest product, use first
- GREEN (flashing) = Cook more product
- YELLOW (steady) = Newer product, use green first
- YELLOW (flashing) = Cook more product

- 4** When LED is steady RED, load product and press the PAN button.

If more than one pan is active for a product, the LED for the first pan loaded will turn from RED to GREEN.

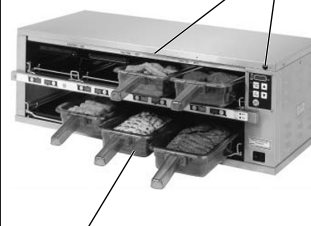

The LED for the 2nd pan loaded will turn from RED to YELLOW.

An LED timer can be stopped (cancelled) at any time by pressing and releasing the corresponding PAN button.

If only one pan is active for a product, the LED will turn from RED to GREEN.

**Operation (continued)**

**5** When any of the timer LEDs flash, cook more product or remove and discard product as indicated.



- GREEN** (flashing) = Cook more product
- YELLOW** (flashing) = Cook more product
- RED** (flashing) = Discard product

**WARNING**  
Hot surfaces.

**6** Product, along with any remaining time, can be transferred from one cavity to another as follows:

- A. Press and release the TRANSFER button. All displays will flash between bright and dim.
- C. Press and release the TRANSFER button again.



- B. Press and release the PAN button of the product to be moved. All displays except this one will stop flashing.
- D. Move the product. Press and release the PAN button for the new location. The new location will finish timing the product. When the transferred pan timing expires, location will revert to original menu setting.

*NOTE: If product transfer is not completed within a pre-programmed transfer time, the transfer will be cancelled. See your Manager.*

**7** To change a menu selection for a specific pan cavity, use the following steps:

- A. Press and hold the BURGER KING LOGO button for 6 seconds. All PAN displays will show PROG. All LED Timers will be RED.
- D. Press the UP or DOWN Arrow button to scroll to the desired menu item.
- E. Press the DAYPART/ENTER button to select the menu item.

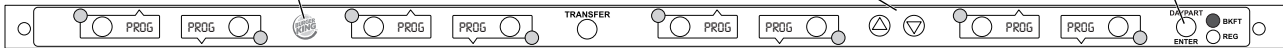

- B. Press and hold the DAYPART/ENTER button. The display next to the DAYPART/ENTER button will display the menu choices. While holding the DAYPART/ENTER button, press the UP or DOWN Arrow button to scroll through the menu choices.
- F. Repeat steps A – E as required for other PAN displays. Press the BURGER KING LOGO button to exit the Program Mode.

- C. Press a PAN button to change the menu. The LED Timer will change to YELLOW and the display will change from PROG to the assigned menu item.

*NOTE: Up to six menu items may be programmed for each PAN display. In addition, a pan may be set as "not used" by assigning "----" as its product.*

**Operation (continued)**

**8** To shut down the unit, turn the power On/Off switch (A) to OFF.

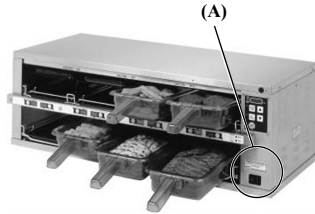

**Cleaning**

**! WARNING**

Before performing any maintenance, turn the power switch to the OFF position and unplug the power cord from the electrical receptacle.

**! CAUTION**

This unit is not watertight. Do not clean with a water jet/jet spray. Do not immerse the unit in water.

1. Turn the unit off and unplug the power cord from the electrical receptacle.
2. Remove the pan covers and pan racks. Wipe all parts and unit with a damp cloth. DO NOT use a green Scotch Bright pad cleaner, ice or water.

**Setting the Temperature**

**1** The unit has two shelves, each with an upper and lower heater (four heaters total).  
The factory pre-set for the two upper heaters is 225°F.  
The factory pre-set for the two lower heaters is 195°F.  
Each heater has a programmable range of 150° – 275°F.  
Use the control below and the following steps to set the setpoint temperatures for each heater.

**UPPER SHELF LED**  
This LED will be lit to indicate upper shelf is selected.

**PROG LED**  
This LED will be lit to indicate unit is in Program Mode.

**LOWER SHELF LED**  
This LED will be lit to indicate lower shelf is selected.

**ACTUAL TEMP BUTTON and LED**  
Press to display actual temperature for the selected heater. LED will be lit when actual temperature is displayed.

**SETPOINT BUTTON and LED**  
Press to display setpoint temperature of a selected heater. LED will be lit when setpoint temperature is displayed.

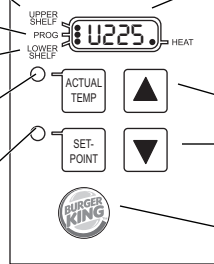

**TEMPERATURE DISPLAY**

U = Upper Heater  
L = Lower Heater

*NOTE: The unit is preset to display temperature in Fahrenheit. To display in Celsius, press and hold the DOWN Arrow button immediately after turning on the power switch. To switch back to Fahrenheit, press and hold the UP Arrow button after turning on the power switch.*

**UP/DOWN ARROW BUTTONS**  
Used with other Buttons to scroll through heater and temperature selections.

**BURGER KING LOGO BUTTON**  
Press to enter temperature selections.

**CAUTION**  
DISPLAYED TEMPERATURES ARE HEATER TEMPERATURES AND DO NOT INDICATE ACTUAL FOOD TEMPERATURES.

*NOTE: To reset all times and temperatures to the factory settings, turn the unit off, then press and hold the UP and DOWN Arrow buttons simultaneously while turning the unit back on. A "P" will appear in the display and all times and temperatures will be reset to original factory settings.*

### Setting the Temperature (continued)

- 2** Press the UP or DOWN Arrow button until the desired shelf LED and upper (U) or lower (L) heater is selected.

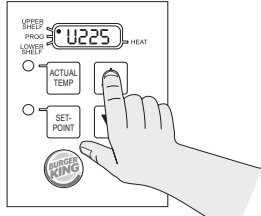

- 3** Press and hold the SETPOINT button and the BURGER KING LOGO button for 5 seconds. The Program LED will light.

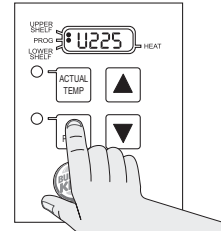

- 4** Press the UP or DOWN Arrow button until the desired setpoint temperature is displayed.

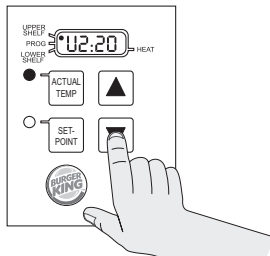

- 5** Press the BURGER KING LOGO button to save the new setpoint value. Repeat Steps 2 – 5 to change the setpoint for any other heater.

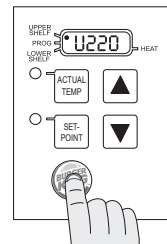

### Calibrating Heaters

- 1** Use the following steps to calibrate the individual heaters.

*NOTE: Allow sufficient amount of time for temperatures to stabilize before starting calibration.*

Press the UP or DOWN Arrow button until the desired shelf LED and upper (U) or lower (L) heater is selected.

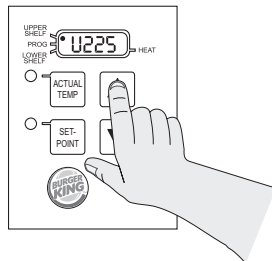

- 2** Take a temperature reading within the shelf near the center of the heater surface.

Use a stand-alone temperature meter (not supplied).



**WARNING**

Hot surfaces. Use caution when taking temperature readings within the shelf.



- 3** A. Press and hold the BURGER KING LOGO and ACTUAL TEMP buttons for 5 seconds. The colon (:) LED indicator will light. The temperature displayed is the actual heater temperature sensed by the controller.  
B. To clear any offset readings, press the SETPOINT button.

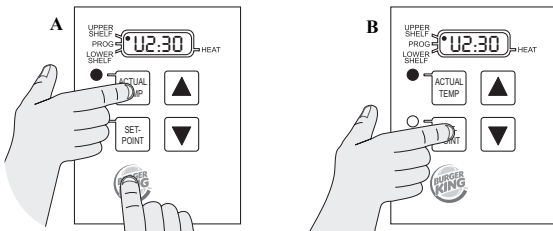

- 4** A. Press the UP or DOWN Arrow button until the temperature displayed matches the reading obtained in Step 2.  
B. Press the BURGER KING LOGO button to save the temperature value and exit the Calibration Mode.

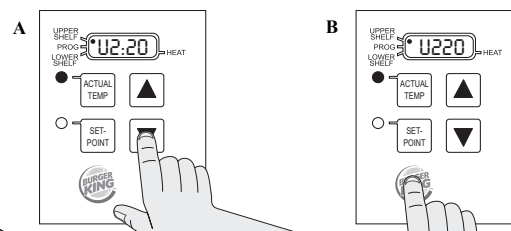

## Selecting Breakfast and Regular Menus

- There are six menus available:  
BKFT LED ON = Breakfast1 or Breakfast2  
REG LED ON = Regular1, Regular2, Regular3, or Regular4  
Press and hold the DAYPART/ENTER button, then use the UP or DOWN Arrow button to scroll through the 6 menus.

When scrolling, menus appear in this display.



- When the desired menu is displayed, release the DAYPART/ENTER button. The food products for the menu will be displayed in the upper and lower PAN displays.

When you change to a new menu, any timers started before the change will flash the product name from the previous menu. Press the PAN button next to the flashing display to cancel the timer and stop the display from flashing.



## Programming the Menus

- Press and hold the BURGER KING LOGO button (on the button bar) until all the displays show PROG and the PAN buttons LEDs all glow RED.

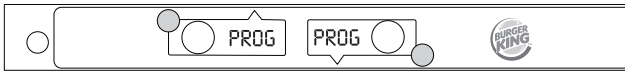

- Press and hold the DAYPART/ENTER button, then use the UP or DOWN Arrow button to scroll through the 6 menus. Release the DAYPART/ENTER button when the desired menu is displayed.



When the DAYPART/ENTER button is released, all displays will again show PROG.



- Press the PAN button next to the display to be changed. The LED will change from RED to YELLOW and the display will change from PROG to the assigned menu item.



Press the UP or DOWN Arrow button to scroll to the desired product. Press the DAYPART/ENTER button to save the selection. All other displays will show PROG.

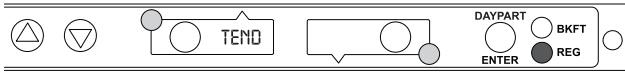

- Repeat Steps 2 – 3 as required. Press the BURGER KING LOGO button to exit the Program Mode.  
*NOTE: A pan may be set as "not used" by assigning "--" as its product.*



**Changing the Hold and Cook-More Times**

- 1 The SET PRODUCT TIME menu is used to change the Hold and Cook-More times.  
Press and hold the BURGER KING LOGO button, then immediately press and hold the DAYPART/ENTER button until the display shows one of four programming menus.  
Use the UP or DOWN Arrow button to scroll to the SET PROD TIME ↑ ↓ ENTR (Set Product Time) menu.

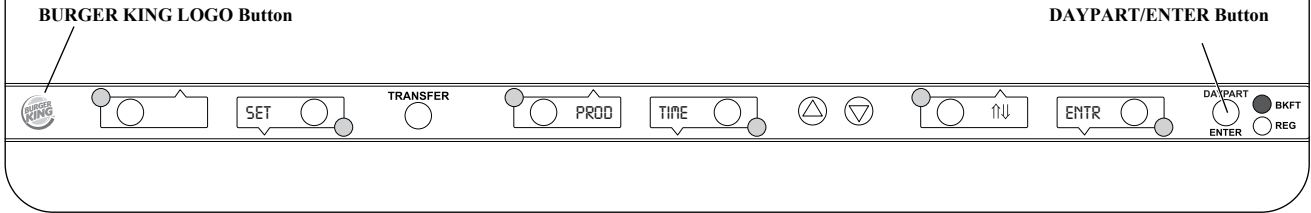

- 2 Press and release the DAYPART/ENTER button to enter the Set Product Time menu. The display will show SET EGGS TIME ↑ ↓ ENTR.  
Use the UP or DOWN Arrow button to scroll through the list of products. When the desired product is displayed, press the DAYPART/ENTER button to select it.



*NOTE: Holding the UP or DOWN Arrow button for longer than 2 seconds will cause the product list to automatically scroll up or down.*

- 3 The display will show hold EGGS 2:00 ↑ ↓ ENTR.



Use the UP or DOWN Arrow button to scroll to the desired Hold time. When the desired Hold time is displayed, press the DAYPART/ENTER button to save the desired Hold time.

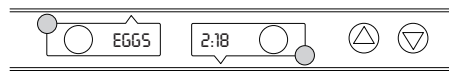

*NOTE: Hold time cannot be reduced to less than the Cook-More time plus one minute.*

- 4 The display will show cook EGGS :07 ↑ ↓ ENTR.

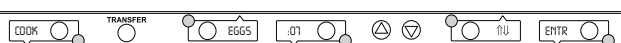

Use the UP or DOWN Arrow button to scroll to the desired Cook-More time. When the desired Cook-More time is displayed, press the DAYPART/ENTER button to save it.

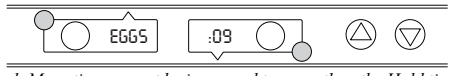

*NOTE: Cook-More time cannot be increased to more than the Hold time plus one minute.*

- 5 The display will show SET PROD TIME ↑ ↓ ENTR. Repeat Steps 2 – 4 for any other product.  
Press and release the BURGER KING LOGO button at any time to exit the Program Mode and return to the Run Mode.

*NOTE: If the DAYPART/ENTER button has not been pressed to save any changes, the program will revert to the original values.*



## Changing Product Names

- The EDIT PRODUCT NAME menu is used to change a default product name to one of your own choosing.

Press and hold the BURGER KING LOGO button, then immediately press and hold the DAYPART/ENTER button until the display shows one of four programming menus.

Use the UP or DOWN Arrow button to scroll to the SEL PROD xxxx ↑↓ ENTR (Edit Product Name) menu.

*NOTE: The default names available for editing are BACN, POP, MOZ, SPCY and EXP1 through EXP9.*

BURGER KING LOGO Button

DAYPART/ENTER Button

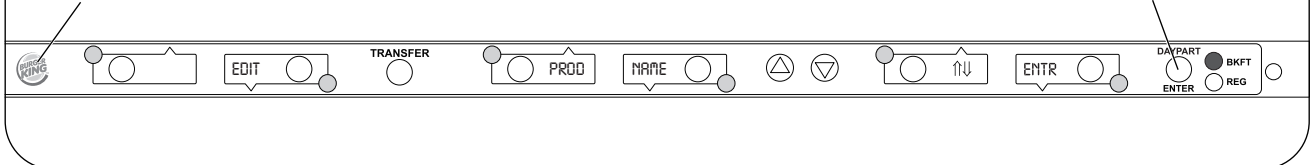

- Press and release the DAYPART/ENTER button to enter the Edit Product Name menu.

Use the UP or DOWN Arrow button to scroll through the list of products. When the desired product is displayed, press the DAYPART/ENTER button to select it.

The first letter (in this case, the E) will start blinking.

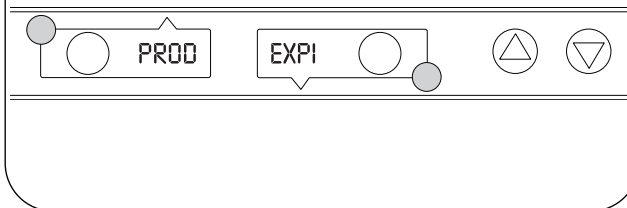

- To change the blinking E, use the UP or DOWN Arrow button to scroll to the desired letter/number/symbol. When the desired selection is displayed, press the PAN button to move to the next digit. Repeat for all digits.

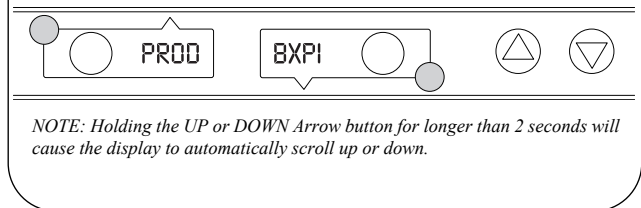

*NOTE: Holding the UP or DOWN Arrow button for longer than 2 seconds will cause the display to automatically scroll up or down.*

- When all four digits have been changed, press the DAYPART/ENTER button to select the new name.

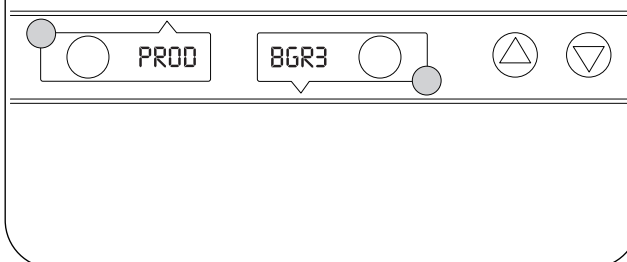

- The display will show edit prod name ↑↓entr. Repeat Steps 2 – 4 for any other product.

Press and release the BURGER KING LOGO button at any time to exit the Program Mode and return to the Run Mode.

*NOTE: If the DAYPART/ENTER button has not been pressed to save any changes, the program will revert to the original names.*

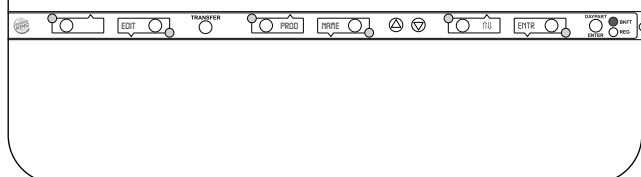

**CastleNet® Communications Network**

The Prince Castle DHB-BK1PC, DHB-BK3PC Bins, Retro Bun Timer and New Bun Cabinet Timers can be inter-connected to form the CastleNet® Communication Network. The network can be used for data transfer between bins and timers for menu updates or to transfer product Hold time from bin-to-bin.

Each bin is supplied with a standard 25' cable and allows units to be “daisy-chained” together to form the network. Extender cables are available (refer to Parts List on page 13).

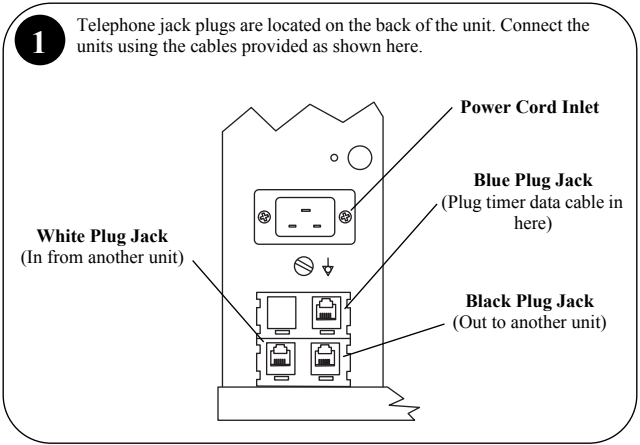

**2** The factory default address for all bins and timers is address 2. The factory default address for the Retro Bun Timer is BUNF.

To check the bin address, press and hold the ACTUAL TEMP and SETPOINT buttons. The display will show the bin address. Default for a new address is BIN2.

*EXAMPLE: If a location has three bins, the bins and timers must be set to address 1 through 3. See the following steps.*

**3** To change a bin address, disconnect power to the unit and wait 30 seconds. Reconnect power to the unit and immediately press and hold the ACTUAL TEMP and SETPOINT buttons.

Continue to hold the buttons until PROG LED turns on.

**4** Use the UP or DOWN Arrow button to scroll to the desired address. Press the BURGER KING LOGO button to store the new address.

Available addresses are:  
bin1 thru bin9, binA, binB, binC, binD, BINe and BinF.

*IMPORTANT: A timer address must match the corresponding bin address. For example, if the bin address is BIN3, the timer address must also be BIN3. Continue to Step 5 to check the timer address. Two timers mounted on separate bins cannot have the same address.*

**5** To check the timer address, press and hold the BURGER KING LOGO button and the DOWN Arrow button. The current timer address will be displayed in the far right timer display.

To change the timer address, proceed to Step 6.

**6** To change the timer address, disconnect power to the unit and wait 30 seconds. Reconnect power to the unit and immediately press and hold the BURGER KING LOGO button and the DOWN Arrow button until the display shows set addr ↑ ↓ enr bin2.

The address number will blink on/off.

**7** Use the UP or DOWN Arrow button to scroll to the desired address. Press the DAYPART/ENTER button to store the new address and return to normal operating mode.

*Available addresses are:*  
BIN1 thru BIN9 and BINA, BINB, BINC, BIND, BINE, and BINF.

**Factory Presets**

**Product Menu Details**

Product	Display Name	Hold Minutes <sup>1</sup>	Cook-More Minutes <sup>1</sup>
Eggs	EGGS	120	7
Biscuits	BISC	60	17
Sausage	SAUS	60	1
French Toast	FR-T	30	2
Ham	HAM	120	2
Fish	FISH	45	5
Chicken Crisp	CRSP	45	3
Chick Patty	CHKN	45	3
Chicken Tenders	TEND	30	3
Burgers	BURG	60	3
Whoppers	WHPR	45	3
BK Broiler	-BK-	60	6
Bacon	BACN <sub>2</sub>	120	2
Poppers	POP <sub>2</sub>	30	2
Mozzarella Stick	MOZ <sub>2</sub>	30	2
Spicy Chicken Wings	SPCY <sub>2</sub>	60	3
Experimental #1	EXP1 <sub>2</sub>	60	2
Experimental #2	EXP2 <sub>2</sub>	60	2
Experimental #3	EXP3 <sub>2</sub>	60	2
Experimental #4	EXP4 <sub>2</sub>	60	2
Experimental #5	EXP5 <sub>2</sub>	60	2
Experimental #6	EXP6 <sub>2</sub>	60	2
Experimental #7	EXP7 <sub>2</sub>	60	2
Experimental #8	EXP8 <sub>2</sub>	60	2
Experimental #9	EXP9 <sub>2</sub>	60	2

1. Hold and Cook-More times may be re-programmed. See page 8.
2. Product abbreviations BACN through EXP9 may be reprogrammed. See page 9.

**Menus**

Timer 8	Timer 7	Timer 6	Timer 5	Timer 4	Timer 3	Timer 2	Timer 1	Menu	Indicator
BACN	HAM	FR-T	SAUS	BISC	EGGS	EGGS	EGGS	MNU1	Bkft
WHPR	WHPR	WHPR	WHPR	BURG	BURG	BURG	BURG	MNU2	Reg
TEND	TEND	CHKN	CHKN	CRSP	CRSP	FISH	FISH	MNU3	Reg
WHPR	WHPR	WHPR	WHPR	BURG	BURG	BURG	BURG	MNU4	Reg
SPCY	SPCY	MOZ	MOZ	POP	POP	-BK-	-BK-	MNU5	Reg
BACN	HAM	FR-T	SAUS	BISC	EGGS	EGGS	EGGS	MNU6	Bkft

**Troubleshooting**

PROBLEM	PROBABLE CAUSE	SOLUTION
Display flashes OpN and REL.	Open relay. Circuit inoperable.	Replace power circuit board.
Display flashes SHR and REL.	Shorted relay. Circuit inoperable. Open heater.  Unplugged ribbon cable between power and main circuit boards.	Replace power circuit board. Test heater resistance (150.2 Ohms). Replace heater if necessary. Verify ribbon cable connection.
Display flashes OPN and REL.	Temperature is below 75°F. Heater inoperable. Probe inoperable.  Relay inoperable.	Normal display during warmup. Test heater resistance (150.2 Ohms). Check for open thermocouple wires from probe. Replace heater/probe assembly. Replace power circuit board.
Display shows HHH for an extended period of time and heater surface temperature is hot.	Temperature is above 300°F (abnormal operation).	Diagnostic circuit inoperable. Replace power circuit board.
Display shows HHH for an extended period of time and heater surface temperature is cool.	Probe is inoperable.	Check for pinched thermocouple wires from probe. Replace heater/probe assembly.

**Wiring Diagram**

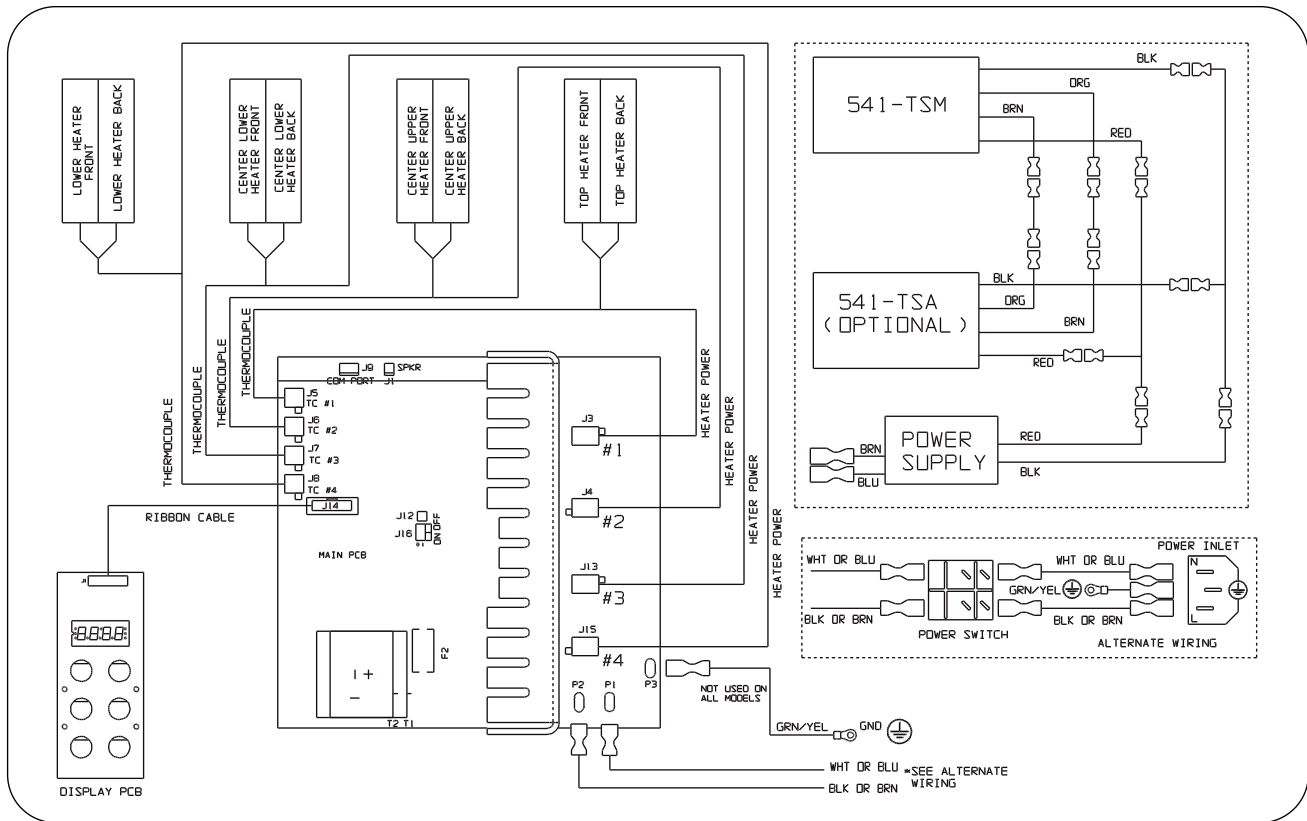

Exploded View and Parts List

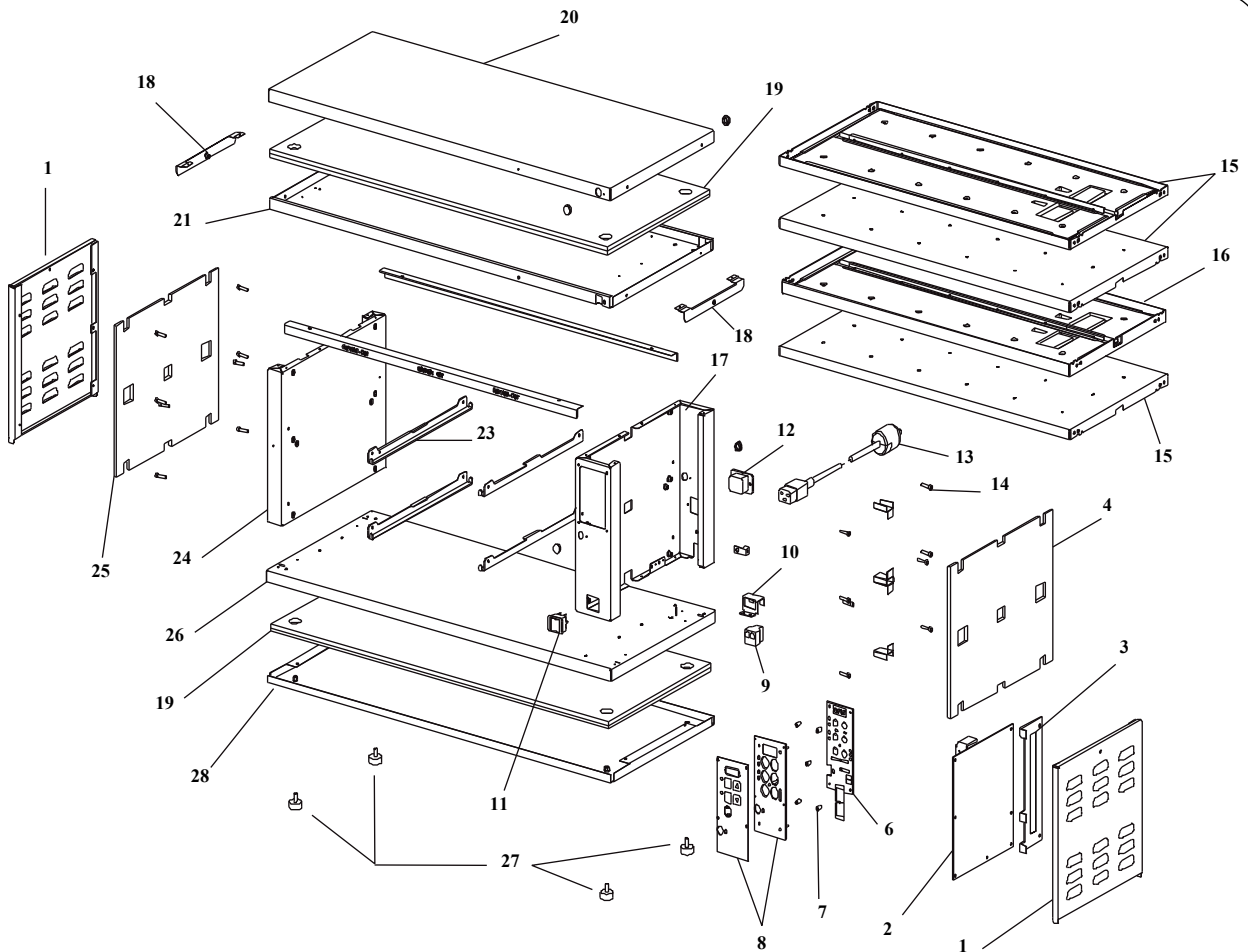

Ref.	Part No.	Description	Ref.	Part No.	Description
1	541-316	Side Panel Cover	20	541-329	Top Cover
2	541-735S	Main P.C. Board Kit	21	541-324	Header
3	541-799	P.C. Board Bracket	22	541-650	Trim
4	541-317	Insulation	23	541-383	Shelf Bracket
5	541-326	Wire Chase	24	541-488	Chassis, Left
6	541-333S	Display P.C. Board Kit	25	541-317	Insulation
7	89-955	Spacer	26	541-606	Base
8	536-802S	Overlay Kit	27	197-232	Foot
9	86-118	Hole Plug	28	541-322	Bottom Cover
10	541-320	Hold Down Bracket	*	541-723E4S	Black Pan Covers (Pkg of 4)
11	78-219S	Power Switch	*	940-0504	Cable, Radio Shack
12	88-609S	Power Inlet	*	PC-Comext	Tel Cable RJ12/RJ
13	72-200-25S	Power Cord Kit	*	541-636	Rack, Guide w/Hand
	72-235S	Power Cord Kit, UKC series	*	541-TSMCS	Button Bars (Main)
14	76-724	Screw, Socket, 8-32 x 3/4	*	541-TSACS	Button Bars (Aux)
15	541-375S	Lower Heater Assy (230 Volt)	*	541-TSMUKCS	Button Bars (Main for UKC Series)
16	541-376S	Upper Heater Assy (230 Volt)	*	541-TSAUKCS	Button Bars (Aux for UKC Series)
17	541-656	Chassis, Right	*	541-757S	Overlay (Main)
18	541-129	Side Cover Bracket	*	541-758S	Overlay (Aux)
19	541-369	Insulation Bottom			

\* Part not shown.

---

**PRINCE CASTLE LLC**   
WORLDWIDE

355 East Kehoe Blvd. • Carol Stream, IL 60188 USA

Telephone: 630-462-8800 • Fax: 630-462-1460

Toll Free: 1-800-PCASTLE

[www.princecastle.com](http://www.princecastle.com)