

# Operation Manual

Product Holding Bin  
DHB2PT-YUM Series

## Product Identification

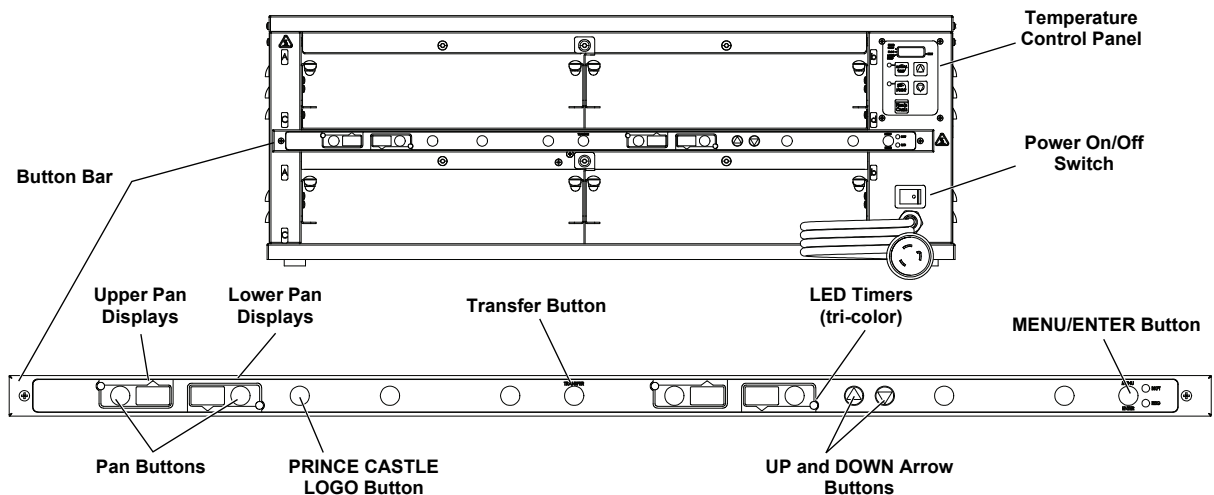

**NOTE:** No timer bars on models DHB2PT-33KFCCEN and DHB2PT-46KFCCEN. Four (4) high temperature amber pans 12" x 20" x 2-1/2" and covers not included.

### LIMITED WARRANTY

This product is warranted to be free from defects in material and/or workmanship for a period of 1 year from date of original installation, not to exceed 18 months from the date of manufacture.

Any component which proves to be faulty in material and/or workmanship will be replaced or repaired (at the option of Prince Castle, Inc.) without cost to the customer for parts and labor. This warranty covers on-location service (i.e. trip charges and/or mileage). Travel mileage is limited to 100 miles (200 Kilometers) round trip (one trip warranty) from an authorized service agency or its sub-service agency.

This warranty is subject to the following exceptions/conditions:

- Use of any non-genuine Prince Castle parts voids this warranty.
- All labor to be performed during regular work hours. Overtime premium (the incremental amount) will be charged to the customer.
- Damage caused by carelessness, neglect and/or abuse (e.g., dropping, tampering, or altering parts, equipment damaged in shipment, by fire, flood or an act of God) is not covered under this warranty.
- All problems due to operation at voltages other than that specified on equipment nameplates are not covered by this warranty. Conversion to correct voltage is the customer's responsibility.
- Normal adjustments as outlined in this manual are not covered under warranty.
- This equipment must be serviced by Prince Castle Authorized Service Agency or a Prince Castle Service Technician during the warranty period.

### TABLE OF CONTENTS

Product Identification	1
Safety Information	2
Electrical Information	2
Installation	2
Initial Startup	4
Resetting to Factory Defaults	4
Operation	4
Time Declination Feature	5
Cleaning	6
Setting Temperature	6
Programming for C & D Heaters for Percentage of Power	7
Control Panel	9
Programming	9
Calibrating Heaters	10
Selecting Regular Menu	10
Programming the Menu	11
Changing the Hold and Cook-More Times	12
Setting the Alternating Display Interval	12
Changing Product Names	13
Addendum: Audio	13
Set Maximum Transfer Time	14
Set Volume Level	14
CastleNet® Communications Network	15
Exploded View	16
Wiring Diagrams	17



**PRINCE CASTLE INC.**  
WORLDWIDE

355 East Kehoe Blvd. • Carol Stream, IL 60188 USA  
Telephone: 630-462-8800 • Toll Free: 1-800-PCASTLE  
Fax: 630-462-1460 • www.princecastle.com

## Safety Information

**⚠ WARNING**

Indicates information important to the proper operation of the unit. Failure to observe may result in damage to the equipment and/or severe bodily injury or death.

**⚠ CAUTION**

Indicates information important to the operation of the unit. Failure to observe may result in damage to the equipment.

## Electrical Information

Model	Volts	Hz	Watts	Amps	Plug	Agency
DHB2PT-33WS	208	60	3200	15.4	L6-20P	UL / cUL / UL Sanitation
DHB2PT-33KFC	208	60	3200	15.4	L6-20P	UL / cUL / UL Sanitation
DHB2PT-46KFC	208	60	4800	23.1	L6-30P	UL / cUL / UL Sanitation
DHB2PT-33KFCCE	220-240	50/60	4300 Max.	17.8 Max.	IEC309	CE / UL Sanitation
DHB2PT-46KFCCE	220-240	50/60	6400 Max.	26.7 Max.	IEC309	CE / UL Sanitation
DHB2PT-33KFCCEL	220-240	50/60	4300 Max.	17.8 Max.		CE / UL Sanitation
DHB2PT-46KFCCEL	220-240	50/60	6400 Max.	26.7 Max.		CE / UL Sanitation
DHB2PT-33KFCEN	220-240	50	4300	17.8		
DHB2PT-33KFCCT1	208	60	3200	15.4		
DHB2PT-33KFCCT2	208	60	3200	15.4		
DHB2PT-46KFCEN	220-240	50	6400	26.7		
DHB2PT-46KFCF12	208	60	4800	23.1	L6-30P	
DHB2PT-46KFCED	220-240	50/60	6400 Max.	26.7 Max.	IEC309	CE / UL Sanitation
DHB2PT-33KFCED	220-240	50/60	4300 Max.	17.8 Max.	IEC309	CE / UL Sanitation
DHB2PT-46KFCCEA	220/240	50/60	4300 Max.	17.8 Max.	IEC309	CE / UL Sanitation

## Installation

- A. Remove the unit from the carton and inspect for signs of damage. If there is damage to the unit:
- notify the carrier within 24 hours of delivery
  - save carton and packaging materials for inspection purposes
  - contact your local dealer, or if purchased directly, the Prince Castle Sales Department at 800-722-7853 or 1-630-462-8800 to arrange for a replacement unit.

*NOTE: When installing this unit, the ambient temperature at the mounting site should not exceed 100°F (37.8°C).*

- B. Place the bin on a counter and seal the base to the counter with food-approved sealant.
- C. Plug the power cord into the bin and connect the plug into the proper electrical outlet. All connections must be in accordance with local electrical codes and any other applicable codes.

*NOTE: The electrical receptacle should be a dedicated outlet. No other equipment should be operating on the line (refrigerators, fryers, etc.).*

- D. Turn the power switch to ON. Allow 30 minutes for warm-up.

*NOTE: If the unit is to network with other Prince Castle units, a Retro Bun Timer may be connected to any one bin in the chain. Refer to CASTLENET COMMUNICATIONS NETWORK in this manual.*

Prince Castle reserves the right to change specifications and product design without notice. Such revisions do not entitle the buyer to corresponding changes, improvements, additions or replacements for previously purchased equipment.

## Initial Startup

*NOTE: During the first few hours of operation, you may notice a faint odor. This is normal, and the odor disappears after the first few hours of use.*

The bin is tested and calibrated at the factory before shipment. However, due to temperature and climate changes during shipment, the insulation in

bin can absorb moisture. The odor during the first few hours of use is from the drying out of the insulation (moisture is driven from the insulation's binders, a starch-like material).

## Resetting to Factory Defaults

To revert all settings back to the original factory defaults (product times on button bars):

1. Turn the unit off.
2. Press and hold both UP and DOWN arrows.
3. Turn the unit back on and wait 5 seconds.
4. Release UP and DOWN arrows.

*NOTE: All previously saved settings are lost upon resetting the defaults! Use with caution.*

## Operation

- 1** Turn power On/Off switch to ON position.

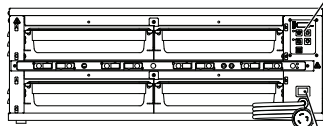

Power On/Off Switch

Allow **30 minutes** for heaters to reach operating temperature. The Temperature Display will show temperature as unit warms up to the operating temperature.

- 2** Press PAN Buttons.



The PAN DISPLAYS will show the assigned product name.

If no product is assigned, the display will be blank. Pressing the PAN button will not activate the timer if the display is blank. Pressing PAN button when product name is displayed will start timing cycle.

- 3** LED Timing Status



LED Timers

**RED** (steady) = Ready for product  
**RED** (flashing) = Discard product  
**GREEN** (steady) = Oldest product, use first  
**GREEN** (flashing) = Cook more product  
**YELLOW** (steady) = Newer product, use green first  
**YELLOW** (flashing) = Cook more product

- 4** When LED is steady RED, load product and press the PAN button.

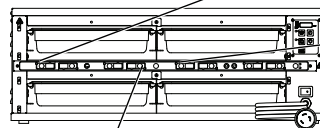

If only one pan is active for a product, the LED will turn from RED to GREEN.

If no other pan is active for a product, the LED for the first pan loaded will turn from RED to GREEN.

The LED for the 2nd pan of the same product (3rd pan, etc.) loaded will turn from RED to YELLOW.

An LED timer can be stopped (cancelled) at any time by pressing and releasing the corresponding PAN button quickly 3 times.

Operation (continued)

- 5** When any of the timer LEDs flash, cook more product or remove and discard product as indicated.

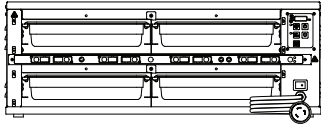

**GREEN** (flashing) = Cook more product  
**YELLOW** (flashing) = Cook more product  
**RED** (flashing) = Discard product

**WARNING**  
Hot surfaces.

- 6** Product, along with any remaining time, can be transferred from one cavity to another as follows:

- A. Press and release the **TRANSFER** button. Displays for available bins are brightly lit. Displays for bins currently not timing, are dimly lit.
- C. Move the product. Press and release the **TRANSFER** button again.

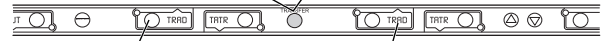

- B. Press and release the **PAN** button of the product to be moved.
- D. Press and release the **PAN** button for the new location. The new location will finish timing the product. When the transferred pan timing expires and/or is cancelled, the location will revert to original menu setting.

*NOTE: If product transfer is not completed within a pre-programmed transfer time, the transfer will be cancelled. See your Manager.*

- 7** To shut down the unit, turn the power On/Off switch to OFF.

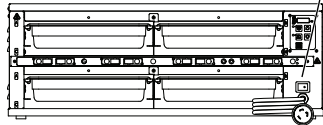

Time Declination Feature

To adjust Hold time when starting a timer:

- A. Press and hold the timer button.  
B. Press the UP or DOWN Arrow button to adjust the Hold time.

*NOTE: This adjustment must be done within the first 5 seconds.*

*NOTE: The range of adjustment cannot be larger than the default hold time or smaller than the default cook time.*

To cancel at any time, press and release the corresponding **PAN** button quickly 3 times.

## Cleaning

**⚠ WARNING**

Before performing any maintenance, turn the power switch to the OFF position and unplug the power cord from the electrical receptacle.

**⚠ CAUTION**

This unit is not watertight. Do not clean with a water jet/jet spray. Do not immerse the unit in water.

1. Turn the unit off and unplug the power cord from the electrical receptacle.
2. Wipe all parts and unit with a damp cloth. DO NOT use a green Scotch Bright pad cleaner, ice or water.

## Setting Temperature

- 1** The unit has two shelves, each with an upper and lower heater (four heaters total).  
Each upper heater has a programmable range of 150° – 350°F (65.6° – 176.7°C).  
Each lower heater has a programmable range of 150° – 260°F (65.6° – 126.7°C).  
Use the control below and the following steps to set the setpoint temperature for each heater.

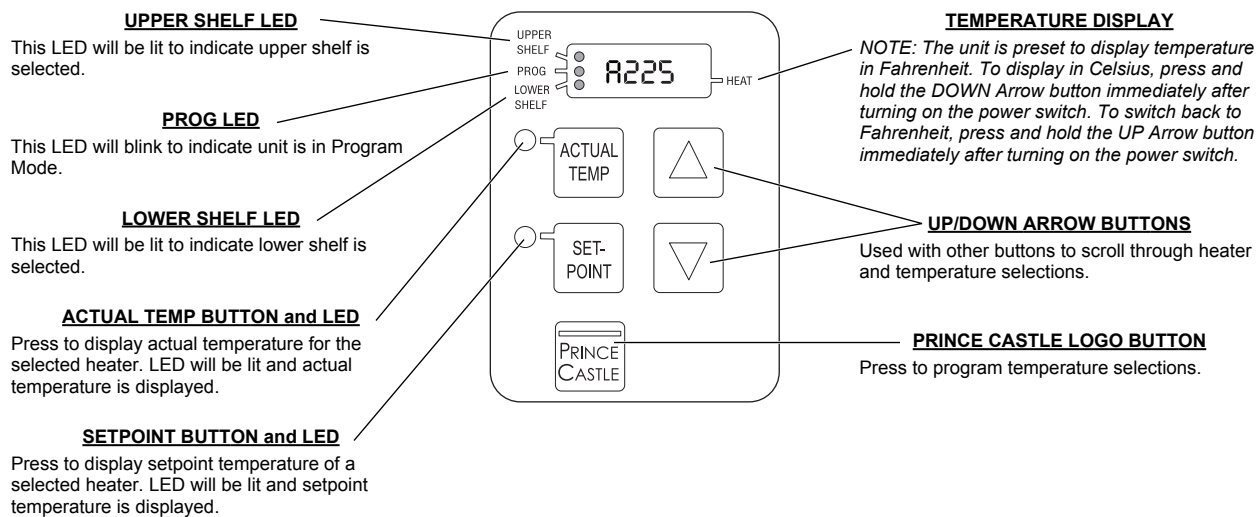

*NOTE: To reset all times and temperatures to the factory settings, turn the unit off, then press and hold the UP and DOWN Arrow buttons simultaneously while turning the unit back on. A "P" will appear in the display and all times and temperatures will be reset to original factory settings.*

**Programming for C & D Heaters for Percentage of Power**

33" Heater — C & D Heaters Are Rope Heaters (All Rope Heaters Are Designated for Bottom Heat Only)

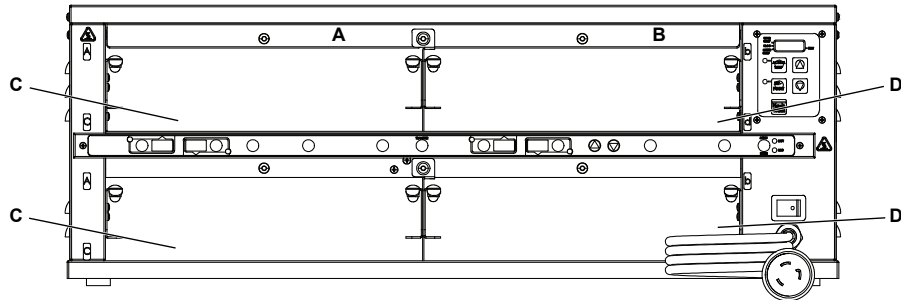

46" Heater — D Heaters Are Rope Heaters (All Rope Heaters Are Designated for Bottom Heat Only)

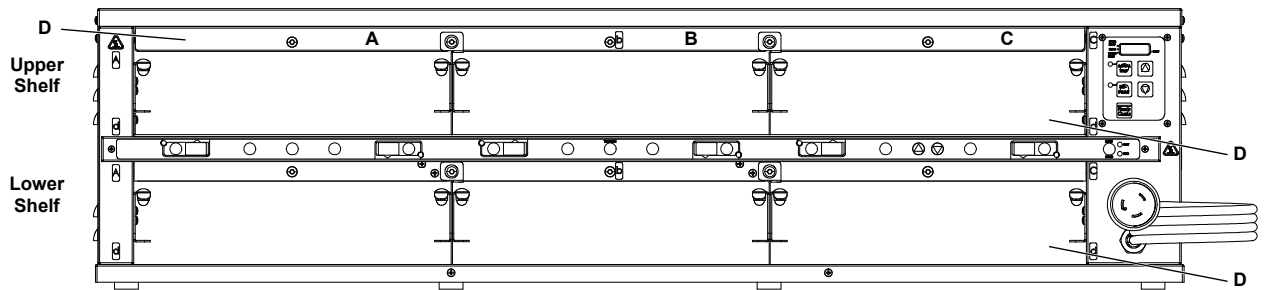

**Programming for C & D Heaters for Percentage of Power (continued)**

**33" Heater — DHB2PT-33KFCEEL**

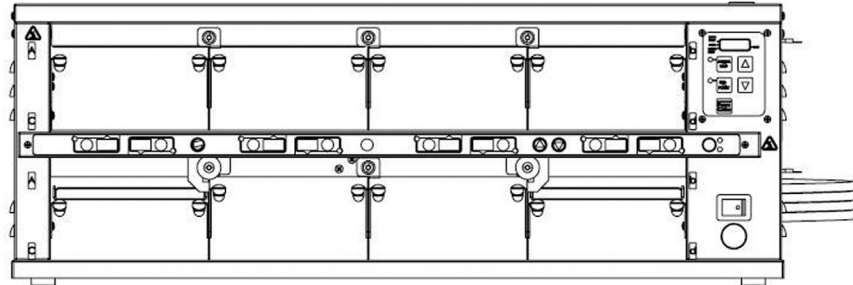

**33" Heater — DHB2PT-33KFCCED**

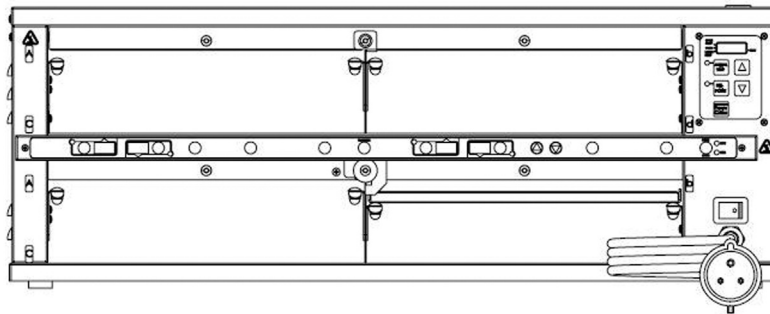

**DHB2PT-33KFCCED Pan Cover**

1. To install or remove the pan cover, move the amber pan simply by raising up the latch and sliding the pan cover in or out.
2. When properly installed, the pan cover should have the edges facing up so the smooth side of the cover rests on top of the amber pan.

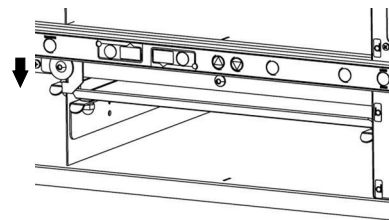
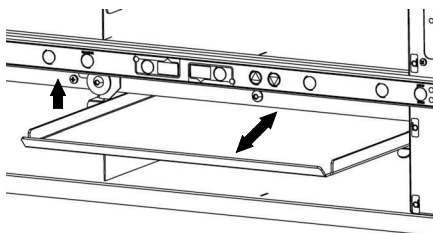

## Control Panel

1

### Displays and Indicators

- The red indicator light next to the UPPER SHELF label indicates that the temperature being displayed is for the selected cavity.
- The red indicator light next to the PROG label blinks when in the Programming Mode.
- The red indicator light next to the LOWER SHELF label indicates that the temperature being displayed is for the selected cavity.
- The red indicator light next to the HEAT label is on when power is applied to the heater zone being displayed on the control panel.
- The red indicator light next to ACTUAL TEMP label is on when the Actual Temperature is being displayed for the heater zone being displayed on the control panel.
- The red indicator light next to SET-POINT TEMP label is on when the Set-Point Temperature is being displayed for the heater zone being displayed on the control panel.
- The digital display shows the shelf and the associated temperature for each heater, for example:  
The display for the upper shelf may show A235 for the UPPER HEATER.

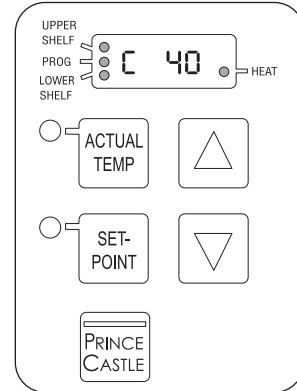

Control Panel

2

### Control Panel Buttons

- **SET-POINT:** The Set-Point temperature is displayed for the selected heaters when this button is pressed during the operating mode. The SET-POINT indicator light is on when the Set-point mode is selected.
- To Program a heater, press and hold the PRINCE CASTLE button then press and hold the SET-POINT button for 5 seconds or until the PROG indicator light turns on. Use the UP and DOWN arrows to change the Set-Point temperature.
- **ACTUAL TEMP:** The Actual Heater temperature is displayed only for the selected heater when this button is pressed in the operating mode.
- **UP ARROW & DOWN ARROW:** When pressed in the operating mode, selects which heater is in the display on the control panel. The indicator light next to the UPPER SHELF or LOWER SHELF is on to indicate which shelf is selected.

## Programming

1

### Upper/Ceiling Heaters in Both Shelves — Programmed for Temperature

The temperature of the Upper Heaters can be adjusted from 150 to 350°F (65.6 to 176.7°C) in one-degree increments (Fahrenheit).

1. Use the UP or DOWN buttons to select Heater A through D in UPPER or LOWER SHELF.
2. Press the SET-POINT button. When the SET-POINT indicator light is on, the digital display shows the Set-Point temperature.
3. To change the temperature setting, press and hold the PRINCE CASTLE LOGO button; then press and hold the SET-POINT button. Hold both buttons until the PROG indicator light turns on.
4. Use the UP and DOWN arrow buttons to change the temperature.
5. Press the PRINCE CASTLE LOGO button to store the new value and to exit the PROGRAMMING mode.

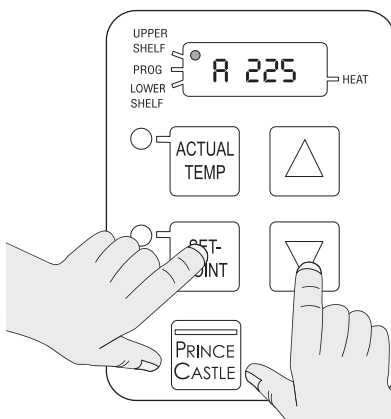

Repeat steps 1 – 5 for other Heaters in both upper and lower shelves.

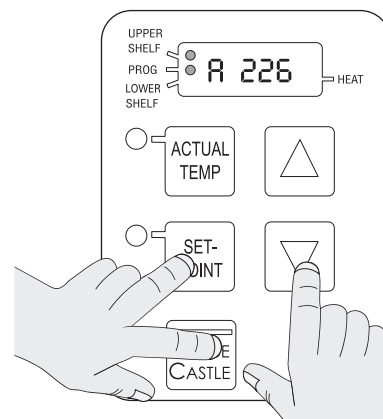

## Calibrating Heaters

- 1** Use the following steps to calibrate the individual heaters.

*NOTE: Allow sufficient amount of time for temperatures to stabilize before starting calibration.*

Press the UP or DOWN Arrow button until the desired heater and upper or lower shelf is selected.

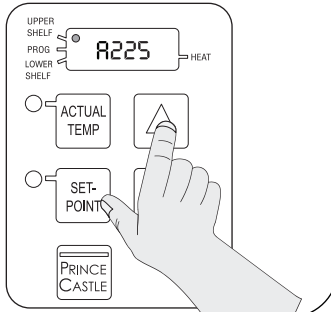

- 2** Take a temperature reading within the shelf near the center of the heater surface.

Use a stand-alone temperature meter (not supplied).



**WARNING**  
Hot surfaces. Use caution when taking temperature readings within the shelf.



- 3** A. Press and hold the PRINCE CASTLE LOGO and ACTUAL TEMP buttons for 5 seconds. The colon (:) LED indicator will light. The temperature displayed is the actual heater temperature sensed by the controller.  
B. To clear any offset readings, press the SETPOINT button.

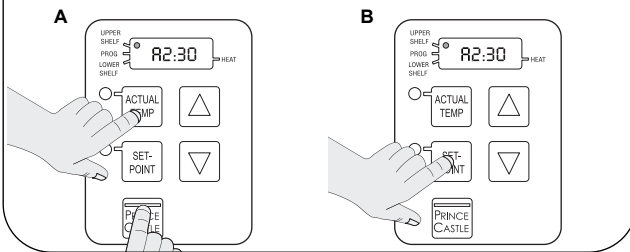

- 4** A. Press the UP or DOWN Arrow button until the temperature displayed matches the reading obtained in Step 2.  
B. Press the PRINCE CASTLE LOGO button to save the temperature value and exit the Calibration Mode.

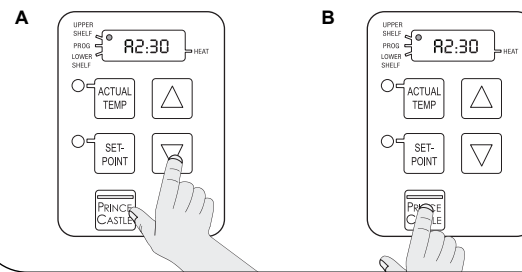

## Selecting Regular Menus

- 1** There are six menus available:  
Menu 1 – 6  
Press and hold the MENU/ENTER button, then use the UP or DOWN Arrow button to scroll through the 6 menus.

When scrolling, menu numbers appear in this display.





- 2** When the desired menu is displayed, release the MENU/ENTER button. The food products for the menu will be displayed in the upper and lower BUN TRAY displays.

When timers for a different menu are still active, the REG LED will flash until they are all cancelled.





## Programming the Menus

- 1** Press and hold the PRINCE CASTLE LOGO button (on the button bar) until all the displays show PROG and the PAN button LEDs all glow RED.
- 

- 2** Press and hold the MENU/ENTER button. The display next to the MENU/ENTER button will show the menu choices. Use the UP or DOWN Arrow button to scroll through the 6 menus. Release the MENU/ENTER button when the desired menu is displayed.
- 

When the MENU/ENTER button is released, all displays will again show PROG.



- 3** A. Press the PAN button next to the display to be changed. The LED will change from RED to YELLOW and the display will change from PROG to the assigned menu item.
- 

- B. Press the UP or DOWN Arrow button to scroll to the desired menu item.  
C. Press the MENU/ENTER button to save the selection. All displays will show PROG.
- 

- 4** A. Repeat Steps 2 and 3 as required.  
B. Press the PRINCE CASTLE LOGO button to exit the Program Mode and return to the Run Mode.

*NOTE: Up to six items (one for each menu) may be programmed for each PAN button. A pan may be set as "not used" by assigning a blank display as its product.*



## Changing the Hold and Cook-More Times

- 1** A. The SET PRODUCT TIME menu is used to change the Hold & Cook-More times.
- B. Press and hold the PRINCE CASTLE LOGO button, then immediately press and hold the MENU/ENTER button until the display shows one of three programming menus.
- C. Use the UP or DOWN Arrow button to scroll to the SET PROD TIME ↑ ↓ menu.



- 2** A. Press and release the MENU/ENTER button to enter the Set Product Time menu. The display will show, for example, EGGS TIME ↓ ↑ ENTR.
- B. Use the UP or DOWN Arrow button to scroll through the list of products. When the desired product is displayed, press the MENU/ENTER button to select it.



*NOTE: Holding the UP or DOWN Arrow button for longer than 2 seconds will cause the product list to automatically scroll up or down.*

- 3** A. The display now shows the current Hold time.
- 
- B. Use the UP or DOWN Arrow button to scroll to the desired Hold time. When the desired Hold time is displayed, press the MENU/ENTER button to save the desired Hold time.



*NOTE: Hold time cannot be reduced to less than the Cook-More time plus one minute.*

- 4** A. The display will now show current Cook-More time. Use the UP or DOWN Arrow button to scroll to the desired Cook-More time.
- 
- B. When the desired Cook-More time is displayed, press the MENU/ENTER button to save it.



*NOTE: Cook-More time cannot be increased to more than the Hold time minus one minute.*

- 5** A. The display will show PROD TIME ↑ ↓ ENTR. Repeat Steps 2 – 4 for any other product.
- B. Press and release the PRINCE CASTLE LOGO button at any time to exit the Program Mode and return to the Run Mode.

*NOTE: If the MENU/ENTER button has not been pressed to save any changes, the program will revert to the original values.*



## Setting the Alternating Display Interval

- A. The Alternating Display Interval allows the timer bar displays to alternate between the product name and remaining Hold time. The default setting is 5 seconds.
- B. Press and hold the PRINCE CASTLE LOGO button, then immediately press and hold the MENU/ENTER button until the display shows one of the programming menus.
- C. Use the UP or DOWN Arrow button to scroll to the DISP ALT TIME menu. Press MENU/ENTER button.
- D. Use the UP and DOWN Arrow buttons to adjust the interval setting from 0 to 15 seconds. Press MENU/ENTER to save the change.
- E. Press and hold the PRINCE CASTLE LOGO button at any time to exit the Program Mode.

*NOTE: Setting the interval to "0" disables the feature and only the product name will be displayed.*



## Changing Product Names

- 1 A. The EDIT PRODUCT NAME menu is used to change a default product name to one of your own choosing.
- B. Press and hold the PRINCE CASTLE LOGO button, then immediately press and hold the MENU/ENTER button until the display shows one of the programming menus.
- C. Use the UP or DOWN Arrow button to scroll to the PROD NAME ↑ ↓ ENTR menu.

PRINCE CASTLE LOGO Button

MENU/ENTER Button

- 2 A. Press and release the MENU/ENTER button to enter the EDIT PRODUCT NAME menu.  
The display will read PROD XXXX ↑ ↓ ENTR.
- B. Use the UP or DOWN Arrow button to scroll through the list of products.
- C. When the desired product is displayed, press the MENU/ENTER button to select it. The first letter (in this case, the E) will start blinking.

- 3 A. To change the blinking E, use the UP or DOWN Arrow button to scroll to the desired letter/number/symbol.
- B. When the desired selection is displayed, press the PAN button (to the left or right of the selected display) to move to the next digit.
- C. Repeat for all digits.

*NOTE: Holding the UP or DOWN Arrow button for longer than 2 seconds will cause the selected digit to automatically scroll up or down.*

- 4 When all four digits have been changed, press the MENU/ENTER button to save the new name.

- 5 A. The display will show PROD NAME ↑ ↓ ENTR. Repeat Steps 2 – 4 for any other product.
- B. Press and release the PRINCE CASTLE LOGO button at any time to exit the Program Mode and return to the Run Mode.

*NOTE: If the MENU/ENTER button has not been pressed to save any changes, the program will revert to the original names.*

## Addendum: Audio

### Audio Capabilities

1. When a PAN button is pressed to activate a timer, the unit will sound a tone.
2. When the timer reaches the "Cook-More" time, an alarm will sound for 5 seconds.
3. When the timer has counted down completely, an alarm will sound continuously until it is manually shut off by pressing the appropriate pan button. The product in that pan should be discarded at this time.

## Set Maximum Transfer Time

- The SET MAXIMUM TRANSFER TIME menu is used to set the amount of time allowed to make a product transfer from one pan to another.
  - Press and hold the PRINCE CASTLE LOGO button, then immediately press and hold the MENU/ENTER button until the display shows one of the programming menus.
  - Use the UP or DOWN Arrow button to scroll to the XFR TIME ↑ ↓ ENTR menu. (*NOTE: Units with 6 or 8 pan displays will show MAX XFR TIME ↑ ↓ ENTR.*)

PRINCE CASTLE LOGO Button

MENU/ENTER Button

- Press and release the MENU/ENTER button to enter the SET MAXIMUM TRANSFER TIME menu.
  - The display shows XFR :20 ↑ ↓ ENTR. This shows a value of 20 seconds.

- To change the time, use the UP or DOWN Arrow button to scroll to the desired time. When the desired selection is displayed, press the MENU/ENTER button to enter the selection.
  - Press and release the PRINCE CASTLE LOGO button at any time to exit the Program Mode and return to the Run Mode.  
*NOTE: If the MENU/ENTER button has not been pressed to save any changes, the program will revert to the original time.*

## Set Volume Level

- The default setting for the volume level is OFF.
  - Press and hold the PRINCE CASTLE LOGO button, then immediately press and hold the MENU/ENTER button until the display shows one of the programming menus.
  - Use the UP or DOWN Arrow button to scroll to the Set Vol 0 ↑ ↓ ENTR menu.

PRINCE CASTLE LOGO Button

MENU/ENTER Button

- Press and release the MENU/ENTER button to enter the Set Volume menu.
  - The display shows SET VOL 0 ↑ ↓ ENTR. This shows that the volume is currently turned off.  
The volume may be set for Vol 0 (off) or for volume levels Vol 1 through Vol 3.

- To change the volume level, use the UP or DOWN Arrow button to scroll to the desired level. When the desired selection is displayed, press the MENU/ENTER button.
  - Press and release the PRINCE CASTLE LOGO button at any time to exit the Program Mode and return to the Run Mode.  
*NOTE: If the MENU/ENTER button has not been pressed to save any changes, the program will revert to the original volume level.*

**CastleNet® Communications Network**

The Prince Castle DHB Bins, external timers, and New Bun Cabinet Timers can be inter-connected to form the CastleNet® Communication Network. The network can be used for data transfer between bins and timers for menu updates or to transfer product hold time from bin-to-bin. A PDA (or similar device) or a notebook with Prince Castle MenuView® software is used to connect to the network and enter the desired changes.

Each bin is supplied with a standard 25' cable and allows units to be "daisy-chained" together to form the network. If cable is too short, use Prince Castle Extender Cable Kit, P/N PC-COMEXT.

The factory default address for Main bins and timers is address 1. The factory default address for Specialty bins and timers is address 2. If a third bin is used, the address must be set at 3.

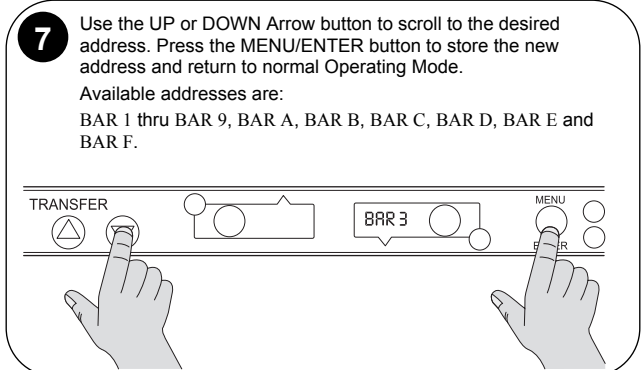
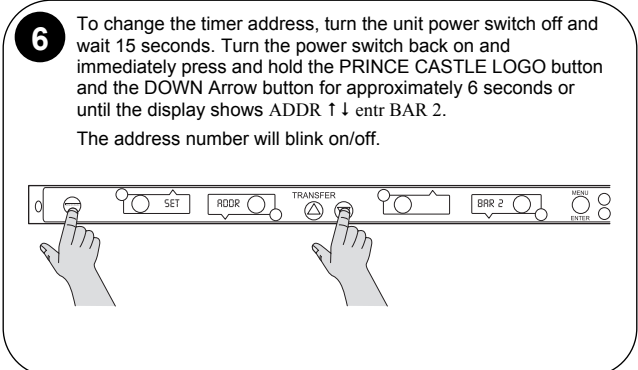
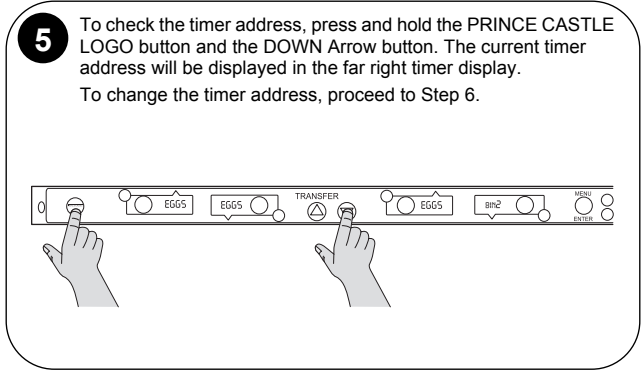
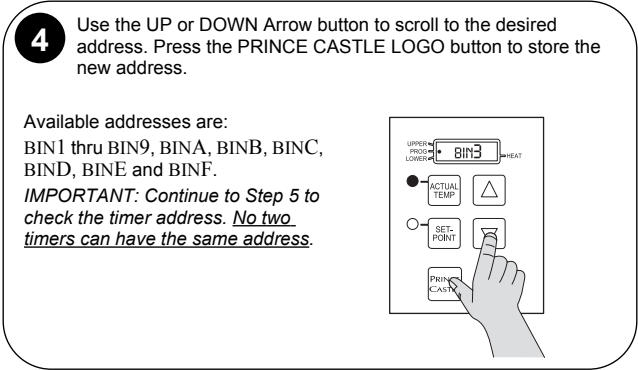
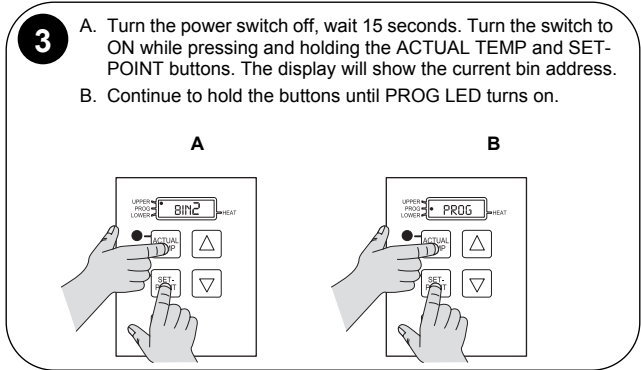
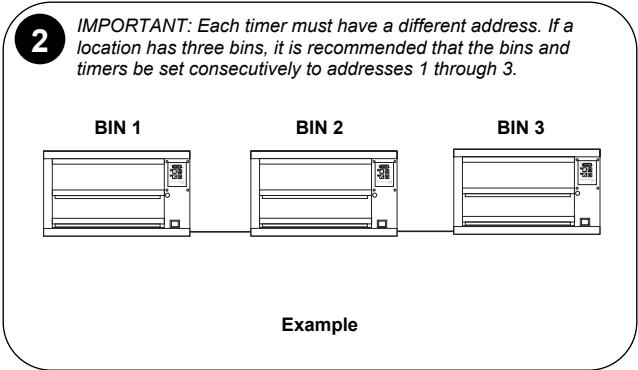
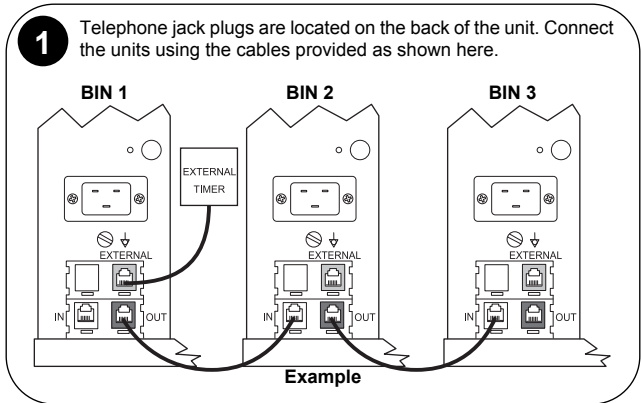

**Exploded View**

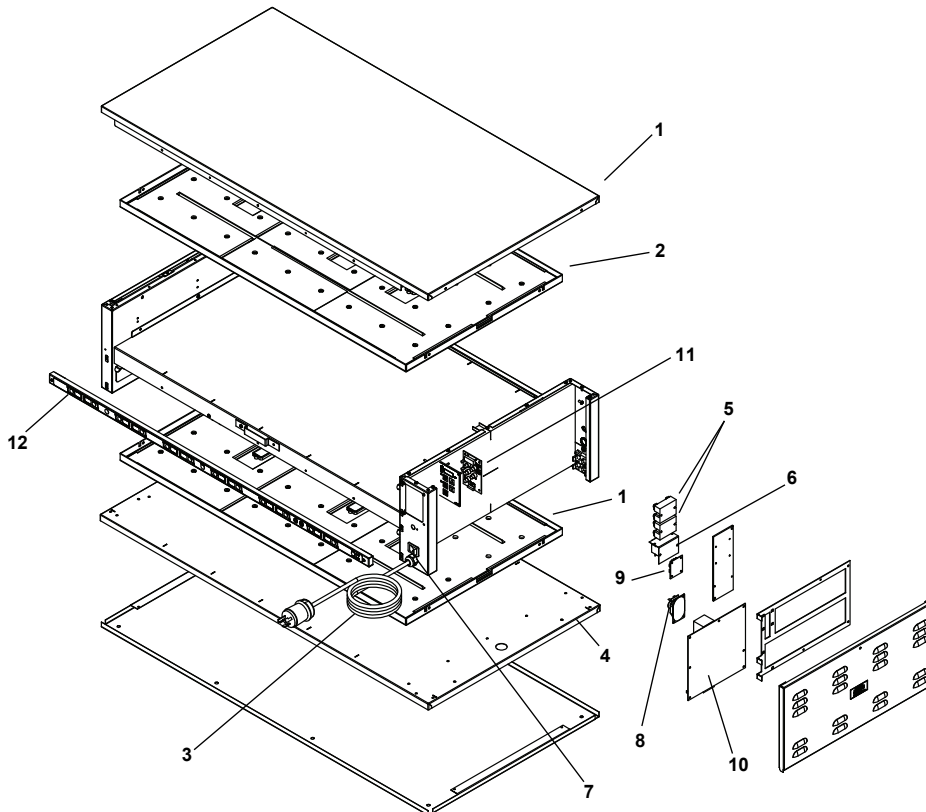

**Model DHB2PT-33KFC, 33WS, 33KFCCE, 33KFCCEL, 33CEN and 33CED**

Ref.	No.	Description
1	540-640S	Upper Heater
2	540-485S	Upper Shelf, Lower Rope Heater
3	72-428S	Power Cord Assy. (33KFC) (33WS)
3	72-426S	Power Cord Assy. (33KFCCE) (33KFCEN)
3	72-433S	Power Cord Assy. (33KFCCEL)
4	540-467S	Base (Rope Heater)
5	Not Applicable	
6	Not Applicable	
7	78-184S	Power Switch
8	88-709-2-11S	Speaker Assy.
9	740-650S	PCB Audio Interface
10	541-1042S	Main PCB (33KFC)
10	541-1079S	Main PCB (33KFCCE) (33KFCEN)
10	541-1137S	Main PCB (33KFCCEL)
10	541-1073S	Main PCB (33WS)
11	541-719S	Display PCB
12	541-1100S	Timer Bar, 8CH, Main (33KFC)
12	541-1067S	Timer Bar, 8CH, Main (33WS) (No Aux for 33WS)
12	541-1075S	Timer Bar, 4CH, Main (33KFCCE)
12	541-1160S	Timer Bar, 8CH, Main (33KFCCEL)
*	541-1196	Timer Bar, 8CH, Main (33KFCCEL)
*	541-1101S	Timer Bar, 4CH, Aux (33KFC)
*	541-1076S	Timer Bar, 4CH, Aux (33KFCCE)
*	541-1161S	Timer Bar, 8CH, Aux (33KFCCEL)
*	541-1197	Timer Bar, 8CH, Aux (33KFCCEL)
*	197-232S	Rubber Feet (Pkg of 4)
*	536-802S	Overlay, Display

\*Part not shown

**Model DHB2PT-46KFC, 46KFCCE, 46KFCCEL, 46CEN and 46CED**

Ref.	No.	Description
1	540-647S	Upper Heater
2	540-492S	Upper Shelf Rope Heater
3	72-356S	Power Cord Assy. (46KFC)
3	72-426S	Power Cord Assy. (46KFCCE) (46KFCEN)
3	72-433S	Power Cord Assy. (46KFCCEL)
4	540-484S	Base (Rope Heater)
5	65-058S	Relay, SSD
6	65-063-06S	Relay, Mechanical
7	78-184S	Power Switch
8	88-709-2-11S	Speaker Assy.
9	740-650S	PCB Audio Interface
10	541-1043S	Main PCB (46KFC)
10	541-1080S	Main PCB (46KFCCE) (46KFCEN)
10	541-1139S	Main PCB (46KFCCEL)
11	541-719S	Display PCB
12	541-1102S	Timer Bar, 6CH, Main (46KFC)
12	541-1077S	Timer Bar, 6CH, Main (46KFCCE)
12	541-1049S	Timer Bar, 12CH, Main (46KFCCEL)
12	541-1176S	Timer Bar, 12CH, Main (46KFCF12)
12	541-1198S	Timer Bar, 12CH, Main (46KFCCEL)
*	540-721S	Single Cover Retainer Kit (All Models)
*	540-727S	Dual Cover Retainer Kit (All Models)
*	540-758S	2/4 All Pan Covers (Pkg of 2)
*	540-691S	1/1 All Pan Covers (Pkg of 2)
*	540-737S	Single/Dual Lid Stop
*	540-461S	Divider, No Lid (All Models)
*	541-1103S	Timer Bar, 6CH, Aux (46KFC)
*	541-1078S	Timer Bar, 6CH, Aux (46KFCCE)
*	541-1050S	Timer Bar, 12CH, Aux (46KFCCEL)
*	541-1199S	Timer Bar, 12CH, Aux (46KFCCEL)
*	66-045S	Strain Relief
*	197-232S	Rubber Feet (Pkg of 4)
*	536-802S	Overlay, Display
*	540-753S	Kit, Side Guide (L & R)
*	88-612S	RFI Filter

Wiring Diagrams

**Model DHB2PT-33KFC Series**

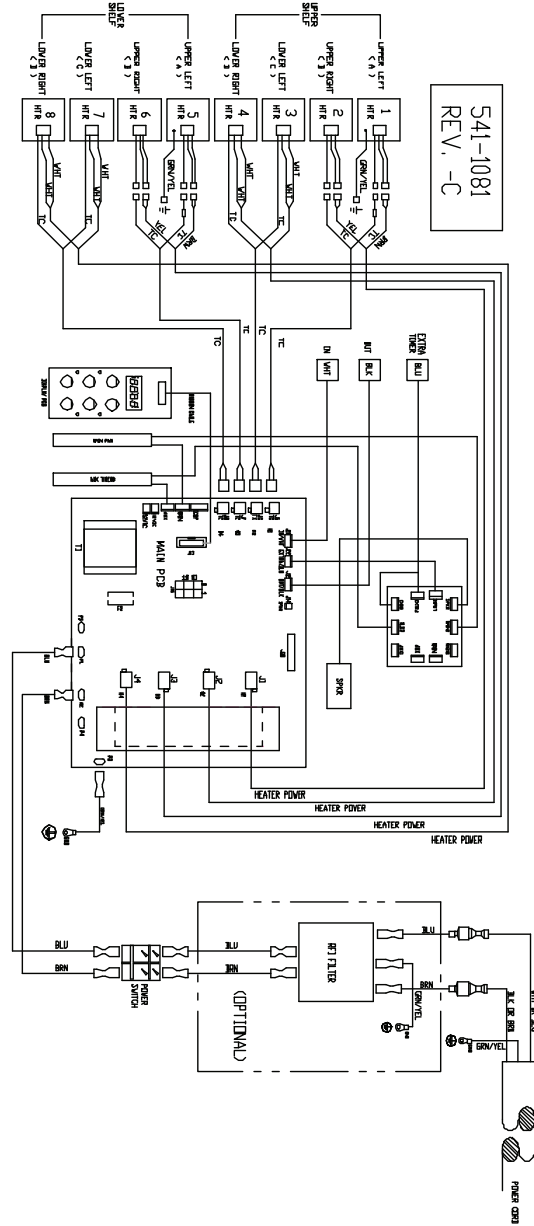

**Wiring Diagrams (continued)**



**Product Holding Bin**  
**DHB2PT-YUM Series**

---