Owner's Manual



Product Holding Unit

U.S. Patents 6175099, 6262394

中国专利 00805894.6

Other U.S. and Foreign Patents Pending

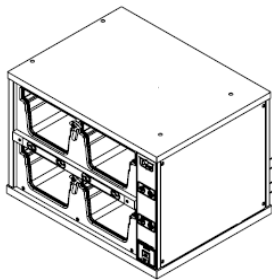

FWM34-22

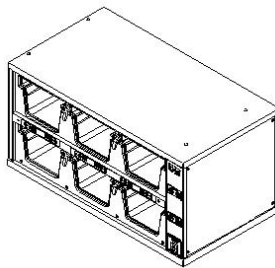

FWM34-23

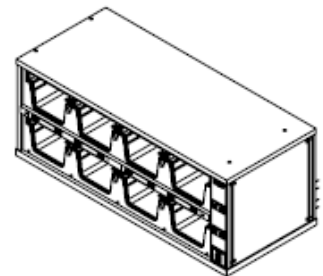

FWM34-24

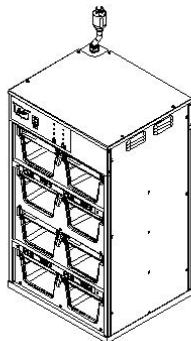

FWM34-42

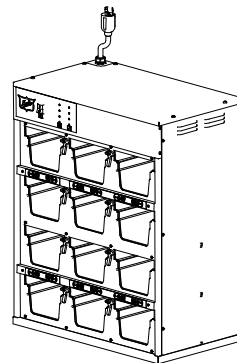

FWM34-43

**IMPORTANT INFORMATION
READ BEFORE USE
PLEASE SAVE THESE INSTRUCTIONS**



"Your Solutions Partner"

DUKE MANUFACTURING CO.
Broadway • St. Louis, MO 63102
800.735.3853 • 314.231.1130 • 314.231.5074 Fax
www.dukemfg.com

157751F

Contents

Manufacturing Introduction..... 2
Safety Instruction..... 3
Spec Sheets..... 4-8
Installation Instructions..... 9
Operating Instructions..... 10-15
Programming with PDA 16-18
Cleaning and Care..... 19
Troubleshooting 20-21
Parts List and Illustration 22-23
Wiring Diagram..... 24
Customer Assistance 25

Manufacturer’s Introduction

The Duke Product Holding Unit (PHU) was developed for extended food-holding capabilities to provide consistently high, “just cooked” food quality.

The Duke Product Holding Unit utilizes Duke’s patented “Heat Sink” holding technology that provides even heat distribution to food pans through the bottom and sides. This allows pre-cooked foods to be held for extended periods without noticeable degradation of quality, reducing food scrap/waste.

The self contained, individually formed, sealed compartments of the Duke Product Holding Unit eliminates food odor and taste transfer. Because the compartments are sealed and formed to the shape of the pan, no disassembly is required for cleaning and product changes.

The unique design of the Duke Product Holding Unit allows single temperature operation for all existing product groups. This 190°F approved temperature is preset at the factory. This reduces the likelihood of inconsistent performance between restaurant locations.

The Duke Product Holding Cabinet was also designed to rethermalize food product. A thermostat setting of 200°F minimum is required for rethermalization. See instructions on page 10 for thermostat adjustment.

NOTE: Only qualified service persons should modify control temperature presets

Manufacturer: Duke Manufacturing Co.
 Address: 2305 N. Broadway
 St. Louis, MO 63102

Model numbers	
FWM34-22-120	FWM34-23-120
FWM34-22-208	FWM34-23-208
FWM34-22-230	FWM34-23-230
FWM34-24-120	FWM34-42-120
FWM34-24-208	FWM34-42-208
FWM34-24-230	FWM34-42-230
FWM34-43-208	
FWM34-43-230	

Serial #: _____

Date Received: _____

Date Installed: _____

Telephone: (800) 735-DUKE (3853)
 (314) 231-1130

Fax: (314) 231-5074

Service Referral #: _____

Local Service Name _____

Local Service Number _____



Important Safety Instructions

Throughout this manual, you will find the following safety words and symbols that signify important safety issues with regards to operating or maintaining the equipment.



WARNING

GENERAL WARNING. Indicates information important to the proper operation of the equipment. Failure to observe may result in damage to the equipment and/or severe bodily injury or death.



WARNING

ELECTRICAL WARNING. Indicates information relating to possible shock hazard. Failure to observe may result in damage to the equipment and/or severe bodily injury or death.



CAUTION

GENERAL CAUTION. Indicates information important to the proper operation of the equipment. Failure to observe may result in damage to the equipment.



WARNING

HOT SURFACE WARNING. Indicates information important to the handling of equipment and parts. Failure to observe caution could result in personal injury

In addition to the warnings and cautions in this manual, use the following guidelines for safe operation of the unit.

- Read all instructions before using equipment.
- For your safety, the equipment is furnished with a properly grounded cord connector. Do not attempt to defeat the grounded connector.
- Install or locate the equipment only for its intended use as described in this manual. Do not use corrosive chemicals in this equipment.
- Do not operate this equipment if it has a damaged cord or plug, if it is not working properly, or if it has been damaged or dropped.
- This equipment should be serviced by qualified personnel only. Contact the nearest Duke authorized service facility for adjustment or repair.
- Do not block or cover any openings on the unit.
- Do not immerse cord or plug in water.
- Keep cord away from heated surfaces.
- Do not allow cord to hang over edge of table or counter.

The following warnings and cautions appear throughout this manual and should be carefully observed.

- Turn the unit off, disconnect the power source and allow unit to cool down before performing any service or maintenance on the unit.
- The procedures in this manual may include the use of chemical products. You must read the Material Safety Data Sheets before using any of these products.
- The unit should be grounded according to local electrical codes to prevent the possibility of electrical shock. It requires a grounded receptacle with separate electrical lines, protected by fuses or circuit breaker of the proper rating.
- Disposal of the unit must be in accordance with local environmental codes and/or any other applicable codes.

SAVE THESE INSTRUCTIONS



"Your Solutions Partner"

Duke Manufacturing Co.
2305 N. Broadway • St. Louis, MO 63102
800.735.3853 • 3.231.1130 • 314.231.5074 Fax
www.dukemfg.com

Page 3 of 25

Specification Sheet

Model FWM34-22

Shipping Weight:	61lbs/27.7 Kg (Net Weight)	
Electrical	FWM34-22-120	120 V, 6.7 A, 800 W, 50/60 Hz
	FWM34-22-208	208 V, 5.8 A, 1200 W, 50/60 Hz
	FWM34-22-230	230 V, 5.2 A, 1200 W, 50/60 Hz

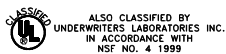
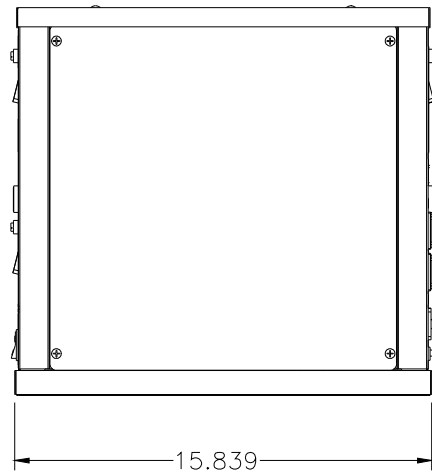
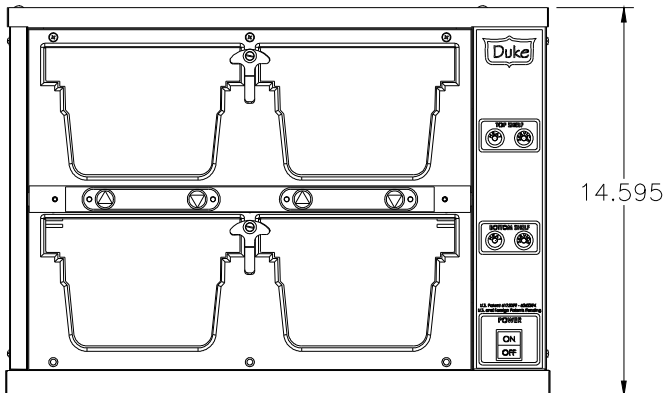
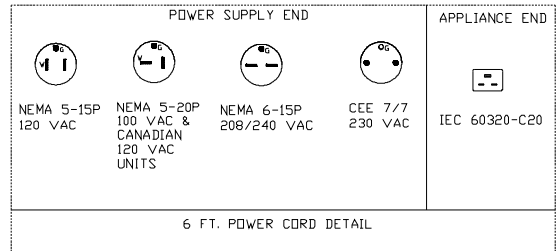
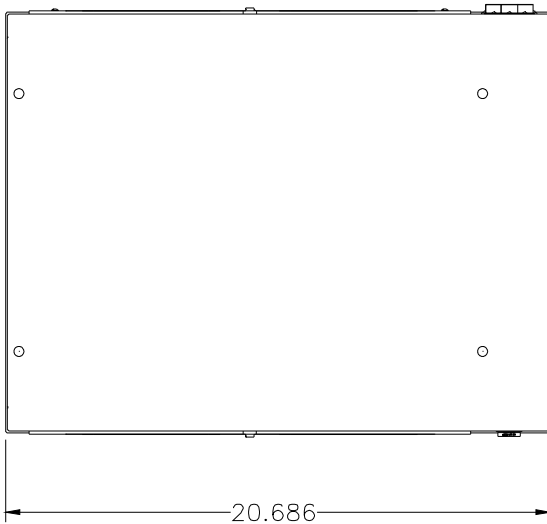

"Your Solutions Partner"

Duke Manufacturing Co.
 2305 N. Broadway • St. Louis, MO 63102
 800.735.3853 • 3.231.1130 • 314.231.5074 Fax
www.dukemfg.com

Specification Sheet

Model FWM34-23

Shipping Weight:	83.5lbs/37.39 Kg (Net Weight)	
Electrical	FWM34-23-120	120 V, 10.0 A, 1200 W, 50/60 Hz
	FWM34-23-208	208 V, 8.7 A, 1800 W, 50/60 Hz
	FWM34-23-230	230 V, 7.8 A, 1800 W, 50/60 Hz

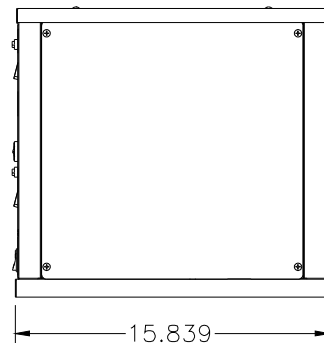
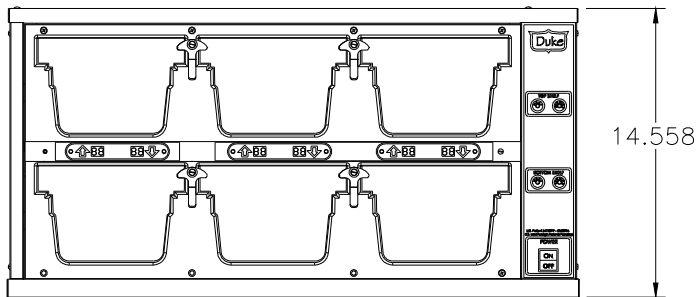
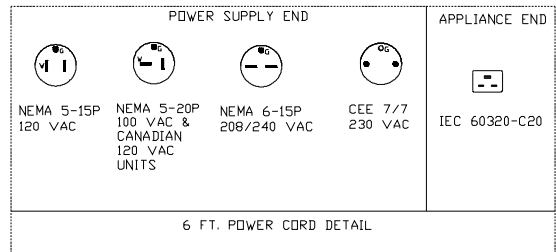
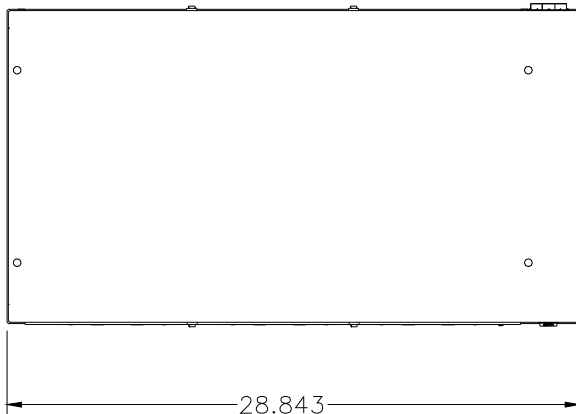

CLASSIFIED
 ALSO CLASSIFIED BY
 UNDERWRITERS LABORATORIES INC.
 IN ACCORDANCE WITH
 NSF NO. 4 1999



"Your Solutions Partner"

Duke Manufacturing Co.
 2305 N. Broadway • St. Louis, MO 63102
 800.735.3853 • 3.231.1130 • 314.231.5074 Fax
 www.dukemfg.com

Specification Sheet

Model FWM34-24

Shipping Weight:	100lbs/45 Kg (Net Weight)	
Electrical	FWM34-24-120	120 V, 13.3 A, 1600 W, 50/60 Hz
	FWM34-24-208	208 V, 11.5 A, 2400 W, 50/60 Hz
	FWM34-24-230	230 V, 10.4 A, 2400 W, 50/60 Hz

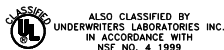
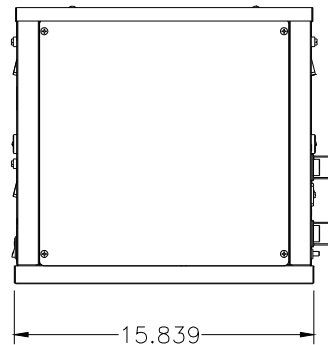
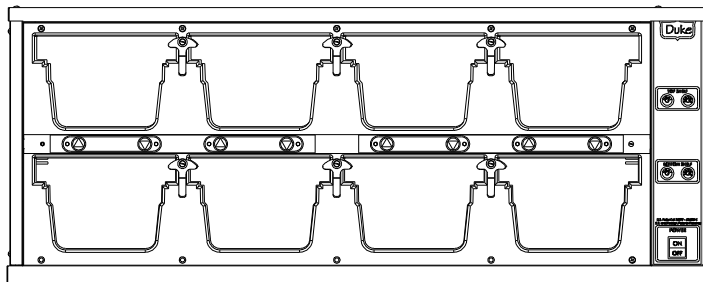
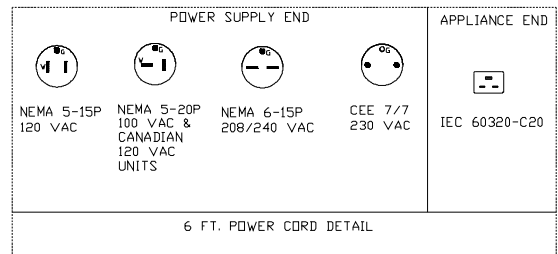
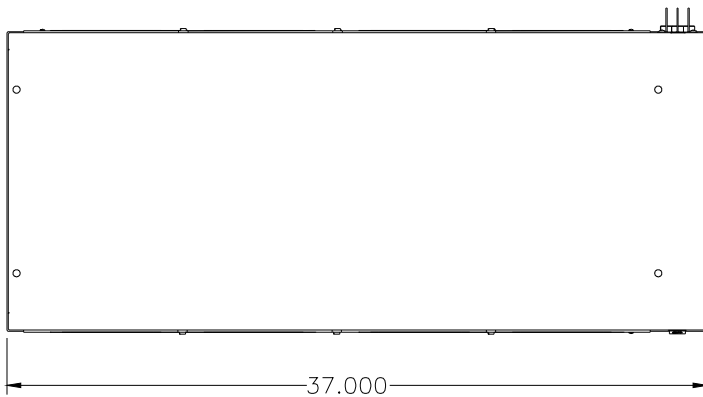

"Your Solutions Partner"

Duke Manufacturing Co.
2305 N. Broadway • St. Louis, MO 63102
800.735.3853 • 3.231.1130 • 314.231.5074 Fax
www.dukemfg.com

Specification Sheet

Model FWM34-42

Shipping Weight:	100lbs/45 Kg (Net Weight)	
Electrical	FWM34-42-120	120 V, 13.3 A, 1600 W, 50/60 Hz
	FWM34-42-208	208 V, 11.5 A, 2400 W, 50/60 Hz
	FWM34-42-230	230 V, 10.4 A, 2400 W, 50/60 Hz

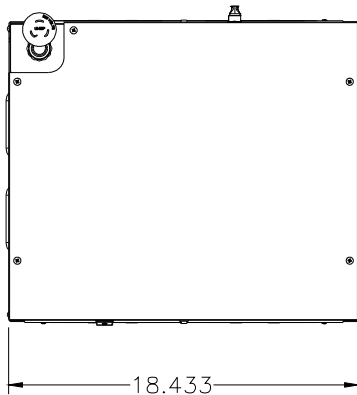

L6-30P
Twist Lock Plug



IEC 60309
3 Pin & Sleeve Plug

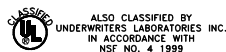
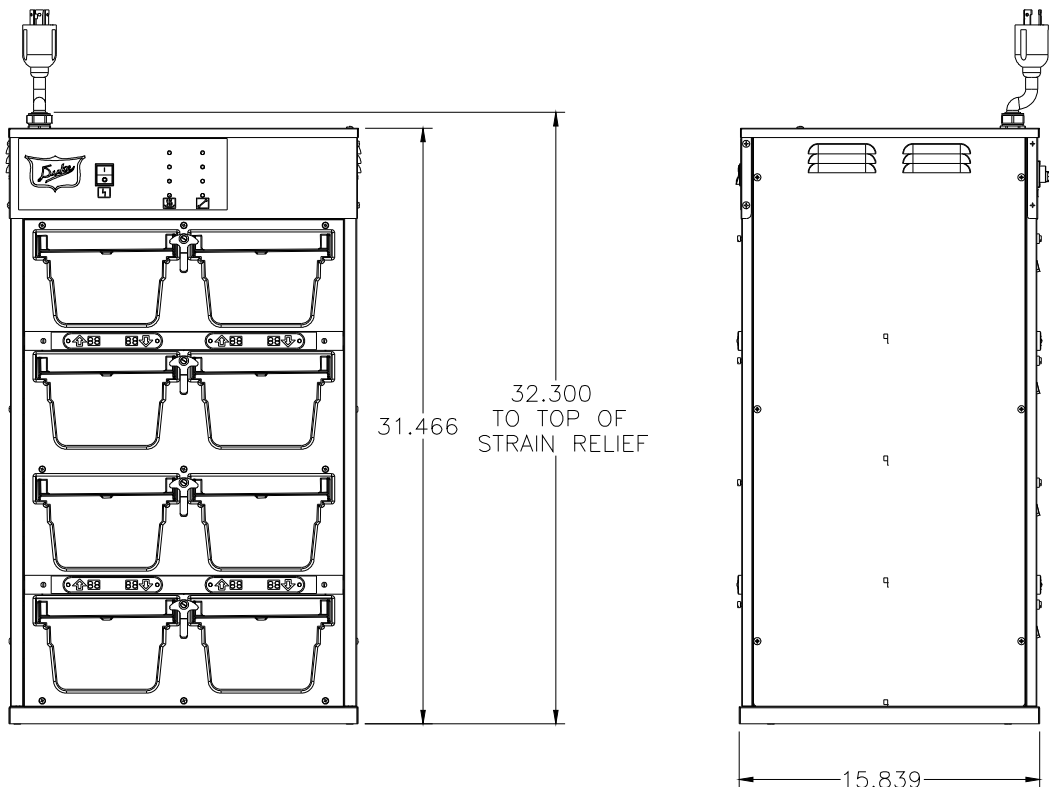

"Your Solutions Partner"

Duke Manufacturing Co.
2305 N. Broadway • St. Louis, MO 63102
800.735.3853 • 3.231.1130 • 314.231.5074 Fax
www.dukemfg.com

Specification Sheet

Model FWM34-43

Shipping Weight:	180lbs/81.6 Kg (Net Weight)	
Electrical	FWM34-43-208	208 V, 17.3 A, 3600 W, 50/60 Hz
	FWM34-43-230	230 V, 15.7 A, 3600 W, 50/60 Hz

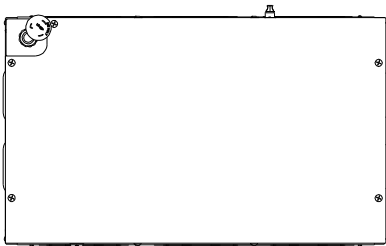

L6-30P
Twist Lock Plug

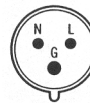

IEC 60309
3 Pin & Sleeve Plug

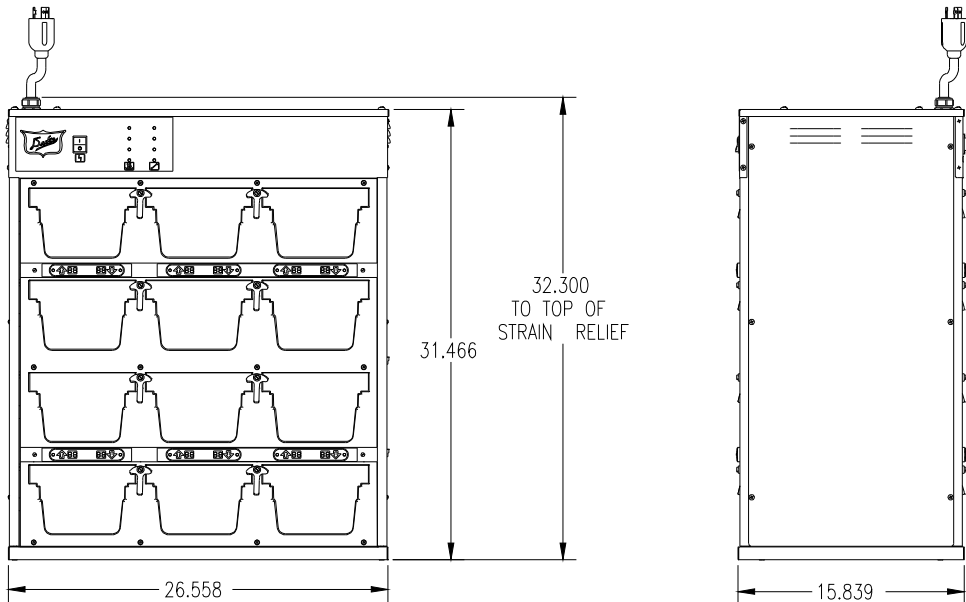

LISTED
COMMERCIAL
COOKING
APPLIANCE



INDEXER
COMMERCIAL
APPAREL
DE QUISINE



ALSO CLASSIFIED BY
UNDERWRITERS LABORATORIES INC.
IN ACCORDANCE WITH
NSF NO. 4 1999



"Your Solutions Partner"

Duke Manufacturing Co.
2305 N. Broadway • St. Louis, MO 63102
800.735.3853 • 3.231.1130 • 314.231.5074 Fax
www.dukemfg.com

Installation

Unpacking Unit

- Inspect the shipping carton and/or container, carefully noting any exterior damage on the delivery receipt, which was not evident on the outside of the shipping container (concealed damage). Contact the carrier immediately and file a damage claim with them. Save all packing materials when filing a claim. Freight damage claims are the responsibility of the purchaser and are not covered by the warranty.
- Inspect unit for damage.
- Report any dents or breakage to source of purchase immediately.
- **Do not attempt to use unit if damaged.**
- Remove all materials from unit interior.
- If unit has been stored in extremely cold area, wait a few hours before connecting power.

Unit Placement

- Do not install unit next to or above source of heat, such as oven or deep fat fryer.
- Install unit on level countertop surface.
- Outlet should be located so that plug is accessible when unit is in place.
- The following minimum clearances must be maintained between the PHU and any combustible or non-combustible substance:

Unit	Clearance
Right Side	0"
Left Side	0"
Rear	8"
Floor	0"

Proper airflow around unit cools electrical components. With restricted airflow, unit may not operate properly and life of electrical parts is reduced.

WARNING

To avoid risk of electrical shock or death, this unit must be grounded and plug must not be altered.

Earthing Instructions

Unit MUST be grounded.

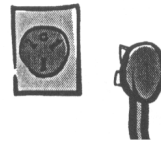

Grounding reduces risk of electric shock by providing an escape wire for the electric current if an electrical short occurs. This unit is

equipped with a cord having a grounding wire with a grounding plug. The plug must be plugged into a receptacle that is properly installed and grounded.

Consult a qualified electrician or servicer if grounding instructions are not completely understood, or if doubt exists as to whether the oven is properly grounded.

Do not use an extension cord. If the product power cord is too short, have a qualified electrician install a three-slot receptacle. This unit should be plugged into a separate circuit with the electrical rating as provided in product specifications.

External Equipotential Earthing Terminal (export only)

Equipment has secondary earthing terminal. Terminal provides external earthing connection used in addition to earthing prong on plug. Located on outside of oven back, terminal is marked with this symbol.



"Your Solutions Partner"

Duke Manufacturing Co.
2305 N. Broadway • St. Louis, MO 63102
800.735.3853 • 3.231.1130 • 314.231.5074 Fax
www.dukemfg.com

Page 9 of 25

Operating Instructions

Control Programming

The electronic temperature control is pre-set at the factory to maintain the temperature at the bottom center of the pan cavity at 190°F +/- 5°F. This temperature is the result of many hours of laboratory food testing. There are no operator temperature adjustments that can be made. Because the electronic control uses a platinum type RTD sensor, routine calibration is not required.

**! DANGER !
LIVE ELECTRICAL COMPONENTS.
ONLY QUALIFIED SERVICE PERSONS SHOULD MODIFY CONTROL
TEMPERATURE PRESETS.**

1. Remove cover from top of the Product Holding Unit and turn the unit on.
2. Locate the pushbutton S1 and S2 on the control. (see Figure 1.1)
3. Press and hold S1 until any LED on the front of the unit illuminates. (approximately 5 seconds)
4. Observe the front of the unit (Figure 1.2). Press and release S1 on the temperature control until the desired light on the front of the unit flashes.

NOTE: To comply with NSF Sanitation requirements, do not set the control preset temperature below 190°F.

5. Press and release S2 until the sum of the LED values illuminated on the temperature control match the desired pre-set temperature.
6. Repeat steps 4 and 5 for each pre-set temperature then press and hold S1 until no LED on the temperature control board is illuminated and the lights on the front of the unit no longer flash.
7. Replace cover on the top of the Product Holding Unit.

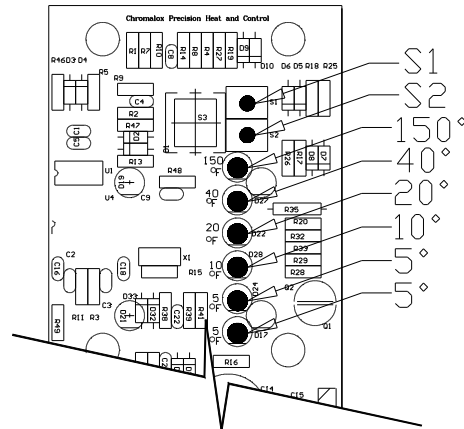

REAR OF UNIT

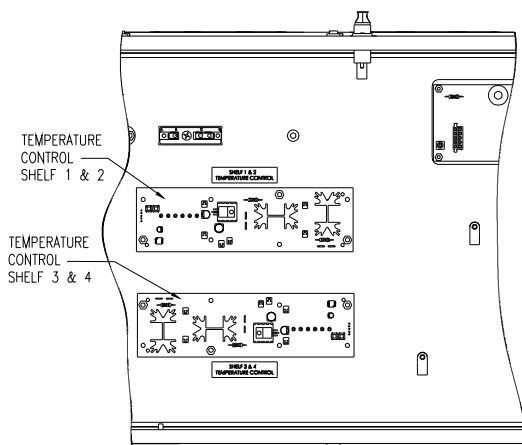

NOTE:

The Temperature Controller for this unit consists of two control boards as shown, which are designated for either Shelf 1 & 2 or Shelf 3 & 4



"Your Solutions Partner"

Duke Manufacturing Co.
2305 N. Broadway • St. Louis, MO 63102
800.735.3853 • 3.231.1130 • 314.231.5074 Fax
www.dukemfg.com

Page 10 of 25

Operating Instructions

NOTE: Before you start, turn off the power to the PHU (Product Holding Unit), and then back on. All the lights should be RED.

NOTE: Always stand on the front side of the warmer facing the ON/OFF switch.

IMPORTANT:

1. Shelves 1 & 2 are programmed using the top timer bar.
2. Shelves 3 & 4 are programmed using the bottom timer bar.

In all programming modes, you will see RED FLASHING LEDs on both the Top & Bottom timer bars, however you only change values when pressing the arrow keys on the specific top or bottom timer bars.

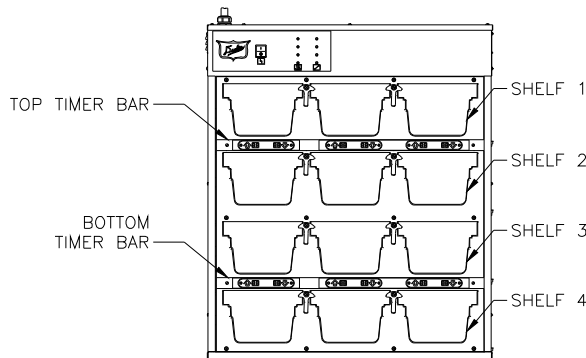

The buttons and lights on the 2, 3 and 4-wide Pan Status timer bar of each PHU are used to modify the HOLD, COOK WARNING and pan LINK settings. HOLD, COOK WARNING and LINKING can be modified by using a Palm Pilot® or by the manual-programming mode described below.

For the 2 and 3-wide timer bar, HOLD and COOK WARNING times for each pan can be set from 5 minutes to 9 ½ hours in 5-minute increments up to 4 hours, and after 4 hours in ½ hour increments (see Table 1). The COOK WARNING time has a 3-minute default time. Additionally, you can change which pans that are LINKED with the same product type. When a HOLD time is changed, the COOK WARNING time defaults to 3 minutes. The COOK WARNING time can then be changed using the Manual Programming Method.

Each timer bar must be programmed individually. In order to program HOLD or COOK WARNING times, you must be in front of the PHU to be programmed. The front is the side with the temperature control label and on/off switch. The left and right sides are referenced from the front view. After entering the HOLD or COOK WARNING programming mode, all timer bars are in this mode.

NOTE: Only one person may press keys on the timer bar being programmed.

1 - Programming HOLD Times for 2 & 3-wide timer bar:

- a) Stand directly in front of the PHU you desire to program. **Simultaneously** press the 3 buttons on the left side of the Pan Status timer bar, (either top or bottom timer bar) see Figure 1 or 2. Notice that the far left LED is RED FLASHING. This indicates you are programming PAN 1. The digital display will indicate the current HOLD time for this PAN.
To modify the HOLD time:
The far right UP arrow key increases the hold time by 5 minutes.
The far right DOWN arrow key decreases the time by 5 minutes.
- b) To advance to the next pan, press the far left UP arrow key. The current times will be displayed on the digital display. The RED FLASHING LED will indicate the current active pan.
- c) To EXIT the time programming mode in the 2 or 3-wide timer bar, press the 3 far left buttons simultaneously and release. All pans with HOLD times greater than ZERO will display a RED light. Pan lights with a HOLD time equal to ZERO do not light and product should not be placed in those pans.



"Your Solutions Partner"

Operating Instructions

2 - Programming HOLD Times for 4-wide timer bar:

a) Stand directly in front of the PHU you desire to program. **Simultaneously** press the leftmost 2 pair of buttons (4 buttons) on the timer bar (skip the Daypart button), and release them all (see Figure 3). The alphanumeric display for each pan will show its current HOLD time in minutes (see table 1). Notice that the leftmost light on the Timebar is FLASHING RED; this indicates you are programming PAN 1. Also the remaining lights will be illuminated to indicate the current HOLD time as described in Section 7.

To modify the HOLD time:

The 2nd from right button on the timer bar increases the HOLD time by 5 minutes, or 30 minutes if the HOLD time is 240 minutes or greater.

The far right button on the timer bar decreases the HOLD time by 5 minutes, or 30 minutes if the HOLD time is greater than 240 minutes.

b) To advance to the next pan, press the far left button on the timer bar. The next pan's light will be FLASHING RED.

c) To EXIT the HOLD time programming mode, simultaneously press the leftmost 2 pair of pan buttons (4 buttons) on the timer bar (skip the Daypart button), and release them all. The NAME of each pan will appear in the alphanumeric displays. The lights of all pans with HOLD times greater than ZERO will be RED. The lights of pans with a HOLD time equal to ZERO will be off and product should not be placed in those pans.

3 - Programming COOK WARNING Times for 2 & 3-Wide timer bar:

a) Stand directly in front of the PHU you desire to program. Simultaneously press the 2 middle buttons on the Pan Status timer bar (either top or bottom timer bar) see Figure 1 or 2. Notice that the far left LED is RED FLASHING. This indicates you are programming PAN 1. The digital display will indicate the current HOLD time for this PAN.

To modify the COOK WARNING time:

The far right UP arrow key increases the hold time by 5 minutes.

The far right DOWN arrow key decreases the time by 5 minutes.

b) To advance to the next pan, press the far left UP arrow key. The current times will be displayed on the digital display. The RED FLASHING LED will indicate the current active pan.

c) To EXIT the time programming mode in the 2 and 3-wide timer bar, press the 3 far left buttons simultaneously and release. All pans with HOLD times greater than ZERO will display a RED light. Pan lights with a HOLD time equal to ZERO do not light and product should not be placed in those pans.

4 - Programming COOK Times for 4-wide timer bar:

a) Stand directly in front of the PHU you desire to program. Simultaneously press the middle four buttons on the timebar and release them all (see Figure 3). The alphanumeric display for each pan will show its current COOK time in minutes (see Table 1). Notice that the leftmost light on the timer bar is FLASHING RED; this indicates you are programming PAN 1. Also the remaining lights will be illuminated to indicate the current COOK time as described in Section 7.

To modify the COOK time:

The 2nd from right button on the timer bar increases the COOK time by 5 minutes, or by 1 minute if the COOK time is less than 10 minutes, or 30 minutes if the COOK time is 240 minutes or greater.

The far right button on the timer bar decreases the COOK time by 5 minutes, or by 1 minute if the COOK time is 10 minutes or less, or 30 minutes if the COOK time is greater than 240 minutes.

b) To advance to the next pan, press the **far left button on the timer bar**. The next pan's light will be FLASHING RED.

c) To EXIT the COOK time programming mode, simultaneously press the middle four buttons on the timer bar and release them all. The NAME of each pan will appear in the alphanumeric displays. The lights of all pans with HOLD times greater than ZERO will be RED. The lights of pans with a HOLD time equal to ZERO will be off and product should not be placed in those pans.



Operating Instructions

5 - LINKING pans with like product types for 2 & 3-wide timer bar:

Linking pans allows the “Use First” indicators to display properly.

- a) **Simultaneously** press the 3 buttons on the right side of the 3-wide Pan Status timer bar (either top or bottom timer bar) see Figure 1 or 2. Notice the far left light illuminates RED. This indicates you are programming the PAN 1 links. The other lights indicate GREEN which pans are linked with PAN 1.
- b) To link a pan, press a key by an unlit indicator. The light will turn GREEN. To unlink a pan, press a key by a GREEN lit indicator and the light will go out.
- c) To advance to the next pan press the far left UP Arrow once. The other lights indicate in GREEN which pans are linked.
- d) To **EXIT** the link programming mode, simultaneously press the 3 far right buttons and release.

6 - Viewing PANS LINKED for 4-wide timer bar:

- a) Stand directly in front of the PHU you desire to view. Simultaneously press rightmost 2 pair of pan buttons (4 buttons) on the timer bar (skip the Transfer button) and release them all (see Figure 3). Notice that the far left light on the timer bar is RED and that all displays show product NAME. This indicates you are viewing PAN 1. Other lights indicate in GREEN which pans are linked with PAN 1.
- b) To advance to the next pan, press the far left button on the timer bar. The next pan's light will turn RED and the other lights indicate in GREEN which pans are linked.
- c) To EXIT link viewing, simultaneously press rightmost 2 pair of pan buttons (4 buttons) on the timer bar (skip the Transfer button), and release them all.

7 - Using Lights to Indicate Time:

In addition to the times shown in the alphanumeric displays, the colors of the lights for the pans not currently being programmed (i.e. the pans whose light is not FLASHING RED) also indicate the current time as follows.

- Each YELLOW light = 20 minutes.
- Each GREEN light = 5 minutes.
- Each FLASHING GREEN light = 30 minutes if time is over 120 minutes.
- Each RED light = 60 minutes.
- Each FLASHING YELLOW light = 120 minutes.

To determine the time setting, multiply:

- the number of YELLOW lights by 20
- the number of GREEN lights by 5
- the number of FLASHING GREEN lights by 30
- the number of RED lights by 60 (exclude the FLASHING RED light that indicates the current pan), and
- the number of FLASHING YELLOW lights by 120, and add the two numbers together.

For example, 2 YELLOW lights and 1 GREEN light indicate a time of 45 minutes.



“Your Solutions Partner”

Duke Manufacturing Co.
2305 N. Broadway • St. Louis, MO 63102
800.735.3853 • 3.231.1130 • 314.231.5074 Fax
www.dukemfg.com

Page 13 of 25

Operating Instructions

Figure No. 1
3-Wide Timer Bar

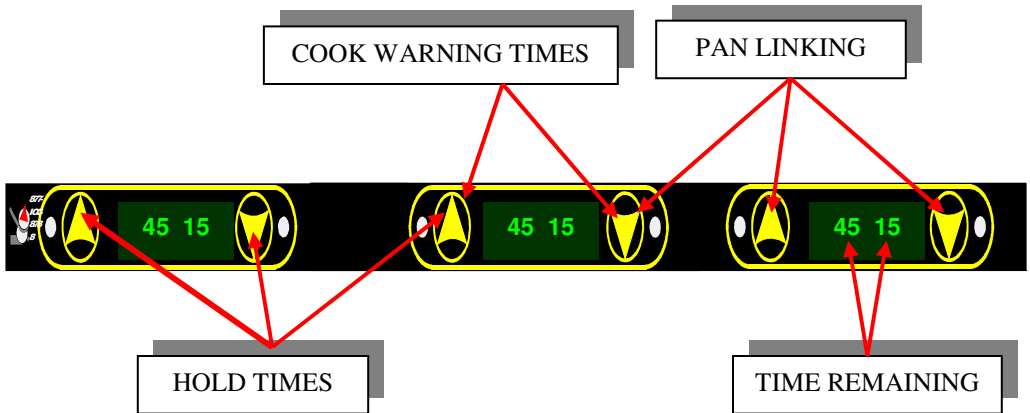

Figure No. 2
2-Wide Timer Bar

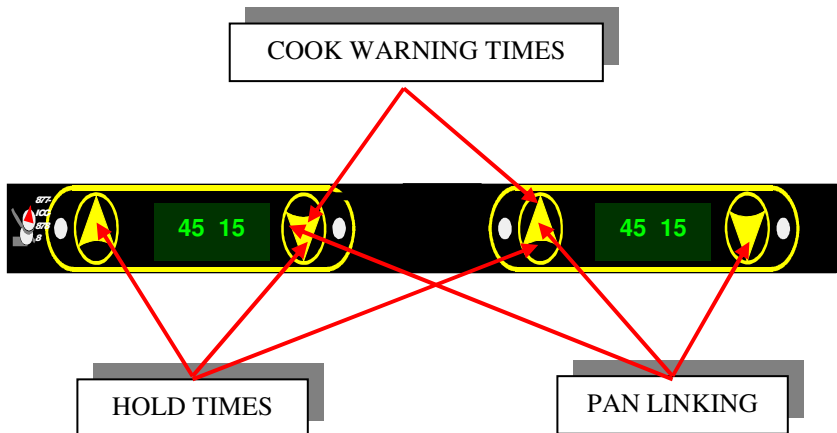
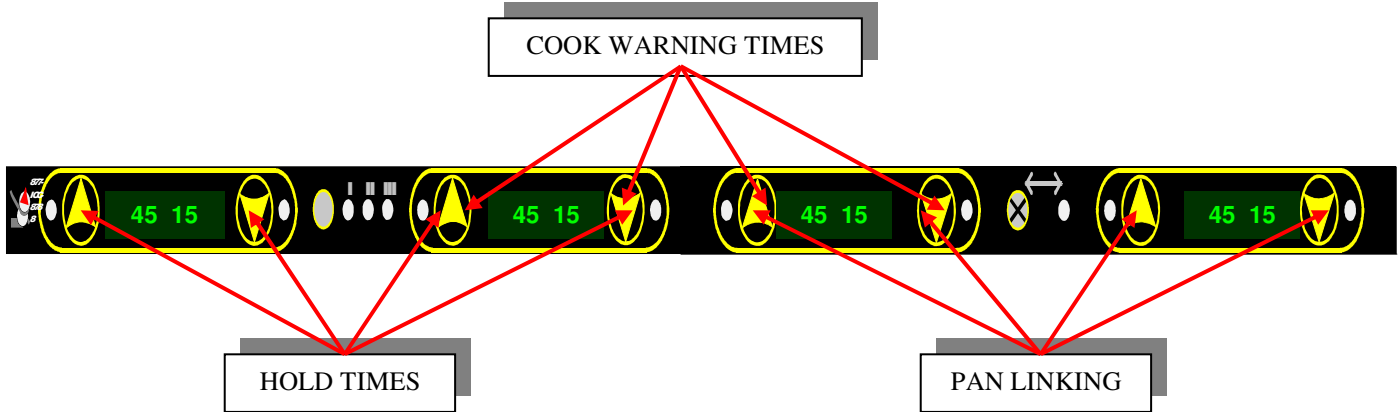

Figure No. 3
4-Wide Timer Bar



Operating Instructions

Table 1

KEYPRESS / MINUTES TABLE				
TIME	Palm Pilot® VALUE	EDITING MODE DISPLAY		NORMAL MODE DISPLAY
0	0	00	00	00
3 (COOK MODE ONLY)	3 (COOK MODE ONLY)	00	03	03
5	5	00	05	05
10	10	00	10	10
15	15	00	15	15
20	20	00	20	20
25	25	00	25	25
30	30	00	30	30
35	35	00	35	35
40	40	00	40	40
45	45	00	45	45
50	50	00	50	50
55	55	00	55	55
60	60	00	60	60
65	65	00	65	65
70	70	00	70	70
75	75	00	75	75
80	80	00	80	80
85	85	00	85	85
90	90	00	90	90
95	95	00	95	95
100	100	1h	40	1h
105	105	1h	45	1h
110	110	1h	50	1h
115	115	1h	55	1h
120	120	2h	00	2h
125	125	2h	05	2h
130	130	2h	10	2h
135	135	2h	15	2h
140	140	2h	20	2h
145	145	2h	25	2h

150	150	2h	30	2h
155	155	2h	35	2h
160	160	2h	40	2h
165	165	2h	45	2h
170	170	2h	50	2h
175	175	2h	55	2h
180	180	3h	00	3h
185	185	3h	05	3h
190	190	3h	10	3h
195	195	3h	15	3h
200	200	3h	20	3h
205	205	3h	25	3h
210	210	3h	30	3h
215	215	3h	35	3h
220	220	3h	40	3h
225	225	3h	45	3h
230	230	3h	50	3h
235	235	3h	55	3h
240	240	4h	00	4h
270	241	4h	30	4h
300	242	5h	00	5h
330	243	5h	30	5h
360	244	6h	00	6h
390	245	6h	30	6h
420	246	7h	00	7h
450	247	7h	30	7h
480	248	8h	00	8h
510	248	8h	30	8h
540	250	9h	00	9h
570	251	9h	30	9h



"Your Solutions Partner"

Programming With PDA

Programming Using the Palm Pilot® Personal Digital Assistant Option

A Palm Pilot® PDA may be used with the Hold Set-up software program and a special data cable.

The Hold Setup program is a very powerful tool and easy to use. In less than a minute, you can change the Product Name, HOLD and COOK WARNING times and then transfer the data into the Universal Control Board.

Products may be edited using cut and paste. HOLD and COOK WARNING times may be adjusted in 1-minute increments. The updated data is then sent to the Universal Control Board via the cable.

Multiple configurations can be stored, recalled and deleted by long file names. These records can also be beamed between Palm PDA's if your Palm models have the IR feature.

This option is the most time-efficient way to maintain the system configuration, especially for multiple restaurants.

EDIT FIELDS
FUNCTION SELECT

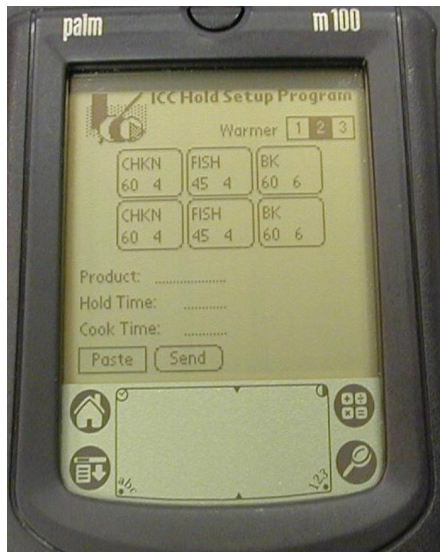

WARMER SELECT
PRODUCT SELECT

1 - Palm Hold Setup Program installation:

If a Palm PDA was shipped with your system, it will have the Hold Setup Program preloaded. If you have an existing Palm and a diskette was shipped with your system or you received an E-Mail with the program attached, please follow these installation instructions.

- a) Using Windows Explorer double-click on the file **ICC_Hold_Setup_Pgm.prc**
- b) A window will pop up prompting you to select a user. Select a user and click OK.
- c) A window will pop up informing you that the next time you perform a Hot-Sync, the ICC Hold Setup Program will be transferred to your Palm. Click Done.
- d) A window will pop up with a similar message. Click OK.
- e) Perform a Palm Hot-Sync as normal, and the Hold Setup Program will be transferred to your Palm PDA.



"Your Solutions Partner"

Duke Manufacturing Co.
2305 N. Broadway • St. Louis, MO 63102
800.735.3853 • 3.231.1130 • 314.231.5074 Fax
www.dukemfg.com

Page 16 of 25

Programming With PDA

2 - Palm PDA Programming:

- a) Execute the ICC Hold Setup Program on the Palm PDA. Observe the Main Screen with the “pans” displaying products, hold and cook warning times (see Figure 1). This represents the pans in a PHU referenced from the **front** of the PHU.

Fig.1 Main Screen – FWM34-43

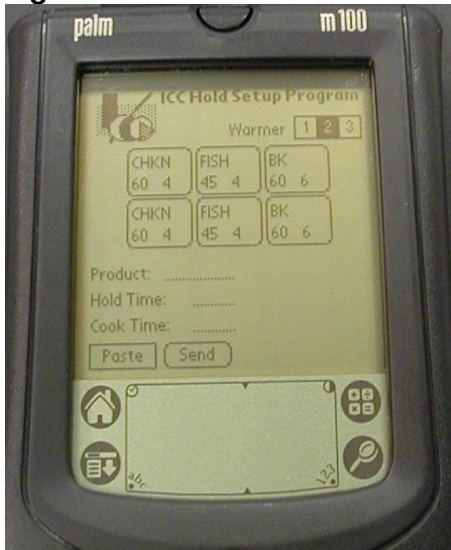
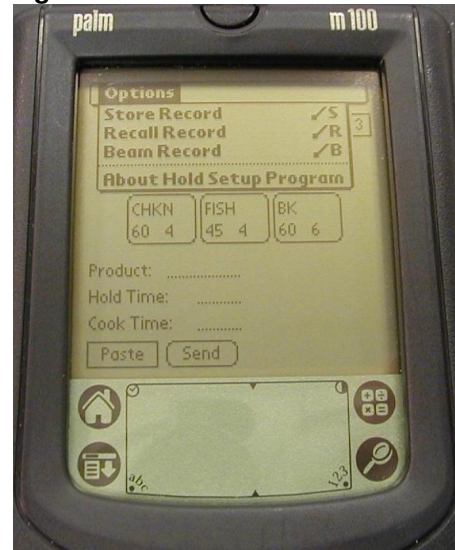

Fig. 2 Menu Pull-down – FWM34-43



- b) The PHU numbers are indicated on the top right portion of the screen and can be changed by touching 1,2 or 3 as desired. As you touch each PHU number, the Product Name, HOLD and COOK WARNING times change in the pans. Three PHUs can be connected together.
- c) To change the Product Name, HOLD time or COOK WARNING time, simply touch a pan and the data will be copied down to the editing fields. Change the data, touch PASTE, then touch the new pan location.
- d) To LINK pans, make the Product Name the same for the pans you want linked.



"Your Solutions Partner"

Duke Manufacturing Co.
2305 N. Broadway • St. Louis, MO 63102
800.735.3853 • 3.231.1130 • 314.231.5074 Fax
www.dukemfg.com

Programming With PDA

3 - Data transfer:

When the Send function is performed, the data for all 3 PHUs is transferred to the Universal Control Board.

- a) Attach the Hold Timer System cable to the Palm PDA and plug the 8-pin Telephone type cable into the port marked PROGRAM on the back side of the unit. Touch the Send button displayed in the Hold Setup screen. After a few seconds, "Send OK" will be displayed in the lower right portion of the screen.

Troubleshooting:

If an error message appears, check cable connection at the Palm and the Station Interface Unit.

Warning: When transferring data using the Palm M100 model, DO NOT press the Hot Sync button on the cable. The Universal Control Board may lock up and you will need to reset it by powering off and then back on.

4 - To Store, Recall and Delete records:

All of the timer data may be stored, recalled and deleted. These functions are very useful for saving different promotional menus.

- a) To Store a record touch the Menu icon to display the Menu Pull-down (see Fig.2). Touch Store Record. Enter a name for a new record or touch an existing record to overwrite. Touch Store to save the data **OR** touch Close to return to the Main screen without saving any data.
- b) To Recall a record, touch the Menu icon, then touch Recall Record. Touch an existing record to recall, then touch the Recall button **OR** touch Close to return to the Main screen without recalling any data.
- c) To Delete a record, touch the Menu icon, then touch Recall Record. Touch an existing record to delete, then touch Delete button **OR** touch Close to return to the Main screen without deleting any data.

Warning:

Once you touch Delete, the record will be deleted without any warning prompts.



"Your Solutions Partner"

Duke Manufacturing Co.
2305 N. Broadway • St. Louis, MO 63102
800.735.3853 • 3.231.1130 • 314.231.5074 Fax
www.dukemfg.com

Page 18 of 25

Cleaning and Maintenance



⚠ CAUTION ⚠

Electrical shock hazard. Do not wash with water jet or hose. Do not use caustic cleaners, acids, ammonia products, abrasive cleaners, or abrasive cloths. These can damage the stainless steel and plastic surfaces.

Periodic Maintenance, Checklist and Cleaning Guide

Daily

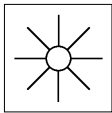

Opening Checklist

1. Ensure proper **Pan Covers** are inserted into the correct locations for fried and broiled products.
2. Place the **Power Switch**, located on the front of the Product Holding Unit, to the ON position.
3. Ensure both top and bottom **HEAT Lights** are illuminated.
4. Allow the Product Holding Unit to heat for at least 20 minutes, or until the **HEAT Lights** cycle off.

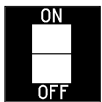

Operation Instructions/Adjustments

1. If the **SERVICE Light** illuminates during operation of the Product Holding Unit, discontinue use of the affected shelf until the module is serviced.
2. Operate using the timer bar as outlined in the Operating Instructions.



Closing Checklist

1. Turn power switch OFF.
2. Remove all pans and pan covers.
3. Allow to cool for approximately 30 minutes.
4. Clean Product Holding Unit as outline in the Daily Cleaning Instructions.

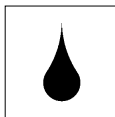

Cleaning Instructions

1. Wipe down the interior and exterior of the Product Holding Unit with warm water and mild detergent using a soft cloth. Do not use excessive amounts of water.
2. Clean pans and pan covers using mild detergent and warm water. Ensure all soap is rinsed from plastic pans and pan covers.



"Your Solutions Partner"

Duke Manufacturing Co.
2305 N. Broadway • St. Louis, MO 63102
800.735.3853 • 3.231.1130 • 314.231.5074 Fax
www.dukemfg.com

Page 19 of 25

Troubleshooting

There are no user serviceable parts on the Duke Product Holding Cabinet. If a malfunction occurs, ensure unit is plugged in then check all switches and circuit breakers. If the malfunction still exists, contact your Duke Manufacturing Company authorized service agent or call 1-800-735-3853.

Electronic Control Fault Indications

The Service Light is located on the front of the control next to the heat light (see Figure 3). It provides an indication to alert the operator to failures in the heater circuit. When a Service Light is on, the affected shelf should not be used until the cause of the fault is corrected by a qualified service technician. The fault conditions that could cause the control to turn the service light on are as follows:

1. **Over-Temperature Fault** - An over-temperature fault occurs when the control senses that the shelf temperature is higher than the specified factory preset temperature. This occurs when the power is not removed from the heating element after the shelf has achieved the preset temperature, causing the control to turn on the service light. The auxiliary thermostat prevents the temperature from exceeding safe levels by regulating the temperature to a maximum of 250 °F.

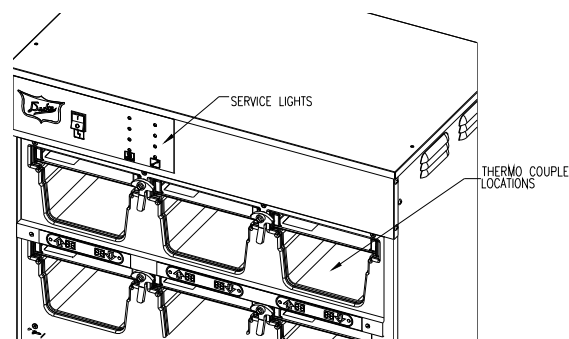

Figure 3

2. **Under-Temperature Fault** - An under-temperature fault occurs when the control senses that the shelf temperature is lower than the specified factory preset temperature for more than 30 minutes continuously. This occurs when heating element circuit opens or the RTD Feedback signal is faulty, causing the control to turn on the service light.

Temperature Check Procedure

1. A digital temperature meter that has been calibrated must be used to get an accurate temperature reading. Use a thermocouple surface temperature probe to measure temperatures.
2. No pans should be in wells during the pre-heat and temperature check. Pre-heat the PHU for 30 minutes before taking any temperature readings. Do not take readings unless the cavity has been empty for 30 minutes. This will allow the temperature to stabilize and will prevent false readings.
3. The PHU cavity should be cleaned and empty before the temperature is checked. Avoid any air drafts that might flow through the cavity.
4. Locate the surface temperature probe on the bottom of the first cavity in the geometric center. The first cavity is the one closest to the control panel (see Figure 3). Make sure the probe is making good contact with the surface while taking readings.
5. All temperature controls exhibit a swing in temperature as the control cycles on and off while regulating to the set point. The correct calibration temperature is the average of several readings taken over a period of 20 minutes after the PHU has been pre-heated. The average temperature should be $\pm 5^{\circ}\text{F}$ from the set point.



"Your Solutions Partner"

Duke Manufacturing Co.
2305 N. Broadway • St. Louis, MO 63102
800.735.3853 • 3.231.1130 • 314.231.5074 Fax
www.dukemfg.com

Page 20 of 25

Troubleshooting

Pan Status Timer Bar Test:

- a. Press a pan button once. The corresponding light turns green. Press the same button again. The corresponding light turns red. Repeat for every button on all timer bars.

Troubleshooting:

1. If the light turns red, and then turns off, the HOLD time is equal to 0. Program a new duration for at least one of the PHASEs for that pan.
2. If the timer bar test fails, plug the timer bar into a different PHU jack on the Station Unit and repeat the test on that timer bar. If the timer bar continues to fail the test, the timer bar is suspect. If the timer bar passes the test when plugged into a different PHU jack, the Universal Control Board is suspect.

Universal Control Board Power Test:

- a. Power up the PHU unit.
- b. Observe that the timer bar lights illuminate yellow, then red or go out depending on the programmed hold times.

Troubleshooting:

1. Check that the PHU control powers up and the PHU heats up. If not, call Duke Mfg. for PHU service at 314-231-1130 or 800-735-3853.

Service Hot-Line:

If you believe that you have a service issue, perform the steps outlined above. If a test fails, perform the troubleshooting steps to see if this resolves the problem. Continue the remainder of the testing, if possible, to uncover any additional problems and document the symptoms and results.

Please have this data handy before calling the Duke troubleshooting Hot Line listed above.

For optimum support, please be near the suspect units with a cordless phone, if available, when calling our Technicians.



"Your Solutions Partner"

Duke Manufacturing Co.
2305 N. Broadway • St. Louis, MO 63102
800.735.3853 • 3.231.1130 • 314.231.5074 Fax
www.dukemfg.com

Page 21 of 25

Parts List And Illustrations

Locator	P/N	Description	Quantity per Unit				
			FWM34-22	FWM34-23	FWM34-24	FWM34-42	FWM34-43
1	159142	Cord, Power, 30 AMP, 250V,for 208-240V units					1
	159243	Cord, Power, 20 AMP, 250V,for 208-240V units				1	
	159211	Cord, Power, 15 AMP, 125V,for 120V units				1	
2	156316	Transformer, 120Vprimary,12Vsecondary	1	1	1	1	
	155749	Transformer, 208V/240Vprimary,12Vsecondary	1	1	1	1	1
	156838	Transformer, 230Vprimary,12Vsecondary	1	1	1	1	1
3	157490	Faceplate with Gasket Assy 2X2	2				
	157410	Faceplate with Gasket Assy 2X3		2			
	157424	Faceplate with Gasket Assy 2X4			2		
	157739	Faceplate with Gasket Assy 4X2				2	
	157738	Faceplate with Gasket Assy 4X3					2
4	156499*	Cable, Programming, with RJ12 plug, 6 pin*	3	3	3		
	156666*	Cable, Programming, with RJ12 plug, 6 pin*				1	2
5	156498*	Cable, Programming, with RJ45 plug, 8 pin*	1	1	1	1	1
6	157428	Heating Element, 120V, 2 Wide, Deep well	4			8	
	157418	Heating Element, 120V, 3 Wide, Deep well		6			
	157816	Heating Element, 120V, 4 Wide, Deep well			8		
	157748	Heating Element, 208V, 2 Wide, Deep well	4			8	
	157736	Heating Element, 208V, 3 Wide, Deep well		6			12
	157817	Heating Element, 208V, 4 Wide, Deep well			8		
	157749	Heating Element, 230V, 2 Wide, Deep well	4			8	
	157737	Heating Element, 230V, 3 Wide, Deep well		6			12
7	156938	Terminal Block, 5 Position	1	1	1		
	157743	Terminal Block, 8 Position				1	1
8	155750	RTD, 1000 Ohms, Temperature Sensor,24"	2	2	2		
	157725	RTD, 1000 Ohms, Temperature Sensor,54"				4	4
9	157768	Universal Controller Board Assembly				1	1
10	600106	Temperature Control	1	1	1		
	157742	Temperature Control				2	2
11	157758	LED Board				1	1
12	156527	Switch,Lighted,DPST,On-Off, 16 AMP,250VAC	1	1	1	1	
	159084	Switch,Lighted,DPST,On-Off, 20 AMP,250VAC					1
13	155753	Thermostat, Hi-Limit	2	2	2	4	4
14	156677	Timer Bar 2-Wide	2				
	157550	Timer Bar 2-Wide, Pair				2	
	156676	Timer Bar 3-Wide		2			4
	157539	Timer Bar 4-Wide			2		
15	157726	Cable Assembly – LED Board				1	1
16	157413	Label – Control	1	1	1		
	157701	Label – Control				1	1
17	157717	Extrusion – Heat Sink 4"D black	4	6	8	8	12
18	156310	Panel, Access top, 2 Wide	1				
	156298	Panel, Access top, 3 Wide		1			
	154884	Panel, Access top, 4 Wide			1		
	157716	Panel, Access top, 2 Wide				1	
	157715	Panel, Access top, 3 Wide					1
19	157405	Panel, Access left/Right	2	2	2		
	157722	Panel, Access left/Right				2	2
20	157744*	Food Pan with Notch (no handle)	AR	AR	AR	AR	AR
	157756*	Food Pan with Handle					
21	155876*	Lid (Black) without vent holes	AR	AR	AR	AR	AR
	155873*	Lid (Gray) with vent holes					
22	156285	Latch, Lid Stop	4	8	8	8	16
23	156288	Screw, Shoulder	4	8	8	8	16
24	156059	Connector, Modified, Front / Rear	1	1	1	1	2

*Note: Not shown



Parts List And Illustrations

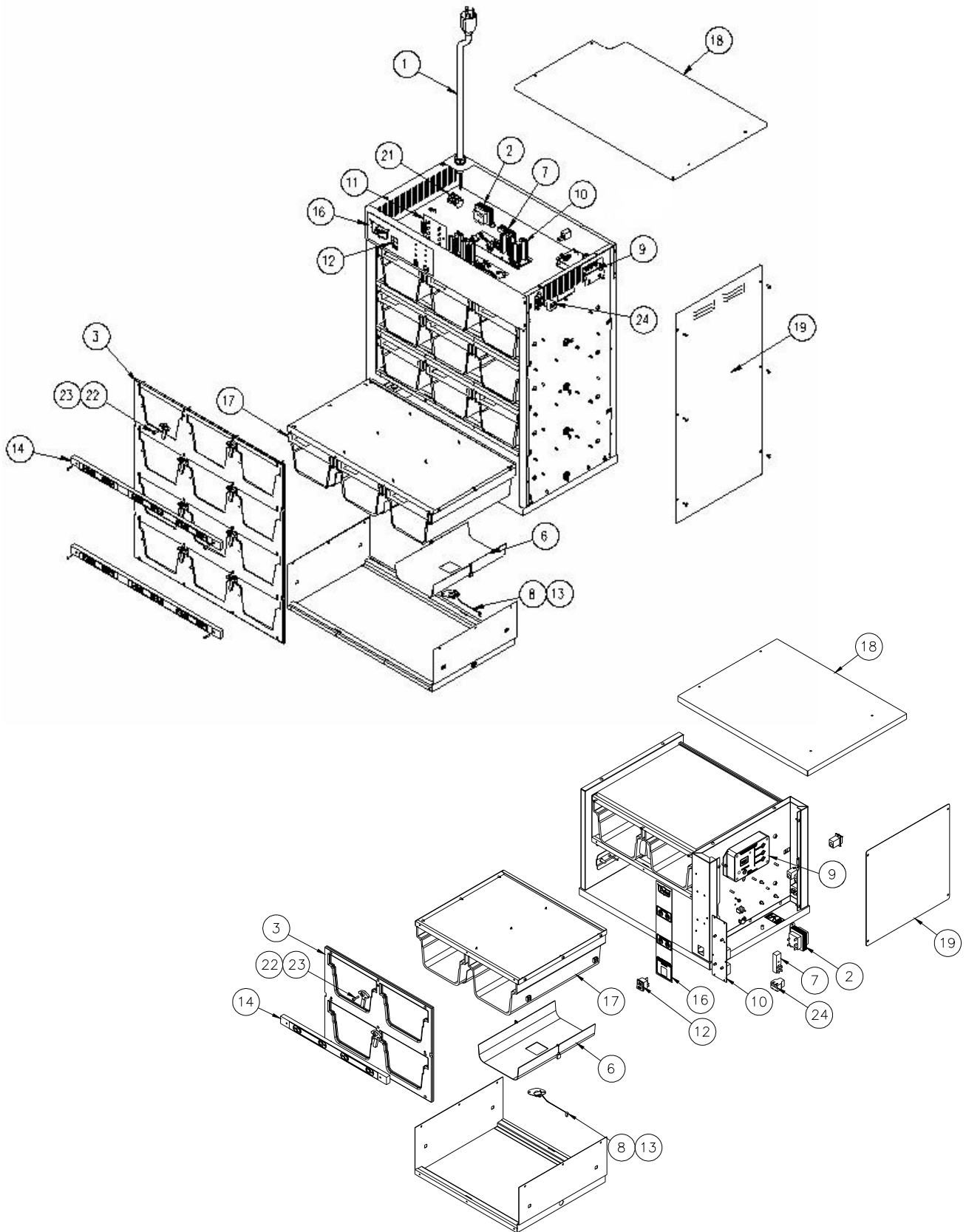

Wiring Diagram

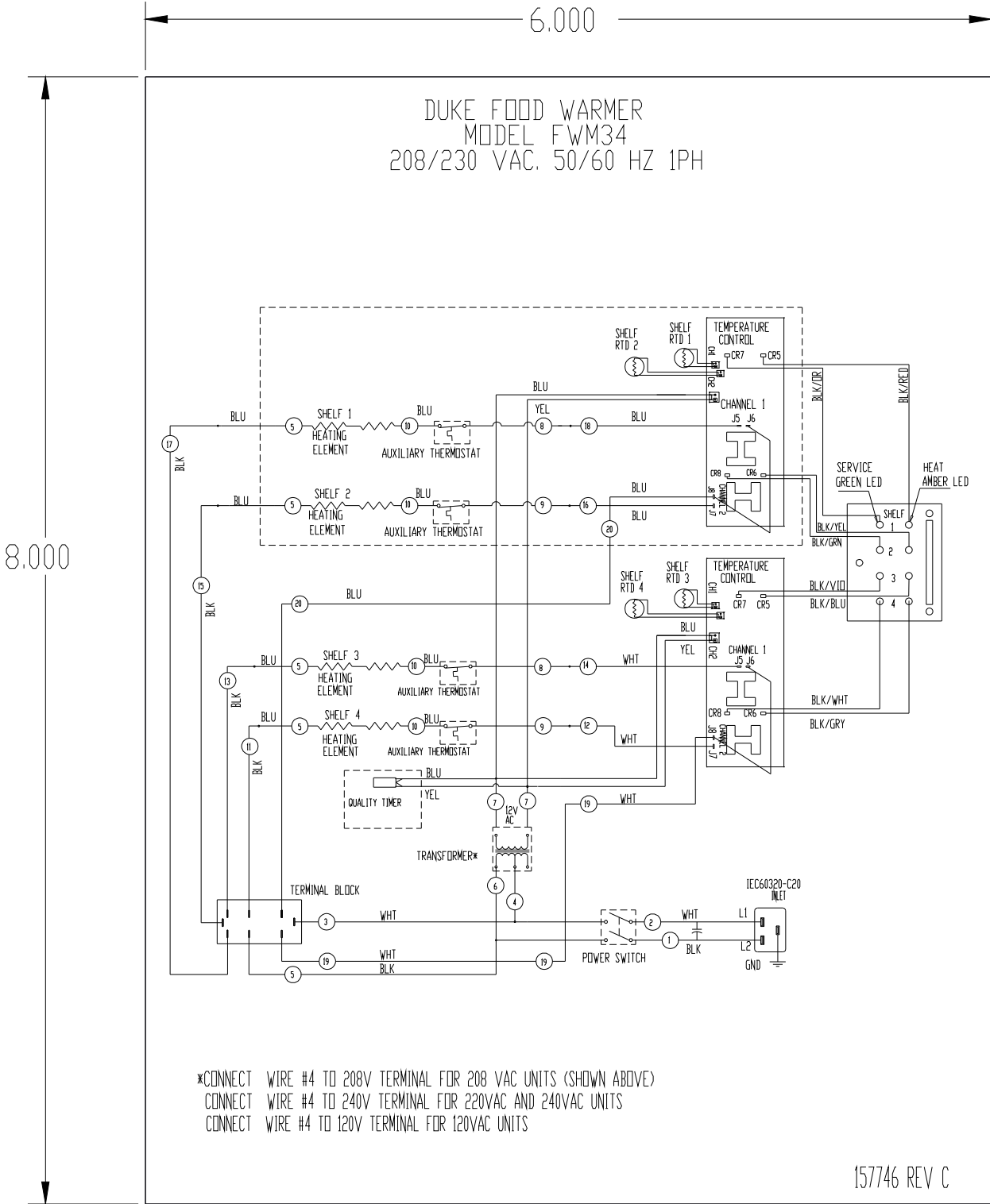

For Customer Assistance

To aid in reporting this unit in case of loss or theft, please record below the model number and serial number located on the unit. We also suggest you record all the information listed and retain for future reference.

MODEL NUMBER _____	SERIAL NUMBER _____
DATE OF PURCHASE _____	
DEALER _____	TELEPHONE _____
SERVICER _____	TELEPHONE _____

TO PHONE:

Dial 1-800-735-DUKE (3853)

**SERVICE
PARTS
ADDITIONAL CUSTOMER INFORMATION**

TO WRITE:

**Duke Manufacturing Co.
2305 N. Broadway
St. Louis, MO 63102**

TO ACCESS INTERNET: www.dukemfg.com

Please provide the following information when you write or call: model number, serial number, date of purchase, your complete mailing address (including zip code), and description of the problem