

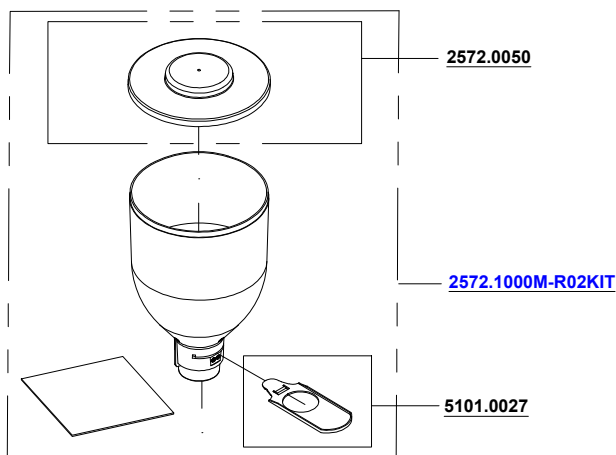

HELIOS 80

220V/60Hz
220-230V/50Hz
230-240V/50Hz

03/08/2023



2572.0100KIT-6060
FISSAGGIO MACINE E
PORTAMACINE
BURRS AND BURRS HOLDER
FASTENING SCREWS

(6060.0002) ⚙️ ⚙️ ⚙️

(6060.0032) ⚙️ ⚙️ ⚙️

(6060.0177) ⚙️ ⚙️ ⚙️

2572.0200KIT-6060
GRUPPO VITI PANNELLO DI
CONTROLLO
PANEL CONTROL GROUP
SCREWS

(6060.0176) ⚙️ ⚙️

(6060.0030) ⚙️

(6061.0010) ⚙️ ⚙️

(6060.0036) ⚙️ ⚙️

(6060.0022) ⚙️

(6061.0002) ⚙️

2572.0107M-R05KIT

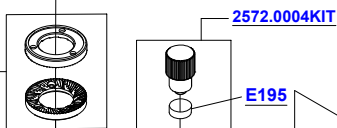
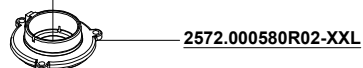
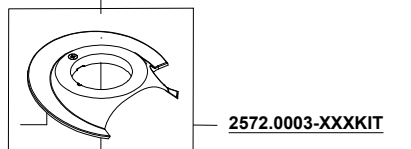
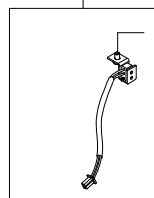

MAC78ITA CP

2572.0028-XXX

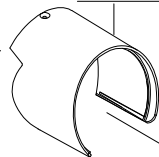

E188

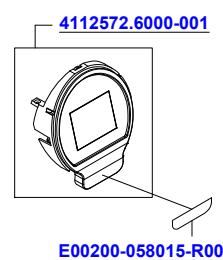
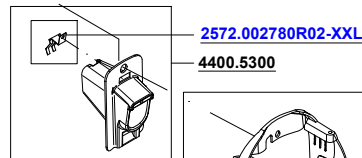
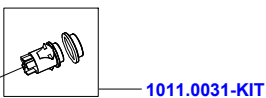
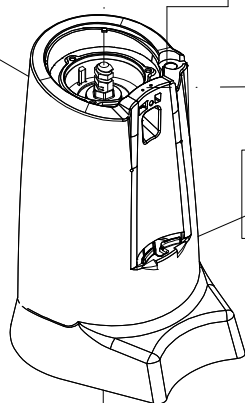

2572.0021G-KIT

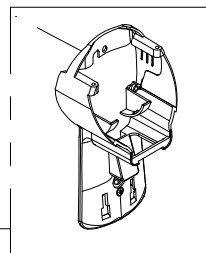

E00200-058015-R00

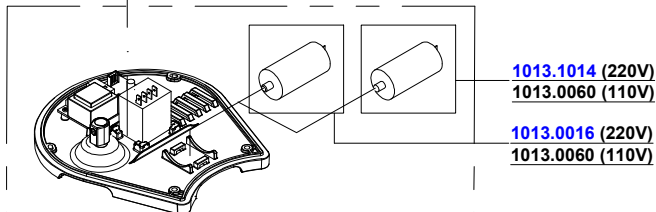

4112572.5000

2572.0100

4112572.3000

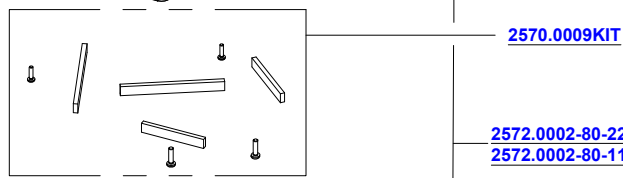

CAV2572-80-KIT
CAVI ALIMENTAZIONE
POWER SOURCE CABLES

(CAV71) (CAV10UL) (6040.0033)

(CAV61) (CAV88) (CAV94) (CAV95) (CAV65-ATOM)

1005.0240F13A G.B.-U.K.
1005.1250 COREA-KOREA
1005.0220 SCHUKO 2mt.
1005.4220 SVIZZERA-SWITZERLAND
1005.1240 AUSTRALIA
1005.6220 CINA-CHINA
1005.0112 USA

N.B. : DOVE INDICATO CON "XXX" SI RICHIEDE DI SPECIFICARE IL COLORE
PLEASE NOTE : WHERE "XXX" IS INDICATED YOU HAVE TO SPECIFY THE COLOUR



YOUR COFFEE
EXPERIENCE

Listino ricambi/ Spare Parts Price List HELIOS 80

ARTICOLO ITEM N°	DESCRIZIONE DESCRIPTION
1005.0112	CABLAGGIO UL/CSA V110 2m USA/CANADA PLUG V110
1005.0220	CABLAGGIO MONOFASE spina schuko SCHUKO PLUG 2 mt V220
1005.1240	CABLAGGIO VOLT. 240 per Australia AUSTRALIA PLUG V230-240
1005.1250	CABLAGGIO VOLT. 220 per Korea KOREA PLUG V220
1005.4220	CABLAGGIO MONOFASE per Svizzera SWITZERLAND PLUG V220-230
1005.6220	CABLAGGIO MONOFASE per Cina CHINA PLUG V220-230
1013.0016	CONDENSATORE MF.16 UL CAPACITOR MF. 16 220V
1013.0060	CONDENSATORE MF.60 UL PER MYTHOS CAPACITOR 60 μ F
1013.1014	CONDENSATORE 14MF 440Vac 50/60Hz CAPACITOR MF. 14 220V
2572.0050	COPERCHIO CAMPANA HELIOS BEAN HOPPER COVER
2572.0100	KIT MICRO ATTIV. HELIOS MICRO-SWITCH KIT
4400.5300	KIT THUNDER ON DEMAND HELIOS ON-DEMAND THUNDER KIT
5101.0027	LINGUETTA CAMPANA HELIOS HOPPER TAB
4112572.3000	GR.SCIVOLO CAFFE' HELIOS 80 COFFEE EXIT SLIDE GROUP
4112572.5000	GR. BLOCCO FORCELLA HELIOS 80 FORK GROUP



YOUR COFFEE
EXPERIENCE

Listino ricambi/ Spare Parts Price List HELIOS 80

1005.0240F13A	CABLAGGIO VOLT. 240 per GB + fus. 13A UK PLUG WITH 13A FUSE
1011.0031-KIT	INTERRUTTORE NERO STABILE x HE KIT POWER SWITCH FOR HELIOS KIT
2570.0009KIT	KIT PIEDE BASE ZENITH - RICAMBIO BASE FEET KIT
2572.0002-80-110KIT	KIT BASE HELIOS 80 110V BASE GROUP 110v
2572.0002-80-220KIT	KIT BASE HELIOS 80 220V BASE GROUP 220v
2572.0003-001KIT	KIT CORALLINA HELIOS NERO TOP COVER KIT HELIOS
2572.0004KIT	KIT POMELLO HELIOS KNOB KIT
2572.000580R02-XXL	PORTAMACINE SUP. 80 HELIOS AG/05*** UPPER BURR HOLDER
2572.0021G-KIT	KIT FRONTALE HELIOS FRONTAL PANEL KIT
2572.002780R02-XXL	FLAP x HELIOS 80 FLAP KIT
2572.0028-001	TETTOIA HELIOS 001 NERO OPACO CONTROL PANEL COVER
2572.0100KIT-6060	KIT VITI HELIOS PORTAMACINE BURRS FASTENING SCREWS
2572.0107M-R05KIT	KIT MICRO CAMPANA HELIOS RIC. HOPPER MICROSWITCH CABLE
2572.0200KIT-6060	KIT VITI HELIOS GR.FRONTALE CONTROL PANEL SCREWS GROUP
2572.1000M-R02KIT	KIT RICAMBIO CAMPANA HELIOS BEAN HOPPER
4112572.6000-001	GR. PANN.COM. HELIOS 65 / 80 ELECTR. DOSER CTRL PANEL
CAV2572-80-KIT	KIT CAVI HELIOS 80 POWER SOURCE CABLES KIT



YOUR COFFEE
EXPERIENCE

Listino ricambi/ Spare Parts Price List HELIOS 80

E00200-058015-R00	ETICHETTA HELIOS 80 NERA HELIOS 80 LABEL (BLACK)
E188	ETICHETTA SCUDETTO "EUREKA 1920" R/W EUREKA 1920 ATOM LABEL
E195	ETICH.POMELLO HELIOS KNOB REGULATION LABEL
MAC78ITA CP	COPPIA MACINE 78mm HELIOS HARDENED STEEL FLAT BURRS SET mm80

- Gli articoli evidenziati sono i ricambi delle parti soggette a maggiore usura, e quindi il loro approvvigionamento è particolarmente consigliato
- Tutti i prezzi si intendono IVA esclusa
- La merce viene venduta franco fabbrica a Sesto Fiorentino (FI) e viaggia a rischio del committente.

- The items highlighted are the spare parts of the pieces subject to greater wear, and therefore their supply is particularly recommended
- All prices are intended VAT excluded
- Goods are sold ex works from Sesto Fiorentino (FI), Italy and travel at the risk of the Customer