



**Combi-Steamer
GENIUS Compact**



**Combi-Steamer
Joker T**

Operation Manual



Dear customer,

You have chosen an Eloma combi-steamer.
Thank you for your confidence.

This operation manual is for the combi steamer model Genius compact and Joker T.

Please read the installation and operating instructions in full before starting up the appliance and make sure to pay particular attention to the safety information.
They contain important information on correct installation and operation.

This unit may only be used for preparing food in commercial kitchens. Every other usage is against definition and therefore dangerous.

For information and tips please contact:

Eloma GmbH . Innovative Koch- & Backtechnik
82216 Maisach / Germany Otto-Hahn-Str. 10. Tel.: +49 (0) 8141 395-0 Fax: +49 (0) 8141 395-130

For our cooking forum and user tips, visit our website at www.eloma.com.
User hotline: +49 (0) 180 / 5 22 42 71

Service

You can reach us practically around the clock, 7 days a week, 365 days a year:
Your service hotline: +49 (0) 180 / 52 24 27 2

For information on liability for material defects and warranty conditions, please consult our general terms and conditions of business (T&C).

 Eloma GmbH D-82216 Maisach	
Appliance model:.....	
Appliance Nr.:.....	
Dealer:	Installer:
Date:.....	Installed on:.....

Operation Manual

Combi-Steamer Genius compact and Joker T 6-23

Table of contents:

<ul style="list-style-type: none"> 1. Safety information 4 2. Control panel and functional description.... 7 <ul style="list-style-type: none"> 2.1 Control panel Joker T, Genius compact 7 2.2 Operation with Joker Scout 8 2.3 Manual operation..... 8 3. Start-up in manual operation..... 9 <ul style="list-style-type: none"> 3.1 Manual input..... 9 3.2 Manual operation – Input of one step 10 3.3 Manual operation – Input of two steps..... 11 3.4 Manual operation – Input of several steps. 12 3.5 Display of the actual situation 12 3.6 Display of actual values..... 13 3.7 Additional functions 14 3.8 Delay start programming – Manual input... 14 4. Cooking procedures..... 15 5. Program Storage..... 16 <ul style="list-style-type: none"> 5.1 Save Programs..... 16 5.2 Delete a Program 19 5.3 Copy a Program 19 5.4 Select and start a Program from the Program List..... 20 5.5 Select and start a Program from the Favourite List..... 20 5.6 Delayed start in program operation 21 6. Menu groups in fully automatic operation 22 <ul style="list-style-type: none"> 6.1 Select and start a program via menu group..... 22 6.2 Picto operation 22 7. Special Programs..... 23 <ul style="list-style-type: none"> 7.1 Regenerating..... 23 7.2 LT-Cooking (Low temperature)..... 24 7.3 Cook & Hold 25 7.4 Delta-T- Cooking 26 7.5 Baking 27 	<ul style="list-style-type: none"> 8. Combi cooking 28 9. Preheat – Cool Down Active Temp..... 29 10. HACCP 30 <ul style="list-style-type: none"> 10.1 Serial Interface – Connecting cable 30 10.2 Selection and printing of recorded cooking processes 31 11. Special programs..... 32 <ul style="list-style-type: none"> 11.1 Weekly program 32 11.2 Setup..... 32 <ul style="list-style-type: none"> 11.2.1 Time/Date..... 32 11.2.2 Start Sreen 33 11.2.3 Language 33 11.2.4 Unit parameters 33 12. Cleaning the cooking chamber 34 <ul style="list-style-type: none"> 12.1 Automatic self cleaning Autoclean 34 12.2 Delay start of autoclean..... 35 12.3 Selection and printing of recorded autoclean protocols 35 12.4 Manual Cleaning 35 13. Hints on operational safety 36 14. Communication ProConnect ↔ Combi steamer 37 <ul style="list-style-type: none"> 14.1 Start up communication ProConnect ↔ Combi steamer..... 37 14.2. Connection to Kitchen control systems 37 15. Error..... 38 <ul style="list-style-type: none"> 15.1 Error display 38 15.2 Error Message..... 39 15.3 Trouble Shooting..... 40 15.4 Turn off the combi steamer 40 16. Cleaning and maintenance 41 17. EC Declaration of Conformity 42
---	--

Version 1.3
Article No. 501283 5/2011

Pictograms/symbols used



Danger!

Indicates a situation presenting an immediate danger, which, if not avoided, will result in serious injury or death.



Warning!

Indicates a potentially dangerous situation, which, if not avoided, could result in serious injury.



Caution

Indicates a potentially dangerous situation, which, if not avoided, could result in minor or moderate injury.



Caustic substances



Caution: Risk of burns



Caution: Hot steam



Caution: Hot liquid



Risk of fire



Warning: Dangerous electrical voltage



1. Safety information

- Installing the appliance incorrectly, making incorrect settings on it or modifying it can lead to damage, injury or even death.
- Read the installation and operating instructions for the combi steamer through carefully before starting it up.

Use for intended purpose

- The appliance shall only be used for its intended purpose, namely the professional preparation of food.
- Eloma combi steamers are designed for use in commercial environments.

Method of operation

- The combi-steamer *Genius compact, Joker T* offers every possibility to experience modern professional cooking technology. Use fresh or convenience products and select for every product the best possible cooking cabinet climate.
- With just a light touch you direct the operating rocker *Joker* any way you like to determine cooking temperature and humidity levels for any type of food in up to 20 cooking steps, a feature we call *Stepronic*®.
- Temperatures and humidity levels are displayed in the movable *Climatic*® cursor. Every movement of the *Climatic*® Cursor generates a change of the cooking parameters, temperature and humidity, one after the other or simultaneously. The interactive monitor displays all those important points.
- This simple and quick settings facilitate your daily work, leaving you more time for whatever you like. The settings are automatically monitored guaranteeing perfect cooking results. No need to control constantly temperature and humidity levels.
- **Temperature** settings range from **30 to 300°C** and the **chamber humidity** levels from **0° to 100%**.
- Many functions offer optimum utilisation for steaming, poaching, baking, roasting, grilling, stewing, blanching, thawing, preserving, regenerating and a lot more.
-
- The *Genius compact, Joker T* will certainly become your reliable partner. Extremely easy to operate, offering unlimited possibilities.

Operation

- Keep this manual in a place where it can be accessed by all users of the appliance at any time.

The combi steamer must only be operated

- By trained staff
- For its intended purpose as outlined in the operating instructions, and whilst in perfect working order.
- To prevent the risk of accidents or damage to the appliance, it is essential that operating staff are given training and health and safety briefings on a regular basis.
- If the machine is set up outside, it must be ensured that it is adequately protected from rain, thunder storms and lightening. It must be set up on a solid foundation to ensure stability. It must also be ensured that the machine is only accessible for qualified personnel.

The appliance must not be operated

- By children or persons with impaired physical, sensory or mental abilities, or by persons who do not have the requisite experience and/or knowledge, unless they are being supervised by a person who is responsible for their safety or are receiving instructions in how to use the appliance from this person
- At an ambient temperature of < +4°C
- In toxic atmospheres or atmospheres where there is a risk of explosion
- With food containing highly flammable ingredients (e.g. alcohol)



- Only authorised customer service personnel may open the side wall and carry out repairs and maintenance work.



Risk of injury Installation

- Please refer to the installation instructions for precise information on how to install the appliance.
- Only authorised customer service personnel may install appliances, put them into operation and perform maintenance work on them.
- When using deep fat fryers or portable stoves next to the appliance, make sure that they are kept at a suitably safe distance from it (based on the radius of action of the shower head). There is a serious risk of the operator sustaining burns if water is sprayed into hot fat.



Risk of burns!

- The functional surfaces of the appliance become hot during operation.



Risk of burns!

- Care must be taken when opening the cooking chamber door, as hot air and steam could escape.



Caution! Hot liquid in container

- If containers are filled with liquids or contents that will become liquid during cooking, ensure that they are inserted at a level which will enable the user to see into them (i.e. the containers must not be placed too high up in the appliance).



Appliance defects

- If the glass part of the door is damaged, the appliance must not be started up. Contact customer service.
- If malfunctions occur, disconnect the appliance from the mains and close the water shut-off valve. Contact customer service.



Hand shower

- Water runs only when the oven is switched on
- The appliance is equipped with a hand shower
- How to work the shower:
 - Pull it out.
 - Hold the hose with one hand and press the push button with the other hand whilst cleaning.
- How to roll the shower back:
 - Let it roll up slowly, it winds up automatically



Cleaning

- In operation and during cleaning there is a risk of burns at the rear drain area.
- The shower head may only be used for cleaning the cooking chamber.
- Do not spray water into the hot cooking chamber.
- Under no circumstances must water jets, steam cleaners or high-pressure cleaners be used on the exterior of the appliance.
- The door must not be opened whilst Autoclean is running (risk of chemical burns).
- Only use Eloma Multi-Clean special cleaning agents and Eloma Multi-Clean rinse agents.
- Eloma GmbH accepts no liability for damage caused by using non-Eloma cleaning agents or rinse agents; use of such agents will also invalidate any warranty claims.



- Please observe the instructions for use provided with the cleaning agent and rinse agent.
- Wear appropriate protective gear when carrying out manual cleaning work (gloves, protective goggles).
- Do not breathe in spray mist.
- Make sure that the air baffle and racks are used and locked in place in accordance with regulations.
- When using the Autoclean function, make sure the canisters are connected correctly: red for the cleaning agent and blue for the rinse agent.
- Before cleaning, make sure that there is sufficient cleaning and rinse agent in the respective canisters.
- Canisters must be positioned below the bottom edge of the combi steamer. They must never be positioned above this.



Notes on maintenance

- To keep the appliance in perfect working order, an authorised service partner should carry out maintenance work on it at least once a year.
- We recommend that you agree a maintenance contract for this purpose.
- If the appliance is not going to be used for a prolonged period, turn it off, disconnect it from the mains and close the water tap.

Before turning on

- Before closing the oven door make sure that the pans and grids inside are securely in place to avoid damages to the door glass.
- When opening and closing the door take care to leave enough space for yourself and other people to avoid possible injuries.
- Lock the air baffle in place. Never reach behind the air baffle during operation and never attempt to stop fans manually.
- Lock the rack in place correctly.

Loading/unloading



Risk of burns

- Depending on the selected cooking temperature, the food containers, grids and inside of the door in particular may reach high temperatures. It is recommended that you wear protective gloves.
- The temperature of the glass part of the door and the casing may reach more than 60°C at some points during operation.
- Containers with hot liquid foodstuffs must be covered during transportation to prevent the liquid from spilling over the sides.
- Maximum permissible loading weight:
- Loading capacity 15 kg

Fixing the rack in place (tabletop appliances)

- Hanging in place: Push the rack up and hang it in place.
- Take care not to bend the tracks when doing this, as this will stop grids, trays and containers from being held securely in place.



Working with core temperature sensors

- Core temperature sensors can become hot! Wear protective gloves.
- Take care not to prick yourself or anyone else with the point of the sensor.
- Before piercing, check the sensor for soiling to prevent cross-contamination between products.
- Do not leave the sensor hanging out of the cooking chamber. It is a sensitive measuring instrument, so always hang it up in the place provided for it.
- Remove the sensor from the food before taking the batch out.

Condensation hood (option)

- An optional condensation hood is available for Eloma combi steamers.
- The condensation hood is controlled fully automatically via the combi steamer.
- During the cooking process, steam is condensed as it passes over air-cooled plate condensers.

2. Control panel and functional description

2.1 Control panel Genius compact, Joker T

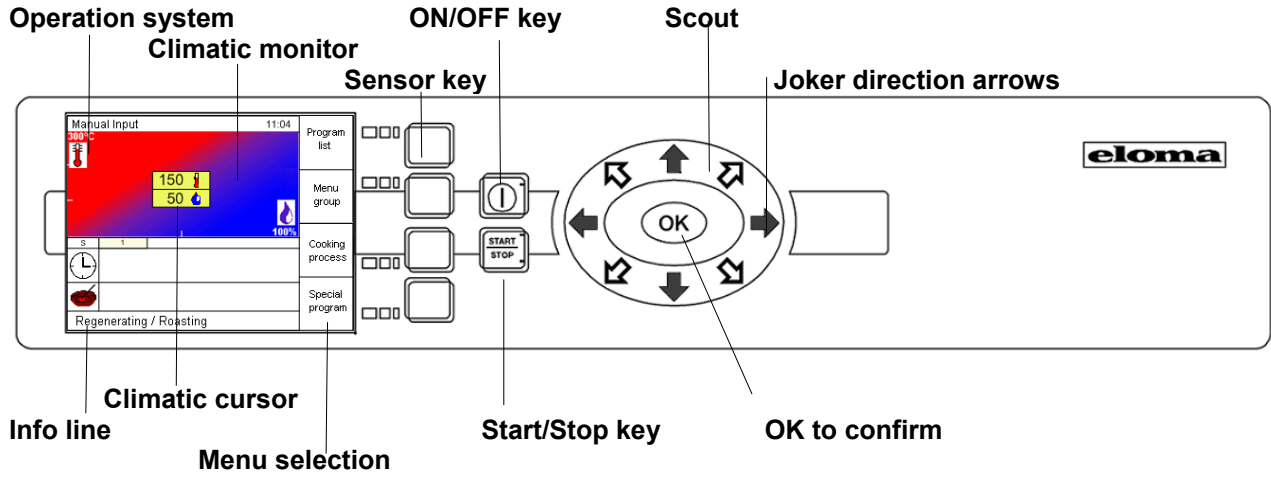

2.2 Operation with Scout

Use the Joker Scout direction arrows to move the Climatic cursor on the Climatic monitor, to reach other input fields and to set data, characters etc. Whenever a field is yellow, it is ready for inputs.

Direction arrows

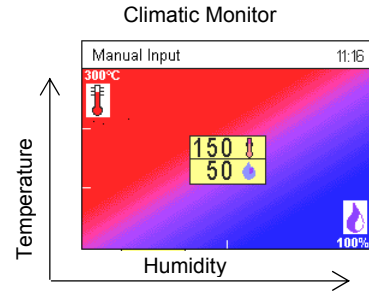
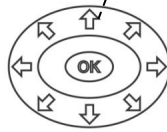

A short touch of any arrow changes inputs step by step. If you keep the arrow pressed, changes are executed quickly.

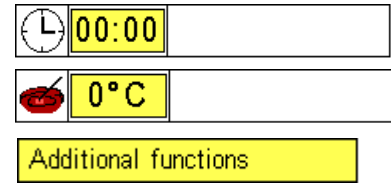
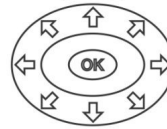

Press **OK** to confirm every input or setting.

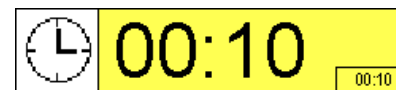
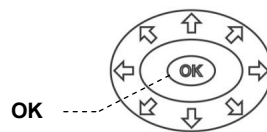

2.3 Manual operation

As soon as the unit is connected to the mains, the Eloma standby screen appears.

Touch master key  to switch on, the start-up screen appears.

The red part of the screen represents dry heat, the blue one moist heat.

The Climatic® Cursor indicates the temperature in degrees in relation to the humidity percentage. Move it in all directions.

Climatic Cursor

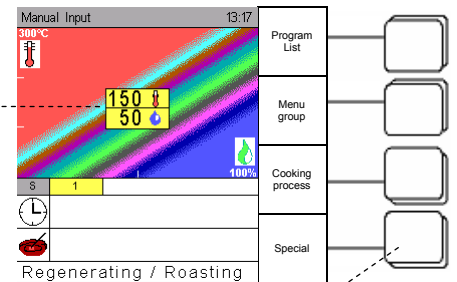

Sensor keys

Allocation of sensor keys

Press sensor keys to call the different menus. Examples below

Program List	10:28	Manual Input	Menu groups	10:00	Manual Input	Cooking process	10:00	Manual Input	Special Program	08:20	Manual Input
002 ☺ Roast beef		Manual Input		Program list	Manual Input		Program list	Manual Input	Regenerating	Manual Input	Special
003 Chicken											
004 ☺ Roast veal											
000 Broccoli											
001 ☺ Roast Pork		Favourites		Cooking process		Cooking process		Cook & Hold		Autoclean	
		Preheat OFF		Special program		Special program		ΔT-Cooking		HACCP	
								Baking			

3. Start-up in manual operation

Prior to start : **Open water tap.**



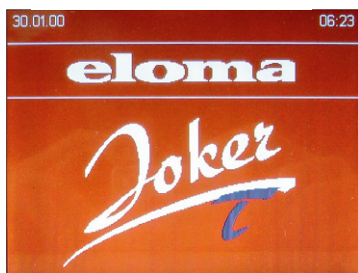

Press key **ON/OFF**, a start-up screen appears. The appliance is ready for work. LED is lit.

Eloma Standby-screen

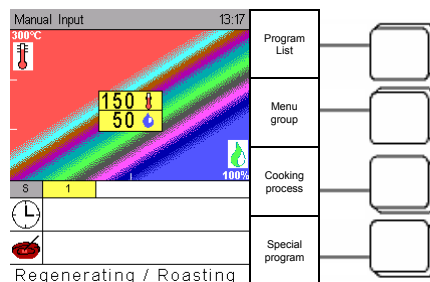

Start-up screen



- As standard the operation mode display indicates **manual input** is set as first start-up screen.
- Press sensor key **Special program**, **Special** and select **Setup** with direction arrows and confirm with OK.
- Select **Start Screen** and select the desired startup screen.
- Five possibilities are available:
Manual input – Favourites – Program list – Cooking procedure – Menu group.
- **The basic setting in the Climatic Cursor after ON/OFF  is temperature T = 150° C and humidity H = 50%.**
- Below in horizontal lines “time” and “core temperature” symbols are displayed.

3.1 Manual input

- Use the Scout to select a cooking procedure by adjusting the desired temperature and humidity level. The Climatic cursor moves accordingly. Confirm with **OK**.
- When moving the Climatic cursor, the „Info line“ indicates the following cooking procedures:

Indication Cooking procedure	Input		
	Temperature range in °C / °F		Humidity range in %
Defrosting	30 – 45	86 – 113	50 - 100
Poaching	60 – 90	140 – 194	90 - 100
Stewing	90 – 100	194 – 212	80 - 100
Steaming	95 – 130	203 – 266	60 - 100
Regenerating	90 – 160	194 – 320	25 - 75
Baking	120 – 220	248 – 428	0 - 30
Roasting	150 – 230	302 – 446	0 - 50
Grilling	180 – 275	356 – 527	0 - 10
Gratinating	220 – 300	428 – 572	0 - 5

- After selection of a cooking procedure and **OK**, you must set – time – or core temperature.

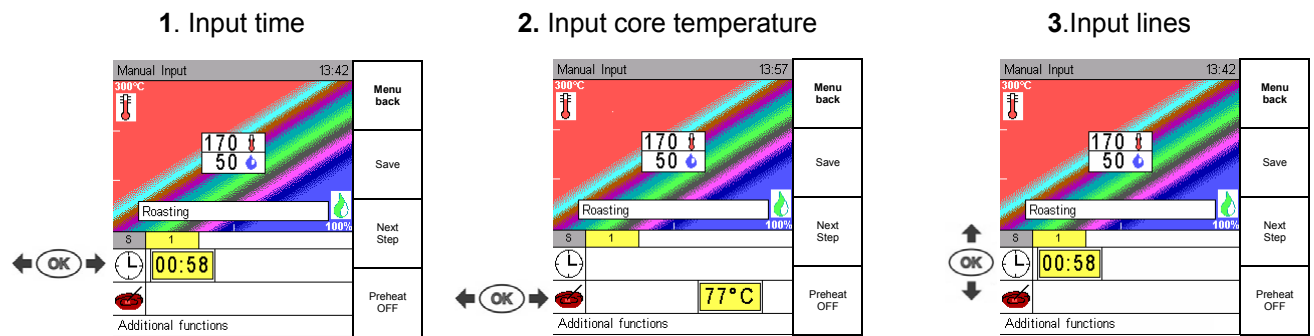

- Four-figure time display from 00:00 to 23:59.

- Time:** Basic setting is 00:00 move arrow \leftarrow to get to ∞ = continuous operation. Time setting is 23:59 move arrow \rightarrow and you get again ∞ = continuous op. Setting is ∞ move arrow \leftarrow and you get to 23:59 Setting is ∞ move arrow \rightarrow and you get to 00:00

- Core Temperature** Core temperature range from 0° C to 99° C.

- Use the direction arrows \uparrow and \downarrow to change between the input fields for time, core temperature and the Climatic Cursor for Temperature/Humidity.

3.2 Manual operation – Input of one step

- Input parameters, “temperature/humidity“ and “time“ or “core temperature“ and start the Joker LED START is lit.
- If desired, you can activate the preheating by pressing the key **PreHeat** see Sec. 9.
- The Climatic Monitor indicates data of the advancing program.

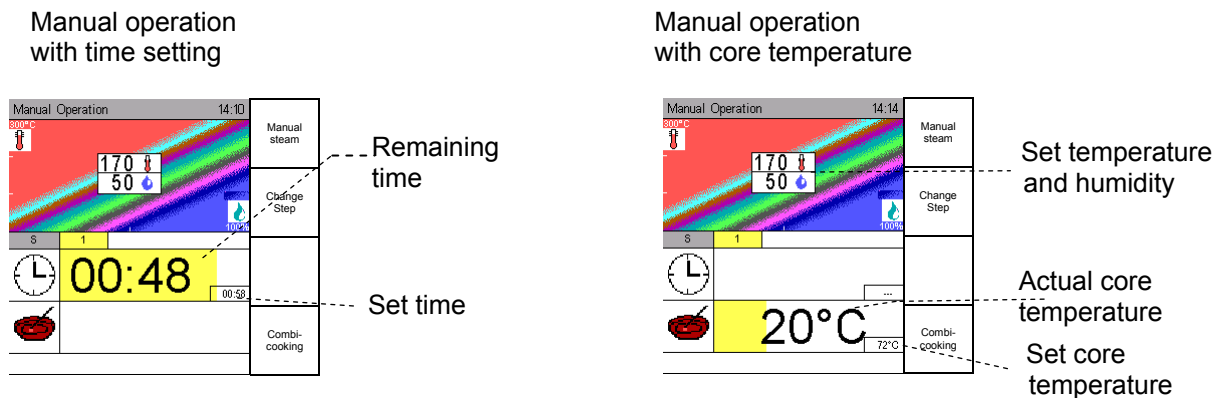

- There are yellow bars in the input fields indicating the current state of the program.
- Time** : Bar is getting shorter to the left, time is running down.
- Core temperature**: Bar is getting longer to the right until the desired core temperature is reached.
- Man. Steam**: An additional manual humidification is always possible as long the key “Man. Steam” is pressed.
- A sound signal announces the end of the program.

3.3 Manual operation – Input of two steps (Steptronic ®)

Example 1

1st step → Input 190°C, 50%, Time 10 minutes

2nd step → Input 220°C, 20%, Time 15 minutes

Input 1st step

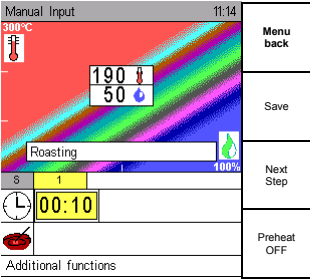

Input 2nd step

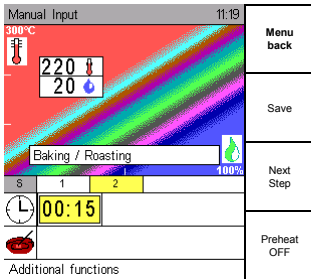

Manual operation

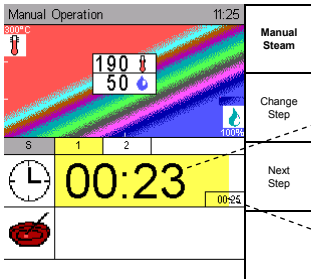

START STOP

Remaining time

Total time Step 1+2

Example 2

1st step → Input 140°C, 50%, Core temperature 72°C

2nd step → Input 170°C, 10%, Core temperature 78°C

Manual Input

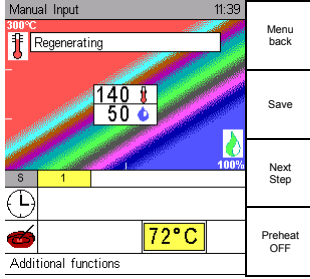

Manual Input

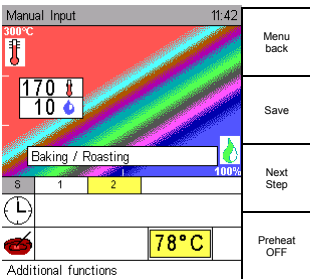

Manual Operation

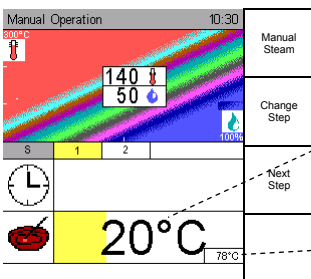

START STOP

Actual core temp.

Set final core temperature step 2

3.4 Manual operation – Input of several steps (Steptronic ®)

- (Steptronic ® allows to combine several steps, also time and core temperature combined.)
- Input of the first cooking step as described in Sec. 4.
- To proceed to a second step, press touch key **Next step** and repeat input as described before.
- Continue until all desired steps are entered and press START.
- The actual situation of the program is displayed step by step.
- Up to 20 cooking steps are possible.

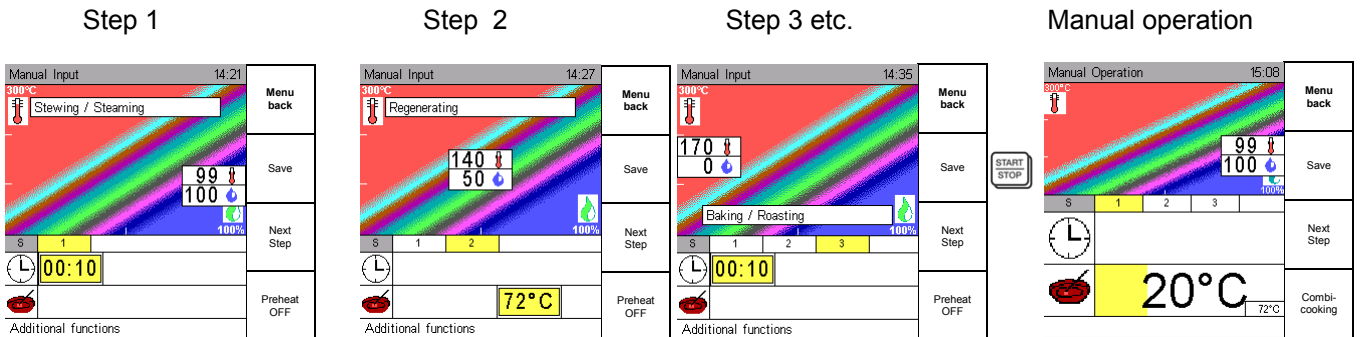

- The first four steps are indicated, yellow bars with step number, further steps to a program are displayed once the first four steps have been executed.
- To control previous steps, just touch briefly, 1 second, “Menu/back“.
- If you keep this touch pressed too long (3 seconds), you return to the start-up screen and entered, not stored data is lost.

3.5 Display of the actual situation (Steptronic ®)

- **Exmpl:**
- A program consisting of several steps was entered, the second step including core temperature control and the third one a time setting.
- In this case, the remaining cooking time is only displayed while the third step is running down, the core temperature has been reached.

1. Step → Input: Time 10 min
2. Step → Input: CT 72°C
3. Step → Input: Time 10 min

Actual situation step 1

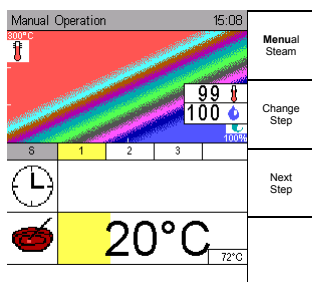

Actual situation step 2.

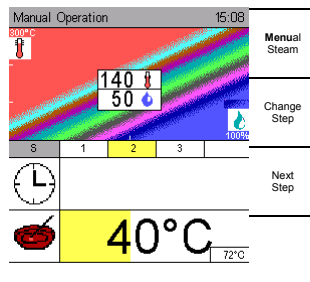

Actual situation step 3.

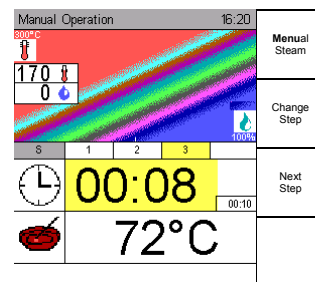

- The actual situation of temperature and humidity are displayed for 5 seconds see Sec. 3.6.
- If the sensor key manual steam is pressed, water is evaporated in the cooking chamber.

3.6 Display of actual values (Steptronic ®)

- While a program is running down, touch one of the direction arrows and the actual values for temperature and humidity are displayed for 5 seconds.
- Then the display returns to the desired set values.
- The core temperature field displays constantly the actual core temperature and at the right corner the adjusted core temperature.

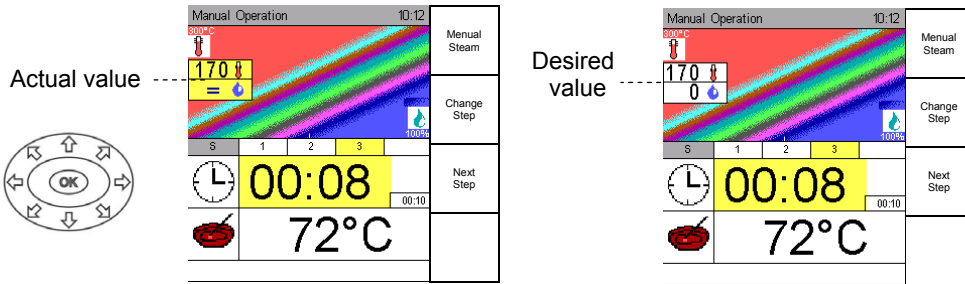

- Basis of the indication is the actual humidity level.
- The actual value is considered to be within the tolerance if the humidity level is +/- 10% of the desired/set value.

Next step

- Press the function key **Next step** to display the next cooking steps while running a cooking programme.

Change step

- Press the function key **Change step** to display and change the settings for a cooking step while running a cooking programme.
- With the function key Save changes, the changes will be active for the running programme.

Abnormal program end

- Pressing key  while a program is running down, terminates the program. The monitor display returns to the initial input screen. All data remain stored.



Program end

- The appliances switches off automatically, LED is lit, the sound signal of 30 seconds can be stopped immediately by pressing key  or by opening the door.
- The screen returns to the initial input screen.

Indication while buzzer sounds

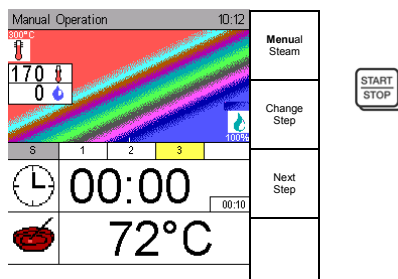

Indication after Start/Stop

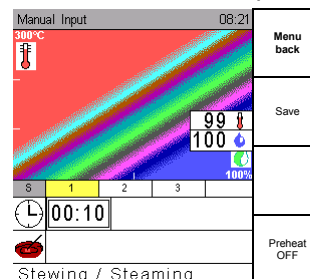

Memory :

After abnormal program stop or program end, data remain stored and the same program can be started once again.

3.7 Additional functions

- Go to Additional functions to select further functions.
- Enter manually temperature/humidity and time or core temperature, confirm with **OK**.
- Go to “Additional”, using arrow ↓ and proceed as described.

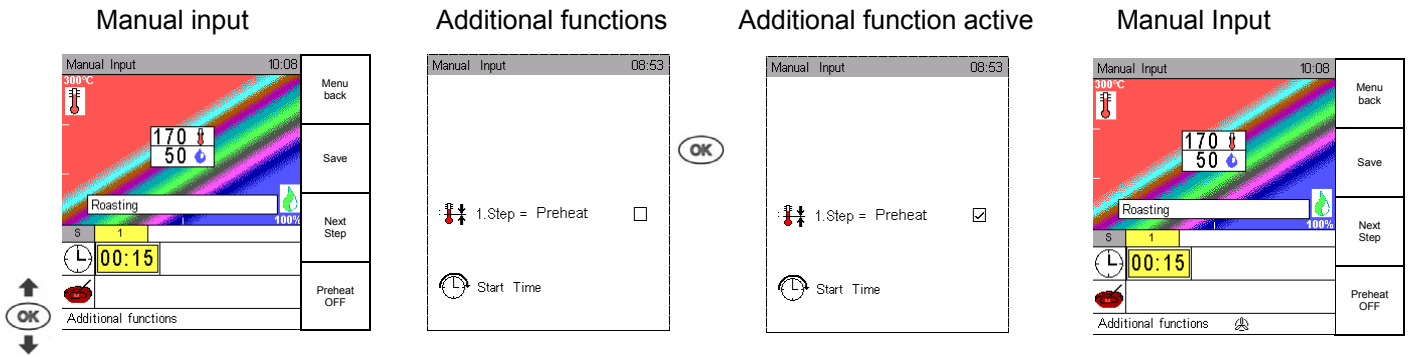

- Select or, as the case may be, cancel function by pressing **OK**, “✓” appears respectively disappears.
- Touch briefly key “Menu back” to return to the initial input screen. The selected additional function “Reduced fan speed” is now mentioned in the Info Line.
- Reduced fan speed, if activated “✓”.
- if activated, the first step of a cooking program is defined as preheating step.
- Start Time , program start can be pre-programmed.

3.8 Delay start programming – Manual input

- Go to **Additional** and use Joker Scout arrow ↓ to proceed to “Delay start”, confirm with **OK**.
- Enter desired start time using Joker Scout arrows ↑ or ↓ and press key

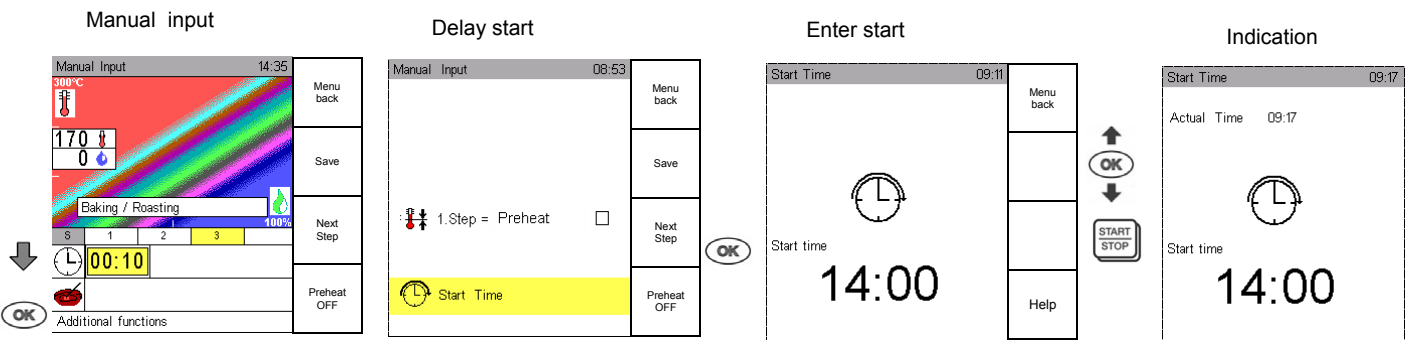

- The appliance is now in a waiting position and cannot be used unless – delay start programming is cancelled by pressing key .

The monitor returns automatically to the initial input screen and the program can be started by pressing key .

4. Cooking procedures

For a shortcut to the temperature/moisture parameters necessary for the desired cooking procedure, you can use the screen "Selection cooking procedures". To select preset temperature/humidity parameters press cooking process.

Once in the cooking process, press the Joker Scout arrow keys to select the desired cooking procedure. Once you selected and entered your choice, the interface for the cooking procedure definition opens. The Climatic Cursor on the Climatic Monitor shows the predefined values for temperature and humidity. Proceed with the other settings as usual.

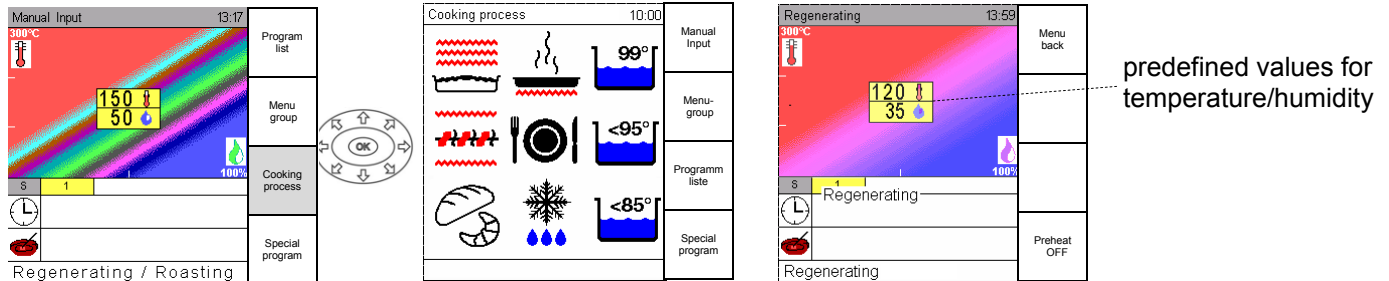

Symbol/Display	Cooking procedure	Values Temperature/Humidity
	Gratinating	230/0
	Roasting	130/30
	Steaming	99/100
	Grilling	180/0
	Regenerating	120/35
	Stewing	95/80
	Baking	160/10
	Defrosting	30/60
	Poaching	85/100

The Climatic Cursor on the Climatic Monitor shows the predefined values for temperature and moisture.

- After accepting the predefined parameters "temp/moisture", other cooking steps can be entered, as described in Sec. 3.4.
- You can save and assign the cooking programmes of a menu group, as described in Sec. 5.1.

5. Program Storage

Program number

Input field name

Input field number

<< Cursor to the left

>> Cursor to the right

⌫ Delete characters to the left

⌮ Delete characters to the right

Name proposals

Info line

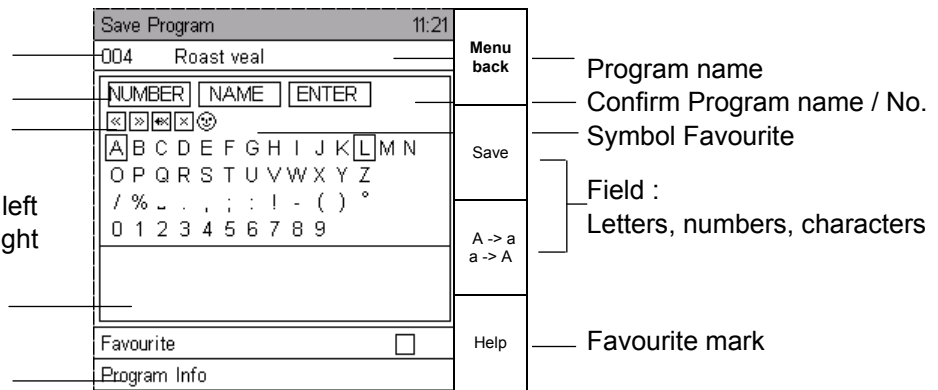

5.1 Save Programs

- Enter any program and touch sensor key **Save**.

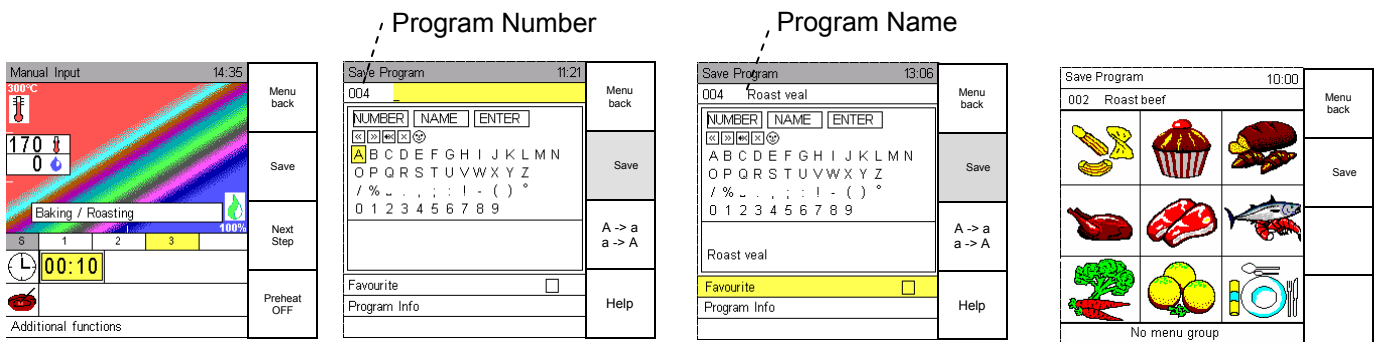

- The program number is preset, but can be changed. For new cooking program, the next unassigned program number is suggested.
- For writing program names, select the letters/number with the Joker arrow keys and confirm with **OK**. The maximum length of **programme names** is 22 characters. Press the sensor key **Save** to save the program. The menu interface with the suggested menu groups opens. Assign program to a menu group or save without a program group. Press the sensor key **Save** to save the program. With **Start**, you can start the program, or you can go back to the start-up screen. If you want to enter more information, follow these instructions: After entering the program name, use the Joker arrow keys to select Enter and confirm with **OK**. You can highlight the program as a favourite with **OK**. With **Program Info**, you can enter more information about the cooking program.

Select and edit a program name out of the name proposals

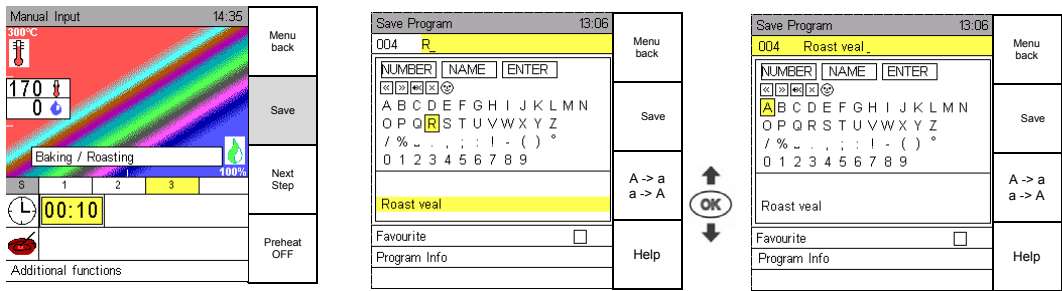

- Use Joker direction arrows to bring up the first letter, confirm with **OK**.
- Use Joker Scout arrow ↵ to bring up name proposals.
Two already existing program names starting with the same letter are displayed.
- Use Joker Scout arrow ↵ to bring up further program names, starting with the same letter, if available.
- Confirm a proposal with **OK** and change or complete the program name.
- Go to **Enter** to save the program.
- For further inputs see Sec. 5.1.

Change Program numbers

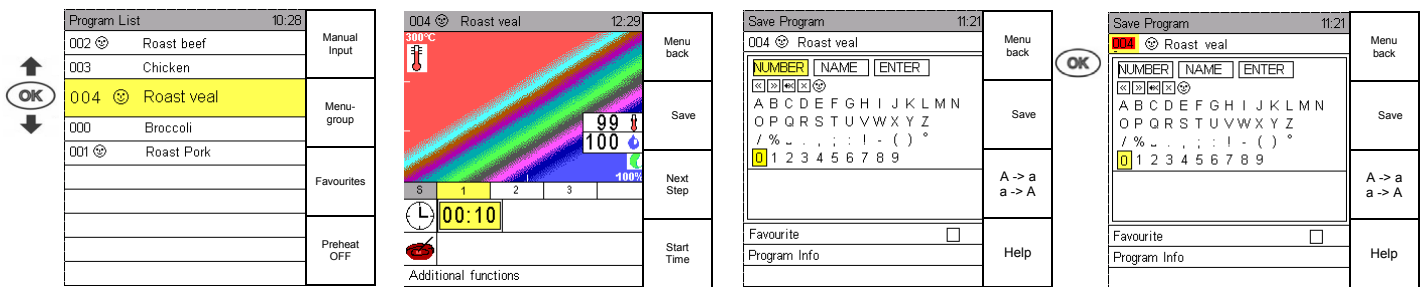

- Select program and confirm with **OK**.
- Press sensor key **Save**.
- Use Joker Scout direction arrows and proceed to input field "Number", confirm with **OK**.
- The input field "Number" is marked yellow and the number can be changed.
- In case the new number is marked red, this number has already been allocated, however, it can be overwritten.
- Press sensor key **Save** to return to the input screen.

Select a program to be a Favourite

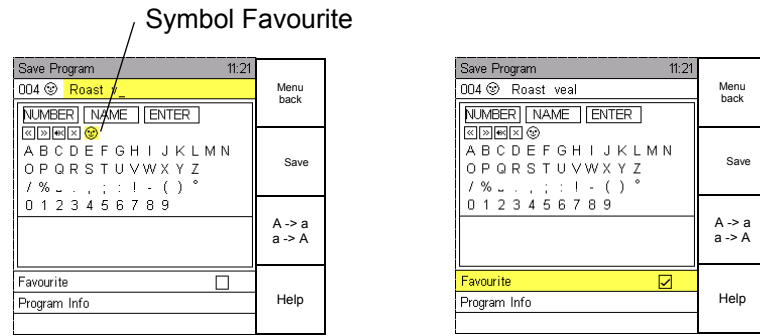

- We recommend to mark programs that are frequently used to be **Favourites**. It is then possible to create the list of favourites, facilitating a quick search.
- **Two possibilities to mark a Favourite:**
 1. Set the cursor to the symbol favourite ☺ and confirm with **OK**
 2. Confirm program name with enter, the cursor goes to "Favourite". Confirm with **OK**, it is marked „✓“.

Program Info

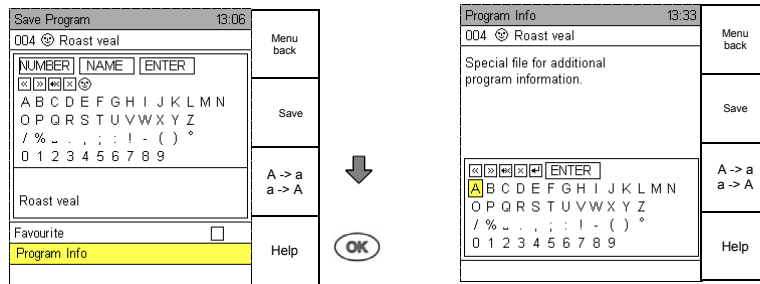

- Use Joker Scout arrow ↓ and go to "Program Info", confirm with **OK**, the input field appears and it is now possible to enter individual, additional information to this program – see Sec. 5.1.
- When such a program is saved, the symbol "i" appears in the program list.

5.2 Delete a Program

- Bring up the program from the program list and confirm with **OK**.

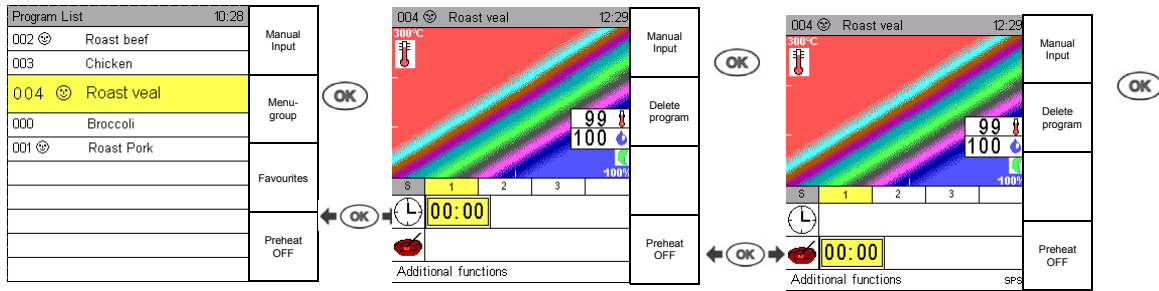

- Set the time or the core temperature to "0" " and press sensor key **Delete program**.
- The complete program is deleted.

5.3 Copy a Program

- Saved programs can be overwritten or copied.
- Bring up the program and confirm with **OK**.

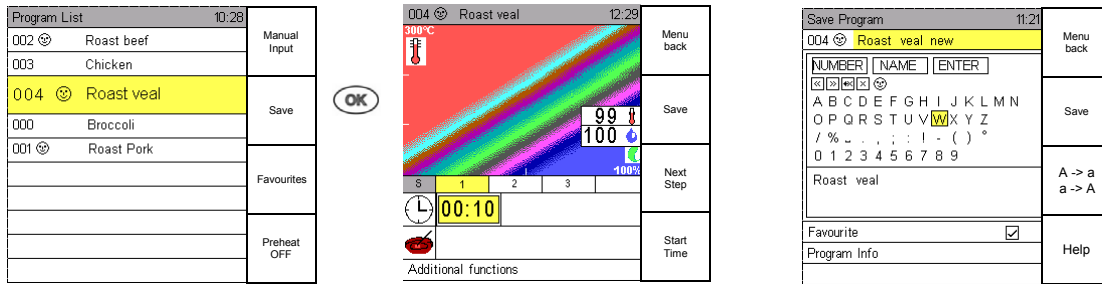

- Press sensor key **Save**.
- See Sec. 5.1 and write the new program name and/or number, confirm with "Enter".
- Press sensor key **Save**, the program is copied or overwritten. Thus the same program can be saved several times with different names.

5.4 Select and start a Program from the Program List

- Touch sensor key **Program List** to bring up all saved programs, maximum 300.

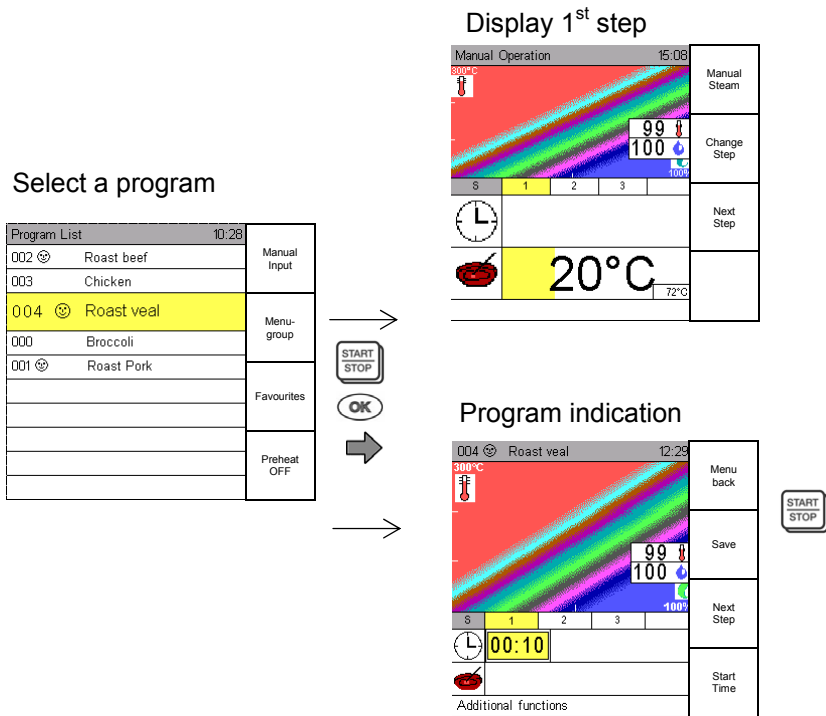

- Use Joker direction arrows ↑ and ↓ to select a program.
- Press Start/Stop to start this program immediately.
- Press **OK** to have it displayed for information and continue with Start /Stop.
- “Program information” is available through the directional arrow →.

5.5 Select and start a Program from the Favourite List

- **Favourites** are marked with the smiley ☺ .
- Press sensor key **Favourites** to bring up the list and use the Joker Scout arrows ↑ or ↓ to select a favourite.

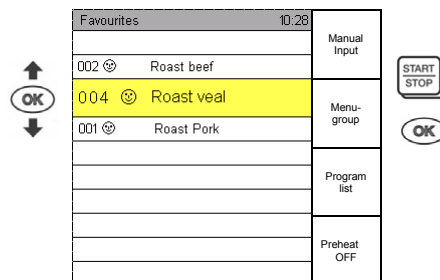

- Press Start/Stop to start this program immediately.
- Press **OK** to have it displayed for information and continue with “Start /Stop”.

5.6 Delayed start in program operation

- The start of a program can be delayed for up to 24 hours.
- Select a program from any list and confirm with **OK**.
- Press sensor key **Start time**.
- Use the Joker Scout arrows ↓ or ↑ to set the start time and start pressing  key.

Program selection

Program List	10:26	Manual Input
002 ☺ Roast beef		
003 Chicken		
004 ☺ Roast veal		Menu-group
000 Broccoli		
001 ☺ Roast Pork		
		Favourites
		Preheat OFF

Select "Start time"

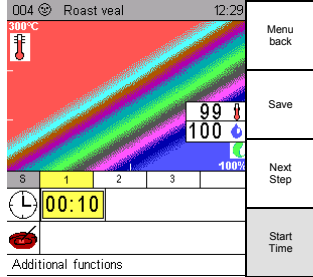

Set Start time

Start Time 11:57

004 Roast veal

Start time

12:00

Menu back



Help

004 Roast veal 11:00

Actual Time 11:00

Start time

12:00

- To stop this function, press  key.
- The start screen displaying the program reappears. By pressing  key, the program can be started immediately.

6. Menu groups in fully automatic operation

6.1 Select and start a program via menu group

With the sensor keys **Program List**, **Favourites** and **Menu Group**, you can open the display **Menu Group**.

Use the arrow keys to select the desired menu group, the middle is selected with the **OK key**.

With the Joker Scout arrow keys ↓ and ↑ you can select the program saved in the respective menu group.

Press Start/Stop to start it right away or display it by pressing **OK** and then start it with "Start/Stop".

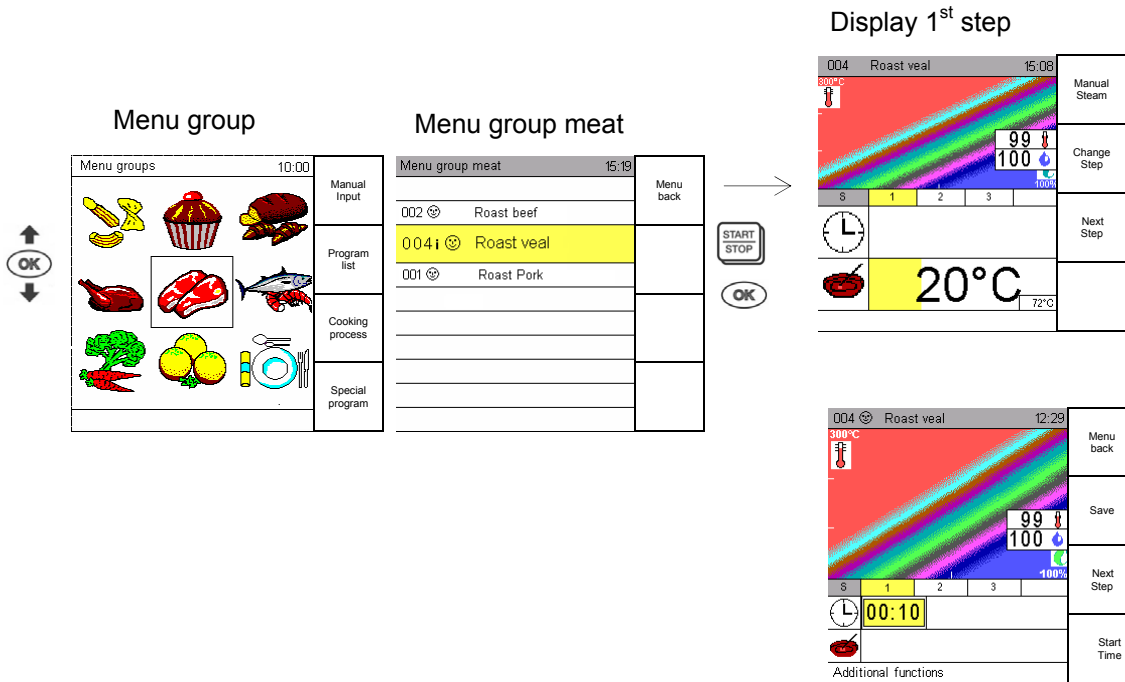

6.2 Picto operation

If only one program belongs to a menu group, the program opens directly if you select that menu group.

If you select Menu Group as your start-up display and have only 1 program in each of the menu groups, you can run the so-called picto operation:

Turn on the appliance, select Menu Group and start the respective programme.

7. Special Programs

- Touch sensor key **Special Program** to bring up further special programs and functions.

7.1 Regenerating

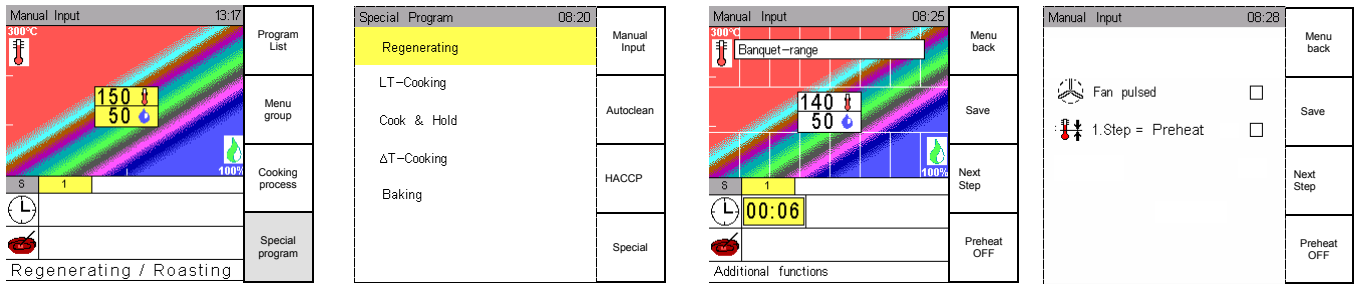

- Press sensor key **Special program** and confirm **Regenerating** with **OK**.
- The Climatic monitor indicates between the striped field the banquet cooking range for temperature/humidity. Standard setting for banquet is **140°C and 50% humidity**.
- Use Joker Scout arrows to determine temperature/humidity and confirm with **OK**.
- Input range: **Temperature 90°C –180°C; humidity level 0 - 100%**
- Select function **Preheat** as described in Sec. 9.
- It is possible to enter up to 5 different cooking steps in a banquet program, see Sec. 3.4.
- Use Joker Scout arrow \downarrow , set the time and start .
- To save a banquet program, follow the instructions in Sec. 5.1.
- When such a program is saved, the letter “B” appears automatically at the beginning of its name, in order to identify it in the program list.

Additional functions “regenerating“ :

- Use Joker Scout arrow \downarrow , go to line “Additional” and select additional functions.
- Use Joker Scout arrows \uparrow or \downarrow for selection.
- Confirm functions to be **On** or **Off** with **OK**, a selected function is marked “✓”.
- If the function “fan pulsing“ is used, the humidity level is adjusted accordingly.

Stop banquet program:

- By pressing the Start / Stop key, the banquet program can be stopped.
- In the info line appears “Banquet-range“.

End of the program:

- Signal sounds.
- Open the door and take out the food.
- Close the door.

Memory

- Pressing "Start / Stop", the same banquet program can be repeated.

7.2. LT-Cooking (Low temperature)

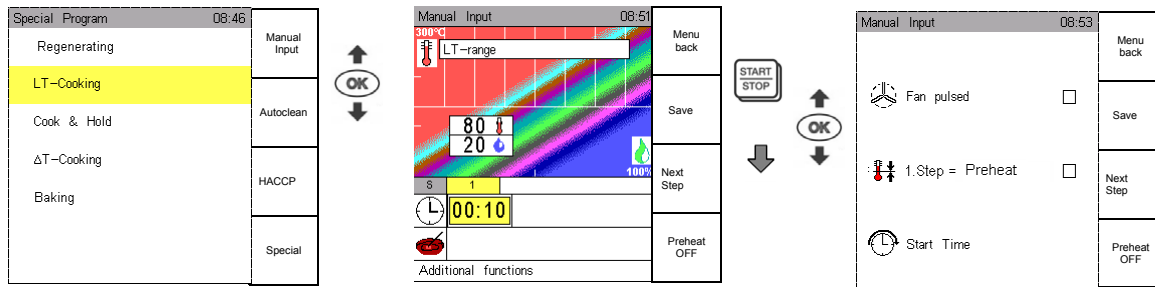



- Touch sensor key **Special program**, use Joker arrow ↓ to select **LT cooking** and confirm with **OK**.
- The Climatic monitor indicates below the striped field the LT cooking range for temperature/humidity. Standard setting for LT cooking is **80°C** and **20% humidity**.
- Use Joker Scout arrows to determine temperature/humidity and confirm with **OK**.
- Input range: Temperature **30°C – 150°C**; humidity **0 – 100%**
- As soon as this range is left, standard cooking processes are displayed. Consequently for instance it is possible to start roasting at higher temperatures.
- Select function **Preheat** as described in Sec. 9.
- It is possible to enter up to 12 different cooking steps in an LT program, see Sec. 3.4.
- Use Joker arrow ↓, set time and/or core temperature and start
- To save an LT program follow the instructions in Sec. 5.1.
- When such a program is saved, the letters **LT** appear automatically at the beginning of its name, in order to identify it in the program list.

Additional functions “LT cooking“:

- Use Joker arrow ↓, go to line **Additional** and select additional functions.
- Use Joker Scout arrows ↑ or ↓ for selection.
- Confirm functions to be on or off with **OK**, a selected function is marked “✓”.
- If the function “fan pulsing“ is used, the humidity level is adjusted accordingly.

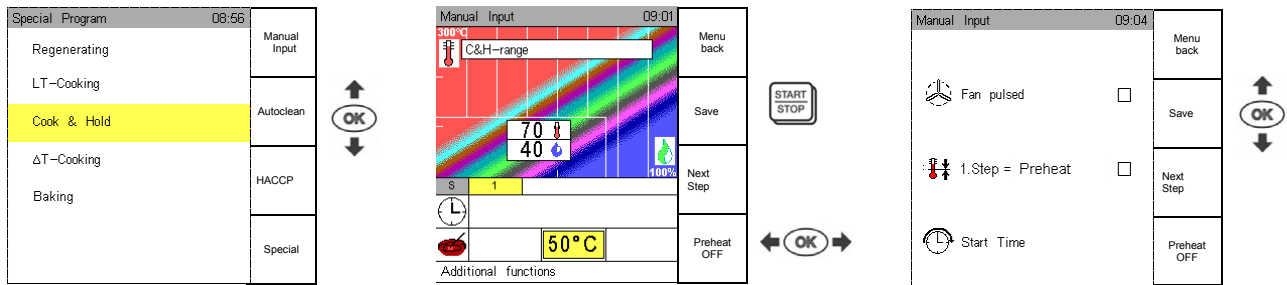
7.3 Cook & Hold



- Touch sensor key **Special Program** , use Joker arrow ↓ to select **Cook & Hold** and confirm with **OK**.
- The Climatic monitor indicates the Cook & Hold range for temperature/humidity. Standard setting for Cook & Hold is **70°C** and **40% humidity**.
- Use Joker Scout arrows to determine temperature/humidity and confirm with **OK**.
- Input range: **Temperature 30°C - 120° C, humidity level 0 – 70%**
- As soon as this range is left, standard cooking processes are displayed. Consequently for instance it is possible to start roasting at higher temperatures.
- Select function **Preheat** as described in Sec. 9.
- It is possible to enter up to 5 different cooking steps in a Cook & Hold program, see Sec. 3.4.
- Use Joker arrow ↓, set time and/or core temperature and start 
- To save a Cook & Hold program follow the instructions in Sec. 5.1.
- When such a program is saved, the letters “**C+H**” appear automatically at the beginning of its name, in order to identify it in the program list.

Additional functions “Cook & Hold”

- See LT Cooking.

7.4 Delta-T- Cooking

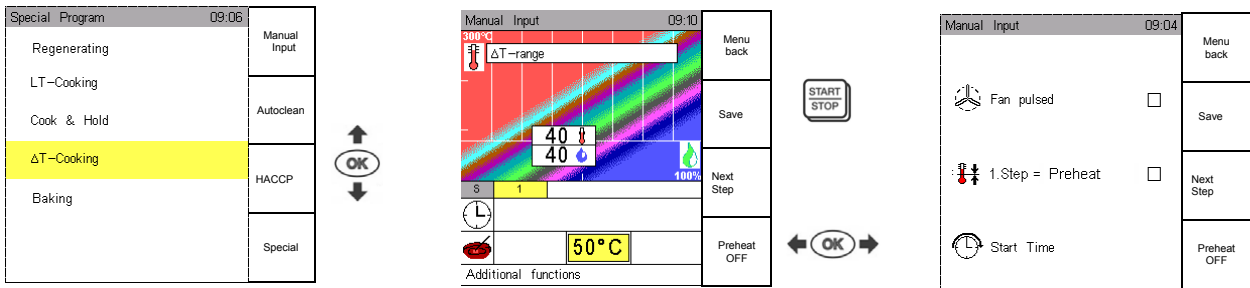

- Touch sensor key **Special Program**, use Scout arrow ↓ to select **ΔT-Cooking** and confirm with **OK**.
- The Climatic monitor indicates the ΔT-Cooking range for temperature/humidity. Standard setting for ΔT-Cooking is **40°C** and **40% humidity**.
- Use Joker Scout arrows to determine temperature/humidity and confirm with **OK**.
- Input range: **Temperature 20°C - 80°C, humidity level 0 – 100%, CT 0 – 99°C**
- Select function **Active temp** as described in Sec. 9.
- It is possible to enter up to 5 different cooking steps/modes in a ΔT-Cooking program, see Sec. 3.4.
- Use Joker Scout arrow ↓, set the core temperature and start
- To save a ΔT-Cooking program follow the instructions in Sec. 5.1.
- When such a program is saved, the characters “ΔT” appear automatically at the beginning of its name, in order to identify it in the program list.
 - **In a ΔT cooking process, the cooking chamber temperature is adjusted to the increasing core temperature.**

Example:

- Input ΔT = 50°C, core temperature 65 °C.
- The ΔT – program is started, the actual core temperature is displayed, e. g. 20°C.
- ΔT = 50°C is added to the actual core temperature to determine the cooking chamber temperature - at this moment $CT\ 20^{\circ}C + \Delta T\ 50^{\circ}C = 70^{\circ}C$.
- In the course of an advancing cooking process the core temperature is increasing constantly and the cooking chamber temperature as well according to ΔT, e.g. $CT\ 35^{\circ}C + \Delta T\ 50^{\circ}C = 85^{\circ}C$ cooking chamber temperature.
- Once the core temperature of 65°C has been reached, the cooking chamber temperature will be $CT\ 65^{\circ}C + \Delta T\ 50^{\circ}C = 115^{\circ}C$.

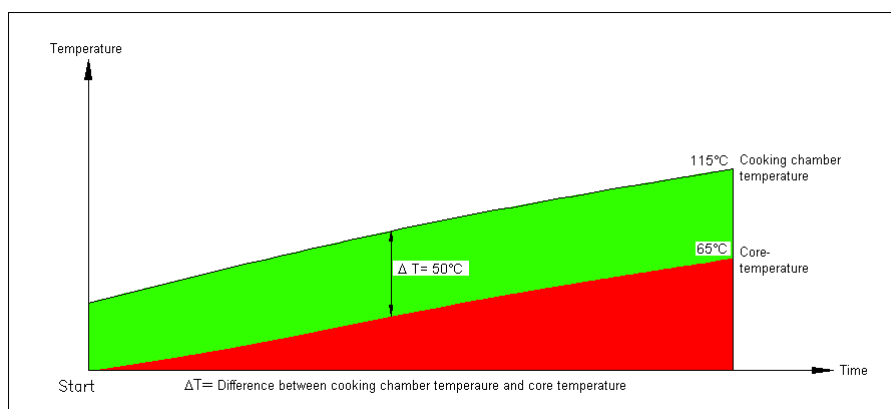

Additional functions “ ΔT cooking“:

- See LT Cooking

7.5 Baking

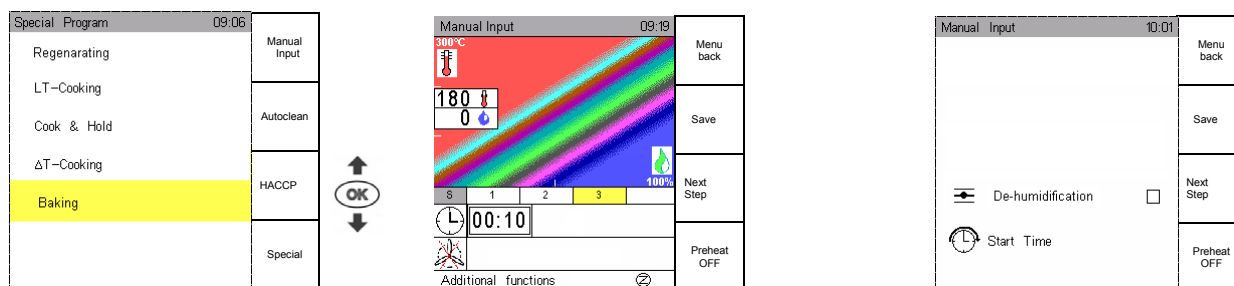

- Touch sensor key **Special programs**.
Use the Scout arrow ↓ to select “Baking” and confirm with **OK**.
- With the Climatic Cursor the temperature/steam quantity can be set.
- Input range: temperature **0°C – 300°C**, and steam quantity **10 – 1000 ml** or seconds.
- Standard setting for baking is **temperature 180°C** und **steam quantity is 0**.

Manual baking program.

1. Use Scout arrows to determine temperature between **0°C – 300°C**.
2. Use Scout arrows to determine the steam quantity: **10 –1000 ml** or **0**. Gradation in 10 ml steps.

If the steam injection quantity is **"0"** in the first baking stage, and confirmed with **OK**, on the time display appears **00:00**, and the baking times between **00:00** and **23:59** can be entered using the arrow-keys. ← **OK** →.

If the steam injection quantity is **">0"** in the first baking stage, and confirmed with **OK**, on the time display appears **00:00**, and the baking times between **00:00** and **23:59** can be entered using the arrow-keys. ← **OK** →.

After input of the baking time and confirmation with **OK** the display “break time” indicates **0 sec..** Set the rest time between **0-99 seconds** with the arrow keys ← **OK** →. You can set rest time **0**, too.

- When baking step input, **the time must always be entered**, if not, the following data will not be accepted.
- The appliance always has to be preheated. Select function **Active temp** as described in Sec. 9.
- It is possible to enter several baking steps in a bake program, see Sec. 3.4.
Up to 20 baking steps are possible.
- Start the device with
- To save a baking program follow the instructions in Sec. 5.1.

Additional functions:

- If the sensor key **manual steam** is pressed, water is evaporated in the cooking chamber.
 - Use the Joker Scout arrow ↓, go to line **“Additional”** and select additional functions.
- Use the Joker Scout arrows ↑ or ↓ for selection.
 - Confirm functions to be **On** or **Off** with **OK**, a selected function is marked “✓”.

Stop the bake program

- To stop this function, press key.
- The info line indicated "Bake."

Program end:

- Once the baking time has run down, there is sound signal.
- Open the door and take out the baked food.
- The same baking program may be started again with .

8. Combi cooking

Combi cooking can be selected manually or while running a program.

Different cooking program can be started at different times.

The sensor key **Combi Cooking** is available:

1. during cooking
2. if you have pressed Preheating, after the Active Temp procedure.
3. in a multi-step program during the Active Temp procedure of the last cooking step.
 - Manual selection as described in Sec. 3.1, select a cooking program from the program list or select a cooking procedure.
 - Start the programme with **START/STOP**
 - With the sensor key **Combi Cooking**, other cooking program can be selected from the program list with a cooking step and time conditions. Start them with **OK**.
 - The remaining time of the started program is displayed.
 - If you started cooking procedure with KT temperature originally, that procedure's core time and the remaining times of the other started program are displayed.

Display 1

Manual Operation 11:10		Manual Steam
170 50		Change Step
00:50		Combi-cooking
S 1		SFS

Display 2

Combi-Cooking selection 15:00		Menu back
040	Cevapcici	
041	Potato Wedges	
035	Baked Potatos	
069	Bosom Pork	

Display 3

Combi-Cooking in operation 15:00		Manual Steam
040	Cevapcici	00:08
041	Potato Wedges	00:18
035	Baked Potatos	00:48
069	Bosom Pork	00:50
		Combi-cooking

Display 5

Combi-Cooking in operation 15:10		Manual Steam
040	Cevapcici	00:00
041	Potato Wedges	00:10
035	Baked Potatos	00:40
069	Bosom Pork	00:40
		Change Step
		Combi-cooking

- If one hourglass is finished, display shows **00:00**, it is marked with an acoustic signal, and the line is highlighted in colour.
- Open the door of the combi steamer, take out the cooked items.

Display 6

Combi-Cooking in operation 15:10		Manual Steam
041	Potato Wedges	00:10
035	Baked Potatos	00:40
069	Bosom Pork	00:40
		Change Step
		Combi-cooking

- The display of the expired program vanishes.
- The hourglass jumps to the cooking program with the next-shortest time left.
- With **Start/Stop**, you can interrupt the **Combi Cooking** operation; the display changes to manual, see Sec. 3.1.
- When all **Combi Cooking** operations are done, the display changes to manual, see Sec. 3.1.

9. Preheat – Cool Down Active Temp

For all cooking programs and for the special programs:

- Banquet,
- LT-Cooking,
- Cook&Hold,
- ΔT-Cooking,

it is possible to add the function “**Active Temp**”.

When selecting the function “Active temp” the temperature in the oven cavity is brought to a pre-set nominal temperature.

In case the cooking chamber temperature is below this nominal value, the cavity is heated up.

In case the cooking chamber temperature is too high for the following cooking program, the cavity is cooled down with the function “cooling” (Cool Down).

At very high temperatures the cooking chamber is first cooled by air, then by steam generation and at a temperature below 100 ° C additionally with direct injection of water through the nozzle autoclean.

This additional function “cool down” (Cool Down) can be disabled with the touch keys:

- Special Program
- Setup
- Service
- Unit parameters (see Sec. 11.2.4 → Unit Parameters).

“**Active Temp**” has only preheat (in this case).



While in “**Active Temp**” there should be no food in the unit.

The charging is done only when requested by acoustic signal and text „Preheat End“.

There are two possibilities:

1. Function “**Active Temp**” defined as first step of a multi-stage cooking program

In this case preheat / cool is defined as the first step of the cooking program.

- Setting the desired temperature in the first step and desired time plus the additional activation of function “**Active Temp**”. All other steps are programmed as usual. The program is started by pressing .
- Any opening of the door during preheating, interrupts the preheat process.
- Close the door and preheat is continued until the pre-set nominal temperature is reached.
- Once it is reached, there is a sound signal and the info line indicates Preheat End.
- The sound signal is repeated over and over again until the door is opened.
- The nominal temperature is maintained for 1 hour max.
- Charge the oven and shut the door. The program starts automatically with the previously entered cooking steps.
- Once the preheating process is stopped by the operator touching the sensor key **Preheat OFF**, it is possible to start directly with the first cooking program step after having charged the oven.
- Such a program, including preheating, can also be stored. The symbol  is then marked in the program list.

10. HACCP

An annular memory can save up to 200 programs. All processing data is recorded continuously and automatically.

Once a cooking program is terminated with “Start/Stop” or through automatic switch off at program end, its protocol is stored. The cleaning program Autoclean is also stored.

10.1 Serial Interface – Connecting cable

Protocols may be printed by means of connecting the steamer to a printer capable of printing at least 40 characters per line. Printer adjustment : 9600, N, 8, 1.

The port for the cable connection is on the right side of the control panel.

Plug No.:
EXTERN 9pin. Min-D
bushing

Function:
RS 232 C Serial Interface
(9600, N, 8, 1)
9600 BAUD, 8 databit,
EVEN PARITY,
1 STOPBIT

→
**Connect
printer**

Controls

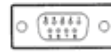

Bushing top view

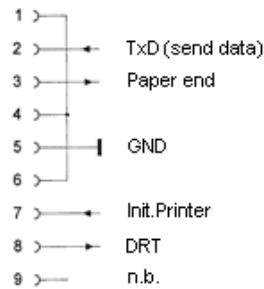

Setting of DIP Switch Thermal Printer NP 104

1. Parallel Interface (DIP Switch 1)

	1	2	3	4	5	6	7	8
ON	ON	ON	ON	ON	ON	ON	ON	ON
OFF	OFF	OFF	OFF	OFF	OFF	OFF	OFF	OFF

Switch	SOLL
1	CR/LF: Carriage Return + Line feed
2	40 Columns
3	Normal Character
4	Normal Zero
5...7	German
8	Not defined

2. Serial Interface (DIP Switch 2)

	1	2	3	4
ON	ON	ON	ON	ON
OFF	OFF	OFF	OFF	OFF

Switch	SOLL
1	Parity Check
2	Even Parity
3, 4	9600 bps

10.2 Selection and printing of recorded cooking processes



The connecting cable shall only be plugged or unplugged if both, the steamer and the printer, are switched off, otherwise the control unit or the printer may be damaged

- The appliance must be switched on with no program in progress. Any exact HACCP recording presupposes the correct setting of the real time. Refer to Sec. 11.2.1.
- Touch sensor key **Special Program** and select HACCP with the sensor key.
- A list appears stating day and date, one day being marked yellow.
- Use Joker Scout arrow \updownarrow to scroll the HACCP list upwards to the desired day then marked yellow.
- Touch sensor key **Print** to have the protocol of this day printed.
- Once a week day is marked yellow and confirmed with **OK**, the individual programs of this day can be selected by scrolling with the Joker arrows. Confirm the program that is supposed to be printed with **OK** and touch sensor key **Print** to have it printed.
- By pressing sensor key **Print 7** the programs, including Autoclean, of the last 7 days are printed.

The diagram illustrates the navigation steps:

- Special Program** menu (09:54) with options: Regenerating, LT-Cooking, Cook & Hold, ΔT-Cooking, Baking. A **Special** button is at the bottom.
- HACCP** menu (14:33) showing a list of days from Sa 03.08.2002 to Sa 10.08.2002. **Mo 05.08.2002** is highlighted in yellow. Buttons: Menu back, Print, Print 7.
- HACCP** menu (14:42) showing program details for the selected day: 15:00 003 Chicken, 14:00 000 Broccoli. Buttons: Menu back, Print.
- HACCP** menu (15:33) showing the printed record for the selected day. Buttons: Menu back, Print, Print 7.

Printed record example

Serial No.	0
Model	Joker T
Printing date	15.12.07 08:00
Operating hours	0
CT every	3 minutes

Date	Fr 04.07.03 08:49...10:11
Program:	15 Roast veal
08:49	1 Nominal 99°C Humidity 100%
08:59	1 00:10 h Holding time 00:10 h
09:00	2 Nominal 140°C CT 72°C Humidity 60%
09:01	2 CT°C: 16 19 21 24 27 30
09:23	2 CT°C: 33 37 40 43 47 50
09:41	2 CT°C: 53 57 60 63 68 72
09:59	2 00:59 h Holding time 00:59 h
10:00	3 Nominal 180°C Humidity 10%
10:10	3 00:10 h Holding time 00:10 h
10:11	End
Total energy consumption	5,60 kWh
Water consumption	0,00 l

- Serial number
- Unit Type
- Print date of protocol
- Total operating hours of the appliance
- Program date start and end
- Program name
- Nominal time, set time and humidity degree in percent
- Program start
- Hold time, i. e. period the set temperature was held
- Recording of core temperature in a set 3 min.-cycle, resp. 10 min cycle
- Nominal time, set time and humidity degree in percent
- Hold time, i. e. period the set temperature was held
- Program End
- Energy consumption
- Water consumption



For combi cooking, there are no explicit logs for KT values starting with the time of selecting Fct. Combi cooking.

11 Special programs

11.1 Weekly program

- Use the function weekly program for stored programs that are supposed to be started at a certain day and time of the week.

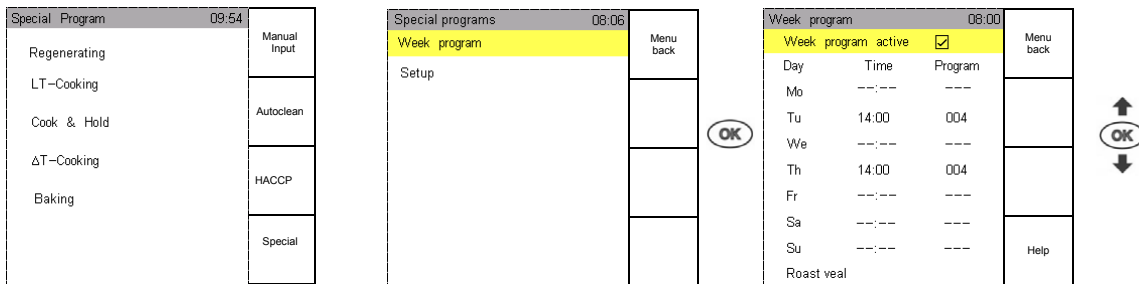

- Touch sensor key **Special Program**, **Special** and confirm **Week program** with **OK**.
- Use Joker Scout arrows \downarrow to select the day of the week and \Rightarrow to set the desired start time of the selected program.
- Confirm with **OK**. The appliance will start at the set day and time with the desired program.
- Press sensor key **Menu back** to return to "Manual Input".

11.2 Setup

11.2.1 Time/Date

- The correct date and time is set when the combi steamer is delivered. However, it may be necessary to change date and time.
- Touch sensor key **Special program**, **Special** and confirm "Setup" with **OK**.
- Confirm Time/Date with **OK**. Use Joker Scout arrows \uparrow or \downarrow to change time and/or date. Confirm with **OK**.
- The screen Time/Date offers further possibilities to change data, for instance summer time or the way of indicating time and date. Use Joker Scout arrows \uparrow or \downarrow to select whatever you like, it is marked.
- And confirm setting with **OK**.

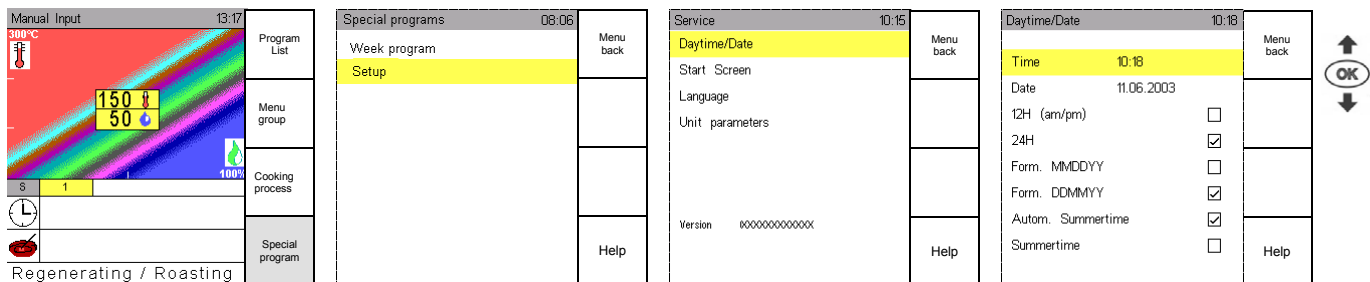

11.2.2 Start Sreen

- You can select 5 different start-up displays.

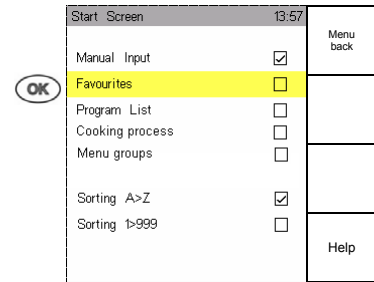
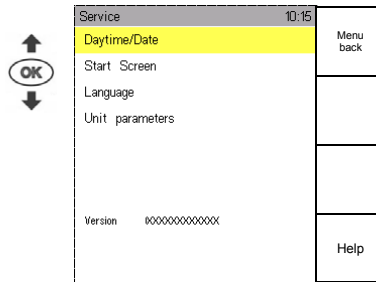

- Select or deselect with "✓" by pressing **OK**.
Screen Manual input, see Sec. 3., is not displayed.

10.2.3 Language

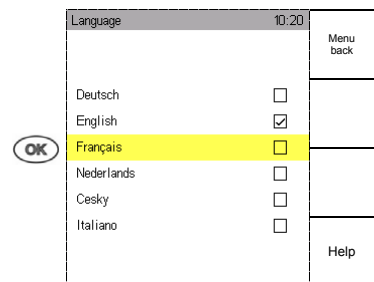
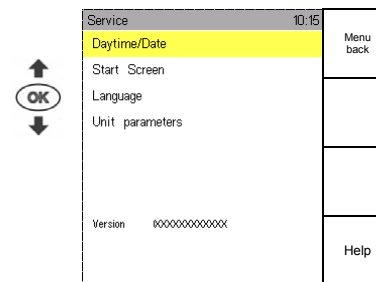

- All functions, menus and information can be displayed in different languages.
- Use Joker Scout arrows \uparrow or \downarrow and confirm whatever language you like with **OK**, it is then marked „✓“.

11.2.4 Unit parameters

- Use Joker Scout arrows and select **Unit parameters**. Activate, deactivate or change other functions.
- Confirm functions to be on or off with **OK**, a selected function is marked „✓“

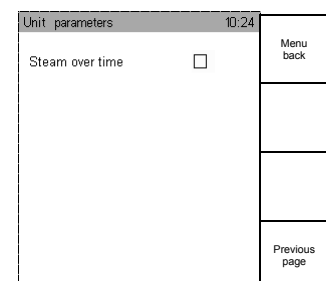
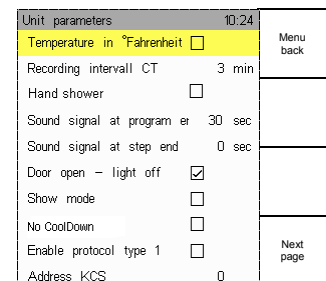
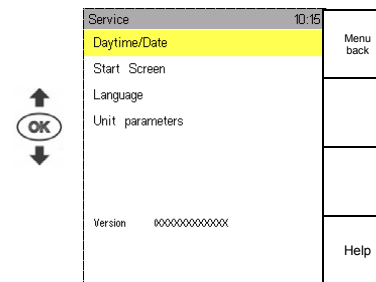

12 Cleaning the cooking chamber

12.1 Automatic self cleaning Autoclean

Programm Info

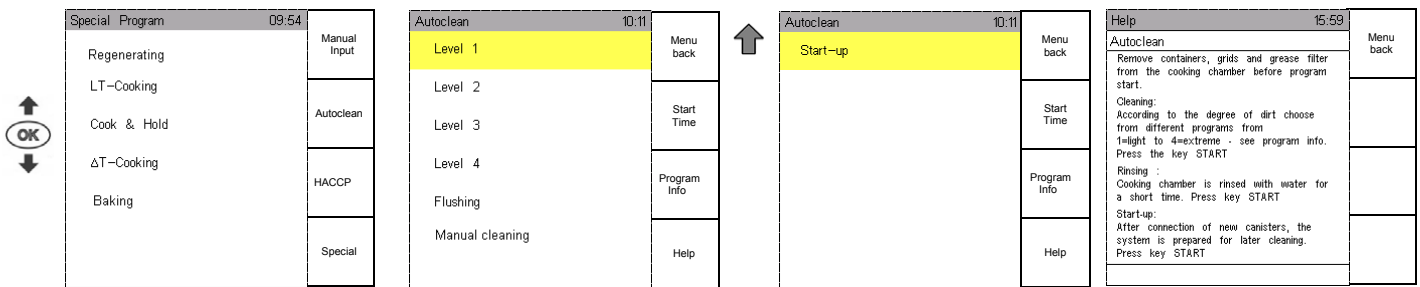

- Prior to starting autoclean, make sure that enough cleaning products are available – visual control.
- Touch sensor key **Special Program**.
- Select autoclean with the sensor key.
- Use the Joker Scout arrows \uparrow or \downarrow to select the desired autoclean cleaning step and start with .
- By pressing key **Program Info** a list appears, explaining details of the different cleaning steps.
- Start up can be reached via the directional arrow \uparrow .

Autoclean programs:

According to the degree of dirt inside the cooking chamber, different programs can be chosen.

Display	Duration	Program steps
Step 1	45 minutes	Soak - 1 x Clean - Rinse – Dry
Step 2	1 hour 15 min.	Soak – 2 x Clean – Rinse – Dry
Step 3	1 hour 45 min.	Soak – 3 x Clean – Rinse – Dry
Step 4	2 hours 15 min.	Soak – 4 x Clean – Rinse – Dry
Flushing	approx. 2 min.	Quick flushing with clear water
Start up	approx. 2 min.	Filling of the tubes
Manual cleaning		

- Whenever the cooking chamber temperature is too high, the cool-down function starts automatically and cools the appliance down to 80° C. The display indicates “Unit cooling-down”.
- Once the temperature is reached, the appliance starts autoclean automatically.
- A manual cool down with open door is not necessary.

12.2 Delay start of autoclean

- It is possible to have the cleaning started automatically within a period of up to 24 hours. Select autoclean on the screen “Special programs” and press sensor key **Start Time!** Start Time can be pre-programmed. Press Start/Stop.
- The autoclean program is recorded.
- See Sec. 11.2.1 and make sure, the correct date and time is set.





12.3 Selection and printing of recorded autoclean protocols

- Go to the function HACCP Sec. 10.1.
- Select the week day desired by scrolling and confirm with **OK**.
- Select the autoclean program to be printed and press sensor key **Print**.
- Press sensor key **Print 7** to have all protocols of the last seven days printed, including the autoclean programs.

12.4 Manual Cleaning

Special Program	09:54	Manual Input
Regenerating		
LT-Cooking		
Cook & Hold		Autoclean
ΔT-Cooking		
Baking		HACCP
		Special

Autoclean	10:11	Menu back
Level 1		
Level 2		Start Time
Level 3		
Level 4		Program Info
Flushing		
Manual cleaning		Help

- Select **Autoclean** with sensor button.
- Select **manual cleaning** using Scout  and start it with .
- Caution!: manual cleaning begins only at a maximum temperature of max. 60°C/140°F display indicates .
- Any burnt on food is softened.
- When the default values are reached, a signal sounds and the  display flashes.
- Open the appliance door and spray the cooking chamber with a cleaning agent by hand.
- Ajar the appliance door and leave the cleaning agent to work.
- Once the cleaning agent has had time to work, a signal sounds and the  display flashes. Open the door and flush the cooking chamber out thoroughly with water (using the hand shower).
- Ajar the door. The cooking chamber is dried and you should leave its door open afterwards to ensure good ventilation.



Do not spray cleaning agent in a hot oven cavity.

Use the shower only for rinsing the interior but not for outer surfaces.

In case cleaning agent remains in the cooking chamber, this may cause corrosion problems

13. Hints on operational safety



Please do observe carefully the detailed installation instructions. Only approved Eloma cleaning agents may be used.

All safety devices inside the unit have been designed to the use of these products in order to comply with the standard specifications of the drinking water supply.

Other cleaning products can possibly cause irreparable rust damages in the cooking chamber, as well as damage pumps and seals.

Eloma GmbH cannot assume liability for any damages resulting from the use of alternative products. This will void the Eloma warranty.

Regular maintenance on all types of water treatment and compliance with the manufactures recommendations need to be adhered to at all time. Should water treatment and cleaning agents not comply to the Eloma standard this will affect any possible warranty claims.

Do not use flammable liquids for cleaning the appliance.

Exchange of canisters and refilling of cleaner and rinse agent.

Observe the directions of the manufacturer and wear suitable protective clothing, gloves and glasses.



For safety reasons, the door must not be opened during an autoclean program.

Cleaner, rinse agent, hot water and steam may escape. If it is absolutely necessary to open the door, the autoclean program must be stopped.

If the oven is not used for an extended period of time, rinse the whole Autoclean system thoroughly with lukewarm water to avoid clogging caused by cleaner and rinse-agent remainders.

Remove screwings from the canisters and clean the tube ends and the filter in warm water. Start autoclean step **Flushing** and rinse the appliance until no more cleaner is remaining inside the tubes and the cabinet.



Preparation for cleaning

Prior to starting a cleaning program make sure that there is sufficient cleaner and rinse agent in the respective canisters. **Visual control.**

No food products should be in the cooking chamber.

Exchange of canisters

In case there is not sufficient cleaner or rinse agent left, the canisters must be exchanged or refilled. Please ensure that correct connections are made.

- Select autoclean with the sensor key **Special Programme**, and confirm with **OK**.
- Use the Scout arrow keys ↑ and ↓ to select operation and start with .
- Autoclean is ready for use.

14. Communication ProConnect ↔ Combi steamer

14.1 Start up communication ProConnect ↔ Combi steamer Genius compact, Joker T

- Use the appropriate cable to establish a communicating connection between PC and combi steamer, "Point-to-Point" connection RS 232.
- Plug the connecting cable to external SubD9 port in the hose shower tulip and connect the other end to the PC.

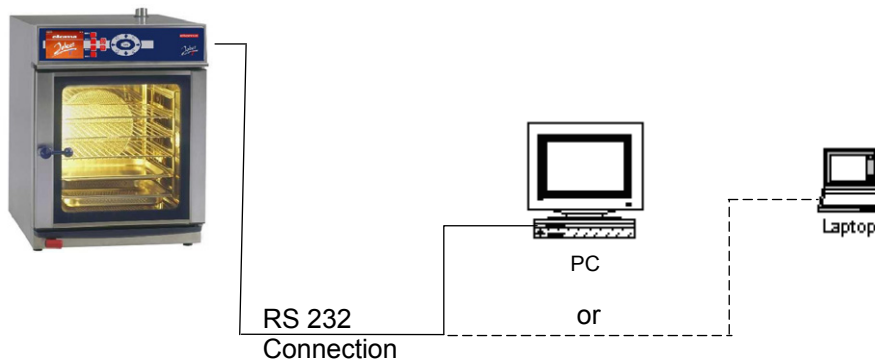

- The combi steamer is in standby mode, it may be necessary to switch off the combi steamer.
- The PC is switched on and ProConnect is started
- Set the device address of the combi steamer in the PCPrg:
Menue/Options/device address.
- Set Com-Port in the PCPrg to the one used as interface for the connection
PCPrg ↔ Combi steamer.
- Provided the connection is established via USB-Port of the PC and USB/RS 232 adapter, this interface is also indicated as Com-Port on the PC.
- It is possible to test the communication in the set-up dialog for device address and port, "check communication".
- Of course, there are further individual possibilities for connection and connectivity via RS 485 systems.
- Contact our Service Hotline or our sales department for further information.





14.2. Connection to Kitchen control systems (KCS)

In case special hard/software is available, a connection to kitchen control systems is possible.

15. Error

15.1 Error display

- Press sensor key **Help** to get valuable information regarding failures.
- The displayed symbols explain possible failure causes and offer remedies.
- If your Joker does not work correctly, take the following list and try to help yourself. If you do not succeed, switch off and disconnect the unit from the mains. **Call the after-sales service.**
- Press sensor key **menu back** to return to the previous screen immediately.
- After a certain period of time this is also done automatically.

FAILURE Symbols	Possible cause	Remedy
	No operation is possible, the door is open.	Shut the door
	Open the water tap. The water flow pressure must be checked, 2 bar / 29 PSI for soft water. Check the water pressure switch. Autoclean will pause until pressure is high enough.	Reset: Autonomous when repaired.
	Not enough water Is the appliance connected to water? Check if water tap is open. Control the <i>flow</i> water pressure Adjust the solenoid valve to the correct amount of water.	Soft water on
	Miscellaneous defects Operation possible	Only After-sales service! This symbol remains displayed until the after-sales service has confirmed that the repair has been done.
	This symbol remains displayed until the correct temperature for the autoclean function is reached.	No action is required!



In case the meat probe is broken, the appliance can be used in a limited way.
A running program can be finished without core temperature control.
Attention: visual/manual control!

Any further programs can only be performed without core temperature control, if not repaired.

15.2 Error Message

Error	Description	Reaction, error remedy
111	Probe cooking chamber 1 no signal	Operation stop! Customer service call!
113	Meat probe no signal sensor 1	Warning! Customer service call! Meat probe operation is possible!.
114	Meat probe no signal sensor 2	Warning! Customer service call! Meat probe operation is possible!
115	Meat probe no signal sensor 3	Warning! Meat probe operation is possible! Customer service call!
116	Meat probe no signal sensor 4	Warning! Meat probe operation is possible! Customer service call!
117	Water vapour elimination sensor, no signal	Operation with a defective sensor is possible! Customer service call!
127	Water vapour elimination sensor, no signal	Operation with a defective sensor is possible! Customer service call!
212	Over temperature STB cooking chamber or motor safety MI released	Operation stop! Customer service call!
311	No water pressure	Cooking operation: Warning / autoclean: Pause Open water valve. Remedy too low customer-side water pressure. Check the pressure switch for proper functioning. Attention! The appliance pauses in autoclean! The appliance can be used without water in cookingoperation!
313	Hand shower off	Activate Hand shower in the Service
511	Control module	Warning! PCB temperature above 65°C Operation possible, Customer service call!
512	Control module	Operation stop! PCB temperature above 70°C Customer service call!

15.3 Trouble Shooting

If your Joker isn't working properly, review the following list first.

If you do not succeed, switch off, disconnect from mains, close water tap.

Call the after-sales service

Failure	Possible Cause	Remedy
No required heating capacity, fan does not start	External main switch is turned off	Turn the main switch on.
	Fuse has tripped	Check the fuses in the building's distribution system.
	The ambient temperature of the appliance was below +4°C for a prolonged period of time	Heat the cooking chamber to above 20°C. The appliance may only be operated in frost-proof areas.
No steam generation	Water tap closed	Open water tap
Water in the cooking chamber does not run off	Drain clogged	Remove drain-sieve and clean it, flush the drain
Calcareous deposits on inner panels	Water too hard. Water-softener exhausted	Connect the oven to a water-softener Regenerate water softener
Formation of rust in the cooking chamber	Poor water quality	Filter the water, follow the installation instructions
	Wrong cleaning agent	Use recommended cleaner agents
	Incorrect cleaning agent	Use Eloma cleaning agents.
Steam escapes from door	Door sealing exhausted, not enough contact pressure to the oven	Readjust the door latch
	Door sealing defect	Call the after-sales service

15.4 Turn off the combi steamer



Switch off by pressing **ON/OFF key**. The LED in the key extinguishes.

Close **water tap**.

Disconnect the appliance from the mains, if it is not used for a longer period of time.

16. Cleaning and maintenance

Regular cleaning of the combi steamer is of utmost importance.
Only Eloma recommended cleaner agents may be used.
Please observe the manufacturer's operating instructions.

Caring for the door sealing

A door sealing is subject to wear.

Proper care of sealing prolongs service life.

- Grease and caustic cleaning agents attack and weaken the sealing material and thereby accelerate the rate of wear.
- Chicken and pork grease are very aggressive. Please observe the following care instructions:
- Manually clean the sealing daily with a mild grease solvent.
- Use fresh water to remove any remaining cleaning agent.
- Leave the door open overnight to allow the door sealing to relax.
The door should also be left open when the appliance is not in use.
- Inspect the sealing regularly for damage.
Replace damaged sealing to prevent steam/air from escaping.
- The sealing of appliances with autoclean cleaning systems must also be cleaned by hand.
Grease and cleaner deposits often collect on the outer side of the sealing. If these are not removed, the sealing decomposes at those places.

Cleaning of glass panel:

Clean only with a soft cloth. Never use scouring agents.

Cleaning of door glasses:

The door is made of two parts. The inner glass can be opened for cleaning. Clean only with a soft cloth. Never use scouring agents.



Cleaning of outer surfaces:

Use fat/grease dissolving cleaning agents or special stainless steel cleaners.

Cleaning of the grease/fat filter:

Cleaning the grease/fat filter should be daily routine.

If heavily contaminated we recommend a cleaning bath or cleaning in a dishwasher.

We strongly recommend to work with 2 filters, so that one filter can be immersed in a cleaning bath or dishwasher, while using the other one. Always rinse it thoroughly with fresh water.

Cleaning of drip trays:

Clean both drip trays, the one on the door and the one underneath, at least weekly, respectively when necessary.

Cleaning the cooking chamber behind the air conducting sheet :

Clean weekly respectively according to contamination.

Switch off the appliance and allow to cool down.

Remove the grease/fat filter.

Remove the hang-in racks.

Remove the fixing screws of the air conducting sheet.

Remove the air conducting sheet.

Clean the drain filter.

Clean the now accessible interior thoroughly.

After cleaning replace all parts removed in reverse order.

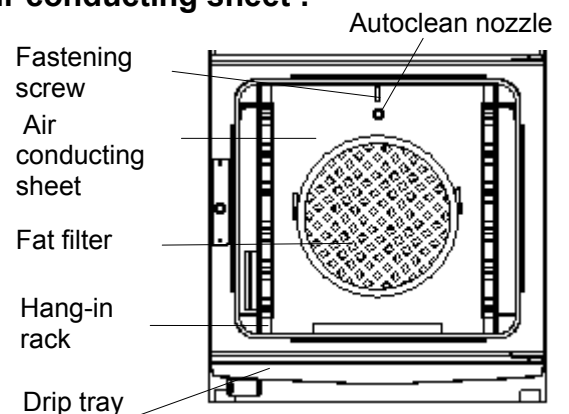

It is not allowed to operate the oven without air conducting sheet!

Do not use either water jet, high pressure sprayer or steam purifier on outer surfaces.

Water jets may damage parts of the appliance or else get in contact with electric live parts.

DANGER – personal injury caused by an electric shock. Do not spray into a hot oven cavity.



After the end of the cleaning program, and if the unit is not in use open the door to allow adequate ventilation of the cooking chamber.

EG-Konformitätserklärung / EC Declaration of Conformity

Hersteller / Manufacturer

Eloma GmbH
Innovative Koch und Backtechnik
Otto-Hahn-Straße 10

D-82216 Maisach

Produktbezeichnung / Product name: Großküchen- Heißluftdämpfer / Combi steamer for commercial use

Geräte / Appliances:

Joker B 6-23; Joker T 6-23;
Multimax A 6-11; Multimax A 10-11; Multimax A 20-11;
Multimax B 6-11; Multimax B 10-11; Multimax B 20-11;
Multimax B 12-21; Multimax 20-21;
Genius T 6-11; Genius T 10-11; Genius T 20-11;
Genius T 12-21; Genius T 20-21

Erfüllte Richtlinien / Guidelines satisfied:

Der Hersteller erklärt, dass die oben genannten, von ihm hergestellten Heißluftdämpfer den folgenden Richtlinien und Normen entsprechen.
The manufacturer hereby declares that his combi steamers, as listed above, comply with the following directive standards.

Maschinenrichtlinie 2006/42/EG / Machinery Directive 2006/42/EG Elektromagnetische Verträglichkeit 2004/108/EG / EMC 2004/108/EG

Die Schutzziele der Niederspannungsrichtlinie 2006/95/EG werden gemäß Anhang I, Nr. 1.5.1 der Maschinenrichtlinie eingehalten.

The protection goals of Low Voltage Directive 2006/95/EC comply with Annex I, Nr. 1.5.1 of the Machinery Directive.

Angewandte Normen / Applicable standards

Die Geräte erfüllen die Sicherheitsanforderungen der folgenden europäischen Normen:
The appliance are in compliance with the safety requirements of the following European standards:

EN ISO 12100-1:2003 + A1:2009
EN ISO 12100-2:2003 + A1:2009
EN ISO 14121-1:2007
EN 60335-2-42:2003 + A1:2008
EN 60335-1:2002 + A11:2004 + A1:2004 + A12:2006 + A2:2006 + A13:2008
EN 55014-1:2006; EN 61000-3-2:2006; EN 61000-3-3:2006; EN 55014-2:2002

Qualitätsmanagement / Quality management:

Die Konformitätserklärung erlischt bei nicht verwendungsgemäßer Benutzung sowie bei konstruktiver Veränderung, die nicht von uns als Hersteller schriftlich bestätigt wurde.

The declaration will become invalid by inappropriate usage as well as changes in construction were not confirmed in writing by us as a manufacturer.

Die Eloma GmbH wendet ein zertifiziertes Qualitätsmanagement- System nach EN ISO 9001 an.
Eloma GmbH applies a certified quality management system in accordance with EN ISO 9001.

Dokumentationsbeauftragter / Person authorized to compile the technical file:
Hans Hommen Technische Dokumentation Eloma GmbH

Maisach, den 1.01.2010

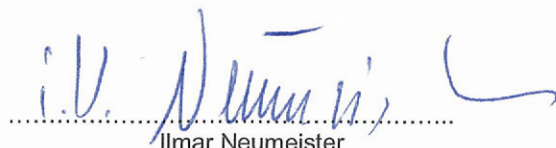

.....
Ilmar Neumeister

Geschäftsleitung Produktentwicklung / Executive Board Engineering

Englisch
Art. Nr.: bed_501283_jtgc_1v3_en_usa