

A	SAFETY INSTRUCTIONS	Pag.	4
B	GENERAL RECOMMENDATIONS	Pag.	5
B1	HANDLING	Pag.	5
B2	UNPACKING	Pag.	5
B3	DISPOSAL OF PACKING MATERIAL.....	Pag.	6
B4	TECHNICAL DATA.....	Pag.	7
C	INSTALLATION AND START-UP INSTRUCTIONS	Pag.	10
C1	WATER CONNECTION.....	Pag.	10
C2	ELECTRICAL CONNECTION	Pag.	10
C3	WARNING MESSAGES DISPLAYED ON THE CONTROL PANEL.....	Pag.	11
C4	DETERGENT/RINSE-AID DISPENSERS AND SETTINGS.....	Pag.	12
C5	SETTING THE DISPENSERS.....	Pag.	13
D	USER INSTRUCTIONS.....	Pag.	15
D1	STARTING.....	Pag.	15
D2	WASH CYCLES.....	Pag.	16
D3	OPERATION.....	Pag.	16
D4	END OF WORK AND DAILY CLEANING.....	Pag.	17
D5	MAINTENANCE.....	Pag.	18
D6	UNDERCOUNTER DISHWASHER WITH INCORPORATED CONTINUOUS WATER SOFTENER.....	Pag.	19
E	TROUBLESHOOTING.....	Pag.	21

A

SAFETY INSTRUCTIONS

To reduce the risk of fire, electrical shock, or injury when using your dishwasher, please follow these basic precautions including the following:

- Read all instructions before using your dishwasher.
- This Manual does not cover every possible condition and situation that may occur. Use common sense and caution when installing, operating and maintaining this appliance.
- Do not sit, stand or lean on the door or racks of a dishwasher.
- Store dishwasher detergent and rinse agents in clearly marked packages with MSDS (Material Safety Data Sheets) sheets in a safe place.
- **FOR YOUR SAFETY DO NOT STORE OR USE GASOLINE OR OTHER FLAMMABLE VAPORS AND LIQUID IN THE VICINITY OF THIS OR ANY OTHER APPLIANCE.**
- Your dishwasher uses hot water to clean and sanitize a variety of wares. Machine surfaces and wares become hot during and immediately following normal operations. Operators should use caution when loading and unloading wares from the machine.
- Do not touch the heating element during or immediately after use.
- The installation of this unit must conform to local codes or, in the absence of local codes, to all National Codes governing plumbing, sanitation, safety and good trade practices.
- **BEFORE SERVICING, DISCONNECT THE ELECTRICAL SERVICE AND PLACE A RED TAG AT THE DISCONNECT SWITCH TO INDICATE WORK IS BEING DONE ON THAT CIRCUIT.**
- **NOTICE:** CONTACT YOUR AUTHORIZED SERVICE COMPANY TO PERFORM MAINTENANCE AND REPAIRS.
- **NOTICE:** Using any parts other than genuine factory manufactured parts relieves the manufacturer of all warranty and liability.
- **NOTICE:** Manufacturer reserves the right to change specifications at any time without notice.
- **WARNING:** The equipment warranty is not valid unless the appliance is installed, started and demonstrated under the supervision of a factory trained installer.
- **WARNING:** The unit must be installed by Personnel who are qualified to work with electricity and plumbing. Improper installation can cause injury to personnel and/or damage to the equipment. The unit must be installed in accordance with applicable codes.

SAVE THESE INSTRUCTIONS

B GENERAL RECOMMENDATIONS

WARNING

CAREFULLY READ THE INSTALLATION OPERATING AND MAINTENANCE INSTRUCTIONS BEFORE INSTALLING THIS APPLIANCE. INCORRECT INSTALLATION, ADAPTATIONS OR ALTERNATIONS COULD CAUSE DAMAGE TO PROPERTY OR PERSONAL INJURY. FAILURE TO COMPLY WITH THESE INSTRUCTIONS, ABUSE RESULTING IN DAMAGE AND IMPROPER INSTALLATION WILL VOID WARRANTY AND RESPONSIBILITIES OF THE MANUFACTURER.

- Carefully read this instructions booklet, as it contains important advice for safe installation, operation and maintenance. Keep this booklet handy in a safe place for future reference.
- The installation instructions contained herein are for the use of qualified installation and service personnel only. Installation or service by other than qualified personnel may result in damage to the appliance and/or injury to the operator. FAILURE TO COMPLY WITH INSTALLATION INSTRUCTION OR IMPROPER INSTALLATION WILL VOID WARRANTY AND RESPONSIBILITIES OF THE MANUFACTURE.**
- The equipment warranty is not valid unless the unit is installed, started and demonstrated under the supervision of a factory trained installer.
- Switch off the appliance in the event of failure or malfunctioning at the main circuit breaker.

Only have the appliance repaired by an Authorized Service Center and be sure to ask for OEM original spare parts.

NOTICE FOR SHIPPING DAMAGE

- The container should be examined for damage before and during unloading.
- The freight carrier has assumed responsibility for its safe transit and delivery.
- If damaged equipment is received, either apparent or concealed, a claim must be made with the delivering carrier. Apparent damage or loss must be noted on the freight bill at the time of delivery.
- The freight bill must then be signed by the carrier representative (Driver). If the bill is not signed, the carrier may refuse the claim. The supply can supply the necessary forms.
- A request for inspection must be made to the carrier within 15 days if there is concealed damage or loss that is not apparent until after the equipment is uncrated.
- The carrier should arrange an inspection.
- Be certain to hold all contents plus all packing material. Under no circumstances should a damaged appliance be returned to the manufacturer without prior notice and written authorization.

B1 HANDLING

Use suitable means to move the appliance: a lift truck or fork pallet trucks (the forks should reach more than halfway beneath the appliance).

B2 UNPACKING

Wear protective gloves to unpack.

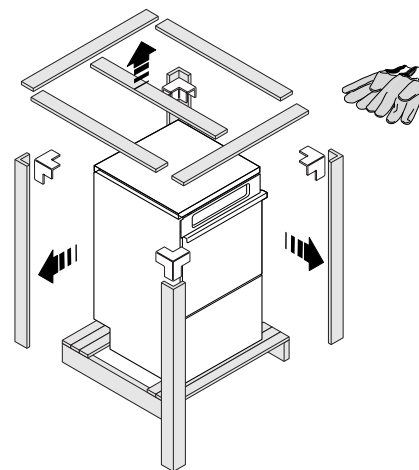

Figure 1

Lift the appliance using a lift truck,

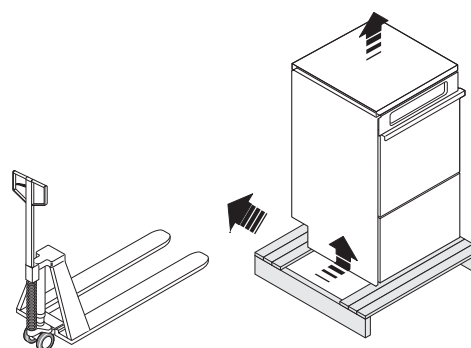

Figure 2

remove the base and position the appliance where it is to be installed.

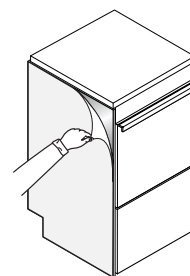





Figure 3

Remove the protective film and ensure that the packaging material is disposed of correctly in compliance with

the regulations in force in the country where the product is to be used.

B3 DISPOSAL OF PACKING MATERIAL

All the packaging materials are environmentally safe and friendly. They may be kept without fear or danger. They may be recycled or burned in a special waste incineration plant. Recyclable plastic components are marked as follows:

	polyethylene	external wrapping film, instruction bag.
	polypropylene	top packaging panels, straps.
	polystyrene foam	protective surround elements.

Wood and cardboard components may be disposed of according to local regulations in force. Appliances that have reached the end of their service life should be suitably disposed of. The appliance should be dismantled according to regulations in force. All metal parts are in stainless steel (AISI 304) and are removable. Plastic parts are marked with the symbol of the material.

B4 TECHNICAL DATA

MODEL	LS6AH / WT30H	LS6AH / WT30H
Supply voltage:	208V, 1ph, 60Hz 33amp	240V, 1ph, 60Hz, 29amp
field upgrade to	208V, 3ph 60Hz 20amp	240V, 3ph, 60Hz, 18amp
Total Watts	6.85 kW	6.85 kW
Boiler heating elements	6.0 kW	6.0 kW
Tank heating elements	2.2 kW	2.2 kW
Water supply pressure	7.25 - 101psi/50 - 700kPa	7.25 - 101psi/50 - 700kPa
Water supply temperature	122°F/50°C	122°F/50°C
Water supply hardness	140ppm/14°FH max	140ppm/14°FH max
Rinse cycle water consumption	1 gallon/3.8 liters	1 gallon/3.8 liters
Boiler capacity	3 gallons/12 liters	3 gallons/12 liters
Tank capacity	6 gallons/23 liters	6 gallons/23 liters
Standard cycle time with water supply at 122°F/50°C	120/180/240 seconds	120/180/240 seconds
Legal noise level Leq	<65dB	<65dB
Minimum Supply - Circuit Ampacity	34amp	30amp
Net weight	150lb/68kg	150lb/68kg
Shipping weight	181lb/82kg	181lb/82kg
Shipping width	27 15/16" / 710 mm	27 15/16" / 710 mm
Shipping height	41 3/4" / 1060 mm	41 3/4" / 1060 mm
Shipping depth	30 11/16" / 780 mm	30 11/16" / 780 mm

Table 1

Standard cycle time may vary should the inlet water temperature be different from that indicated above.

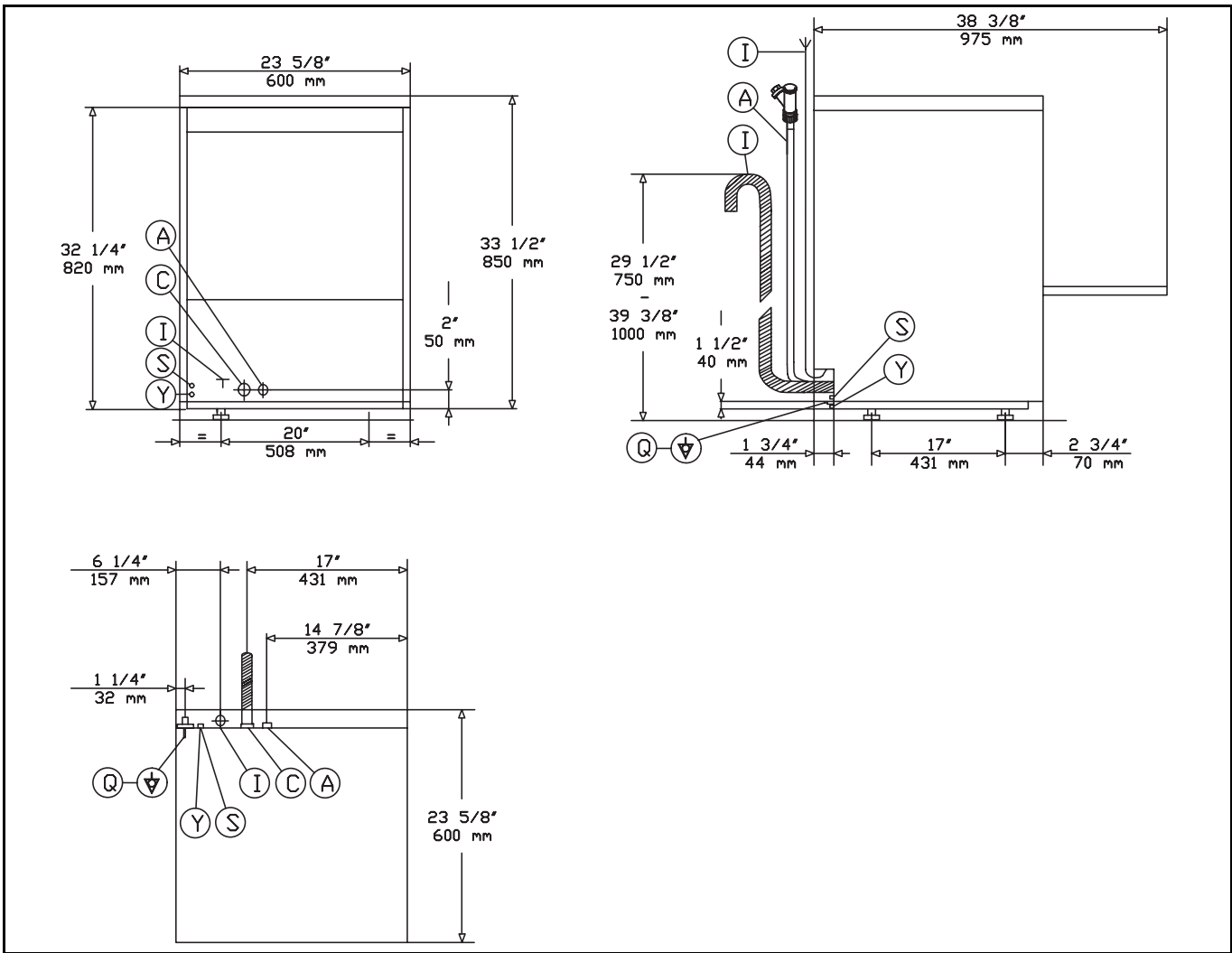

Figure 4

Legend Figure 4

- A** - Water inlet pipe with $\frac{3}{4}''$ dia/19mm fittings
- C** - Outlet pipe $1 \frac{5}{8}''$ ID /40 mm (^) – $1 \frac{1}{16}''$ ID /18 mm (*).
- I** - Power supply
- S** - Detergent connection
- Q** - Equipotential (Ground) screw
- Y** - Rinse aid connection
- (^) - Only for model with free-fall drainage
- (*) - Only for model with drain pump

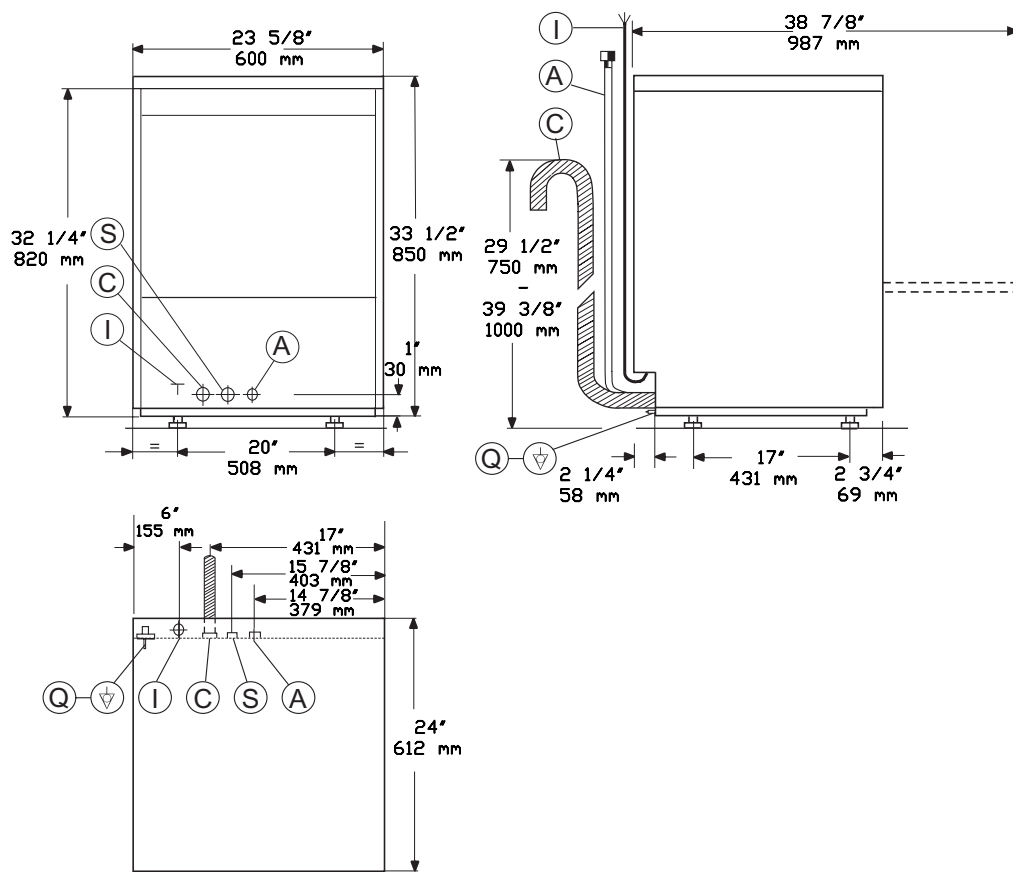

Figure 5 Installation diagram for models with incorporated continuous water softener

Legend Figure 5

- A - Water inlet pipe with \varnothing 3/4" G fittings
- C - Outlet pipe \varnothing 40 mm (^) – \varnothing 20 mm (*).
- I - Power supply
- (*) - Only for model with drain pump

- S - Pipe inlet for detergents
- Q - Unipotential screw
- (^) - Only for model with free-fall drainage

C INSTALLATION AND START-UP INSTRUCTIONS

A fused disconnect switch or a main circuit breaker (customer furnished) **MUST** be installed in the electric supply line for the appliance. It is recommended that this switch/circuit breaker have **lockout/tagout capability**. Before making any electrical connections to this appliance, check that the power supply is adequate for the voltage, amperage, and phase requirements on the rating plate.

RATING PLATE

The rating plate contains identification and technical data and is located on the right-hand side panel of the appliance (Figure 6).

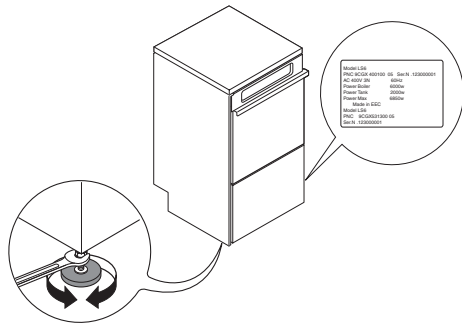

Figure 6

C1 WATER CONNECTION

- Position the dishwasher and level the appliance by adjusting the appropriate bullet feet (Figure 6).
- Connect the appliance water supply pipe “A” (Figure 4) (keeping with local plumbing codes) to the incoming water supply. Install a shutoff valve, Y-Strainer, and a pressure gauge between the appliance and the incoming water supply of the unit (Figure 7).

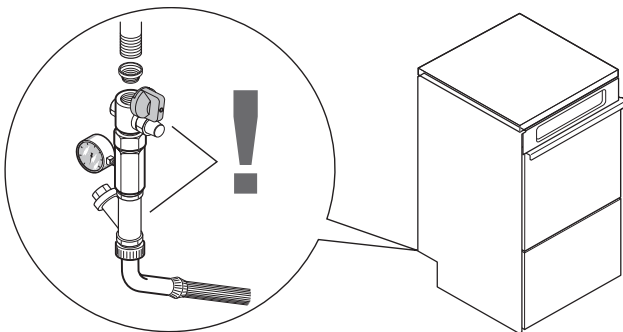

Figure 7

- Check that the **dynamic** water supply **pressure** measures **between 7.25 - 101 psi/50 - 700kPa** while dishwasher tank or boiler is filling with water.

If the pressure is too high, install a suitable pressure regulator on the incoming water supply to the unit.

Position the outlet pipe at a height anywhere between 29 1/2” to 39 3/8”/750 to 1000mm from the floor.

Check that about 1 gallon/4 litres of water flow out of the outlet pipe during the rinse cycle.

Make sure drain hose does not kink, pinch or twist, resulting in a water flow restriction.

C2 ELECTRICAL CONNECTION

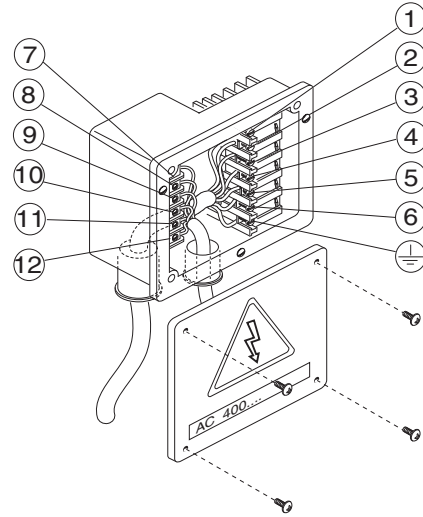

Figure 8



CAUTION
THE ELECTRICAL CONNECTIONS MUST MEET ALL NATIONAL AND ELECTRICAL CODE REQUIREMENTS.

The installation of this unit must conform to local codes or, in the absence of local codes, to all National Codes governing plumbing, sanitation, safety and good trade practices.

- Check the over rating plate before making any electric supply connections. Electric supply connections must agree with data on the unit rating plate.
- The earth wire at the terminal end must be 3/4”/20mm (max.) longer than the phase wires.
- The appliance requires a ground connection to the unit ground screw located at the rear of the unit marked “Q” (Figure 4) in the manual and marked with the symbol “⚡” on the unit. The ground wire must have a cross section of AWG 8/8.35 mm². Do not use the wiring conduit or other piping for ground connections. If necessary, have the electrician supply the ground wire.



WARNING

Before servicing unit switch off power at the main circuit breaker and place a red tag on the breaker to indicate work is being done on that circuit.

Power supply 208 V 1ph or 240 V 1ph

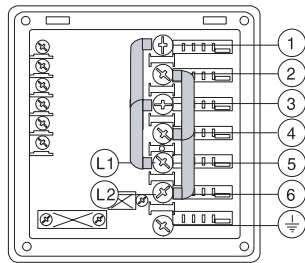

Figure 9

Open the power supply terminal box and insert the jumpers provided as follows: two jumpers between terminals 1, 3, 5 and another two between terminals 2, 4 and 6.

Using a suitable power supply cable connect L1 and L2 to terminals 5 and 6 respectively and the ground wire to the terminal \perp .

Power supply 208 V 3ph or 240 V 3ph

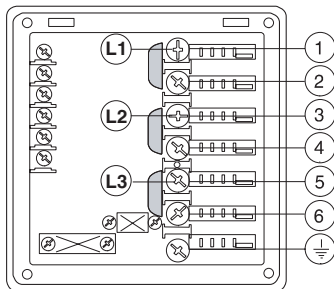

Figure 10

Open the power supply terminal box and insert the jumpers provided as follows: one jumper between terminals 1 and 2, one between terminals 3 and 4 and another between terminals 5 and 6. Using a suitable power supply cable, connect the three phases to terminals 1, 3, 5, and the earth wire to the terminal \perp .

Connections provided for energy control

This appliance is designed for an external energy consumption control.

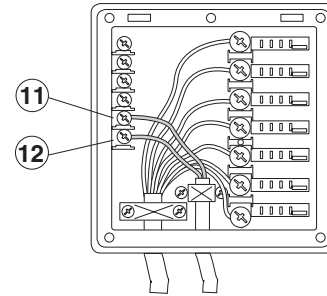

Figure 11

Connect the energy peak controller across terminals 11 and 12.



CAUTION

A normally open (n.o.) contact of the controller must be connected across terminals 11 and 12. When this contact closes the boiler heating elements are disconnected. Using the dishwasher in these conditions may increase the cycle time.

Safety devices

- An automatic resettable thermally protected device incorporated in the windings of the electric pump cuts off the electricity supply in the case of malfunctioning.
- In the event of water mains failure, a back-flow device prevents water in the boiler from returning into the mains.
- An overflow pipe, connected to the drainage outlet, maintains the water in the tank at a constant level.
- On models with a drain pump, a supplementary level control device activates if the main level control device is faulty.

Failure to comply with safety rules and regulations relieves the manufacturer of all liability.

C3 WARNING MESSAGES DISPLAYED ON THE CONTROL PANEL

A1 NO WATER

- Check that the shutoff valve is open.
- Check that the water inlet filter is clean.
- Check the minimum main pressure is not less than 7.25 psi/50kPa.
- Check that the overflow pipe is inserted (for appliances without drain pump only).

B1 INSUFFICIENT DRAINAGE

- Check if the overflow has been removed.

- Check for obstruction on the waste outlet pipe and the overflow aperture.

B2 TANK WATER LEVEL TOO HIGH

- Check for obstruction on the waste outlet pipe and the overflow aperture.

C1..C8 CALL THE AUTHORIZED SERVICE CENTER

E1..E8 CALL THE AUTHORIZED SERVICE CENTER

- The appliance continues to operate, but appropriate checks by an authorized technician are recommended.

C4 DETERGENT/RINSE-AID DISPENSERS AND SETTINGS

If the appliance is connected to a water softener or osmotic device, contact the detergent supplier for the specific product.

Peristaltic dispensers (rinse-aid and detergent) require periodic maintenance. The internal hose of the rinse-aid dispenser should undergo periodic maintenance (at least once or twice a year).

1. Dishwasher with incorporated detergent dispenser pump (Figure 12).

Pump “R” dispenses about 0.021oz per second /0.6g per second of detergent. When the appliance is filled with water for the first time in the day, it dispenses 1.058oz/30g of detergent in 50 sec., thereby providing a concentration of 0.046oz per quart/1.3g per liter. Pump “R” dispenses 0.169oz/4.8g in 8 sec. at each cycle.

Dispenser operating time may be changed, following the instructions given in the next paragraph.

Insert the hose provided in the kit into the detergent container.

2. Dishwashers with incorporated peristaltic rinse-aid dispenser pump (Figure 12).

Pump “S” dispenses about 0.0046 oz per second/0.13 g per second of rinse-aid. It dispenses 0.018 oz/0.52 g in 4 sec. at each rinse.

Dispenser operating time may be changed, following the instructions given in the next paragraph.

Insert the hose provided in the kit into the rinse-aid container .

Connections for automatic detergent dispenser (Figure 12)

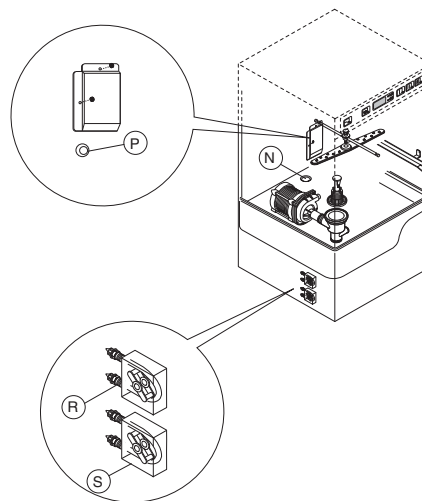

Figure 12

There is a ready-made impression “N” (inside dishwasher chamber floor) to be perforated (5/16”dia/8mm) for positioning the detergent concentration measuring sensor.

Inside the tank there is a hole “P” (3/8”dia/10mm) closed with a plug, which may be used for mounting a liquid detergent injector.

The sensor and liquid detergent injector should be installed without compromising the watertightness of the appliance.

Electrical connections for automatic detergent and rinse-aid dispensers.

Terminals are available on the power supply terminal box for the electrical connection of external dispensers working at 208V or 240V. Max. power 30 VA.

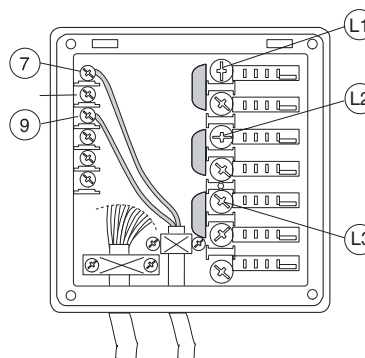

Figure 13

Connect the **detergent dispenser** between terminals 7 and 9. These connection points are live for a set time during filling of the tank and at the start of the wash cycle (see paragraph “Setting the dispensers”).

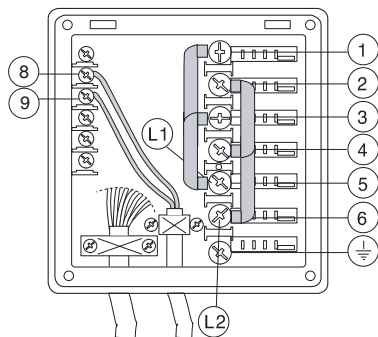

Figure 14

Connect the **rinse-aid dispenser** between terminals 8 and 9. These connection points are live during filling of the tank and at the end of the rinse cycle for a set time (see “setting the dispensers” paragraph).

MANUAL ACTIVATION

Whenever the detergent containers are replaced, it may be necessary to activate the dispensers manually in order to fill the hoses and eliminate any air.

Simultaneously press the buttons, as shown in the figures below. If necessary, repeat this operation several times.

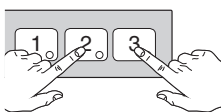

DETERGENT DISPENSER

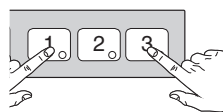

RINSE-AID DISPENSER

C5 SETTING THE DISPENSERS

All operations should be carried out with the appliance switched on, the door open and no cycle selected.

LEGEND



Increase



Decrease



Confirm or select next parameter

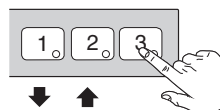

SEQUENTIAL START

Press the indicated buttons simultaneously for 5 seconds:



Display of programming mode:



Initial amount of detergent:



Setting the activation time:

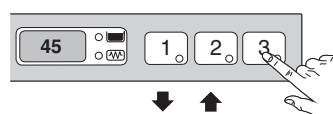

Initial amount of rinse-aid:



Setting the activation time:

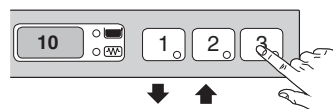

Amount of detergent during the cycle:



Setting the activation time:

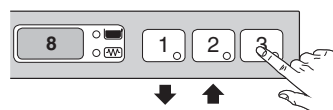

Amount of rinse-aid during the cycle:



Exit from programming mode:

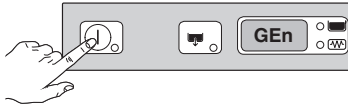

Notes for external dispensers:

- if $dEt = 101$ the **detergent dispenser** only operates during **wash pump** operation; terminals **7 and 9** of the main terminal box are powered at the same time.
- if $dEt = 102$ the **detergent dispenser** only operates during **filling electrovalve** operation for restoring the boiler level; terminals **7 and 9** of the main terminal box are powered at the same time.
- if $rA = 61$ the **rinse-aid dispenser** only operates during **filling electrovalve** operation for restoring the boiler level; terminals **8 and 9** of the main terminal box are powered at the same time.
- if $rA = 62$ the **rinse-aid dispenser** only operates during **wash pump** operation; terminals **8 and 9** of the main terminal box are powered at the same time.

For connections, see the wiring diagram.

Example:

Supposing that an external detergent dispenser has been connected with a tank concentration measuring sensor, a standard setting could be as follows:

$dIn = 0$ the dispenser is not activated during filling of the tank

$dEt = 101$ the dispenser is activated during wash pump operation and, thanks to the concentration measured by the conduction sensor, the correct amount of detergent is dispensed.

Suggestion: to check the effectiveness of the rinse-aid, look at freshly washed glasses against the light. Drops of water remaining on the glass indicate an insufficient amount, while streaks on glass indicate an excess amount.

Changing the detergent/rinse-aid type

If changing to a **different detergent/rinse-aid type** (even one by the same manufacturer), you must rinse the suction and pressure hoses with fresh water before connecting the new detergent/rinse-aid container. Otherwise, the mixing of different types of detergent/rinse-aid will cause crystallisation, which may result in a breakdown of the dosing pump. Failure to observe this condition will invalidate the warranty and product liability.

D USER INSTRUCTIONS

Our appliances have been studied and optimized to give the highest performance. This appliance must be used exclusively for the purpose for which it has been designed, i.e. for washing dishes with water and specific detergents. Any other use will be considered “improper use” and will void the warranty and manufacturer liability.

This appliance will not carry out the rinse cycle should there be no supply water; it stops all functions and an error message “A1” will be displayed (also see “Warning Messages Displayed On The Control Panel”).

TIPS

- Carry out a couple of cycles without dishes to flush out any industrial grease which have remained in the tank and piping.
- Avoid washing decorated dishes.
- Do not allow silverware to come into contact with other metals.
- Do not allow food to dry on the dishes.
- Remove large food scraps from the dishes to prevent clogging the filters.
- Pre-wash the dishes by spraying them with cold or lukewarm water, do not use any detergent.
- Use automatic dispensers for the detergent.
- If there is no automatic dispenser, pour a non-foaming detergent into the tank when the water has reached the washing temperature.

CONTROL PANEL

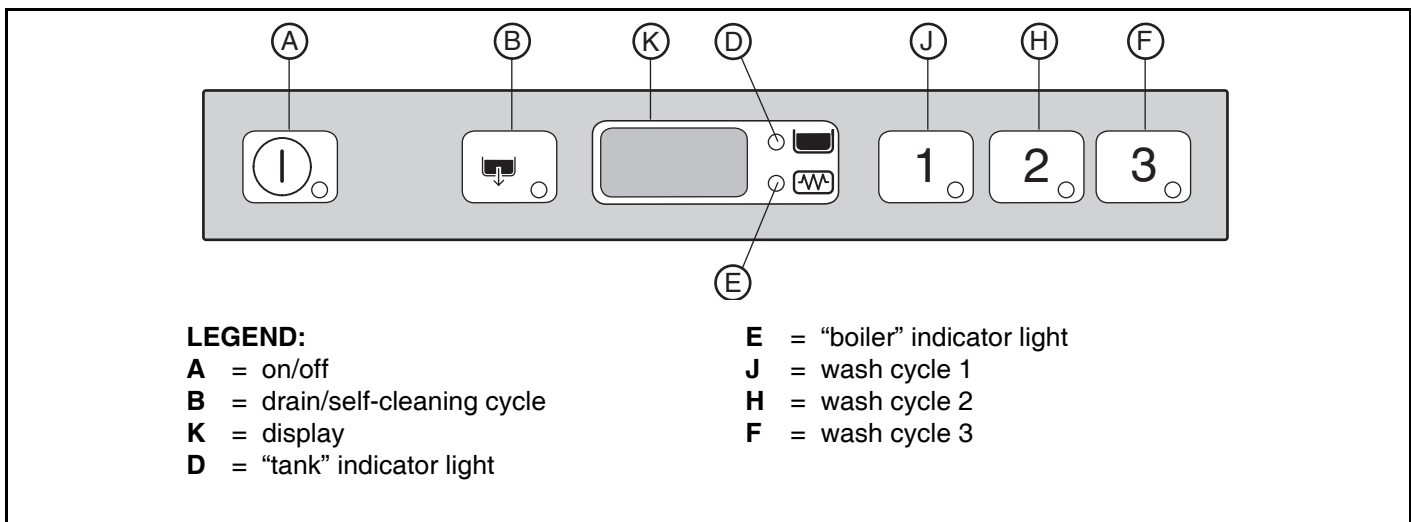
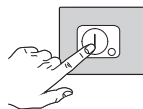

Figure 15

The temperature shown on the display is that of the boiler if the indicator light “E” is on or of the tank if the light “D” is on. The tank temperature is displayed during the wash cycle and the boiler temperature during the rinse cycle.

D1 STARTING

- Open the water supply shutoff valve.
- Switch unit on at the main circuit breaker.
- Open the door and check that all the components are in their correct position.
- Close the door and press on/off “A” button.



The indicator light of the on/off button “A” (Figure 15) comes on, indicating that the dishwasher is powered and that water is being introduced and heated. The word “FILL” is shown on the display during the entire filling and heating stage



Notice, this dishwasher does the first tank filling through several consecutive hot rinse cycles, while the display shows the message FILL (scrolling across display). This

system save up to 30% in time over traditional models. If the door is opened during this stage the message "CLOSE" will scroll on the display:



The filling and heating stage has finished when the display shows the tank temperature:

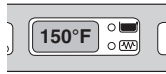

To display the boiler temperature during heating of the tank, open the door and press "J" button (Figure 15).

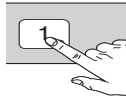

D2 WASH CYCLES

The wash cycle includes one wash with hot water and detergent (150°F/66°C min) and one rinse with hot water and rinse-aid (180°F/82°C min).

Table of times

Standard cycle time with supply water at 122°F/50°C.

			
LS6AH / WT30H	120 sec.	180 sec.	240 sec.

A device lengthens the cycle time if the water in the boiler has not reached the minimum temperature for correct rinsing.

The cycle times and the temperature may be personalised (e.g. increase of the rinse time and temperature). The cycle times should only be set by an Authorized Service technician.

D3 OPERATION

The filling and heating stage has finished when the display shows the tank temperature:

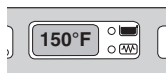

The appliance is then ready for use:

- Open the door.
- Pour the required amount of detergent into the tank (in models without automatic dispenser).
- Insert the rack containing the dirty dishes.

Close the door and select the suitable wash cycle; the corresponding indicator light comes on and the wash cycle starts:

- Cycle I

For lightly soiled dishes: press "J" button (Figure 15)

(see table of times).

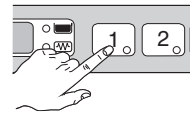

- Cycle II (recommended)

For normally dirty dishes: press "H" button (Figure 15) (see table of times).

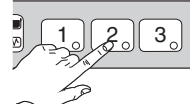

- Cycle III

For very dirty dishes: press "F" button (Figure 15) (see table of times).

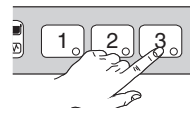

To stop the wash cycle, just press the selected cycle button or open the door.

- To continue the wash cycle, just press the selected cycle button or close the door. The cycle starts again from where it stopped.
- At the end of the wash, the dishwasher emits a series of beeps and "END" blinks on the display:



open the door and remove the rack containing the clean dishes.

WARNING

The appliance will not remove burnt food deposits from dishes. Dishes with burnt-on food deposits should be cleaned manually using detergent (for example, pre-wash under running water) before putting them in the dishwasher

Change the water in the tank at least twice a day.

Type of racks and loading

- YELLOW rack: for 18 plates with maximum diameter of 240 mm.

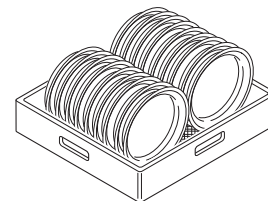

Figure 16

- BLUE rack for glasses: the glasses should be placed upside down.

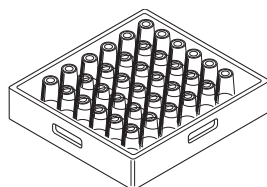

Figure 17

D4 END OF WORK AND DAILY CLEANING

The appliance is designed to carry out an automatic cleaning cycle to help flush out any residues and to guarantee greater health and hygiene:

- Open the door and take out the rack containing the clean dishes.
- Remove the tank filters and the overflow “W”.

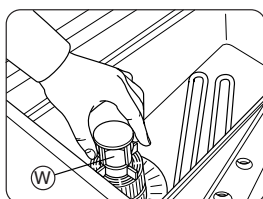
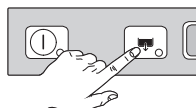

Figure 18

- Close the door.
- Select the drain cycle by pressing “B” button (Figure 15).



The message "CLE" ("CLEAN") will be displayed throughout the drain cycle:



- After a few minutes, 3 beeps indicate the end of the cleaning cycle and “END” blinks on the display:

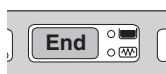

- Switch off the dishwasher by pressing “A” button (Figure 15).

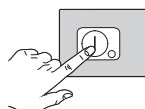

- Switch unit off at the main circuit breaker.
- Close the water shutoff valve.
- Replace the filters and the overflow.

- Remove the top and bottom jets “F” and “I”, unscrewing the ring nut “H”.

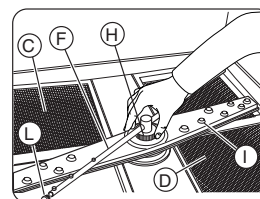

Figure 19

- Unscrew plugs “L” from the rinse jets and clean using a water spray. Do not use sharp implements to clean the nozzle holes, which could otherwise be damaged.
- Remove filters “C” and “D” and clean them under a water spray.
- Remove the filter “Z” and clean away any stuck on food in order to avoid blocking the draining system.

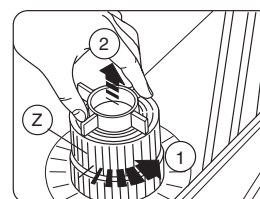

Figure 20

Upon completion of cleaning operations, replace the parts removed previously.

Cleaning the exterior surfaces

Before carrying out any cleaning operations, turn off the power at the main circuit breaker.

Clean the stainless steel surfaces using warm soapy water; never use detergents containing abrasive substances nor steel scrapers, common wire wool, brushes or scrapers; rinse thoroughly using a wet cloth and carefully wipe dry. Clean the control panel using a soft damp cloth and a neutral detergent if necessary.

Do not wash the appliance using direct or high-pressure water jets. To reduce the emission of pollutants into the environment, clean the appliance (externally and where necessary internally) with products having a biodegradability of over 90%.

CAUTION: Never stand or sit on the door, do not place heavy boxes or crates on the door.

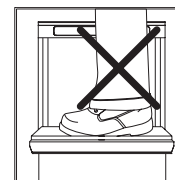

D5 MAINTENANCE

DELIMING

WARNING: DELIMING SOLUTION, RINSE AGENTS OR ANY OTHER KIND OF ACID MUST NOT COME IN CONTACT WITH BLEACH OR RINSE SOLUTION CONTAINING BLEACH USED IN CHEMICAL-SANITIZING MACHINES. MIXING MAY CAUSE HAZARDOUS GAS TO FORM. THIS ENTIRE PROCEDURE MUST BE FOLLOWED STEP BY STEP FOR SAFE AND SATISFACTORY RESULTS.

DELIME THE DISHWASHER ON A REGULAR BASIS AS REQUIRED. The regularity will depend on mineral content of the supply water. Deliming should be done when you can see clear signs of lime deposits (a white, chalky substance) on the inside walls and on the wash arms. If deliming is necessary, a deliming agent should be used for best results.

Step 1 - Discharge tank dirty water

Open the door and remove any baskets that are in chamber. Remove tank filters and overflow "W".

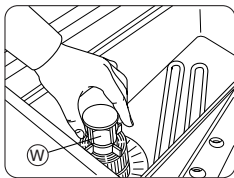

Close the door and select the drain cycle by pressing the "B" button (Figure 15).

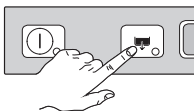

The message "CLE" ("CLEAN") will be displayed throughout the drain cycle.



After a few minutes, 3 beeps indicate the end of the cleaning cycle and "END" blinks on the display:

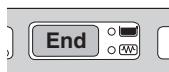

At the end of drain cycle, open the door, replace the overflow "W" and close the door.

Switch off the dishwasher by pressing "A" button (Figure 15)

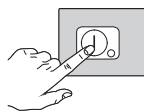

Step 2 - Filling tank and heating water

Press on/off "A" button (Figure 15).



The indicator light of the on/off button "A" comes on, indicating the dishwasher is powered and the water is being introduced and heated. The word "FILL" scrolls across display during the entire filling and heating stage.



The filling and heating stage has finished when the display shows the tank temperature:



Step 3 - Pour the deliming agent

Open the door, pour the required amount of deliming agent regarding agent concentration suggested by agent supplier for 6 gallons/23 liters of water.

Step 4 - Start the wash cycle and discharge the tank

Close the door and start the **Cycle III** by pressing "F" button (Figure 15). The wash cycle duration is 4 minutes.

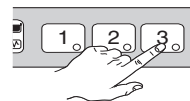

At the end of the cycle the dishwasher emits a series of beeps and "END" blinks on the display.

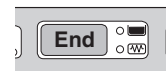

CAUTION: observe chemicals producers instructions handling appliance where chemicals have been used.

CAUTION: do not allow the deliming agent to remain in the machine longer than recommended by the deliming agent supplier.

7. Repeat the step 1.

To delime the boiler, call your authorized service company.

Prolonged period of inactivity

If the dishwasher is not to be used for a long time, proceed as follows:

- Close the water supply shutoff valve.
- Completely drain the tank.
- Remove and carefully clean the filters.
- Completely drain the incorporated dispenser hoses, removing them from the containers. Repeat the pro-

cedure described in the paragraph “Manual activation” at least 3 times.

- Completely drain the boiler by simultaneously pressing the buttons as shown in the figure.

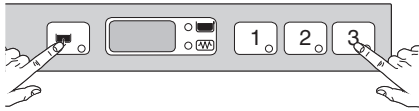

A buzzer indicates completion of drainage.

- Spread a thin film of petroleum jelly over all the stainless steel surfaces.

Preventive maintenance

The preventive maintenance message “CALL” may be activated.

Upon reaching the set number of cycles (e.g. 20000),



appears on the display. This message advises calling a qualified authorized service technician for a general check-up on of the state of the appliance.

NOTICE: CONTACT YOUR AUTHORIZED SERVICE COMPANY TO PERFORM MAINTENACE AND REPAIRS

NOTICE: Using any parts other than genuine factory manufactured parts relieves the manufacturer of all warranty and liability.

NOTICE: Manufacturer reserves the right to change specifications at any time without notice.

WARNING: The equipment warranty is not valid unless the appliance is installed, started and demonstrated under the supervision of factory trained installer.

WARNING: The unit must be installed by Personnel who are qualified to work with electricity and plumbing. Improper installation can cause injury to personnel and/or damage to the equipment. The unit must be installed in accordance with applicable codes.

D6 UNDERCOUNTER DISHWASHER WITH INCORPORATED CONTINUOUS WATER SOFTENER

These models have a continuous softener in the dishwasher water circuit. By means of special resins, this device removes the calcareous substances from the feed water, supplying decalcified water for washing.

For the continuous softener to work properly the resins must be regenerated periodically, with frequency depending on the hardness of the water and the number of wash cycles carried out.

Unlike conventional water softeners, this continuous softener does not require machine stops for regenerating the resins.

Salt container

The water can only be softened if there is salt in the special container. The salt container must be filled when the dishwasher is used for the first time and whenever the message **SAL 0** is displayed at the start of a wash cycle.

No salt in the container

If the message **SAL 0** is displayed at the start of a wash cycle, it means that the salt container is empty. Wash cycles can be started just the same, even if the display signals no salt; in which case the water used for washing is not softened.



IMPORTANT:

Open the salt container only when the message **SAL 0 is displayed. Opening the cap when the message **SAL 0** is not displayed can cause spilling of the saline solution and compromise correct machine operation.**

How to fill the salt container

- Switch off the dishwasher by pressing button “A” (Figure 15).

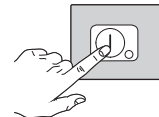

- Unscrew cap "A" (Figure 21) of the salt container, turning it anticlockwise.

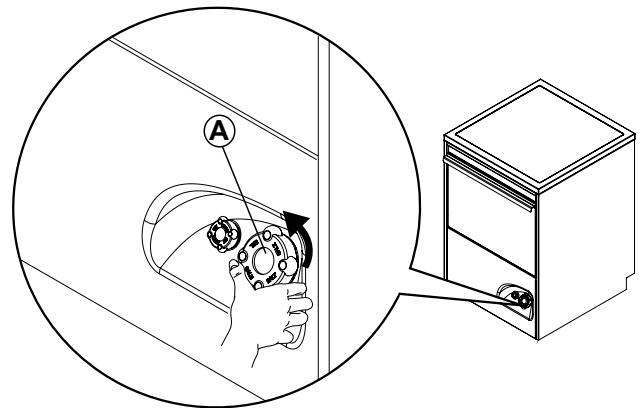

Figure 21

- Pour approx. 1.5 kg of coarse salt [NaCl] in container "A" (an amount sufficient to fill the salt container up to the rim) using the special funnel supplied (Figure 22).

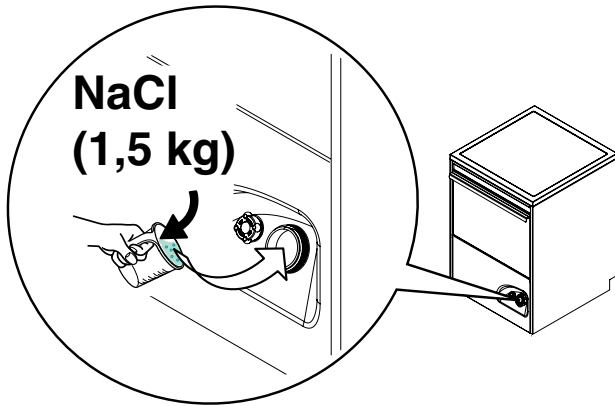

Figure 22



IMPORTANT:

only salt may be placed in the salt container. Do not introduce any other chemical substances such as detergent, rinse aid or descaling agent, since these would inevitably damage the appliance. Such damage invalidates any warranty and relieves the manufacturer of all liability.

- Remove any traces of salt from the filling hole, the container thread and the closing cap seal.
- Refit the cap of container "A", turning it clockwise and making sure it is tight.



IMPORTANT:

The message **SAL 0** may appear for several wash cycles even after topping-up the salt, as the salt must circulate in the entire system. Correct operation of the dishwasher is not, however, affected.

The salt container always has water in it, therefore it is normal if water comes out during filling.

Rinse-aid container

In undercounter models with incorporated continuous water softener, the rinse-aid container is located in the front panel of the appliance (Figure 23).

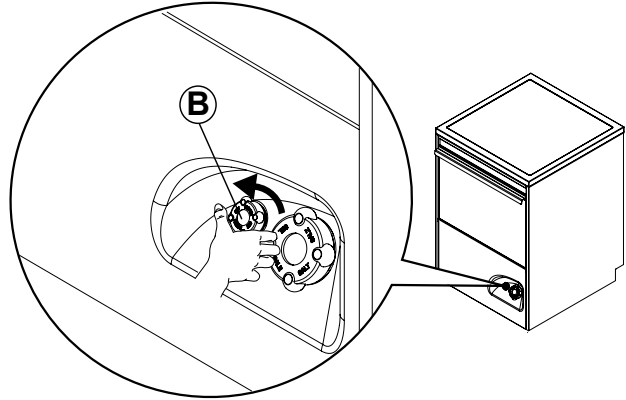

Figure 23

How to fill the rinse-aid container

- Unscrew cap "B" (Figure 23) turning it anticlockwise.
- Pour the rinse-aid in container "B" up to the rim.



IMPORTANT:

Only introduce rinse-aid in the rinse-aid container. Do not introduce other chemical substances such as detergent, descaling agent or salt, since these would inevitably damage the appliance. Such damage invalidates any warranty and relieves the Manufacturer of all liability.

- Refit the cap of container "B", turning it clockwise and making sure it is tight.

DISHWASHER DOES NOT WASH WELL	<ol style="list-style-type: none"> 1. Check if the suction filter is dirty, if so clean it thoroughly. 2. Check if the wash jets are clogged by solid food particles. 3. Check that the initial amount of detergent or subsequent additions are correct. 4. The selected wash cycle is too short. Repeat the cycle. 5. Check that the tank temperature is between 131°F/50°C and 150°F/65°C. 6. Check that the dishes are stacked correctly in the racks.
GLASSES AND DISHES ARE NOT DRIED PROPERLY	<ol style="list-style-type: none"> 1. To be performed by authorized service technicians: check the instructions for the amount of rinse-aid. 2. Check that there is rinse-aid in the container and if necessary top off level. 3. Check the set amount of rinse-aid (see “setting the dispensers” paragraph). 4. Check that the water temperature is between 176°F/80°C and 194°F/90°C.
CONDENSATION ON GLASSES	<ol style="list-style-type: none"> 1. Check that there is rinse-aid in the container and if necessary top off level. 2. Check the set amount of rinse-aid (see “setting the dispensers” paragraph). 3. Remove the rack of glasses immediately the cycle has ended.
STAINS ON THE GLASSES	<ol style="list-style-type: none"> 1. Only use “non-foaming” products for professional dishwashers.
EXCESSIVE FOAM IN THE TANK	<ol style="list-style-type: none"> 1. Check that the wash water temperature is not less than 122°F/50°C. 2. To be performed by authorized service technicians: check if the amount of product dispensed by the detergent dispenser is excessive. 3. Ensure that the tank has not been cleaned with unsuitable cleaners. Drain the tank and rinse thoroughly before new wash cycles. 4. If a foaming detergent has been used, drain and refill the tank with water until the foam disappears.
SMEARS OR SPOTS ON THE GLASSES	<ol style="list-style-type: none"> 1. Reduce the amount of rinse-aid (see “setting the dispensers” paragraph).
THE WASH OR RINSE ARMS TURN SLOWLY	<ol style="list-style-type: none"> 1. Remove and thoroughly clean the arms. 2. Clean the wash pump suction filter.

