

**Frozen Beverage Dispensers**  
EVERYONE LOVES FROZEN®

# 77X SERIES

## INSTALLATION & OPERATION MANUAL



**MODELS**  
**771/772/773/774**

24-77XM-0012\_06

This manual is for general informational purposes only and is not intended to cover every potential installation or operational possibility. The parts and equipment addressed herein are warranted only to the extent covered by FBD's Parts and Equipment Warranty. FBD makes no express warranties as to any matter whatsoever and hereby disclaims all implied warranties including, without limitation, the implied warranties of merchantability and fitness for any particular purpose. In no event shall FBD be liable or obligated to any customer or to any third party for incidental, consequential, or special damages, regardless of the theory of liability, arising out of, or in any manner related to FBD parts, equipment or any delay with respect to its delivery.

The information contained in this document is subject to change without notice.

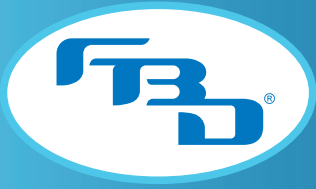
© 2025 FBD Partnership, L.P. All Rights Reserved.

**FBD TECHNICAL SUPPORT: 866-323-2777 (U.S.), 852-2369-3998 (INTERNATIONAL), or [www.fbdfrozen.com](http://www.fbdfrozen.com)**



**TABLE OF CONTENTS**

<b>1. SAFETY</b> .....	<b>3</b>
1.1 ELECTRICAL.....	3
1.2 COMPRESSED GASES .....	3
1.3 GENERAL PRECAUTIONS.....	4
1.4 INSULATION BLOWING GAS .....	4
1.5 CLIMATIC CLASSES .....	4
1.6 UNIT IN STORAGE .....	4
<b>2. SPECIFICATIONS AND REQUIREMENTS</b> .....	<b>5</b>
2.1 GENERAL REQUIREMENTS.....	5
2.2 ELECTRICAL REQUIREMENTS.....	5
2.3 DIMENSION AND WEIGHT SPECIFICATIONS.....	6
<b>3. RECEIVING AND UNPACKING DISPENSER</b> .....	<b>7</b>
3.1 RECEIVING.....	7
3.2 UNPACKING .....	7
<b>4. INSTALLATION</b> .....	<b>7</b>
4.1 GENERAL LOCATION REQUIREMENTS .....	7
4.2 DISPENSER MOUNTING .....	7
4.3 INSTALLATION FOR EASIER SERVICE .....	8
4.4 SELF-CONTAINED REFRIGERATION MODELS.....	9
4.5 REMOTE-CONDENSING MODELS.....	9
4.6 WATER-CONDENSING MODELS.....	9
4.7 UNIVERSAL GAS CONFIGURATIONS.....	9
4.8 PREPARE ELECTRICAL POWER CONNECTION .....	10
4.9 SUPPLY CONNECTIONS.....	11
4.10 CONNECTING TO WATER SUPPLY .....	12
4.11 CONNECTING TO GAS SUPPLY .....	12
4.12 CONNECTING TO SYRUP SUPPLY.....	12
<b>5. STARTING UP THE DISPENSER</b> .....	<b>13</b>
5.1 LEAK CHECK AND PRIME .....	13
5.2 INITIAL POWER UP .....	14
5.3 WATER FLOW RATE AND BRIX.....	15
5.4 FILLING BARREL AND STARTING .....	16
<b>6. DISPENSER OPERATION</b> .....	<b>17</b>
6.1 FREEZE.....	17
6.2 OFF.....	17
6.3 DEFROST.....	17
6.4 DRINK QUALITY.....	17
6.4.1 DRINK TOO “FIRM” OR COLD .....	18
6.4.2 DRINK TOO “SLOPPY” OR WARM .....	18
6.4.3 DRINK TOO HEAVY .....	18
6.4.4 DRINK TOO LIGHT .....	18
<b>7. MENUS AND NAVIGATION</b> .....	<b>19</b>
7.1 KEYPAD.....	19
7.2 HOME MENU .....	20
7.3 POP-UP MENU.....	20
7.4 MENU TREE.....	21
7.5 MAIN MENU .....	22
7.6 READOUTS MENU .....	22
7.7 FAULT CODE HISTORY MENU.....	23
7.8 SERVICE MENU.....	23
7.9 MAINTENANCE MENU.....	24



**TABLE OF CONTENTS (CONTINUED)**

7.10 SETTINGS MENU .....	26
7.11 CLOCK AND SCHEDULE MENU.....	29
7.12 DATE AND TIME MENU.....	29
7.13 DEFROST SCHEDULE MENU.....	30
7.14 AUTO DEFROST MENU .....	30
7.15 WAKE/SLEEP SCHEDULE MENU .....	31
7.16 MANUAL ON/OFF MENU .....	31
7.17 BEVTRAK™ MENU .....	32
7.18 MODEM SETTINGS MENU.....	32
7.19 MACHINE TOTALS MENU .....	33
7.20 RESTORE FACTORY SETTINGS MENU .....	33
7.21 DIAGNOSTICS MENU .....	34
<b>8. CLEANING AND SANITIZING.....</b>	<b>35</b>
8.1 GENERAL INFORMATION.....	35
8.2 DAILY CLEANING .....	35
8.3 SANITIZING.....	35
<b>9. PREVENTIVE MAINTENANCE.....</b>	<b>37</b>
9.1 AIR FILTER CLEANING .....	37
9.2 REAR SEAL REPLACEMENT .....	38
9.3 BACKFLOW PREVENTER MAINTENANCE .....	39
9.4 SERVICING THE PRODUCT TRAY .....	39
<b>10. TROUBLESHOOTING .....</b>	<b>40</b>
10.1 HOME MENU MESSAGES.....	40
10.2 FAULT CODES.....	42
10.3 DIAGNOSTIC FAULT CODES.....	49
<b>11. DIAGRAMS AND SCHEMATICS .....</b>	<b>51</b>
11.1 FLOW DIAGRAMS (MULTI-FLAVOR DISPENSERS).....	51
11.2 FLOW DIAGRAMS (STANDARD DISPENSERS).....	53
11.3 ELECTRICAL WIRING DIAGRAMS (MULTI-FLAVOR DISPENSERS) .....	54
11.4 ELECTRICAL WIRING DIAGRAMS(STANDARD DISPENSERS) .....	57
11.5 REFRIGERATION SCHEMATIC DIAGRAMS (AIR-COOLED DISPENSERS).....	60
11.6 REFRIGERATION SCHEMATIC DIAGRAMS (REMOTE CONDENSING DISPENSERS) .....	62
11.7 REFRIGERATION SCHEMATIC DIAGRAMS (WATER-COOLED DISPENSERS).....	63



# 1. SAFETY

## 1.1 Electrical

This dispenser must be properly electrically grounded to avoid possible fatal electrical shock or serious injury to the operator. The power cord is provided with a three-prong grounded plug. If a three-hole grounded electrical outlet is not available, use an approved method to ground the dispenser. Only qualified electricians should perform this task and the work performed should meet all applicable codes.

The plug must be accessible at all times so that the dispenser can be shut off in case of emergency. Always disconnect electrical power to the dispenser to prevent personal injury before attempting any internal maintenance.

There is a switch on the front of the dispenser's e-box that acts as an interrupt to the main control board (see **Section 7.1** for more information). When the switch is in the OFF position, the dispenser will remain powered but the control board will not. Only qualified personnel should service internal components or electrical wiring.

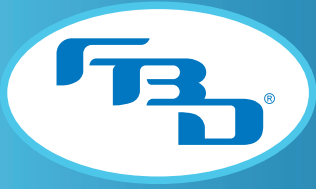
## 1.2 Compressed Gases



Strict attention must be observed in the prevention of gas leaks in the entire gas and frozen drink system. If a gas leak is suspected, immediately ventilate the contaminated area before attempting to repair the leak as prolonged exposure to high concentrations of carbon dioxide (CO<sub>2</sub>) or nitrogen (N<sub>2</sub>) could lead to death. Personnel exposed to high concentrations of CO<sub>2</sub> gas may experience dizziness, asphyxiation, confusion, fatigue, headaches, and/or tremors which are followed rapidly by loss of consciousness and suffocation. Personnel exposed to high concentrations of N<sub>2</sub> gas may experience dizziness, drowsiness, nausea, vomiting, diminished mental alertness, and/or loss of consciousness.

All applicable laws and regulations pertaining to the use, storage, and transport of gas cylinders must be observed. To avoid personal injury and/or property damage, always secure gas cylinders in an upright position with a safety chain. A gas cylinder with a damaged or detached valve can cause serious personal injury.

When using compressed air for the active charge system, all air compressor equipment must be operated only by authorized and trained personnel. The air intake should be from a clean, outside, fresh air source. If local laws and regulations require it, screens or filters to clean the air should be used based on equipment manufacturer's recommendations. Air compressors should never be operated at speeds faster than the manufacturer's recommendation and equipment should not be allowed to become overheated.



### 1.3 General Precautions

This equipment, depending on the model, weighs up to 418 pounds (190 kilograms) when empty and is top-heavy. To avoid personal injury or equipment damage, do not attempt to lift the dispenser without help. The use of a mechanical lift is highly recommended. When lifting and positioning the dispenser, it should always stay in a vertical upright position.

When the dispenser is mounted onto a base cart, it must be secured with bolts as instructed in Section 4.2. Use caution when moving the cart. Avoid surfaces that are not level and smooth under the width of the casters to prevent tipping.



### 1.4 Insulation Blowing Gas

This equipment was built using polyurethane foam. For safety, please keep dispenser away from fire.

### 1.5 Climatic Classes

This equipment may be rated for climatic classes 0, 1, 2, 3, 4, 5, 6, 7, or 8. The table below provides additional information on the specific temperature, relative humidity, and moisture content acceptable under these climatic classes. However **Sections 5.1 & 5.2** of this manual provide additional information on required environment for optimal performance of the dispenser. Please make sure the dispenser is installed and operated in conditions described in **Sections 4.1 and 4.4**. Reference dispenser nameplate label to identify climatic class.

Climatic Class	Dry Bulb Temperature (°C)	Relative Humidity (%)	Dew Point Temperature (°C)	Moisture Content (g/Kg)
0	20	50	9.3	7.3
1	16	80	12.6	9.1
2	22	65	15.2	10.8
3	25	60	16.7	12.0
4	30	55	20.0	14.8
5	40	40	23.9	18.8
6	27	70	21.1	15.8
7	35	75	30.0	27.3
8	23.9	55	14.3	10.2

### 1.6 Unit in Storage

If a unit is going to be placed in storage for an extended period (more than 90 days), it is recommended that all rubber components be replaced (o-rings, rear seal, expansion tank, etc.). Failure to replace rubber components could cause leaks which may damage components.



## 2. SPECIFICATIONS AND REQUIREMENTS

### 2.1 General Requirements

Requirement	
Syrup Supply Pressure	70 - 72 PSI* (483 - 496 kPa)
Water Supply Pressure	30 PSI (207 kPa) Minimum Flowing Pressure 70 PSI (483 kPa) Maximum Static Pressure
Gas Supply Pressure	70 - 72 PSI (483 - 496 kPa)
Clearance	3" (76 mm) Sides and Back, 12"-36" (304 mm - 914 mm) Top <sup>†</sup>
Refrigerant <sup>‡</sup>	R404-A <b>OR</b> R448-A

### 2.2 Electrical Requirements<sup>§</sup>

Requirement			
Frequency		60 Hz	50 Hz
Operational Voltage		230 VAC ± 10%	230 VAC ± 10%
Current	771	20 A	20 A
	772	20 A	20 A
	773	30 A	30 A
	774	30 A	30 A
Minimum AMP Breaker	771/772	20	20
	773/774	30	30

\* All pressure values are listed in the manual in gauge pressure.

<sup>†</sup> 12" (304 mm) with side or back open-air conditions, 36" (914 mm) in equipment alcove.

<sup>‡</sup> Reference dispenser nameplate label to identify refrigerant type.

<sup>§</sup> General requirements only. Always check dispenser nameplate label for specific rating information.



## 2.3 Dimension and Weight Specifications

### Multi-Flavor Dispensers

Specification	771 MFLV	772 MFLV
Width	17.0" (432 mm)	17.0" (432 mm)
Depth	32.5" (826 mm)	32.5" (826 mm)
Height - Short Door	34.0" (864 mm)	34.0" (864 mm)
Height - Tall Door	41.3" (1,049 mm)	41.3" (1,049 mm)
Weight - Empty	288 lb (131 kg)	310 lb (141 kg)
Weight - Operational	295 lb (134 kg)	333 lb (151 kg)
Weight - Shipping	304 lb (138 kg)	346 lb (157 kg)

### Standard Dispensers

Specification	772	773	774
Width	17.0" (432 mm)	20.3" (516 mm)	26.0" (660 mm)
Depth	32.5" (826 mm)	32.5" (826 mm)	32.5" (826 mm)
Height - Short Door	34.0" (864 mm)	34.0" (864 mm)	34.0" (864 mm)
Height - Tall Door	41.4" (1,052 mm)	41.4" (1,052 mm)	41.4" (1,052 mm)
Air-Cooled Dispensers			
Weight - Empty	298 lb (135 kg)	359 lb (163 kg)	418 lb (190 kg)
Weight - Operational	321 lb (146 kg)	393 lb (178 kg)	464 lb (211 kg)
Weight - Shipping	338 lb (153 kg)	404 lb (183 kg)	468 lb (212 kg)
Remote Condensing Dispensers			
Weight - Empty	283 lb (128 kg)	343 lb (156 kg)	400 lb (182 kg)
Weight - Operational	306 lb (139 kg)	377 lb (171 kg)	446 lb (202 kg)
Weight - Shipping	323 lb (147 kg)	388 lb (176 kg)	450 lb (204 kg)
Water-Cooled Dispensers			
Weight - Empty	295 lb (134 kg)	356 lb (162 kg)	415 lb (188 kg)
Weight - Operational	318 lb (144 kg)	390 lb (177 kg)	461 lb (209 kg)
Weight - Shipping	335 lb (152 kg)	401 lb (182 kg)	465 lb (211 kg)



## 3. RECEIVING AND UNPACKING DISPENSER

### 3.1 Receiving

Each dispenser is tested and thoroughly inspected before shipment. At the time of shipment, the carrier accepts the dispenser and any claim for damages must be made with the carrier. Upon receiving the dispenser from the delivering carrier, carefully inspect carton for visible indication of damage. If damage is present, have carrier note same on bill of lading and file a claim with the carrier.

### 3.2 Unpacking

- A. Cut banding from shipping carton and remove carton by lifting up. Remove protective side panels and four corner protectors.
- B. If included, remove drip tray assembly and accessory kit from top packaging. Contact the dealer if any parts are missing or damaged.
- C. Remove side panels from dispenser.
- D. Inspect dispenser for concealed damage. If evident, immediately notify delivering carrier and file a claim against same.
- E. If dispenser is received with a shipping pallet attached to the bottom, remove shipping pallet from bottom of dispenser by accessing and removing the bolts located on the under side of the shipping pallet.
- F. Lift dispenser up by the frame cross bracing and remove lower portion of carton.

## 4. INSTALLATION

### 4.1 General Location Requirements

Dispenser is intended for indoor use only. A flat, level location is required for proper installation. When using a counter, ensure it will support the weight of the dispenser plus the weight of any equipment placed near it. See the specifications section for equipment weights.

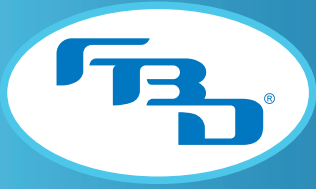
Adequate space above and behind the dispenser is required to allow:

1. Removal of side panels, if service is necessary.
2. Air circulation around vents on sides, back, and top of dispenser.

A well-ventilated room is required for the dispenser. The environment, however, should be stable and not subject to abrupt changes in temperature. The dispenser should not be exposed to direct sunlight or chemicals.

### 4.2 Dispenser Mounting

Countertop - Leg Mounting: Another countertop option is to install 4" support legs (sold separately) to allow for easy cleaning around and under the dispenser. The legs install easily into the same four holes used to bolt the frame to the shipping pallet. As an added benefit, this installation typically meets state and local health department codes.



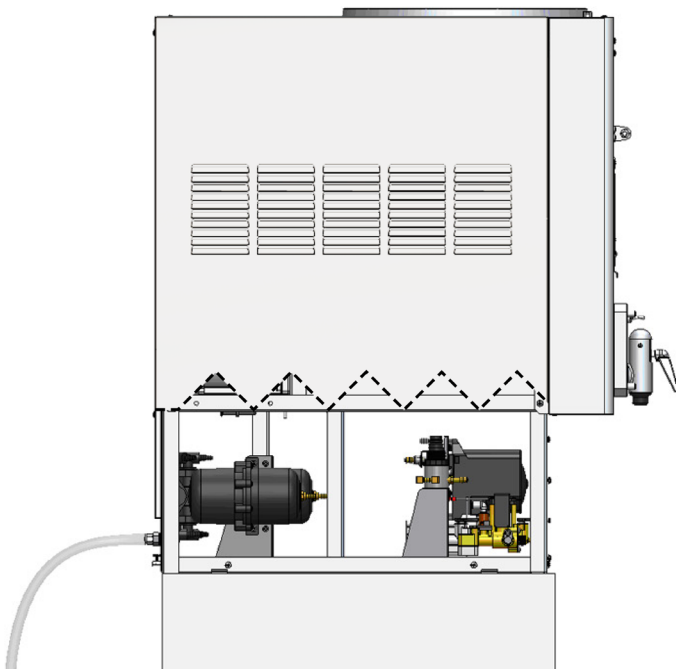
**Base Cart:** A roll-around base cart (sold separately) can be used when a suitable countertop location is not available. Dispensers installed to base carts must be bolted to the cart to avoid the dispenser from falling off which could result in serious injury or death. Once installed, seal the dispenser to the cart using a bead of clear silicone caulk around the base of the frame.

### 4.3 Installation for Easier Service

The 77x series of dispensers have a removable product tray to help with servicing the dispenser. The tray may be either completely removed (for access to back components) or it can partially slide out (for access to front components) as shown in **Figure 4.2**. The dispenser must be properly installed to take advantage of these features.

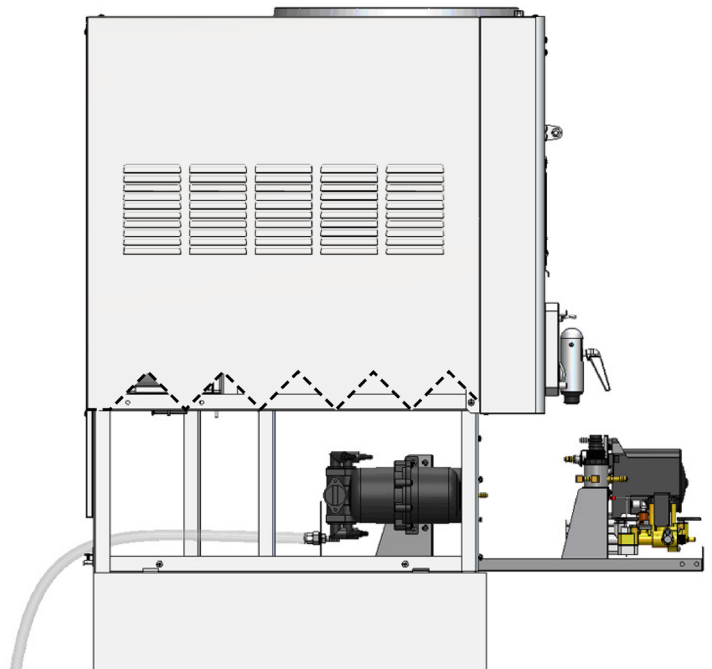
Use the straight fittings found in standard FBD dispenser install kits (sold separately) when connecting the water, CO<sub>2</sub> or N<sub>2</sub> gas, and syrup lines to the dispenser.

Allow for an extra 18 inches (46 cm) of tubing in the lines for standard dispensers, and 24 inches (61 cm) for multi-flavor dispensers. This extra slack will be useful when the tray is later pulled out for service.



**Figure 4.1 Product Tray Pushed In**

Space must be provided for the extra tubing to be coiled up behind the dispenser. Take care that it does not get pinched or kinked.



**Figure 4.2 Product Tray Partially Pulled Out**

Straight fittings allow the tubing to remain connected while working on the tray.



## 4.4 Self-Contained Refrigeration Models

Adequate clearance around the dispenser is required for proper air flow. Failure to provide proper clearance will reduce capacity and can damage the refrigeration system. See the specifications page for clearance requirements. Avoid enclosed installations if possible; recirculated hot discharge air from the dispenser can impact performance or damage the system. Such installations require supplemental ventilation such as a fan with a thermal switch to remove the hot discharge air.

An ambient temperature of no more than 75°F (24°C) provides the optimal capacity. As the ambient temperature increases, the dispenser capacity decreases. It is essential that the HVAC system be sized to handle the additional heat load from all self-contained, air-cooled dispensers. If ambient heat is a concern, FBD recommends a remote-condensing dispenser.

## 4.5 Remote-Condensing Models

Remote-condensing models utilize a condenser assembly external to the building and are designed for ambient temperatures from -10°F to 120°F (-23°C to 49°C). This configuration removes the heat and fan noise from the inside environment and reduces the air conditioning load during the warm season. Because air flow is not a high concern with this set up, this style dispenser is suitable for enclosed spaces and zero side clearance installations (dispensers side-by-side). Remote condensing models utilize a small air recirculation fan located on the top of the dispenser that runs continuously. If your dispenser has an opening on the top panel for the fan, do not stack objects on top of the dispenser as this will block the airflow and damage the fan. Refer to FBD's Remote Condenser Installation Addendum for more information.

## 4.6 Water-Condensing Models

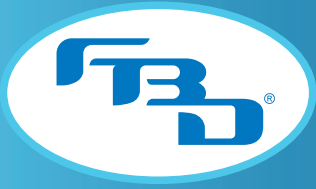
Water-condensing models have specific water flow rate and temperature requirements. The minimum required volumetric flow rate is 3.5 gallons (13.2 L) per minute and the allowable water inlet temperatures should not exceed 75°F (24°C). Water flow rates below the recommended amount or temperatures in excess of recommended temperature will cause significantly degraded performance and possibly damage the dispenser. Water-condensing models utilize a small air recirculation fan located on the top of the dispenser that runs continuously. If your dispenser has an opening on the top panel for the fan, do not stack objects on top of the dispenser as this will block the airflow and damage the fan.

## 4.7 Universal Gas Configurations

Some 77X dispensers are equipped with our Universal Gas feature. Dispensers with Universal Gas functionality can use more than one type of gas at a time which allow for additional flexibility in configuration of the dispenser. For example, while one type of gas drives the dispenser's pneumatic parts, another gas is injected into the drink. Universal Gas dispensers have separate connections (labeled on the dispenser's bulkhead) for each gas used: Main Gas, Gas 1, and Gas 2.

**Main Gas:** The gas fed to the Main Gas connection operates the dispenser's pneumatic components (the water pump, active charge, and any pneumatic faceplates). Compressed air, CO<sub>2</sub>, or N<sub>2</sub> can be used as the dispenser's Main Gas.

**Gas 1** (all dispensers) **and Gas 2** (772 MFLV): The gas (CO<sub>2</sub>, or N<sub>2</sub>) fed to the Gas 1 and Gas 2 connection is injected into the drink. Any barrel on a 772 MFLV dispenser can be set up to inject either CO<sub>2</sub>, or N<sub>2</sub> into that barrel's product.



The Universal Gas setup allows the operator to adjust the levels of Gas 1 and 2 injected into the drink (a drink's expansion refers to the amount of gas injected). The table below lists the available drink types depending on which gas is selected for Gas 1 or Gas 2 (where applicable).

Universal Configuration Drink Types				
Dispenser	Main Gas	Gas 1	Gas 2	Available Drink Types
771 Multi-Flavor	CO <sub>2</sub> , N <sub>2</sub> , or Air	CO <sub>2</sub> or N <sub>2</sub>	N/A	CO <sub>2</sub> : Medium Expansion and High Expansion N <sub>2</sub> : Medium Expansion
772 Multi-Flavor	CO <sub>2</sub> , N <sub>2</sub> or Air	CO <sub>2</sub> or N <sub>2</sub>	CO <sub>2</sub> or N <sub>2</sub>	CO <sub>2</sub> : Medium Expansion and High Expansion N <sub>2</sub> : Medium Expansion

## 4.8 Prepare Electrical Power Connection

The mating wall receptacle must match the amperage rating of the dispenser. If the plug on the dispenser is replaced with an alternate, it must have the same amperage rating and provide a grounding prong. The dispenser must be connected to a dedicated circuit with the proper amperage fuse rating; however, do not connect the dispenser to power at this time. This will be done when going through the dispenser's initial power up (Section 5.2).

The dispenser requires a single phase 230 VAC  $\pm$  10%. If the line voltage is above or below the required, a buck-boost transformer must be used. Operation above or below the required voltage may damage the dispenser and cause inconsistent performance. Operation outside the recommended voltage range also voids all warranties.

Remove the plug from the power cord and feed the cord through the strain relief located at the back of the dispenser. Tighten the strain relief securely. Reinstall the plug on the power cord and check for continuity on the plug across both "hot legs" and no continuity between each "hot leg" and ground.

**Note:** This dispenser is equipped with pressure limiting switch. The switch will be tripped if the dispenser's refrigeration system is over-pressurized, and will prevent the compressor from operating.



**Risk of Electric Shock:** If the cord or plug becomes damaged, replace only with a cord and plug of the same type provided by the manufacturer or service provider in order to avoid potential hazard.

**Do Not connect the dispenser to power at this time.**



## 4.9 Supply Connections

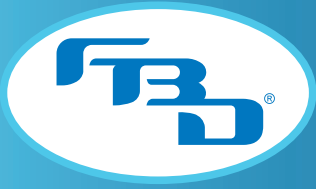
The water, syrup, and gas connections can be found at the back of the dispenser. All dispensers will have a bulkhead label near the bulkhead fittings illustrating which supply line connects to each fitting (**Figure 4.3**). The label will differ in size and shape based on the dispenser model. Please refer to the “Bulkhead Fittings” table in this section for additional information on the different connections.



**Figure 4.3 Bulkhead Fittings Label Location**

Bulkhead Fittings	
Fitting Label	Description
☉ H2O	Water supply connection.
☉ CO2	Carbon dioxide supply connection (for standard configurations).
☉ N2	Nitrogen supply connection (for nitrogen configurations).
☉ MAIN GAS	Connection for gas driving pumps, active charge system, and pneumatic faceplate on universal gas configurations. Can be compressed air, CO <sub>2</sub> or N <sub>2</sub> .
☉ GAS 1	Connection for gas being injected into product (for multi-flavor dispensers only). Can be CO <sub>2</sub> or N <sub>2</sub> . Gas 1 supplies barrel 1 on universal gas configurations.
☉ GAS 2	Connection for gas being injected into product (for multi-flavor dispensers only). Can be CO <sub>2</sub> or N <sub>2</sub> . Gas 2 supplies barrel 2 on universal gas configurations.
☉ SYRUP X*	Base syrup connection. The base flavor syrup in a given barrel.
☉ FLAV X*	Flavor shot connection. The flavor shot that will be mixed with a base syrup (on multi-flavor dispensers only).

\* “X” represents the barrel number for SYRUP connections, and the flavor number for FLAV connections.



## 4.10 Connecting to Water Supply

Water pipe connections and fixtures directly connected to a potable water supply shall be sized, installed, and maintained in accordance with federal, state, and local codes.

Before connecting water line to dispenser, flush several gallons of water through a newly fabricated line to remove any debris. Additionally, installing a shutoff valve near the connection will be helpful if the dispenser needs to be removed. Connect water line adapter to the bulkhead fitting labeled “H<sub>2</sub>O” on the back of the dispenser. The water supply line connected to the bulkhead fitting should be a minimum 3/8” ID or larger if required by local codes.

**Do not turn on the water supply at this time.**

**Note:** According to the National Sanitation Foundation (NSF), an ASSE 1022 approved backflow prevention device must be installed on the water supply line before connecting to the dispenser. If needed, one can be purchased from FBD under part number [12-2272-0001](#). The backflow device must have a line connected to the vent that diverts any flow to a drain. Failure to divert flow can result in water overflow.

## 4.11 Connecting to Gas Supply

The gas supply may come from either an independent tank with a primary/secondary regulator or a bulk tank that supplies other equipment. If the supply is from a bulk tank, tee off the main line and install a wall-mounted secondary regulator set to 70 PSI (483 kPa). Fabricate a 3/8” ID line from the secondary regulator (independent tank or wall mount) to the rear of the dispenser and connect to the appropriate bulkhead fitting. This regulator should only supply gas to the frozen beverage dispenser (and base cart if applicable). Installing a shutoff valve near the connection is recommended. For dispensers with multiple gas connections, verify the correct gas is connected to the correct fitting. If the dispenser is on a base cart with the BIBs and syrup pumps inside, then install a tee in the supply gas line to feed the syrup pumps.

**Do not turn on the gas supply at this time.**

## 4.12 Connecting to Syrup Supply

For installations requiring syrup lines less than 50 ft (15 m) in length, use tubing with a minimum ID of 3/8”. Run the syrup lines from the pumps to the rear of the dispenser and connect to the proper syrup or flavor fitting.

For installations requiring syrup lines over 50 ft (15 m) in length, use tubing with a minimum ID of 1/2”. Using tubing of any smaller diameter will lead to pressure fluctuations and false sold-out errors. Furthermore, consider installing booster pumps on the supply lines. Increasing the regulated gas pressure on the syrup pumps (without exceeding the syrup pump’s pressure rating) can also help maintain proper supply pressure at the dispenser.

In all situations, it is recommended to install a shutoff valve near the connection to the back of the dispenser to assist with servicing or removing the dispenser.

**Do not turn on the gas supply for the syrup pumps at this time.**



## 5. STARTING UP THE DISPENSER

### 5.1 Leak Check and Prime

1	Remove the side panels by loosening the two screws located at the bottom of the panel and then lifting off the frame.
2	Remove the drip tray by lifting up and pulling away, then remove the splash plate and access panel to expose the solution modules.
3	Connect the BIB connectors to the syrup BIBs.
4	Turn on the water and the gas supplies. Ensure both are flowing to the dispenser. <b>Note:</b> The water and syrup pumps will activate loudly until the lines are pressurized.
5	Thoroughly check for leaks at all connections.
6	Install a 1/4" ID tube on the sample port shown in <b>Figure 5.1</b> . Check that the water and syrup shutoffs are OPEN (as shown in <b>Figure 5.2</b> ) and then open the sample valve and collect the water/syrup in a cup. Continue to prime until syrup flow has been established and all air has been removed from the lines. Discard the samples. Repeat for all barrels.

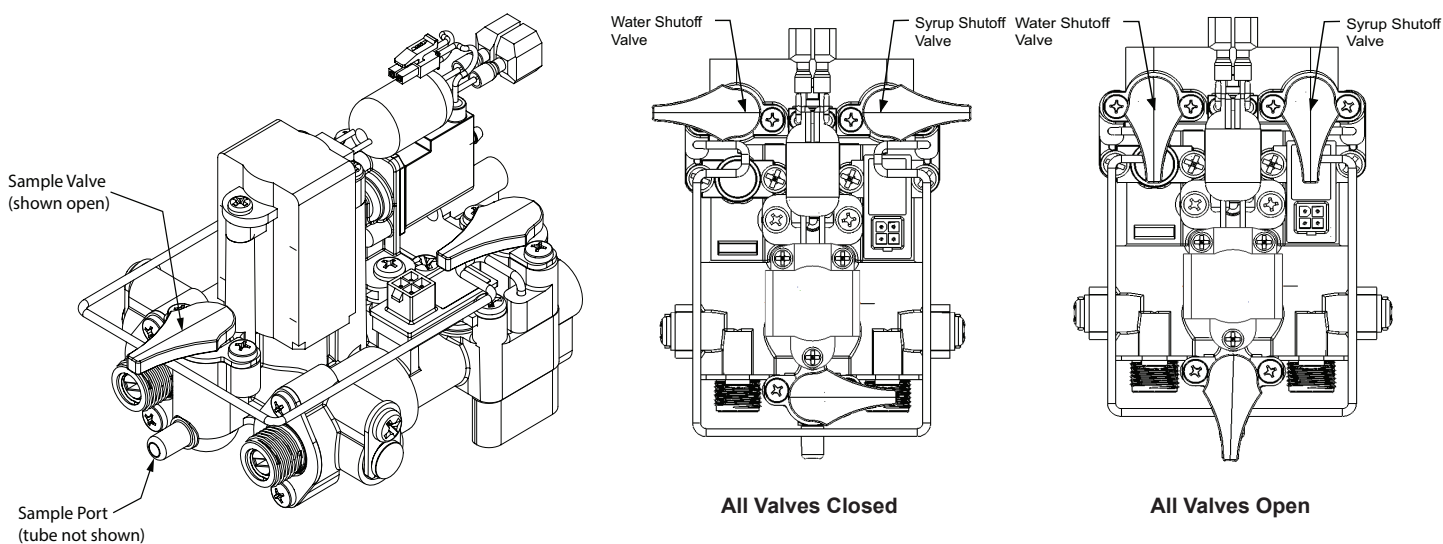
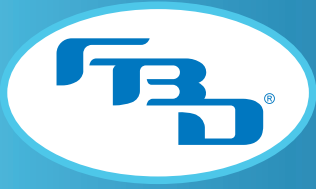


Figure 5.1 Sample Valve on Solution Module



## 5.2 Initial Power Up

Plug the dispenser into the power supply and verify the dispenser turns on by looking at the LCD located behind the merchandiser. Some models are equipped with an on/off switch; ensure the switch is in the ON position. The display should be on the home screen showing the status of the barrels (see **Section 7** for additional information on keypad buttons and how to navigate through menus). If the firmware has just been updated, then the dispenser will prompt the operator to answer the following questions:

1. Desired language.
2. Dispenser serial number.
3. Dynamic charge control.
4. Number of barrels.

After responding to the prompted questions, the home screen will be displayed.

Next, a few verifications will need to be made:

1	Press the green check button and then select the MENU option. Next, select the READOUTS option.
2	Press the COMMON button.
3	Verify the line voltage is at 230V $\pm$ 10%.
4	Verify the unregulated gas pressure (or "Main Gas" for universal gas configurations) is between 70 to 72 PSI (483 to 496 kPa) <sup>†</sup> and adjust the regulator if needed.
5	Verify the water pressure is between 85 to 92 PSI (586 to 634 kPa) <sup>†</sup> . This is not adjustable. <sup>‡</sup>
6	Verify the regulated gas pressure (or "Gas #1"/"Gas #2" for universal gas configurations) is approximately 60 PSI (414 kPa) and adjust the regulator if needed. <sup>§</sup>
7	Press the BARREL button.
8	Verify the syrup pressures are between 70 and 72 PSI (483 and 496 kPa) and adjust the back room regulator if needed.
9	Dispense product from the sample valve after adjusting any pressures. This will restabilize to the new pressure.

For multi-flavor dispensers, the following will also need to be completed:

10	Press the FLAVOR button in the READOUTS menu.
11	Verify the syrup pressures for each of the flavors are between 70 and 72 PSI (483 and 496 kPa) and adjust the regulator if needed.

**Note:** The voltage drop on the LCD between idle and run modes must not exceed 10 volts between the power source and the machine. If it is greater than 10 volts then the power supply is inadequate and needs to be addressed by a certified electrician.

<sup>†</sup> Use the display pressure readouts when adjusting the settings.

<sup>‡</sup> The water pump output pressure should be 15 to 20 PSI (103 to 138 kPa) above the unregulated gas (or "Main Gas") pressure. See the troubleshooting section if the pressures are not correct.

<sup>§</sup> The dispenser will automatically compensate for fluctuations in regulated gas (or "Gas #1"/"Gas #2") from 50 to 70 PSI (345 to 483 kPa). Ensure that during setup the regulated gas is set as close to 60 PSI (414 kPa) as possible.



### 5.3 Water Flow Rate and Brix

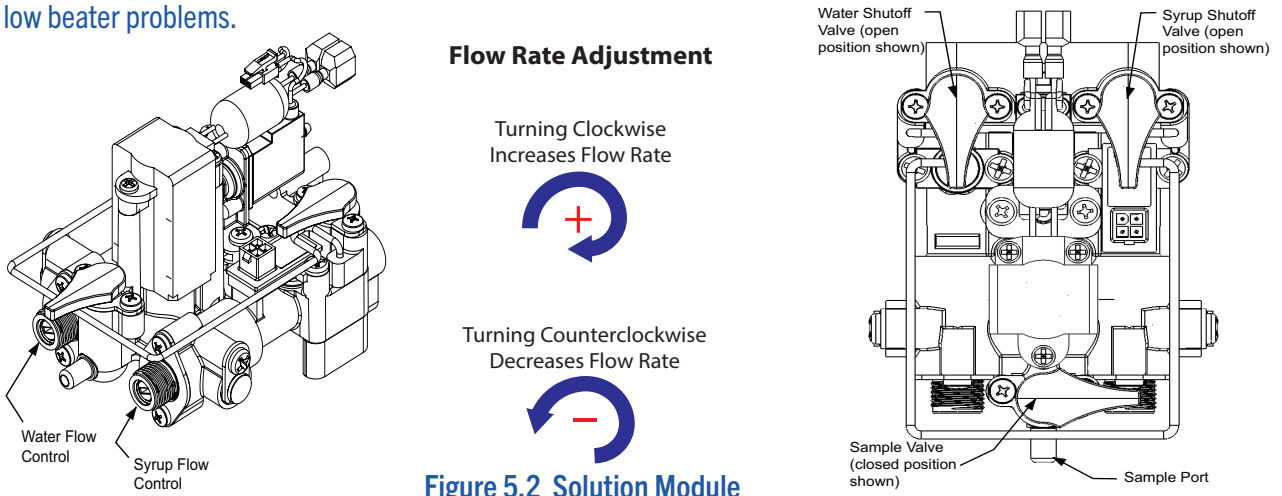
The water flow rate and brix for each barrel must be verified and adjusted for optimal performance. Use the following procedure to adjust the water flow rate and set the brix for each barrel:

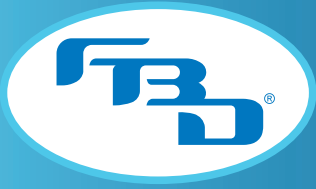
1	Turn the syrup shutoff valve to the CLOSED position ( <b>Figure 5.1</b> ).
2	Adjust the water flow rate to 1.5 oz/sec (44.4 ml/sec) by dispensing water from the solution module through the sample port for 10 seconds into a measuring cup. The amount measured should be 15 oz (444 ml). Turn the flow control clockwise to increase the flow and counterclockwise to reduce the flow. <b>Note:</b> The WATER AND BRUX CALIBRATION screen under the MAINTENANCE MENU can be used to help with timing.
3	Turn the syrup shutoff valve to the OPEN position and dispense a cup of fluid from the sample port to establish a stable flow.
4	Once a good water and syrup mixture is obtained, dispense a 16 oz sample and measure the sample brix with a refractometer. Be sure to thoroughly mix the sample first by pouring back and fourth between two cups.
5	Turn the syrup flow control counterclockwise to decrease the brix. Turn the syrup flow control clockwise to increase the brix.
6	Dispense and discard several samples after adjusting the brix.

For multi-flavor dispensers, the flavor injection modules will also need to be calibrated. Please refer to the Multi-Flavor Merchandiser Manual (24-M4MF-0001) for the calibration procedure.

The target brix for most sugar flavors is between 13.5 and 15. The target brix for most “light” flavors will be lower, usually between 9 and 10. Check the specifications for the flavors if unsure of the target brix.

**Note:** Light or diet products have a low brix and can cause problems with the dispenser if not properly set up. Although these products contain ingredients that ensure the sugars freeze, they can still create excessive ice if not carefully brixed according to their specifications. Low brix issues will be associated with events such as audible ice scraping during freeze and low beater problems.





## 5.4 Filling Barrel and Starting

The barrel, or freeze chamber, must be purged of air before filling with product. Purge the air by activating the gas solenoid and then using the relief valve on the faceplate (**Figure 5.3**) to relieve air until all air has been displaced by gas\*. Failure to displace the air with gas will result in poor drink quality.

1	Navigate to the SERVICE MENU and then select the MAINTENANCE MENU. Go to the PURGE/FILL/DRAIN BARREL menu.
2	Highlight the desired barrel and then press the GAS PURGE button. Follow the prompts until the process has completed.
3	Press the FILL BARREL button to begin filling with product. Follow the prompts until the barrel is full (about 90% of the barrel) and then press the END button. Use the relief valve to relieve pressure in the barrel ( <b>Figure 5.3</b> ).
4	Once all barrels have been filled, return to the home menu.
5	Defrost the barrel(s) by pressing the green check mark button then selecting DEFROST. This will defrost the highlighted barrel and establish "baseline."
6	If you want to proceed to a freeze cycle right after the defrost cycle then press the green check mark button again and select ON.
7	When the LCD display shows READY, the barrel is ready to be conditioned. Dispense several drinks until lighter color product begins forming in the faceplate.

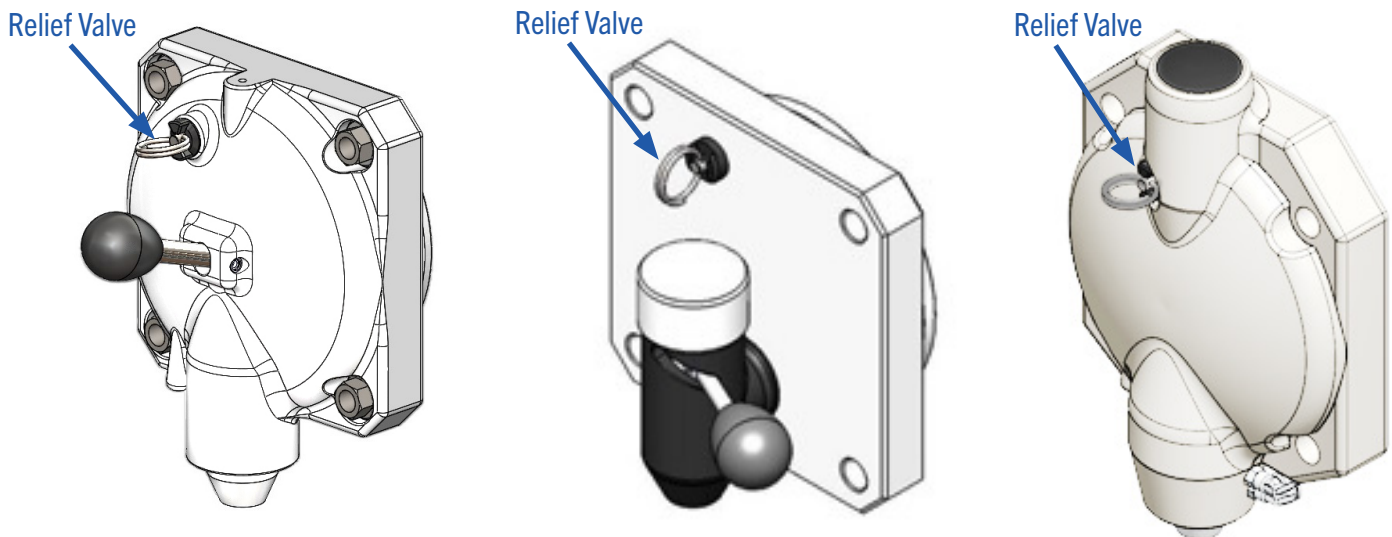


Figure 5.3 Relief Valve Location on Various Faceplate Types

\* Remember to deactivate gas solenoid upon completion.



## 6. DISPENSER OPERATION

### 6.1 Freeze

To freeze the product, press the up or down arrows on the keypad to select the desired barrel, then press the green check button and select ON. If the product is liquid, it will take four to ten minutes per barrel (depending on temperature of product) to complete the initial freeze cycle. Dispense drinks until product near faceplate lightens in color indicating the barrel is properly conditioned.

### 6.2 Off

There are two options for turning off the dispenser. The first is to turn off one barrel at a time. To turn off individual barrels, highlight the desired barrel in the home menu, then press the green check button and select OFF. Alternatively all barrels can be stopped by pressing the red hand button to the left of the screen and then confirming with the green check button.

### 6.3 Defrost

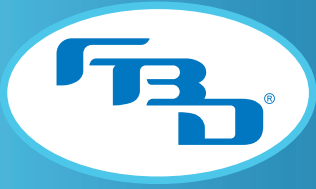
To maintain optimal drink quality, the product in the barrel must be periodically defrosted because ice crystals grow in size over time and degrade the consistency and texture of the drink. The best drink quality is always right after defrost and refreeze. Naturally, it is ideal for the dispenser to be ready to serve drinks at all times, so a balance between defrost and up time must be maintained. During times of high volume dispensing, a barrel can go longer without defrosting while low volume periods should defrost every three to four hours.

Most dispensers are configured to execute automatic defrosts to maintain optimal product quality (please refer to **Sections 7.13** and **7.14** for directions on setting up defrost times). If a defrost is required outside automatic set times either for drink quality or service, a manual defrost can be completed by highlighting the desired barrel in the home menu and using the green check button to select DEFROST. It will take about eight to twelve minutes to defrost (depending on the activity of the other barrels). Unless the barrel is stopped prior to initiating defrost, it will remain ON and a freeze cycle will begin after the completion of defrost.

### 6.4 Drink Quality

Many factors can affect the quality of a frozen beverage such as time since last defrost, brand of syrup used, and the local water quality. There can even be drink quality differences between the various flavors within a given brand. Because of these factors, the dispenser drink quality settings are designed to be easily adjusted to compensate for these natural differences or even to adjust the drink quality for personal preferences.

There are two settings that can be adjusted for each barrel to change drink quality: the FREEZE ADJUSTMENT, which controls the drink temperature, and the EXPANSION ADJUSTMENT, which controls how much gas is injected into the product. Both of these adjustments are electronic settings; therefore, no tools are required to make an adjustment (refer to **Section 7.10** for information on adjusting these settings). The type of adjustment will be determined based on the drink characteristic that needs to be changed. Please note that a barrel that has been idle for hours, such as overnight, will produce a wetter, heavier drink. It is best to dispense a few drinks to recondition the barrel. Consider the condition of the product in the barrel before making a judgment on the drink quality.



### 6.4.1 Drink Too “Firm” or Cold

A drink that is over-frozen will tend to be very cold, below 22°F (-5.5°C), and can be considered hard and difficult to suck through a straw. It can also be lighter in weight than a properly frozen drink and tends to collapse in the cup after being dispensed. To raise the temperature of the drink, increase the setting found in the FREEZE ADJUSTMENT menu. It will take several compressor cycles before the product in the barrel has reconditioned to the new setting.

### 6.4.2 Drink Too “Sloppy” or Warm

A drink that is not frozen enough will tend to be above 27°F (-2.8°C) and will be considered “wet” or “loose” and may not stand up in the cup. It can also be heavier in weight than a properly frozen drink. To freeze the drink harder, lower the setting in the FREEZE ADJUSTMENT menu. It will take several compressor cycles before the product in the barrel has reconditioned to the new setting.

### 6.4.3 Drink Too Heavy

A drink with not enough gas will be heavy and may look dark in the barrel. To increase the gas content in the drink, increase the setting in the EXPANSION ADJUSTMENT menu. Approximately ten 16 oz drinks will need to be dispensed before the product in the barrel is reconditioned to the new setting.

### 6.4.4 Drink Too Light

A drink with too much gas will be very light and may even collapse in the cup. To reduce the amount of gas in the drink, lower the setting in the EXPANSION ADJUSTMENT menu. Approximately ten 16 oz drinks will need to be dispensed before the product in the barrel is reconditioned to the new setting.



## 7. MENUS AND NAVIGATION

### 7.1 Keypad

The keypad is the user interface point and allows for control of the dispenser and navigation of the menus. Please review the keypad layout (Figure 7.1) to familiarize yourself with the interface.

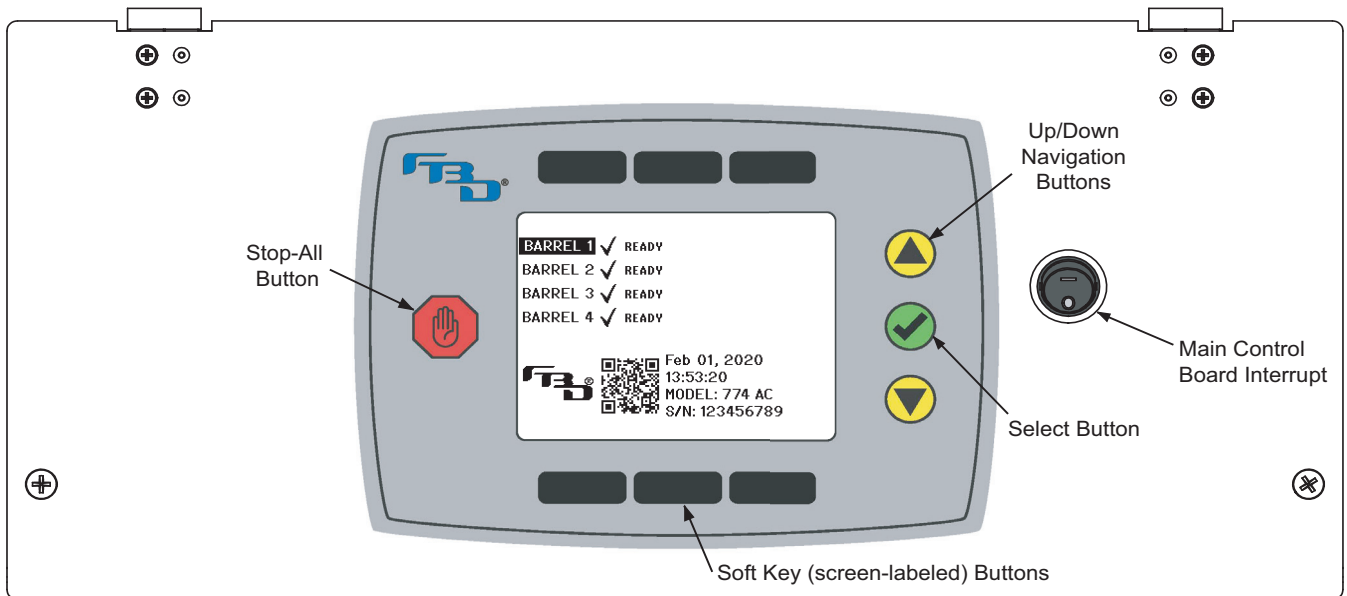
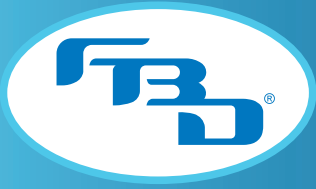


Figure 7.1 Keypad

- Select Button (green): This button confirms the current selection or action.
- Stop-All Button (red): This button will turn off all barrels. A confirmation by the green select button is required.
- Up/Down Arrow Buttons (yellow): These buttons move the selection cursor up and down. Press the select button to confirm the selection.
- Soft Key (screen-labeled) Buttons (black): These buttons change function depending on the menu currently being displayed. The function will be displayed below the top buttons and above the lower buttons.
- Main Control Board Interrupt: This switch controls power to the main control board. When OFF (○), the dispenser will remain powered, but the board will not. When ON (—), both the dispenser and board will be powered.

#### Screen Icon Legend

ICON	ACTION
	Returns the display to the home menu.
	Returns the display to the previous menu.
	Moves the selection cursor to the right.
	Moves the selection cursor to the left.



## 7.2 Home Menu

The home menu (Figure 7.1) shows the status of all barrels, allows control of all barrels, and is the launching point to the submenus. Press the green button while a barrel is highlighted to perform actions to that barrel such as defrost or turn on/off. Pressing the green arrow will also allow access to the submenus. Messages may appear on the home screen from time to time depending on the current activity or error. For a complete listing of these messages please see the “Home Menu Messages” section (Section 10.1).

## 7.3 Pop-Up Menu

The pop-up menu (Figures 7.2 and 7.3) allows the user to do the following:

- Start or stop the highlighted barrel.
- Defrost the highlighted barrel.
- Refill the highlighted barrel (use only when partially empty). Do not use this option to fill empty barrels, use the MAINTENANCE MENU instead.
- Perform a flavor change on the highlighted barrel.
- Proceed to the submenus.

The pop-up menu is accessed by pressing the green button when the home screen is displayed.

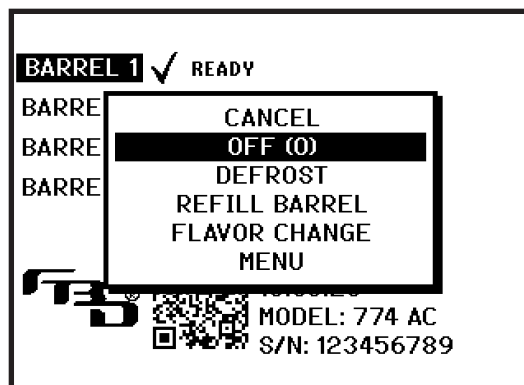


Figure 7.2

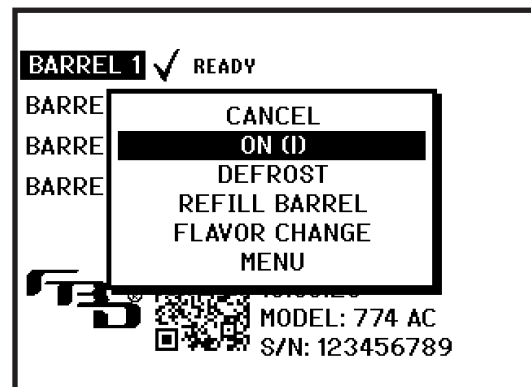
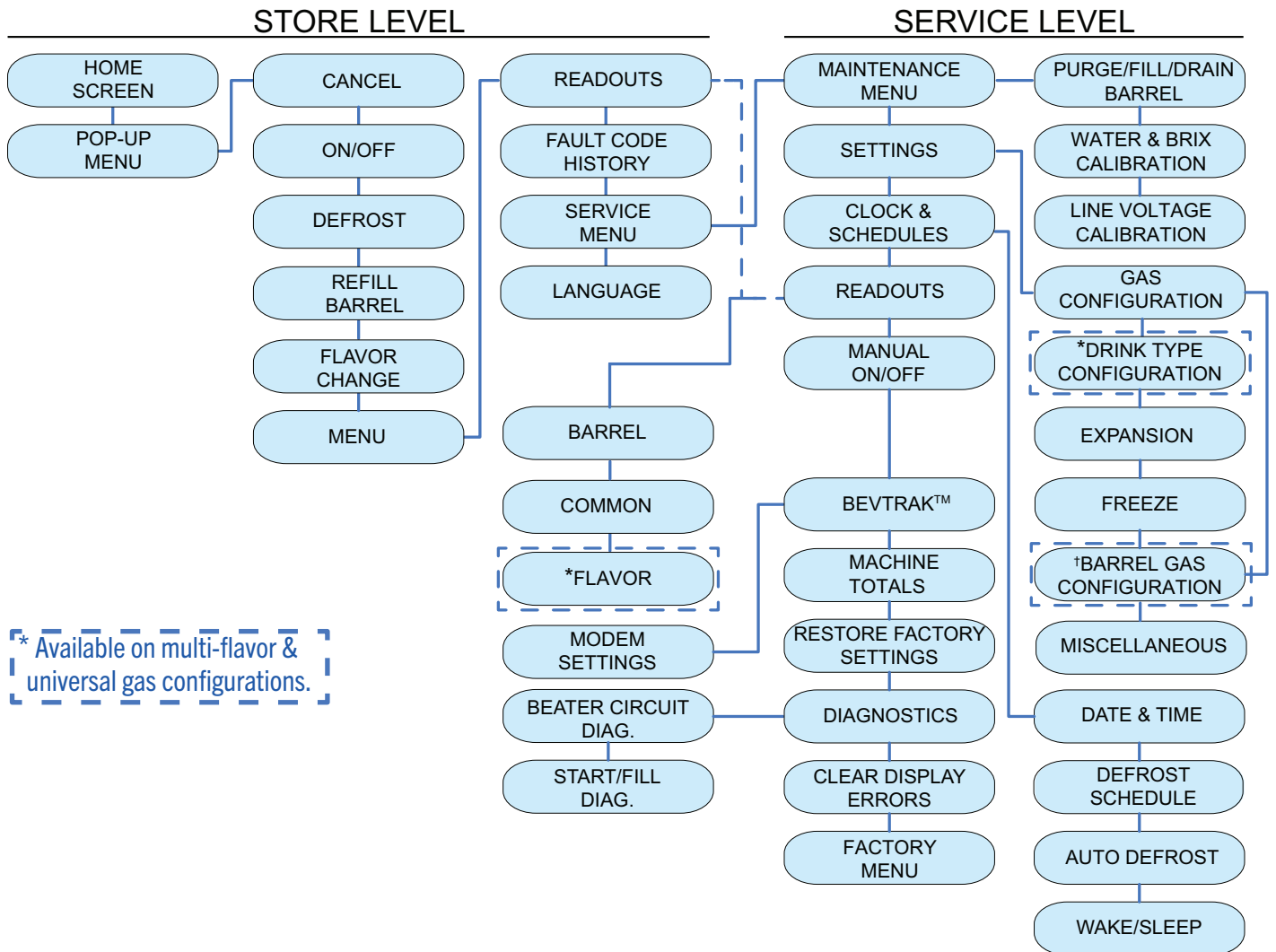


Figure 7.3



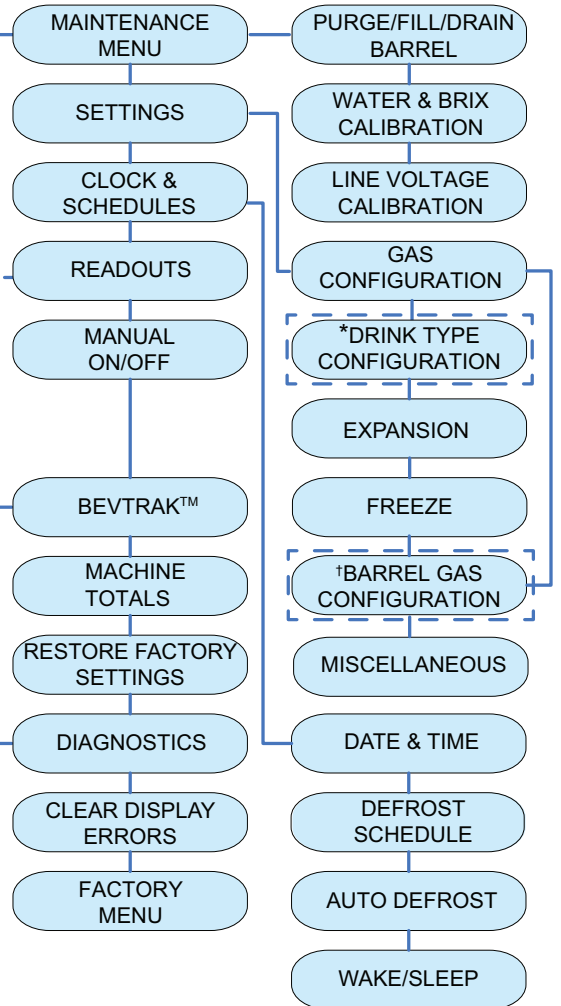
## 7.4 Menu Tree

The menu is divided up into two levels. The first level is the “store level” intended for the store operator. The second level is the “service level” intended only for trained service technicians. Below is a visual representation of the menu tree. For more information about each menu, see the sections that follow.

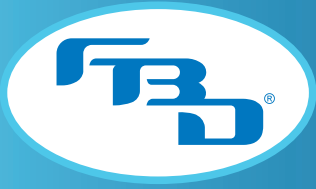


\* Available on multi-flavor & universal gas configurations.

## SERVICE LEVEL



To access the SERVICE MENU, highlight SERVICE MENU while in the MAIN MENU and then simultaneously press the green select key and the bottom center soft key.



## 7.5 Main Menu

The MAIN MENU (Figure 7.4) allows the user to:

- View the readouts (pressures, temperatures, etc).
- Access the fault code history.
- Access the SERVICE MENU.
- Set a language.

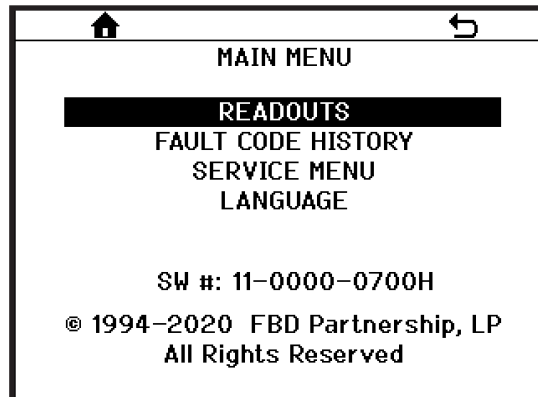


Figure 7.4

## 7.6 Readouts Menu

The READOUTS menu shows the current status of all temperature and pressure sensor readings, line voltage and other important information about the operation of the dispenser. Some readouts are common to the dispenser and others are side, or barrel, specific. Press the BARREL or COMMON soft key button to switch between the two readouts (Figures 7.5 and 7.6). For multi-flavor dispensers, there will also be a third menu that shows the FLAVOR readouts (Figure 7.7).

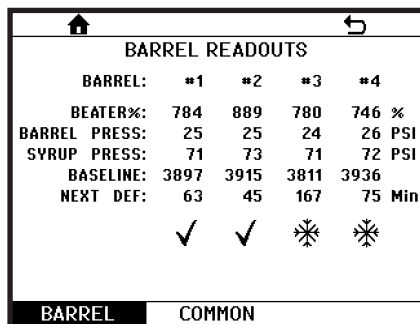


Figure 7.5

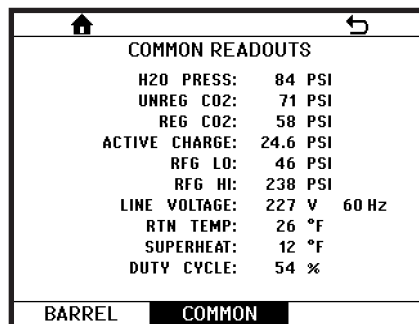


Figure 7.6

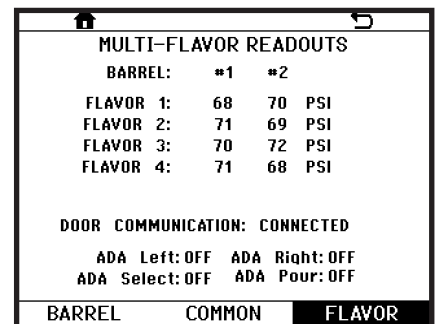


Figure 7.7



## 7.7 Fault Code History Menu

The FAULT CODE HISTORY menu provides a list of the last twenty fault codes with the date and time of occurrence and resolution (Figure 7.8). When the green button is pressed, additional details about the highlighted error are shown, including a QR code (Figure 7.9). Scan the QR code with a smart phone to see detailed troubleshooting steps. For a complete listing of fault codes that can be displayed please see the “Fault Codes” section (Section 10.2).

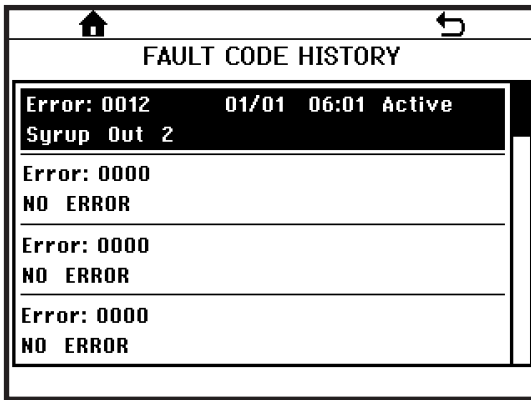


Figure 7.8

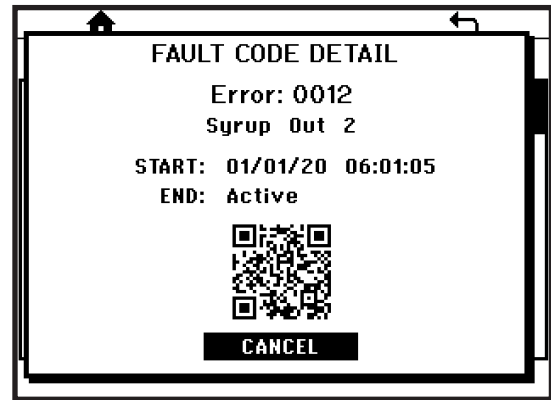


Figure 7.9

## 7.8 Service Menu

The SERVICE MENU options (Figure 7.10) are intended for use by a trained service technician only. To access these submenus, select SERVICE MENU while in the MAIN MENU and then press the green check button and the bottom center soft key button (blank) simultaneously.

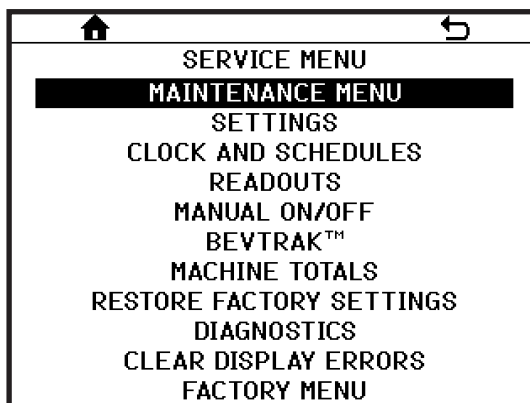
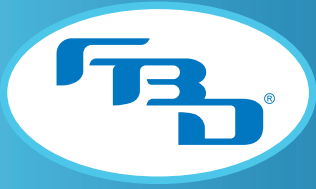


Figure 7.10



## 7.9 Maintenance Menu

The MAINTENANCE MENU has three sections to choose from (Figure 7.11): PURGE/FILL/DRAIN BARREL, WATER AND BRIX CALIBRATION, and LINE VOLTAGE CALIBRATION.

**PURGE/FILL/DRAIN BARREL (Figure 7.12)** – Provides three semi-automatic routines that eliminate the need to manually turn solenoids on and off. Follow the on-screen prompts to complete each process. All processes may be terminated at any time by pressing the END button.

- **GAS PURGE:** This procedure must be used after the faceplate has been removed and there is air in the barrel. It will purge the air from the barrel and replace it with gas. Use this process before filling the barrel. If the air is not replaced with gas, then the drink quality of the first few drinks from the barrel will be negatively affected. The process will fill the barrel with gas three times before automatically ending.
- **DRAIN BARREL:** This process will assist in draining liquid from a barrel (defrost first if needed). The user must terminate this process by pressing the END button once the barrel is empty.
- **FILL BARREL:** This process fills the barrel with product. The user must terminate this process by pressing the END button once the barrel is full.

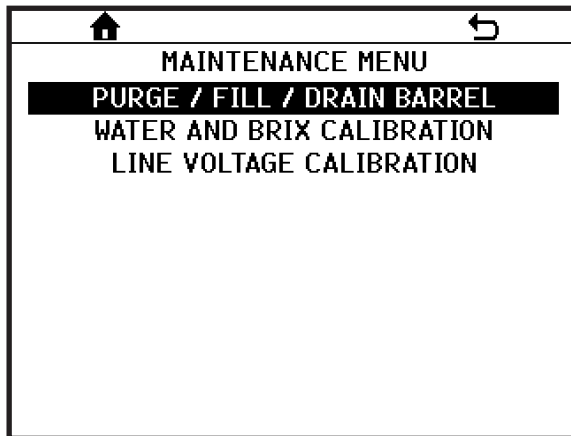


Figure 7.11

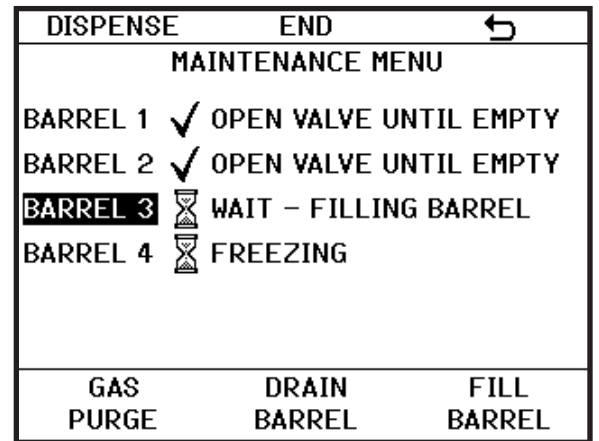


Figure 7.12



WATER AND BRIX CALIBRATION (Figure 7.13) – Provides a step-by-step process for calibrating the flow controls for the solution modules. Images and instructions are provided in each step.

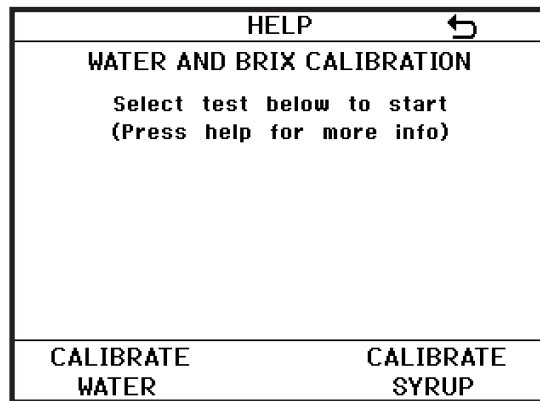


Figure 7.13

LINE VOLTAGE CALIBRATION (Figure 7.14) – Calculates the voltage offset. To use this function, first measure the line voltage on the contactor with a voltmeter, then enter that value into the menu. Once entered, the dispenser will calculate the voltage offset and correct the readout in the READOUTS menu.

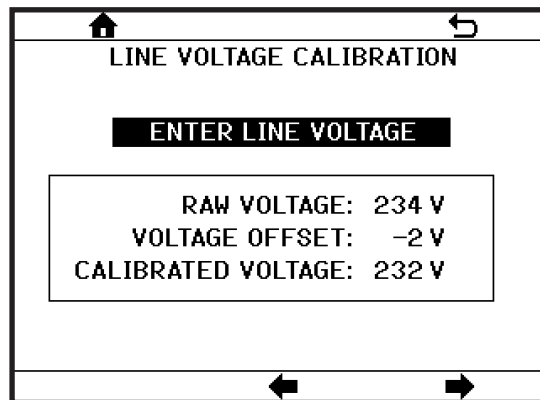
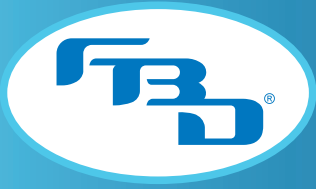


Figure 7.14



## 7.10 Settings Menu

The SETTINGS menu (Figures 7.15 and 7.16) provides dispenser information and access to some settings that are adjustable. Available settings options change based on dispenser software.

- **SERIAL #:** Set the serial number of the dispenser (this is used for BevTrak™ reporting).
- **BARRELS:** Provides the number of barrels for the dispenser.
- **DISPLAY UNITS:** Set the units of measurement to IMPERIAL or METRIC.
- **ACTIVE CHARGE:** Enabled for dispensers with Dynamic Charge Control (DCC).
- **REFRIGERANT:** Displays the refrigerant—R404-A or R448-A—the dispenser is using.
- **CONDENSER TYPE:** Displays type of refrigeration for dispenser (LOCAL AIR, REMOTE AIR, WATER-COOLED).
- **BEATER ALWAYS ON:** For dispensers with the energy savings option to turn off motors intermittently, this setting, if ENABLED, allows for beater motors to remain on at all times.

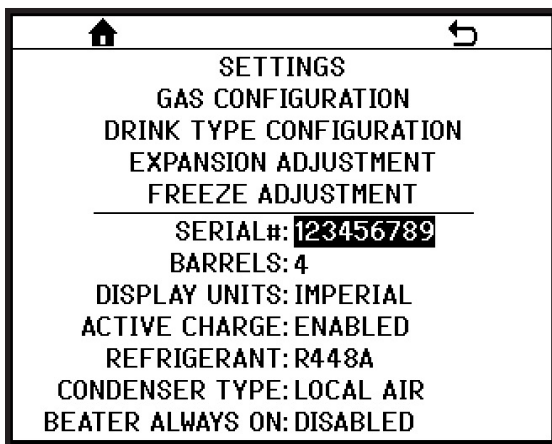


Figure 7.15

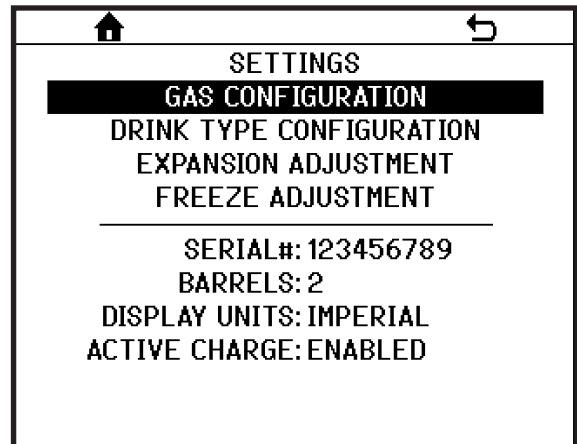


Figure 7.16

There are also four additional submenus that can be updated/set-up, based on dispenser model, to adjust different drink characteristics.

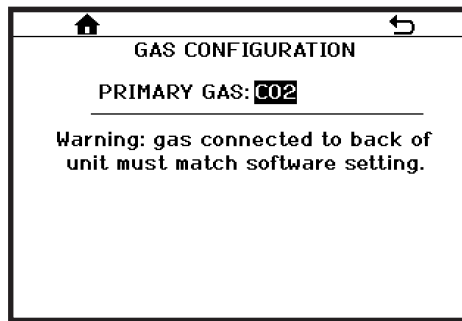
- **GAS CONFIGURATION:** Used to display and, based on dispenser model, select the gas that will be used in the dispenser (Figures 7.17 and 7.18).
- **DRINK TYPE CONFIGURATION:** Used to configure the drink type (medium or high expansion) based on selected gas (Figure 7.19). Settings will only be available on dispensers with multi-gas, multi-flavor functionality.
- **EXPANSION ADJUSTMENT:** Used to adjust the amount of gas in a drink (Figure 7.20). The range of values is limited based on the configured gas and drink type.
- **FREEZE ADJUSTMENT:** Used to adjust drink temperature or how frozen the drink is (Figure 7.21).



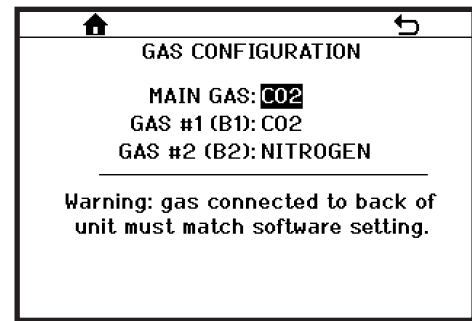
**GAS CONFIGURATION:**

- For standard dispensers with no multi-gas or multi-drink functionality (**Figure 7.17**) this menu displays the gas (CO2 or NITROGEN; determined by dispenser configuration) that is injected into the barrels and that operates the water pump and active charge system.
- For universal gas dispensers, this menu allows the user to set the gas used for MAIN GAS, GAS #1, and GAS #2 (**Figure 7.18**). The options for MAIN GAS are COMP AIR (compressed air), CO2, or NITROGEN. The options for GAS #1 and GAS #2 are CO2 or NITROGEN. Ensure the correct gas is selected in this menu (**Figure 7.19**) to avoid issues with the drink profile.

If the gas connections are being combined into one gas connection using adapter sets (sold separately), then the selected gas needs to be the same for the gas connections being combined.

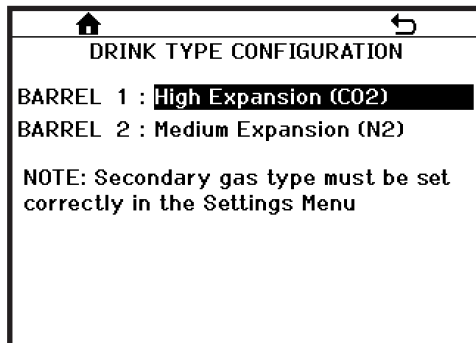


**Figure 7.17**



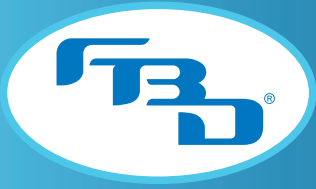
**Figure 7.18**

**DRINK TYPE CONFIGURATION (Figure 7.19)** - Once the gas type has been set under GAS CONFIGURATION, the drink type will need to be configured for universal configurations. Since the type of drink available for any given barrel is dependent on the gas that was selected for the barrel, it is very important to make sure the correct gas is selected. The available drink types will also vary by dispenser configuration as shown in the Universal Configuration Drink Types table.



**Figure 7.19**

Universal Configuration Drink Types	
Dispenser	Available Drink Types
771 Multi-Flavor	CO2: Medium Expansion and High Expansion N2: Medium Expansion
772 Multi-Flavor	CO2: Medium Expansion and High Expansion N2: Medium Expansion



**EXPANSION ADJUSTMENT (Figure 7.20)** - This menu allows the user to set how much gas is injected into the drink. The adjustment ranges from “MAX” (high levels of gas, high expansion) to “LESS” (lower levels of gas, low expansion). Select the barrel number and adjust the level up or down.

Approximately ten 16 oz drinks will need to be dispensed before the product in the barrel has reconditioned to the new settings.

**Note:** The range of values is limited based on the configured gas and drink type.

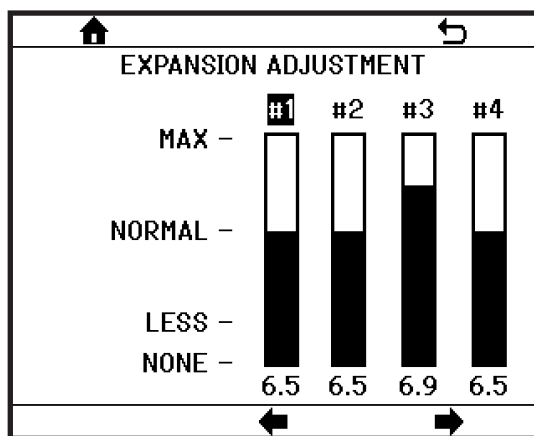


Figure 7.20

**FREEZE ADJUSTMENT (Figure 7.21)** - Allows the user to make the drink more liquid or more frozen.

**Note:** It will take several compressor cycles before the product in the barrel has reconditioned to the new settings.

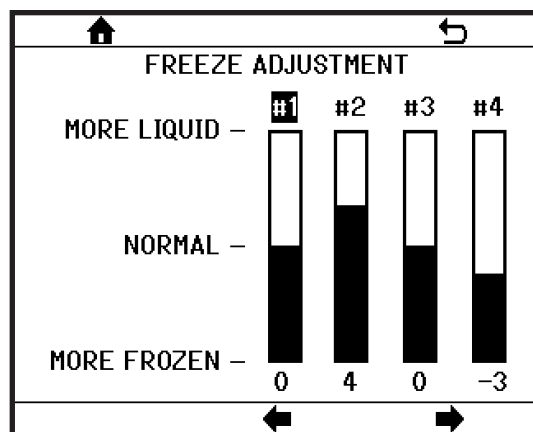
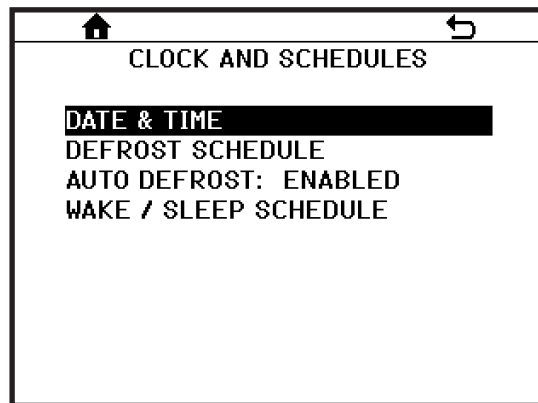


Figure 7.21



## 7.11 Clock and Schedule Menu

The CLOCK AND SCHEDULE menu contains various submenus shown in [Figure 7.22](#).

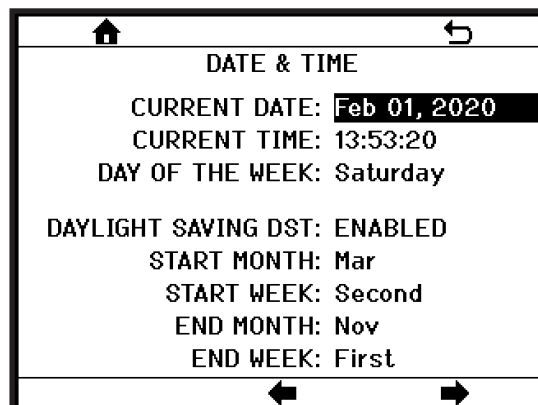


[Figure 7.22](#)

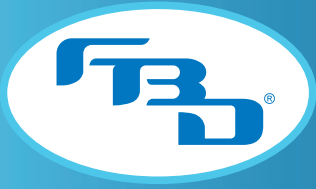
## 7.12 Date and Time Menu

The dispenser date and time is set in this menu. The time is in 24 hour format. The Daylight Saving Time (DST) feature can also be activated and the start and end dates are adjustable. Refer to your country's specific DST schedule to set the start and end dates.

For example: In the USA, DST begins the second Sunday in March and ends on the first Sunday in November. The example in [Figure 7.23](#) shows DST has been set according to this schedule.



[Figure 7.23](#)



## 7.13 Defrost Schedule Menu

The defrost schedule menu (Figure 7.24) allows the user to set the defrost times for all barrels. The user sets the time for barrel #1 and then sets the delay time between additional barrels. For example, on a four barrel dispenser the delay time is set to 60 minutes and the first defrost is at 03:00. Barrel #1 will defrost at 03:00, barrel #2 will defrost at 04:00, barrel #3 at 05:00, and barrel #4 at 06:00. Up to eight defrosts can be scheduled per barrel per day. A time of 00:00 means no defrost is scheduled.

Each defrost time also has a day of the week setting. If the day of the week is capitalized then the dispenser will defrost at that time on that day. If the day of the week is lowercase then the dispenser will skip that defrost time on that day.

There are also predefined defrost schedules available. Contact FBD for details on the various schedules.

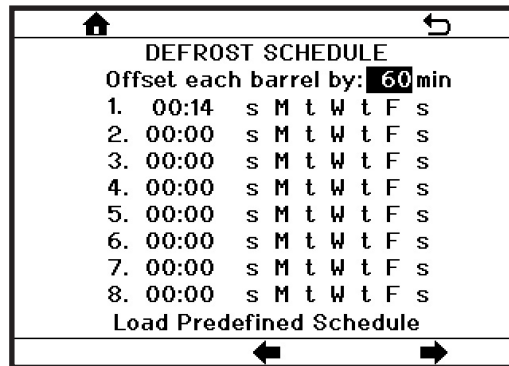


Figure 7.24

## 7.14 Auto Defrost Menu

In addition to a preset defrost schedule, the dispenser has an automatic defrost feature (Figure 7.25). This allows the dispenser to dynamically adjust the time between defrost cycles based on customer activity.

When the auto defrost feature is enabled there are also “black out windows” that can be programmed. These windows prevent any defrost cycles from occurring during that period. Up to three windows can be specified and the start and end times for each window must be designated.

**Note:** A defrost schedule and auto defrost can be used simultaneously. Note, any time that the barrel is defrosted and then frozen, the auto-defrost timer is reset.

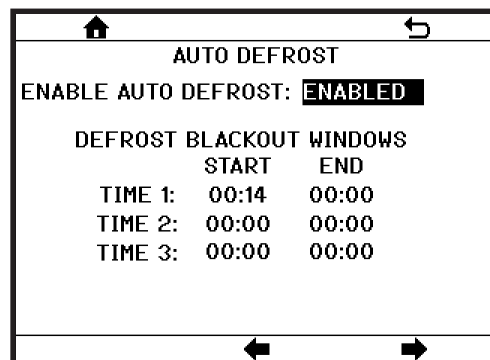


Figure 7.25



## 7.15 Wake/Sleep Schedule Menu

The wake/sleep feature (Figure 7.26) makes the dispenser wake up and go to sleep automatically. This feature is useful for locations that are closed overnight. The wake and sleep times can be different for each day of the week or common for all days.

WAKE / SLEEP SCHEDULE		
	Wake	Sleep
Every Day	00:00	00:00
Sunday	00:00	00:00
Monday	00:00	00:00
Tuesday	00:00	00:00
Wednesday	00:00	00:00
Thursday	00:00	00:00
Friday	00:00	00:00
Saturday	00:00	00:00

Figure 7.26

## 7.16 Manual On/Off Menu

The MANUAL ON/OFF (or MACHINE ON/OFF) menu (Figures 7.27 and 7.28) allows the service technician to turn on and off any solenoid, motor or status light in the dispenser. This is useful when purging the barrels or troubleshooting the dispenser.

**Note:** For protection, all solenoids will automatically turn off after 6 minutes.

For multi-flavor dispensers, there is also a MULTI-FLAVOR ON/OFF menu (Figure 7.29) to turn on and off the flavor solenoids.

MACHINE ON/OFF				
Beater Motor:	OFF	ON	OFF	OFF
Gas Sol:	OFF	OFF	OFF	OFF
Solution Sol:	ON	OFF	OFF	OFF
Defrost Sol:	OFF	OFF	OFF	OFF
Expansion Sol:	OFF	OFF	OFF	OFF
Ready Light:	OFF	OFF	OFF	OFF
Not Ready Light:	OFF	OFF	OFF	OFF
Product Out Light:	OFF	OFF	OFF	OFF
Defrost Light:	OFF	OFF	OFF	OFF
Sold Out Light:	OFF	OFF	OFF	OFF
COMPRESSOR:	ON		FAN:	OFF

Figure 7.27 Non-DCC\* Units

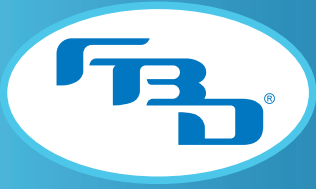
Beater Motor:	OFF	ON	OFF	OFF
Gas Sol:	OFF	OFF	OFF	OFF
Solution Sol:	ON	OFF	OFF	OFF
Defrost Sol:	OFF	OFF	OFF	OFF
Expansion Sol:	OFF	OFF	OFF	OFF
Ready Light:	OFF	OFF	OFF	OFF
Not Ready Light:	OFF	OFF	OFF	OFF
Product Out Light:	OFF	OFF	OFF	OFF
Defrost Light:	OFF	OFF	OFF	OFF
Sold Out Light:	OFF	OFF	OFF	OFF
COMPRESSOR:	ON		FAN:	OFF
DCC FILL:	OFF		DCC VENT:	OFF

Figure 7.28 DCC\* Units

MULTI-FLAVOR ON/OFF		
Barrel:	#1	#2
Flavor 1 Sol:	OFF	OFF
Flavor 2 Sol:	OFF	OFF
Flavor 3 Sol:	OFF	OFF
Flavor 4 Sol:	OFF	OFF
Dispense Sol:	OFF	OFF
COMMON		

Figure 7.29

\* DCC - Dynamic Charge Control



## 7.17 BevTrak™ Menu

BevTrak™ is a reporting system for FBD beverage equipment. It allows the equipment owner to monitor the status and sales performance of their dispenser on the internet. BevTrak™ connects to the internet via Wi-Fi. If the dispenser comes with BevTrak™ capability, the BEVTRAK™ menu (Figure 7.30) will show “Yes” for Enabled. Enter the dispenser serial number (if not already entered) in this menu to utilize BevTrak™. Also a Wi-Fi modem will need to be set up (refer to Section 7.18) and a customer login portal will need to be created on the BevTrak™ website ([www.bevtrak.com](http://www.bevtrak.com)). Contact FBD sales for assistance in setting up an account.

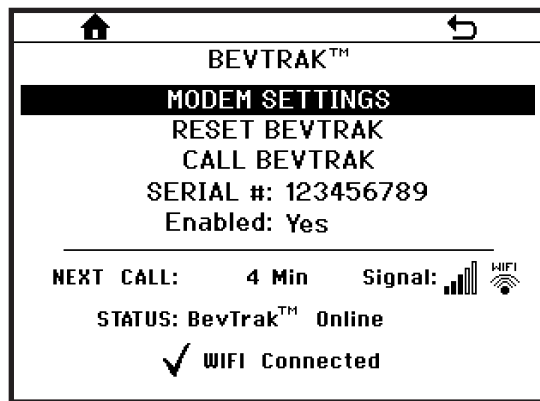


Figure 7.30

## 7.18 Modem Settings Menu

The Wi-Fi modem must be configured before BevTrak™ can be used. To configure the modem, from the MODEM SETTINGS menu (Figure 7.31), select CONFIGURE WIFI. This will open a WIFI SETUP MENU (Figure 7.32) that will list networks in the area. Select from the list or manually enter the network information. Once the network is selected, a second WIFI SETUP MENU window will appear (Figure 7.33) so the password and security settings can be entered. Select PRESS TO COMPLETE SETUP to complete the process.

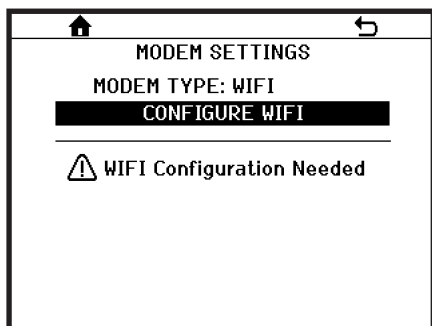


Figure 7.31

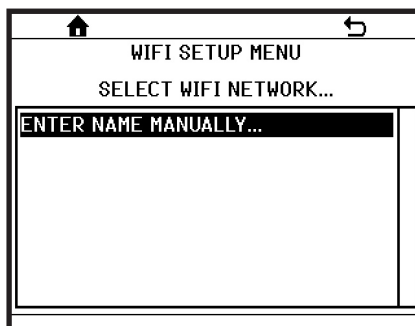


Figure 7.32



Figure 7.33



## 7.19 Machine Totals Menu

77X software records data while the dispenser operates. The MACHINE TOTALS menu (Figure 7.34) displays this data (such as the number of compressor cycles or operating time for various components) which can be useful when evaluating dispenser performance or identifying dispenser errors.

MACHINE TOTALS				
BARREL:	#1	#2	#3	#4
DEFROST:	2,365	2,001	2,445	2,364 Cyc
SOLDOUT:	435	19	336	398 Hrs
BEATER:	72	73	72	68 Hrs
RUN-ON:	69	66	70	60 Hrs
ERROR:	4	2	5	10 Hrs
SYRUP:	122	300	97	153 Min
COMPRESSOR HOURS:	22 Hrs			
COMPRESSOR CYCLES:	672 Cyc.			
POWER ON HOURS:	109 Hrs			
SLEEP HOURS:	0 Hrs			
<b>RESET TOTALS</b>				

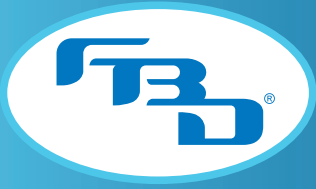
Figure 7.34

## 7.20 Restore Factory Settings Menu

The RESTORE FACTORY SETTINGS menu (Figure 7.35) allows a service technician to restore the dispenser settings to factory default. When restoring factory settings, certain settings can be retained such as the defrost schedule, auto-defrost-blackout times, language and units (Imperial or Metric). Select which settings are to be retained before restoring the factory settings.

RESTORE FACTORY SETTINGS	
<b>RETAIN SETTINGS:</b>	
DEFROST SCHEDULE:	No
BLACKOUT TIMES:	No
LANGUAGE:	No
UNITS:	No
<b>LOAD FACTORY DEFAULTS</b>	

Figure 7.35



## 7.21 Diagnostics Menu

The DIAGNOSTICS MENU (Figure 7.36) is a powerful feature of the 77X dispensers. Any time a malfunction is suspected, the best option for the service technician is to first run the diagnostic sequence for the system involved. This can eliminate hours of guesswork and parts swapping.

There are two diagnostic sequences:

- Beater Circuit: This sequence will help identify any component failures in the beater circuit system such as the beater motor and capacitors.
- Fill Circuit: This sequence will help identify any component failure in the fill circuit system such as solution or gas solenoids or any leaks in the product delivery system.

To begin, determine what the possible issue with the dispenser may be. Select the appropriate diagnostic sequence. Initiate the sequence and let it perform its checks. You may be asked to perform some manual operations or answer questions to proceed with the process. If any errors are found, the display will note the error and provide an error code. Refer to the “Diagnostic Fault Codes” section (Section 10.3) to diagnose the cause of the error.



Figure 7.36



## 8. CLEANING AND SANITIZING

### 8.1 General Information

The dispensers are shipped from the factory cleaned and sanitized in accordance with NSF guidelines. After installation of the dispenser, the operator must provide continuous maintenance as described in this manual and always adhere to state and local codes to ensure proper operational and sanitation requirements are met. Failure to properly clean and sanitize the dispenser can negatively affect components, drink quality, and dispenser operation. FBD recommends that the dispenser be sanitized annually or when the dispenser has been non-operational for an extended period of time.

A few precautions when cleaning:

- To avoid contamination, **DO NOT** disconnect water lines during the cleaning and sanitizing process.
- **DO NOT** use strong bleaches or detergents when cleaning the exterior of the equipment. They will discolor and possibly corrode various materials.
- **DO NOT** use metal scrapers, sharp objects, steel wool, scouring pads, abrasives, solvents, etc., on the dispenser as they can damage the finish on various materials.

### 8.2 Daily Cleaning

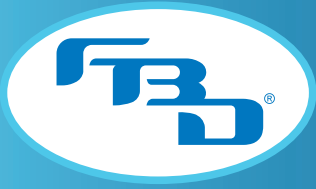
A mild soap solution such as hand dishwashing detergent diluted with water at 90°F to 100°F (32°C to 38°C) should be used to clean the exterior of the equipment. Remove all product residues from the surfaces of the dispenser. Rinse thoroughly using clean water also at 90°F to 100°F (32°C to 38°C) to remove the remaining soap. Remove the drip tray (if not connected to drain plumbing) and cup rest to clean in a sink using a mild soap solution.

### 8.3 Sanitizing

The dispenser should be sanitized yearly. Prepare a chlorine solution containing 100 PPM of available chlorine with clean water at 90°F to 100°F (32°C to 38°C). Commercial beverage equipment sanitizing and cleaning solutions such as Kay-5 or Stera Sheen Green Label are preferred because they also contain surfactants to assist in cleaning. If using a commercial sanitizer/cleaner such as this then prepare according to their directions.

The following procedure must be followed for sanitizing the dispenser in accordance with NSF guidelines. The following process describes the procedure for one barrel. Repeat for all barrels.

1	On the home screen press the up or down arrow until the barrel to be sanitized is highlighted. Press the green button and then select OFF. Press the green button again and select DEFROST.
2	While the barrel is defrosting, remove the drip tray (if not connected to drain plumbing), splash plate, and the cover located behind the splash plate.
3	Take an empty BIB and cut off the connector to make an adapter. Attach the BIB connector (adapter) to the connector on the syrup line - this will open up the syrup line connector and allow for cleaning solution to be pumped into the dispenser.



## 77X INSTALLATION & OPERATION MANUAL 771/772/773/774 MODELS

4	Once the barrel has defrosted, navigate to the MANUAL ON/OFF menu located in the SERVICE MENU section and activate both the gas and solution solenoids for the barrel to be sanitized.
5	Place a large container under the dispensing valve and drain the barrel. Activating the beater motor will facilitate draining the barrel when near empty. Deactivate the solution solenoid when the syrup lines have been purged. Continue purging the barrel and then deactivate the gas solenoid when the barrel has been emptied.
6	Turn off the water supply at the solution module using the shutoff valve.
7	Place the syrup BIB connector with adapter in the sanitizing solution.
8	Activate the solution solenoid and begin filling the barrel with sanitizing solution. Pull the relief valve as necessary to vent the pressure allowing the fill process to continue. Deactivate the solution solenoid when the barrel is 3/4 full.
9	Activate the beater motor and agitate for three minutes.
10	While the beater motor is agitating, dispense some sanitizing solution from both the relief valve and the sample valve to ensure they are both sanitized as well.
11	Remove the BIB connector from the sanitizing solution and reconnect to the syrup supply.
12	Activate the solution solenoid.
13	Place a large container under the dispensing valve and drain the barrel. Activating the beater motor will facilitate draining the barrel. Deactivate the solution solenoid when the syrup lines have been primed with syrup. Continue purging the barrel and then deactivate the gas solenoid when the barrel has been emptied.
14	Restore the water supply.
15	Activate the solution solenoid and beater motor again. When the barrel is 1/2 full, deactivate the solution solenoid to stop the fill process.
16	Activate the gas solenoid and drain the barrel. This step removes the remaining sanitizing solution left in the barrel. Deactivate the gas solenoid and beater motor when the barrel is empty.
17	Navigate to the MAINTENANCE MENU and start the FILL BARREL process. Follow the prompts until the barrel is full.
18	If any sanitizer off-taste remains, drain the barrel again and refill.

For multi-flavor dispensers, the process on sanitizing the syrup lines will need to be followed for both the base syrup lines and the flavor syrup lines. For the flavor syrup lines, make sure to manually activate each solenoid for the flavor syrup modules to run the cleaning fluid through the lines. Once the lines are sanitized, they will need to be attached to their syrup BIBS and the cleaning fluid purged until each line connected to the faceplate is full of syrup.



## 9. PREVENTIVE MAINTENANCE

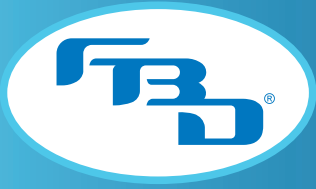
An annual preventive maintenance schedule is recommended by FBD and should include the following steps:

A.	Check the Fault Code History in the menu ( <b>Section 7.7</b> ). If there are repeated beater low errors, inspect blades for damage (chips, cracks, warping, excessive wear) and dullness. The blade edge should be sharp and smooth. If damage or dullness is found, replace blades using an FBD blade/spring kit.
B.	Verify time, date, sleep, and defrost settings ( <b>Section 7.11</b> ). Adjust as necessary.
C.	Clean air filter ( <b>Section 9.1</b> ).
D.	Check all fittings and components for leaks. Repair if necessary.
E.	Check O-ring seals in dispenser valves for leakage and wear. Replace as necessary.  For dispensers using the stainless-steel DDV, the roll pin needs to be changed during the annual preventive maintenance. The SS DDV Minor Repair Kit (P/N 12-1140-0001) contains the roll pin and O-rings that are recommended to be replaced. If the internal metal components show signs of wear, the SS DDV Major Repair Kit (P/N 12-2307-0001) can be used to replace needed components. If the roll pin does not fit tightly with the handle lever, replace the handle (P/N 12-2864-0012).
F.	Replace the motor rear seals (Section 9.2).
G.	Sanitize according to manufacturer's recommended procedure (Section 8.3).
H.	Check water flow rate and brix (Section 5.3).

### 9.1 Air Filter Cleaning

The air filter must be cleaned monthly to ensure proper operation of the dispenser. A dirty air filter will reduce the refrigeration capacity and can potentially damage the compressor. To remove the filter, open the front merchandiser and locate the filter above the LCD display. Pull the air filter straight out to remove. Clean it with a mild dishwashing soap and water solution and dry thoroughly before reinstalling. A degreaser may be required if the filter is greasy.

**NOTE:** If the dispenser is located in a particularly dusty area or with airborne grease such as the cooking area of a fast food restaurant, the filter should be cleaned every two weeks.



## 9.2 Rear Seal Replacement

The motor rear seals must be replaced annually. Failure to do so will result in rear seal leaks and potential motor failures. If the dispenser has been in storage for longer than 90 days, FBD recommends that the rear seals be replaced. The rear seal can be replaced from the front of the dispenser. The barrel must be drained and the faceplate removed to access the seal. The following process describes the procedure for one barrel. Repeat for all barrels.

1	On the home screen, press the up or down arrow until the barrel to be serviced is highlighted. Press the green button and then select OFF. Press the green button again and select DEFROST.
2	After the defrost cycle is complete, navigate to the MAINTENANCE MENU and start the DRAIN BARREL process. Follow the prompts until the barrel is empty and then end the process.
3	Vent the barrel of all pressure.
4	Remove the faceplate and beater bar. Be sure to catch the remaining liquid from the barrel when removing the faceplate.
5	With a small pick or corkscrew type seal puller, reach into the back of the barrel and remove the rear seal ( <b>Figure 9.1</b> ). Discard the used seal.
6	Lubricate the inner diameter on the new seal with Dow Corning 111 lubricant or any other NSF approved lubricant for food contact. <ul style="list-style-type: none"><li>• DO NOT lubricate the outer diameter of the seal.</li><li>• DO NOT use a hydrocarbon based lubricant as swelling and premature seal failure will occur.</li></ul>
7	Reinstall the seal with the "V" groove facing the product chamber. Ensure the rear seal is firmly seated by checking to make sure it is flush with the back of the barrel.
8	Reinstall the beater bar and faceplate. <b>Note:</b> FBD recommends sanitizing the barrel (see <b>Section 8.3</b> ) before filling.
9	Return to the MAINTENANCE MENU and start the GAS PURGE process followed by the FILL BARREL process.

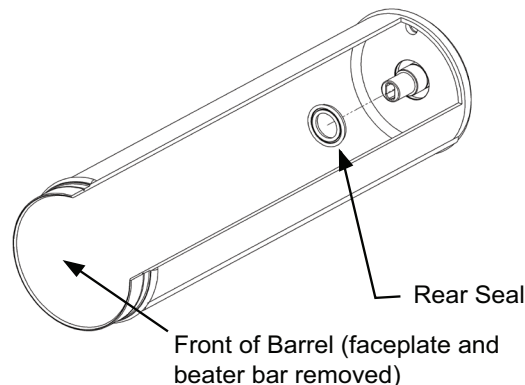
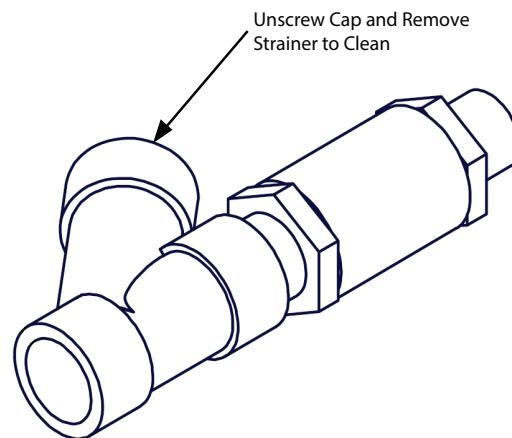


Figure 9.1 Rear Seal Placement



## 9.3 Backflow Preventer Maintenance

The strainer portion of the backflow preventer must be removed and cleaned on an annual basis. To clean the device, turn off the water supply and unscrew the filter housing (**Figure 9.2**). Clean any debris and replace the strainer. Turn the water supply back on when finished.



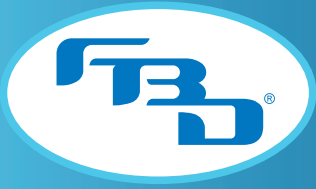
**Figure 9.2 Backflow Preventer**

## 9.4 Servicing the Product Tray

If the dispenser was installed following **Section 4.3** (Installation for Easier Service) of this manual, then use the following steps for servicing the product tray:

- Remove the drip tray (if not connected to drain plumbing), splash plate, and fluid control cover to expose the product tray.
- Remove the two nuts holding the product tray down using a 7/16" socket or nut driver.
- Remove the ties taking up the slack in the wiring harnesses.
- Lift up on the tray and pull out. Depending on the desired tray extraction distance some of the pressure transducers & solution solenoids may need to be disconnected.\*
- Service the tray.
- Reassemble the dispenser in reverse order.

\*For multi-flavor dispensers, pull out the tray about 4" and disconnect the pressure transducers, any electrical connections, as well as the faceplate activation tubing and the flavor hoses before completely pulling out the tray to service.



## 10. TROUBLESHOOTING

### 10.1 Home Menu Messages

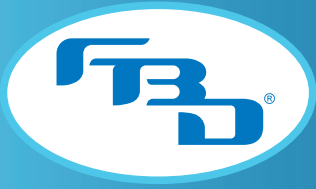
The dispenser will always display a message on the home screen with the status of the dispenser. These may be normal operation messages, depleted supply messages or error messages.

Message	Meaning	Action
AIR OUT	Dispenser not receiving compressed air.	Restore supply of compressed air. Dispenser will automatically restart.
CO2 OUT	CO2 supply depleted.	Restore CO2 supply. Dispenser will automatically restart.
DEFROST PAUSED	Defrost cycle was paused because another barrel required freezing.	No action required.
DEFROST REQUIRED	Motor baseline value is at factory default. Only occurs on new software installation.	Run defrost cycle.
DEFROSTING	Barrel is defrosting.	Wait for defrost cycle to complete.
FILL ERROR	A barrel is not filling with product correctly.	Run fill circuit diagnostic sequence.
FREEZING	Dispenser is in READY mode and product is being frozen.	No action required.
HIGH BARREL PRESSURE	The barrel pressure exceeds 55 PSI (379 kPa).	Dispense a drink to reduce barrel pressure.
MOTOR FAILURE	A beater motor is stalled.	Run the beater circuit diagnostic sequence.
NITROGEN OUT	Nitrogen supply depleted.	Restore nitrogen supply. Dispenser will automatically restart.
OFF	Barrel is turned off.	Select the ON option in the pop-up menu.
READY	Barrel is ready for serving.	Enjoy a frozen beverage.
SLEEPING	Dispenser is in sleep mode.	Wait until the normal wake time or restart each barrel by turning ON.
SYRUP OUT	The syrup pressure is below the syrup out threshold.	Check syrup BIB or pump. Replace BIB, if needed (barrel will automatically restart).
WAITING TO DEFROST	Barrel is waiting to begin the defrost cycle and must wait until another barrel freezes or completes a defrost.	No action required.

Table continued on next page.



<b>Message</b>	<b>Meaning</b>	<b>Action</b>
WAITING TO FREEZE	Barrel is ready to freeze but is waiting on other barrel(s) to complete defrost.	Wait until other barrel(s) have completed the defrost cycle.
WATER OUT	Water supply turned off.	Restore water supply. Dispenser will automatically restart.



## 10.2 Fault Codes

The dispenser records all errors, or faults, that occur. A history of these faults can be found in the **FAULT CODE HISTORY** menu located in the **SERVICE MENU**. Each error has a three-digit number associated with it. The first two digits are the error number and the third digit indicates the barrel number with the error. If the third digit is a 0 (zero) then the error is a common error to all barrels or it is a dispenser error.

### **Error #011, 012, 013, 014: Syrup Out**

The syrup pressure is less than 45 PSI (310 kPa). For multi-flavor dispensers, this is the base syrup.

1	Replace the empty BIB.
2	Ensure the gas line is connected to the BIB pump.
3	Ensure the BIB pump is operating correctly.
4	Ensure the gas tank is not empty.
5	Ensure the syrup shutoff valve at the solution module is turned on.
6	Ensure any syrup shutoff valves at the back of the dispenser are not turned off.
7	Ensure the syrup supply pressure at the dispenser is reading 70 PSI (483 kPa). Adjust the regulator if needed.
8	Ensure the syrup pressure transducer is connected and working properly.

### **Error #020: CO<sub>2</sub> Out**

The CO<sub>2</sub> pressure is less than 45 PSI (310 kPa).

1	Replace or refill the CO <sub>2</sub> tank.
2	Ensure the CO <sub>2</sub> shutoff valve at the back of the dispenser is not turned off.
3	Ensure the CO <sub>2</sub> pressure transducer is connected and working properly.
4	Ensure the CO <sub>2</sub> supply pressure at the dispenser is reading 70 PSI (483 kPa). Adjust the regulator if needed.

### **Error #030: Water Out**

The water pressure is less than 45 PSI (310 kPa).

1	Ensure the water line to the dispenser is on and that the water shutoff at the solution module is turned on.
2	Ensure the gas supply line is connected to the water pump and that the pump is not stalled.
3	Ensure the gas supply pressure at the dispenser is reading 70 PSI (483 kPa). Adjust the regulator if needed.
4	Ensure the water pressure transducer is connected and working properly.

### **Error #041, 042, 043, 044: Tank PSI = 0**

The tank pressure did not rise from 0 PSI (0 kPa) when filling.

1	Run the fill diagnostic sequence to determine the reason for the failure.
---	---



**Error #051, 052, 053, 054: Safety Fill Error**

A barrel filled continuously for more than two minutes.

1	Run the fill diagnostic sequence to determine the reason for the failure.
---	---

**Error #061, 062, 063, 064: Beater Low Error**

A beater motor stalled during operation.

1	Check the brix in the barrel. If low, check the brix at the sample valve and adjust if needed. Drain and refill the barrel.
2	Check the fault code history for multiple sold-out errors within a short period. This can mean that the BIB connector or syrup pump has a suction leak. Fix if necessary.
3	Run the beater circuit diagnostic if a component failure is suspected.

**Error #070: Compressor Ran Too Long**

The compressor ran continuously for more than 90 minutes.

1	Check pressure reset switch (located near compressor inlet port).
2	Is the location an extreme volume venue such as a festival? If so, contact FBD service for instructions on adjusting the timer.

**Error #081, 082, 083, 084: High Barrel Pressure**

The pressure on a barrel exceeded 55 PSI (379 kPa).

1	Dispense a drink to reduce the barrel pressure. The dispenser will refreeze if set to the ON mode.
2	Run the fill diagnostic if a failed component is suspected.
3	Check the "Active Charge" regulator located on the product header to ensure it is set at 30 PSI (207 kPa). All barrels should be fully depressurized before checking the active charge. On non-DCC dispensers, use a tire gauge to check the pressure. On DCC dispensers, use the pressure displayed on the LCD Screen.

**Error #090: Hot Product Detected**

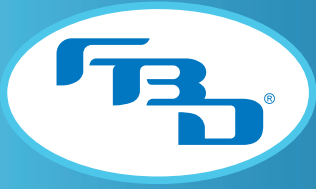
The system shut down because product in a barrel exceeds 90° F (32.2° C) for 200 seconds or 110° F (43.3° C) for 50 seconds depending on dispenser software.

1	Check the return temperature sensor for proper operation.
2	If hot product was detected, call FBD for technical assistance.

**Error #111, 112, 113, 114: Motor Failure**

The beater motor is not operating.

1	Run a beater circuit diagnostic to determine the problem or refer to error #58X in this manual.
2	Check to make sure the beater motor is plugged in.



**Error #121, 122, 123, 124: Beater High Error**

The control board is not reading the proper value from the beater motor.

1	Run a defrost cycle to reset the motor baseline value.
2	Run a beater circuit diagnostic to determine the problem or refer to error #58X in this manual.

**Error #130: Board Failure**

The control board is not functioning properly.

1	Cycle the power to the dispenser to see if it will clear the error.
2	Replace the control board.

**Error #140: Low Regulated CO<sub>2</sub> PSI**

The regulated CO<sub>2</sub> pressure dropped below 50 PSI (345 kPa).

1	Ensure the CO <sub>2</sub> supply is not low.
2	Check the “carbonation” regulator on the header tray and ensure it is set to 60 PSI (414 kPa).

**Error #150: High Regulated CO<sub>2</sub> PSI**

The regulated CO<sub>2</sub> pressure is above 70 PSI (483 kPa).

1	Check the “carbonation” regulator on the header tray and ensure it is set to 60 PSI (414 kPa).
---	--

**Error #160: Low Line Voltage**

The voltage supply is below 200 volts.

1	Install a boost transformer or Automatic Voltage Regulator (AVR). Even if the voltage is slightly above 200V, a boost transformer or AVR may be needed as fluctuations in power during the day, or during dispenser operation may cause it to drop below 200 volts and shut down the dispenser. <b>Note:</b> For optimal performance and to avoid component failures, FBD recommends dispenser be supplied with 230 VAC ± 10%.
---	---

**Error #170: High Line Voltage**

The voltage supply is above 254 volts.

1	Install a buck transformer or Automatic Voltage Regulator (AVR). <b>Note:</b> For optimal performance and to avoid component failures, FBD recommends dispenser be supplied with 230 VAC ± 10%.
---	--

**Error #180: LPSI Transducer**

The low side refrigeration pressure is not reading correctly.

1	Ensure the pressure transducer is plugged in.
2	Replace the transducer if faulty.



**Error #190: HPSI Transducer**

The high side refrigeration pressure is not reading correctly.

1	Ensure the pressure transducer is plugged in.
2	Replace the transducer if faulty.

**Error #200: Return Temperature Sensor**

The refrigeration return (suction) temperature sensor is not reading correctly.

1	Ensure the temperature sensor is plugged in.
2	Replace the sensor if faulty.

**Error #240: Active Charge Cannot Vent**

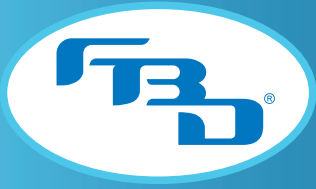
If the DCC module has attempted to vent five times unsuccessfully, the active charge pressure will not decrease to target pressure range.

1	Verify the vent solenoid is electrically opening and closing using the MANUAL ON/OFF menu.
2	Verify the fill and vent solenoid inputs are not swapped.
3	Verify that gas is not bypassing the fill solenoid in the DCC module. Disconnect both solenoid harness connections and verify the active charge pressure on the READOUTS menu is not climbing. If the pressure reaches the incoming gas pressure then the fill solenoid is leaking.
4	Ensure that syrup has not entered the active charge system due to a failed expansion tank. This may cause the orifice in the DCC module to be clogged.

**Error #250: Active Charge Cannot Fill**

The DCC module has attempted to fill five times unsuccessfully, the active charge pressure will not decrease to target pressure range.

1	Verify the fill solenoid is electrically opening/closing using the MANUAL ON/OFF menu.
2	Verify the fill and vent solenoid inputs are not swapped.
3	Verify "Active Charge" input on the harness is plugged into the pressure transducer on the DCC module.
4	Verify no gas is leaking out of the active charge system. Check any new tubing/Oetikers that were installed for leaks. Disconnect both solenoid harness connections and verify the active charge pressure on the READOUTS menu is not slowly decreasing to 0 PSI (0 kPa).
5	Verify that syrup or debris has not entered the incoming gas line. Check screen in fill orifice.
6	Dispenser does not have a DCC. Change the ACTIVE CHARGE setting to DISABLED in the SETTINGS menu.



**Error #270: Air Out**

The compressed air pressure is less than 45 PSI (310 kPa).

1	Verify there is a supply of compressed air.
2	Ensure the compressed air shutoff valve at the back of the dispenser is not turned off.
3	Ensure the gas pressure transducer is connected and working properly.
4	Ensure the compressed air supply pressure at the dispenser is reading 70 PSI (483 kPa). Adjust the regulator if needed.

**Error #280: N<sub>2</sub> Out**

The N<sub>2</sub> pressure is less than 45 PSI (310 kPa).

1	Replace or refill the N <sub>2</sub> tank.
2	Ensure the N <sub>2</sub> shutoff valve at the back of the dispenser is not turned off.
3	Ensure the N <sub>2</sub> pressure transducer is connected and working properly.
4	Ensure the N <sub>2</sub> supply pressure at the dispenser is reading 70 PSI (483 kPa). Adjust the regulator if needed.

**Error #290: Gas #1 - CO<sub>2</sub> Out**

The CO<sub>2</sub> pressure is less than 45 PSI (310 kPa) for barrel 1.

1	Replace or refill the CO <sub>2</sub> tank.
2	Ensure the CO <sub>2</sub> shutoff valve at the back of the dispenser is not turned off.
3	Ensure the CO <sub>2</sub> pressure transducer is connected and working properly.
4	Ensure the CO <sub>2</sub> supply pressure at the dispenser is reading 70 PSI (483 kPa). Adjust the regulator if needed.

**Error #340: Flavor Add-On Board Missing**

The dispenser cannot detect the flavor add-on board. The board is missing or damaged.

1	Ensure the software matches the dispenser's hardware configuration.
2	Ensure the flavor add-on board is installed and seated properly on the control board.
3	Replace the flavor add-on board if faulty.



**Error #351, 352: Flavor Out 1**

**Error #361, 362: Flavor Out 2**

**Error #371, 372: Flavor Out 3**

**Error #381, 382: Flavor Out 4**

The pressure for flavor syrup is less than 45 PSI (310 kPa), where the “Out” number represent the flavor number.

1	Replace the empty BIB.
2	Ensure the gas line is connected to the BIB pump.
3	Ensure the BIB pump is operating correctly.
4	Ensure the gas tank is not empty.
5	Ensure any syrup shutoff valves at the back of the dispenser are not turned off.
6	Ensure the syrup supply pressure at the dispenser is reading 70 PSI (483 kPa). Adjust the regulator if needed.
7	Ensure the syrup pressure transducer for that flavor is connected and working properly.

**Error #390: No ADA Keypad Detected**

The ADA keypad is missing, disconnected or damaged.

1	Ensure ADA keypad has no visible damage.
2	Ensure the keypad connector is plugged in correctly. Make sure that the arrows on each connector align.
3	Replace the keypad if faulty.

**Error #400: ADA Keypad Shorted**

The ADA keypad button(s) are damaged or have been pressed longer than 12 seconds.

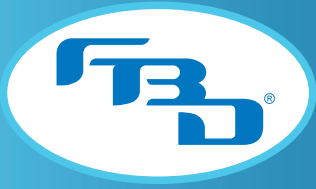
1	Ensure the ADA keypad is connected correctly. Make sure that the arrows on each connector align.
2	Replace the keypad if faulty.

**Error #410: Gas #1 - N<sub>2</sub> Out**

**Error #420: Gas #2 - N<sub>2</sub> Out**

The nitrogen (N<sub>2</sub>) pressure is less than 45 PSI (310 kPa) for barrel 1 (Gas #1) or barrel 2 (Gas #2).

1	Replace or refill the N <sub>2</sub> tank.
2	Ensure the N <sub>2</sub> shutoff valve at the back of the dispenser is not turned off.
3	Ensure the N <sub>2</sub> pressure transducer is connected and working properly.
4	Ensure the N <sub>2</sub> supply pressure at the dispenser is reading 70 PSI (483 kPa). Adjust the regulator if needed.



**Error #430: Gas #2 - CO<sub>2</sub> Out**

The CO<sub>2</sub> pressure is less than 45 PSI (310 kPa) for barrel 2.

1	Replace or refill the CO <sub>2</sub> tank.
2	Ensure the CO <sub>2</sub> shutoff valve at the back of the dispenser is not turned off.
3	Ensure the CO <sub>2</sub> pressure transducer is connected and working properly.
4	Ensure the CO <sub>2</sub> supply pressure at the dispenser is reading 70 PSI (483 kPa). Adjust the regulator if needed.

**Error #440: Gas #1 - Low Regulated CO<sub>2</sub> PSI**

The regulated CO<sub>2</sub> pressure dropped below 50 PSI (345 kPa) for barrel 1.

1	Ensure the CO <sub>2</sub> supply is not low.
2	Check the "Gas 1" regulator on the header tray and ensure it is set to 60 PSI (414 kPa).

**Error #450: Gas #1 - High Regulated CO<sub>2</sub> PSI**

The regulated CO<sub>2</sub> pressure is above 70 PSI (483 kPa) for barrel 1.

1	Check the "Gas 1" regulator on the header tray and ensure it is set to 60 PSI (414 kPa).
---	--

**Error #460: Gas #1 - Low Regulated N<sub>2</sub> PSI**

The regulated N<sub>2</sub> pressure dropped below 50 PSI (345 kPa) for barrel 1.

1	Ensure the N <sub>2</sub> supply is not low.
2	Check the "Gas 1" regulator on the header tray and ensure it is set to 60 PSI (414 kPa).

**Error #470: Gas #1 - High Regulated N<sub>2</sub> PSI**

The regulated N<sub>2</sub> pressure is above 70 PSI (483 kPa) for barrel 1.

1	Check the "Gas 1" regulator on the header tray and ensure it is set to 60 PSI (414 kPa).
---	--

**Error #480: Gas #2 - Low Regulated CO<sub>2</sub> PSI**

The regulated CO<sub>2</sub> pressure dropped below 50 PSI (345 kPa) for barrel 2.

1	Ensure the CO <sub>2</sub> supply is not low.
2	Check the "Gas 2" regulator on the header tray and ensure it is set to 60 PSI (414 kPa).

**Error #490: Gas #2 - High Regulated CO<sub>2</sub> PSI**

The regulated CO<sub>2</sub> pressure is above 70 PSI (483 kPa) for barrel 2.

1	Check the "Gas 2" regulator on the header tray and ensure it is set to 60 PSI (414 kPa).
---	--

**Error #1000: Gas #2 - Low Regulated N<sub>2</sub> PSI**

The regulated N<sub>2</sub> pressure dropped below 50 PSI (345 kPa) for barrel 2.

1	Ensure the N <sub>2</sub> supply is not low.
2	Check the "Gas 2" regulator on the header tray and ensure it is set to 60 PSI (414 kPa).

**Error #1010: Gas #2 - High Regulated N<sub>2</sub> PSI**

The regulated N<sub>2</sub> pressure is above 70 PSI (483 kPa) for barrel 2.

1	Check the "Gas 2" regulator on the header tray and ensure it is set to 60 PSI (414 kPa).
---	--



## 10.3 Diagnostic Fault Codes

The following codes are faults that can be displayed after running a diagnostic sequence.

### Error #581, 582, 583, 584: Beater Motor Not Turning On

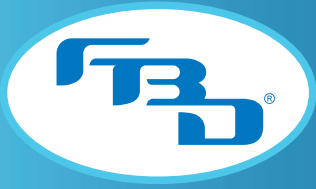
1	Remove the control board and check for blown motor fuses (Motor 1: F3 & F4, Motor 2: F5 & F6, Motor 3: F7 & F8, Motor 4: F9 & F10). A motor or capacitor malfunction may be caused by a blown fuse.
2	If fuses are OK, reinstall control board.
3	Disconnect wiring harness from suspect beater motor.
4	Manually turn on beater motor using the SERVICE MENU and ensure there is line voltage on pins 1 & 3 of supply harness (outside pins).
5	If correct voltage is present, substitute a "known to be good" capacitor and try to operate motor again. If no voltage is present (when activated through the menu), then replace the beater motor power harness.
6	If motor fails to start with working capacitor, then replace both motor and capacitor.

### Error #591, 592, 593, 594: Gas Solenoid Not Opening

1	Disconnect the electrical harness from the gas solenoid for the barrel in question.
2	Manually activate the solenoid and check to make sure there is 12 VDC at the connection (the voltage will read ~2 VDC when not powered). If no voltage, then replace the control board.
3	If correct voltage is present, replace the solenoid. Be sure to turn off the gas supply before disconnecting the gas line from the solenoid.
4	If solenoid is functioning properly, then a leak may be present in the product delivery system. Check the relief valve, dispensing valve, rear seal and tubing in the product tray for leaks.
5	If no leaks are found, then the tank pressure transducer may be defective.

### Error #601, 602, 603, 604: Solution Solenoid Not Opening

1	Disconnect the electrical harness from the suspect solution solenoid.
2	Manually activate the solenoid and check for 24 VAC at the connection (the voltage will read ~19 VAC when not powered). If no voltage, then replace the control board.
3	If correct voltage is present, remove the solution module and replace the solenoid.



**Error #611, 612, 613, 614: Gas or Solution Leak**

The barrel pressure is rising during a fill circuit diagnostic test.

1	Determine if the barrel is filling with gas or liquid. If the barrel liquid level is low enough, use a flashlight to look at the back of the barrel and see if liquid is entering the barrel. Replace a leaking solenoid.
2	Ensure the solenoids are not manually turned on by going to the MANUAL ON/OFF menu. Check to see if either solenoid is receiving power by removing the leads and testing with a voltmeter. If 12 VDC is measured on the gas solenoid, or 24 VAC is measured on the solution solenoid, then replace the control board.

**Error #621, 622, 623, 624: Barrel Leak**

The barrel pressure is dropping during a fill circuit diagnostic test.

1	Look for any obvious leaks by searching for liquid along the product line from the solution module to the back of the barrel.
2	Inspect the rear seal to determine if the leak is originating from it.
3	Inspect the relief valve in the faceplate to determine if the leak is originating from it. Press and turn the relief valve to firmly seat.
4	Inspect the dispensing nozzle to determine if the leak is originating from it.



## 11. DIAGRAMS AND SCHEMATICS

### 11.1 Flow Diagrams (Multi-Flavor Dispensers)

Figure 11.4 shows the plumbing diagram for the 771 multi-flavor dispenser. Figure 11.5 shows the plumbing diagram for the 772 multi-flavor dispenser.

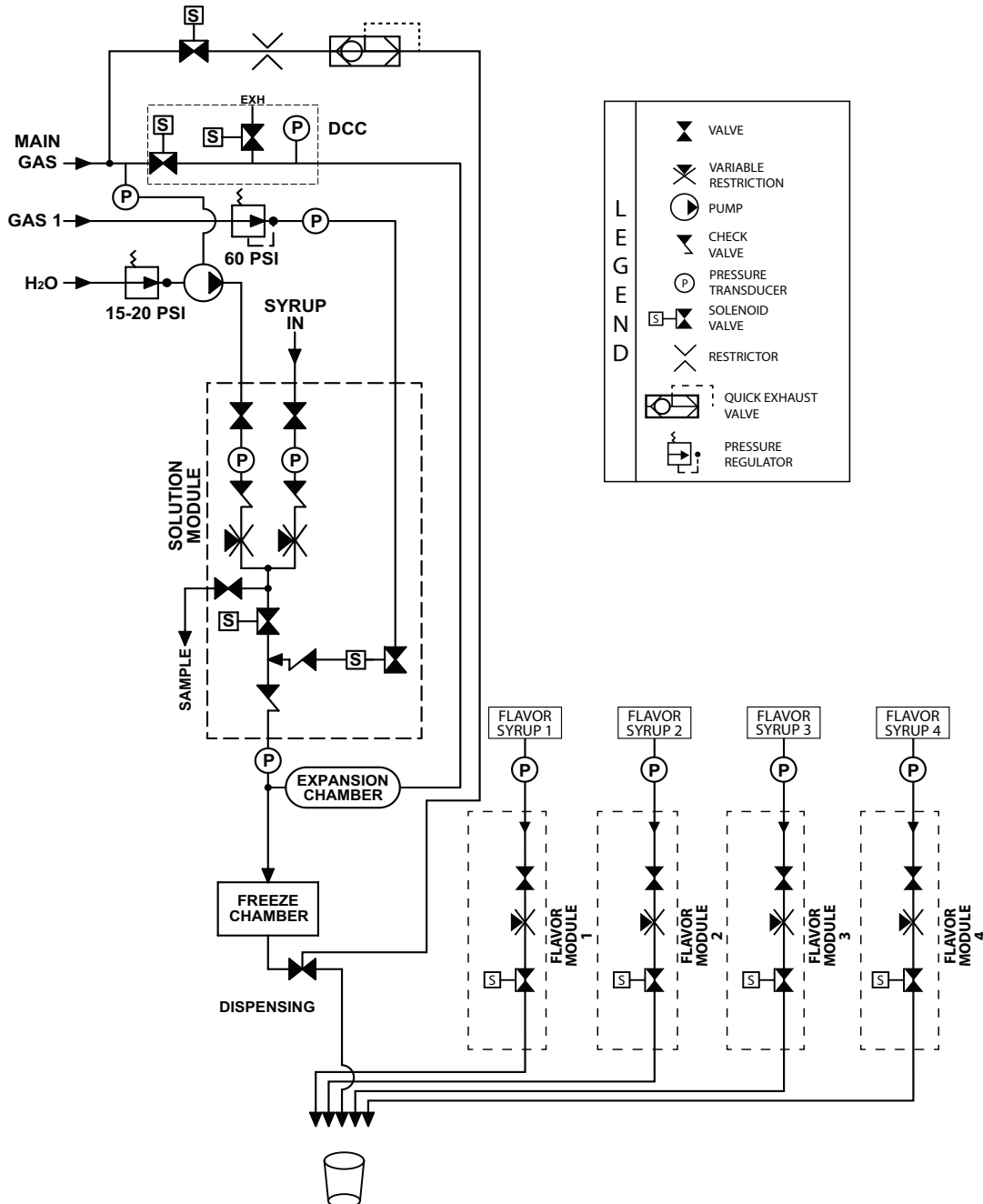
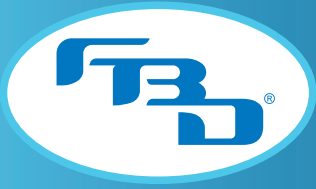


Figure 11.1 Flow Diagram for 771 Multi-Flavor Dispenser



# 77X INSTALLATION & OPERATION MANUAL 771/772/773/774 MODELS

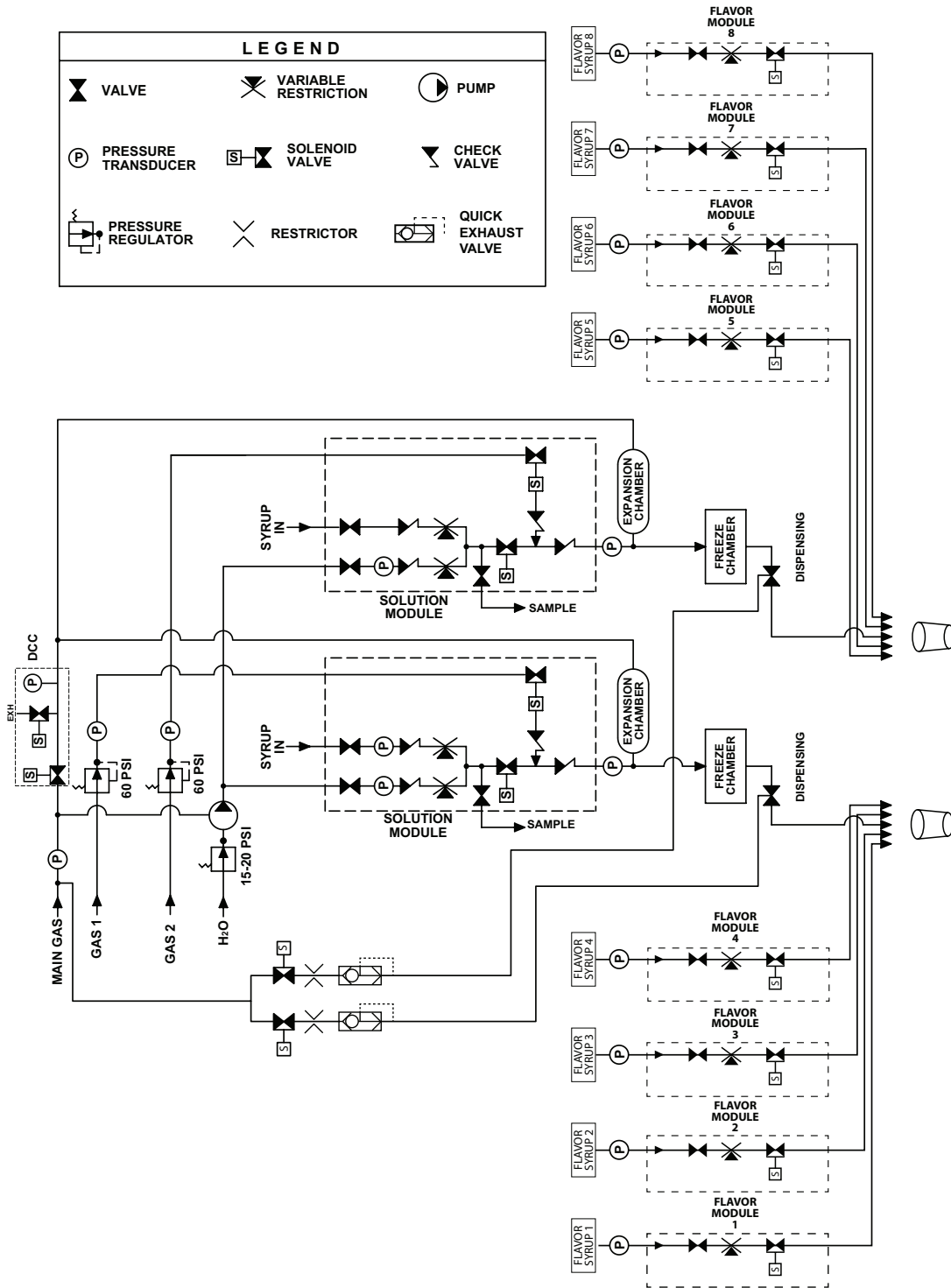


Figure 11.2 Flow Diagram for 772 Multi-Flavor Dispenser



## 11.2 Flow Diagrams (Standard Dispensers)

Figure 11.3 shows the plumbing diagram for the standard 774 dispensers and is representative of the standard 772 and 773 dispensers with the exception of the number of barrels.

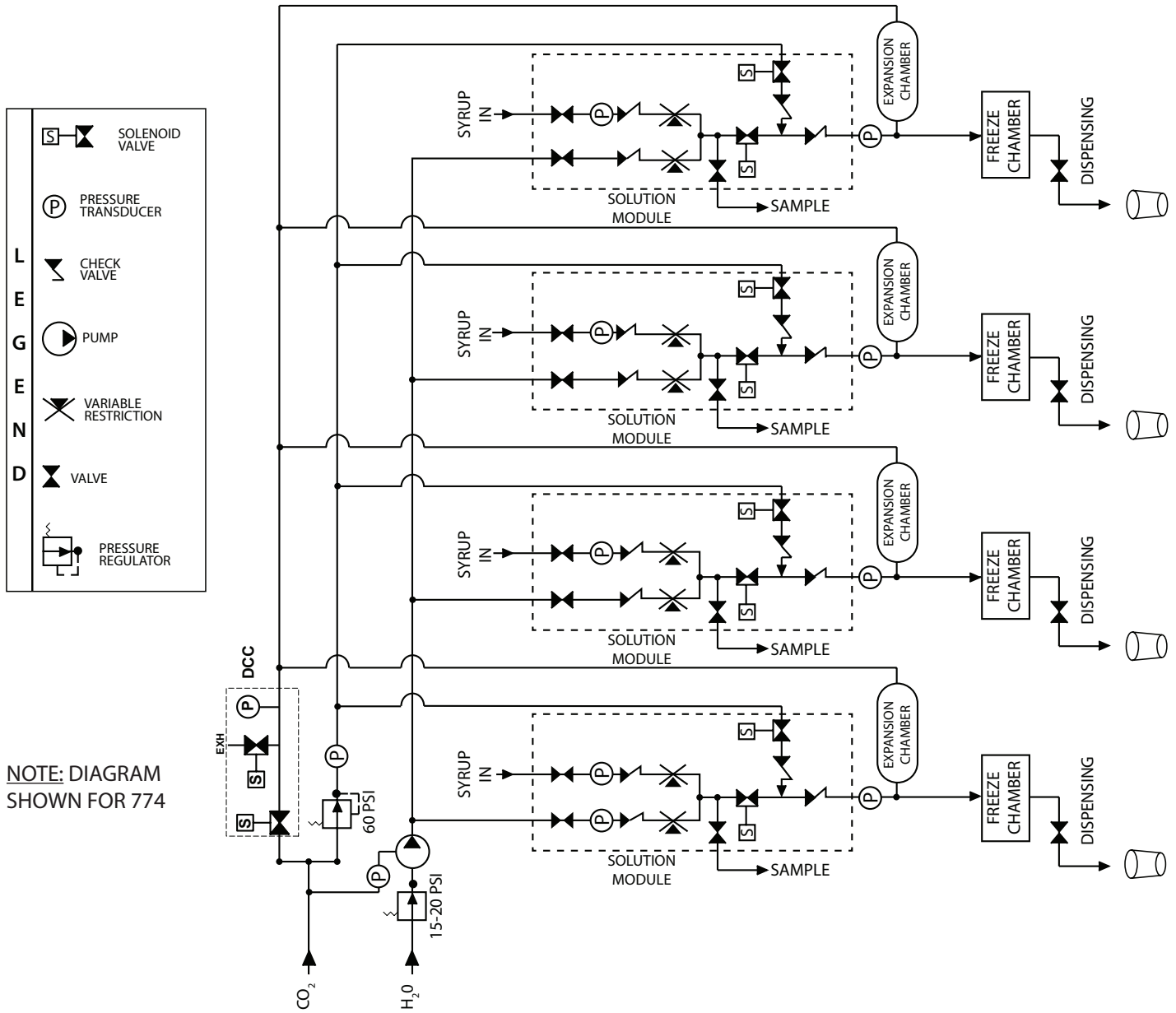
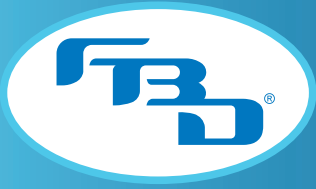
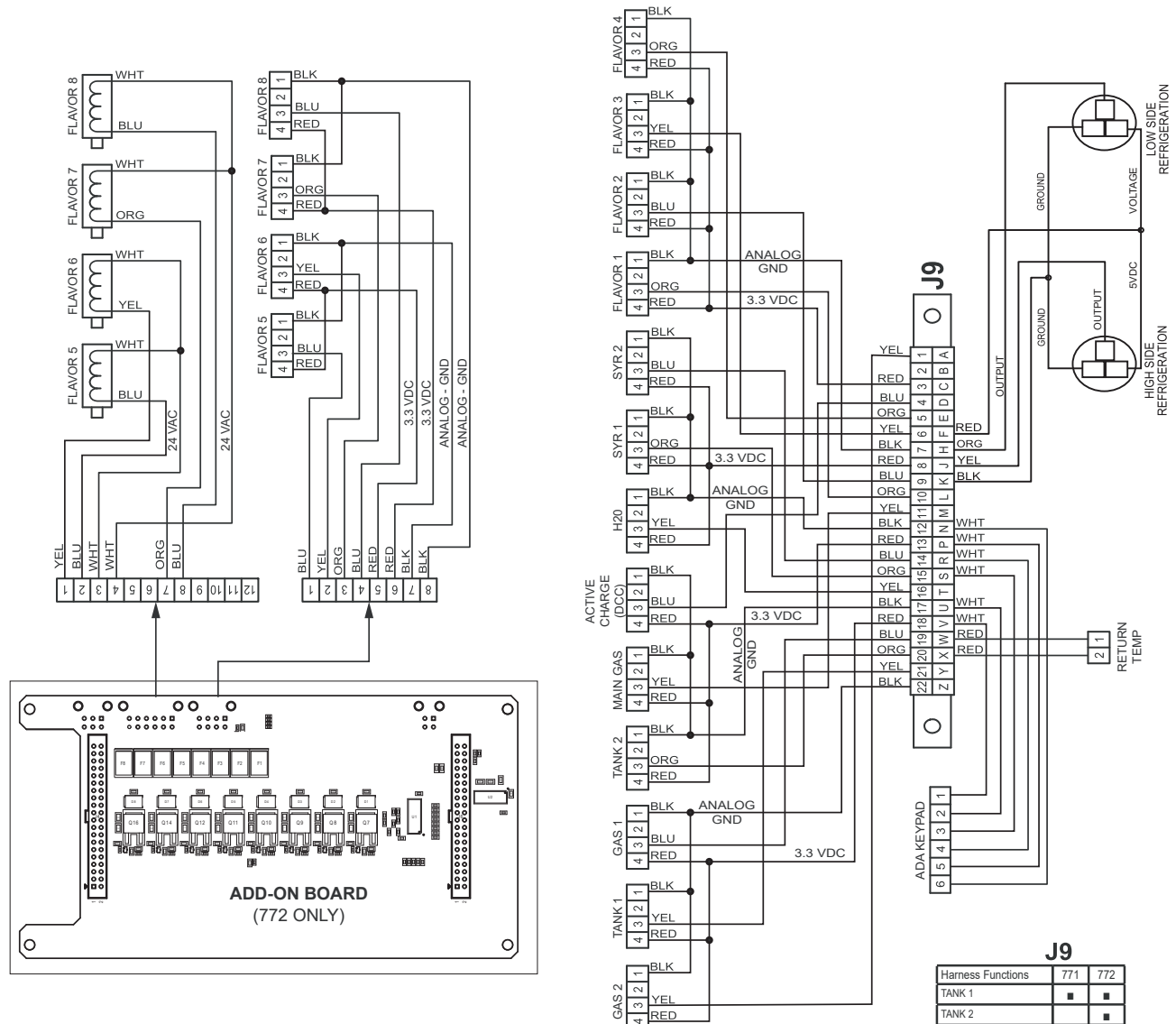


Figure 11.3 Flow Diagram for 772, 773 and 774 Standard Dispensers



### 11.3 Electrical Wiring Diagrams (Multi-Flavor Dispensers)

Figures 11.4 through 11.6 show the electrical wiring diagrams for 771 & 772 multi-flavor dispensers. The diagrams show the 772 multi-flavor model and is representative of the 771 and 772 multi-flavor dispensers with the exception of the number of barrels.

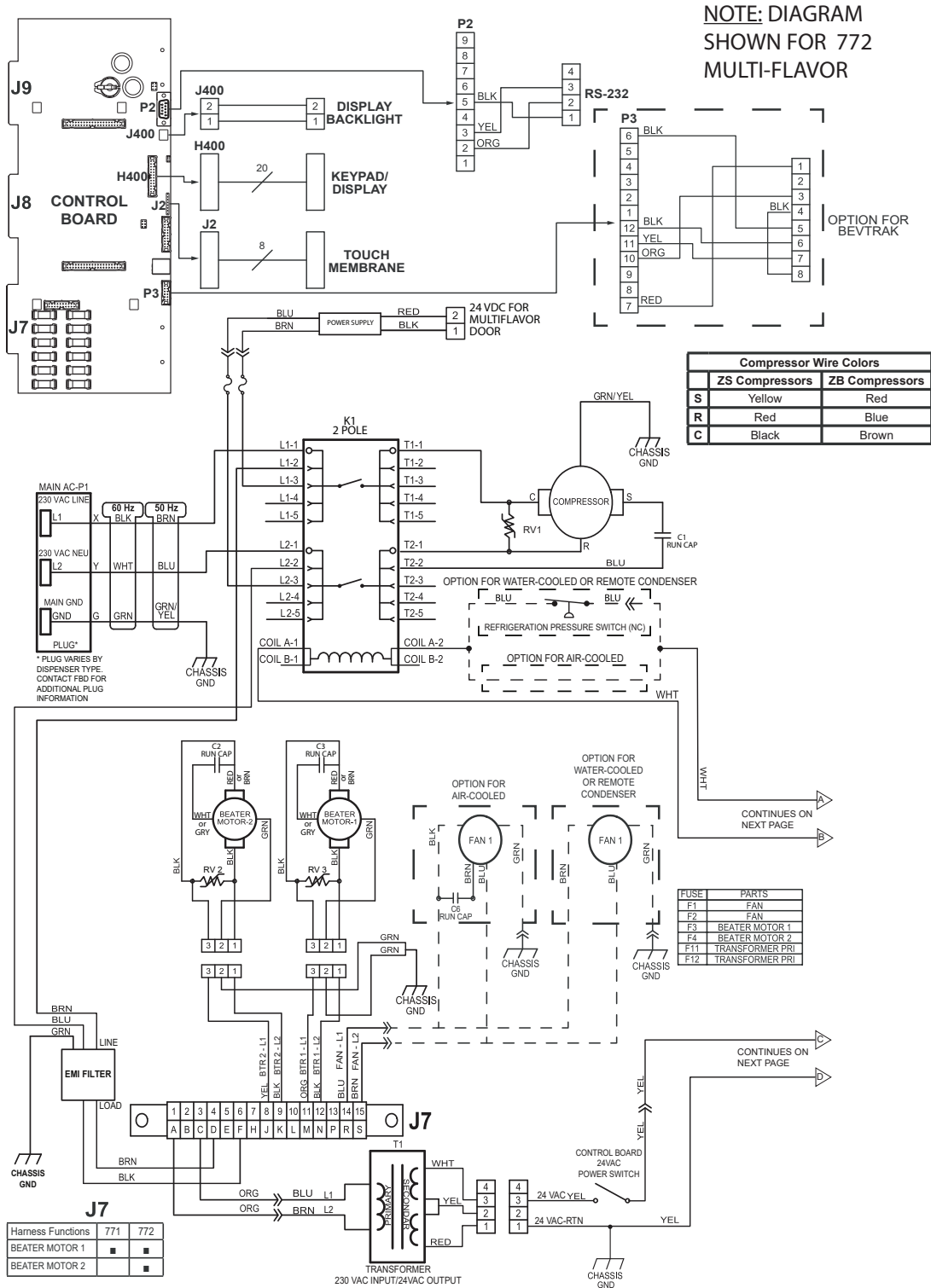


NOTE: DIAGRAM  
SHOWN FOR 772  
MULTI-FLAVOR

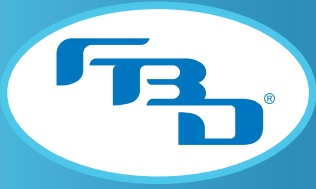
Figure 11.4 Electrical Diagram for 771 and  
772 Multi-Flavor Dispensers (1 OF 3)

# 77X INSTALLATION & OPERATION MANUAL

## 771/772/773/774 MODELS



**Figure 11.5 Electrical Diagram for 771 and 772 Multi-Flavor Dispensers (2 OF 3)**



# 77X INSTALLATION & OPERATION MANUAL 771/772/773/774 MODELS

## J8

Harness Functions	771	772
SOL1	■	■
SOL2		■
CO2 1	■	■
CO2 2		■
REF 1	■	■
REF 2		■
DEF 1	■	■
DEF 2		■
FLAVOR 1	■	■
FLAVOR 2	■	■
FLAVOR 3	■	■
FLAVOR 4	■	■
DISP 1	■	■
DISP 2	■	■
VENT	■	■
FILL	■	■

NOTE: DIAGRAM  
SHOWN FOR 772  
MULTI-FLAVOR

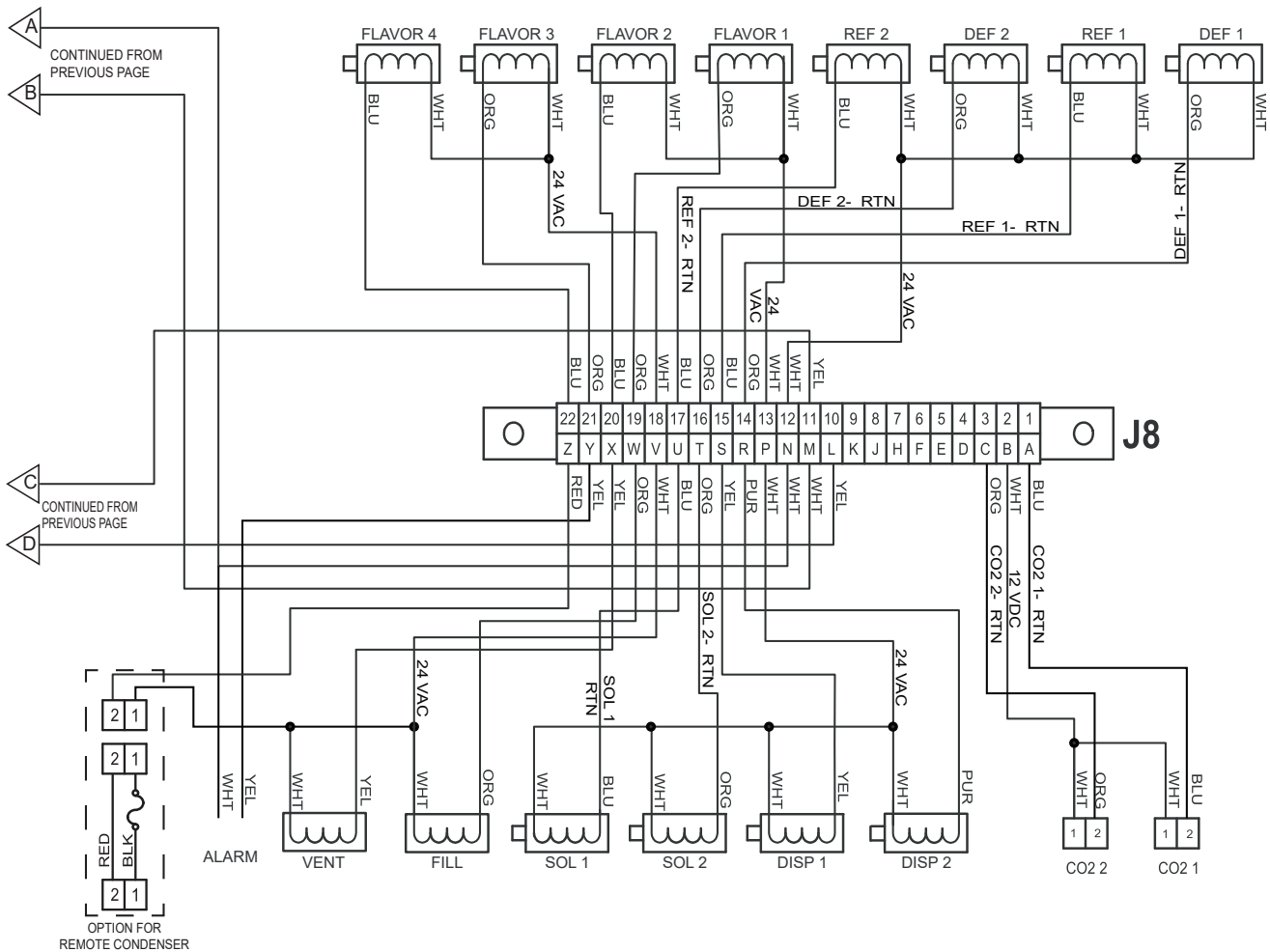


Figure 11.6 Electrical Diagram for 771 and 772 Multi-Flavor Dispensers (3 OF 3)



### 11.4 Electrical Wiring Diagrams (Standard Dispensers)

Figures 11.7 through 11.9 show the electrical wiring diagrams for the standard 774 dispenser and are representative of the standard 772 and 773 dispensers with the exception of the number of barrels.

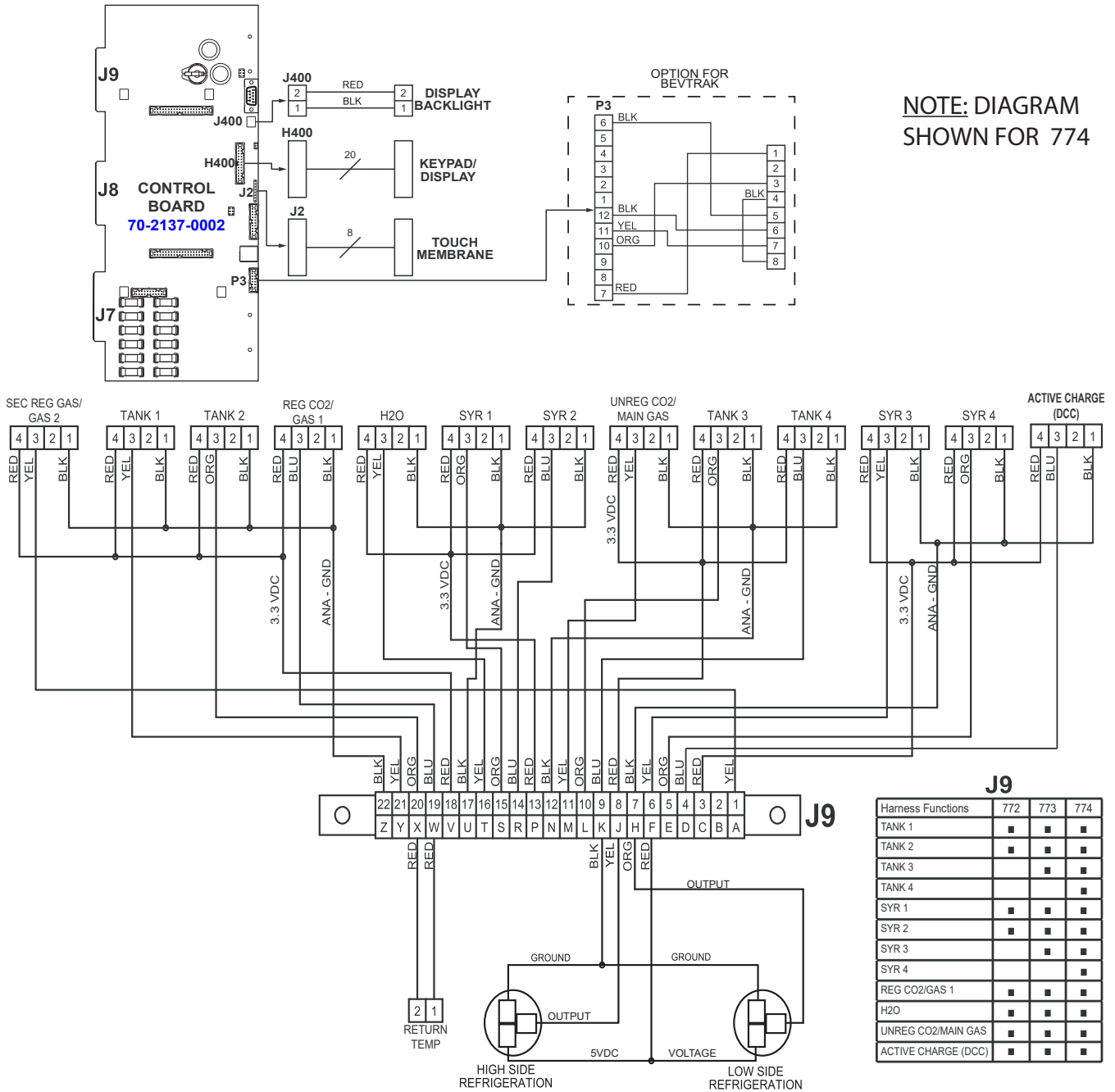
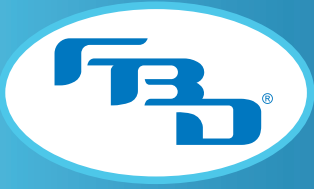


Figure 11.7 Electrical Diagram for 772, 773, and 774 Dispensers



# 77X INSTALLATION & OPERATION MANUAL

## 771/772/773/774 MODELS

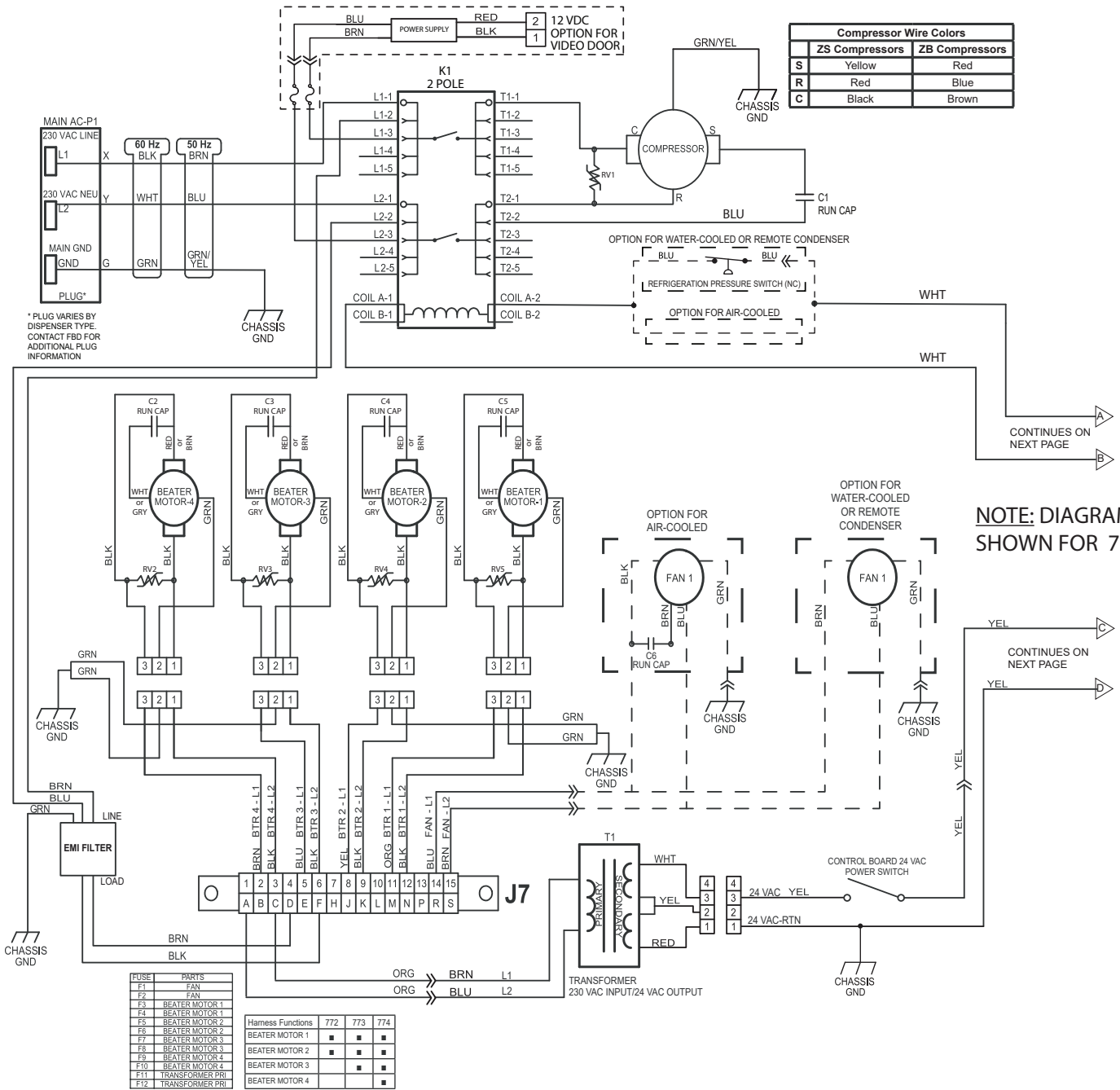


Figure 11.8 Electrical Diagram for 772, 773, and 774 Dispensers

# 77X INSTALLATION & OPERATION MANUAL

## 771/772/773/774 MODELS

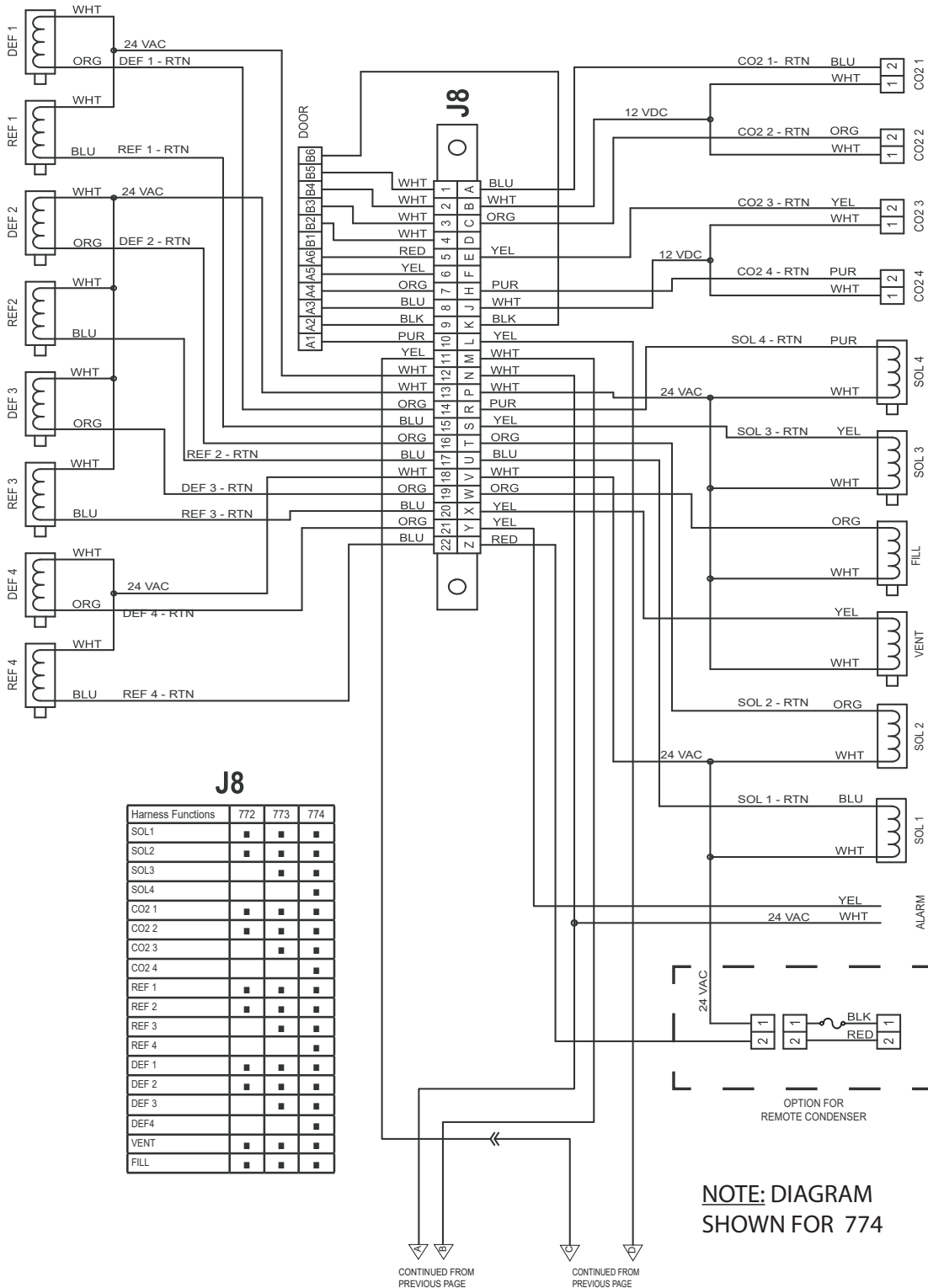
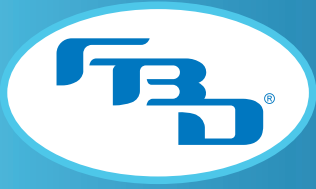


Figure 11.9 Electrical Diagram for 772, 773, and 774 Dispensers  
3 OF 3



## 11.5 Refrigeration Schematic Diagrams (Air-Cooled Dispensers)

Figure 11.10 shows the refrigeration schematic for the 773 air-cooled dispenser and is representative of the 771 and 772, with the exception of the number of barrels. Figure 11.11 illustrates the schematic for 774 air-cooled dispensers.

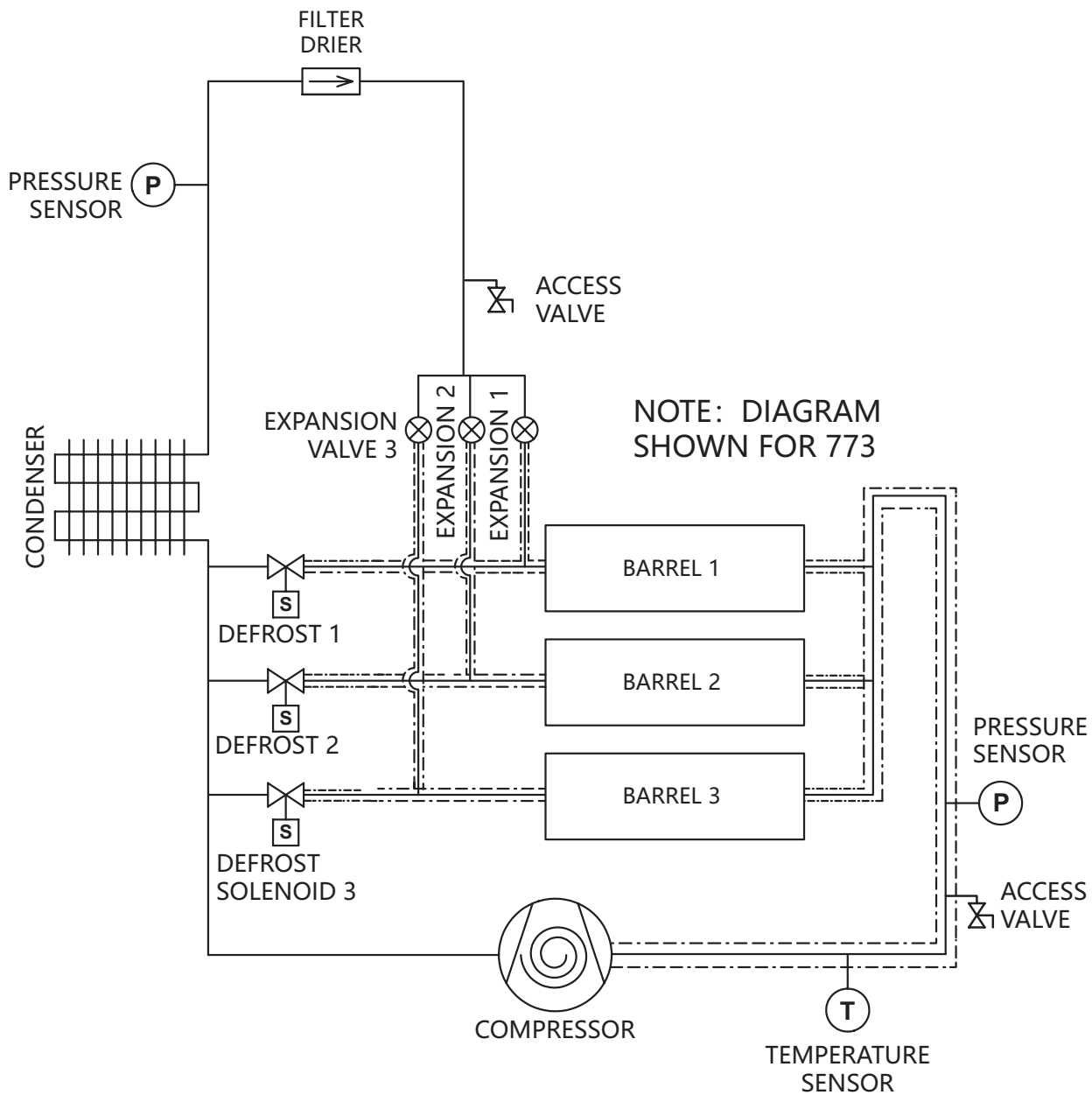


Figure 11.10 Refrigeration Schematic for 771, 772, and 773 Air-Cooled Dispensers

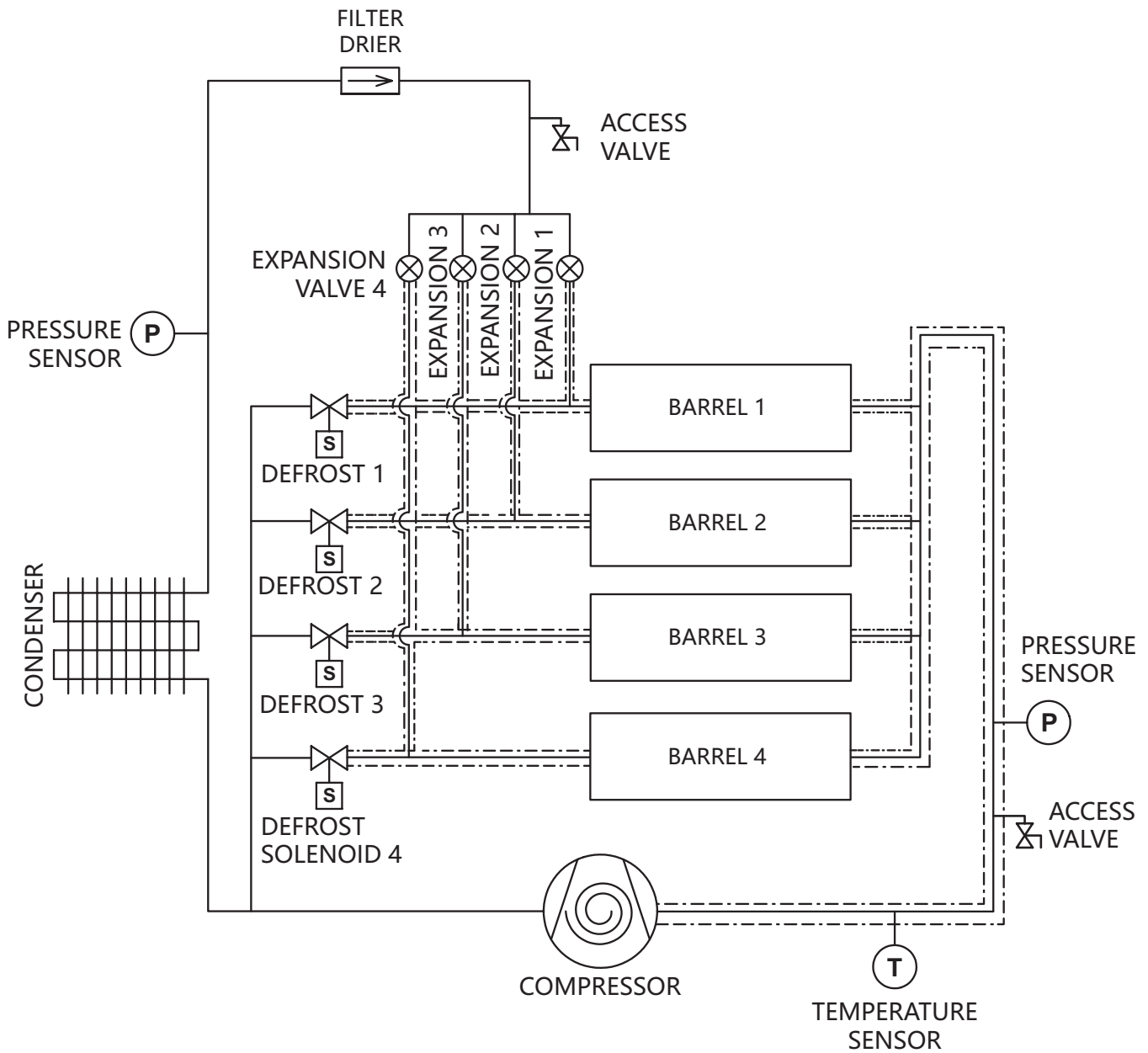
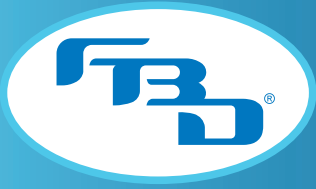


Figure 11.11 Refrigeration Schematic for 774 Air-Cooled Dispensers



## 11.6 Refrigeration Schematic Diagrams (Remote Condensing Dispensers)

Figure 11.12 shows the refrigeration schematic for the 774 remote condensing dispenser and is representative of the 771, 772, and 773 dispensers, with the exception of the number of barrels.

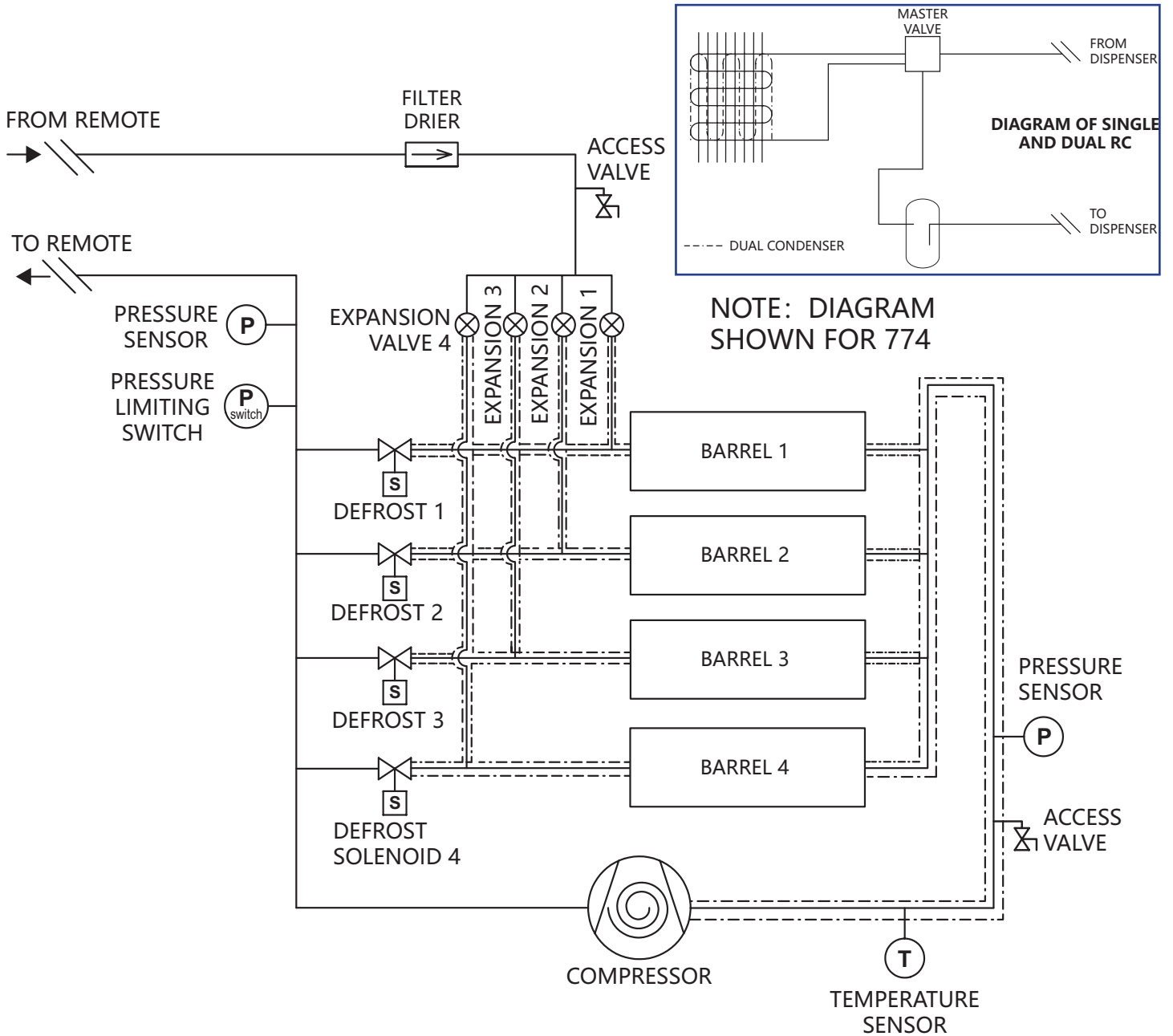


Figure 11.12 Refrigeration Schematic for 771, 772, 773, and 774  
Remote Condensing Dispensers



## 11.7 Refrigeration Schematic Diagrams (Water-Cooled Dispensers)

Figure 11.13 shows the refrigeration schematic for the standard 773 water-cooled dispenser and is representative of the 771 and 772 dispensers, with the exception of the number of barrels. Figure 11.14 illustrates the schematic for 774 water-cooled dispensers.

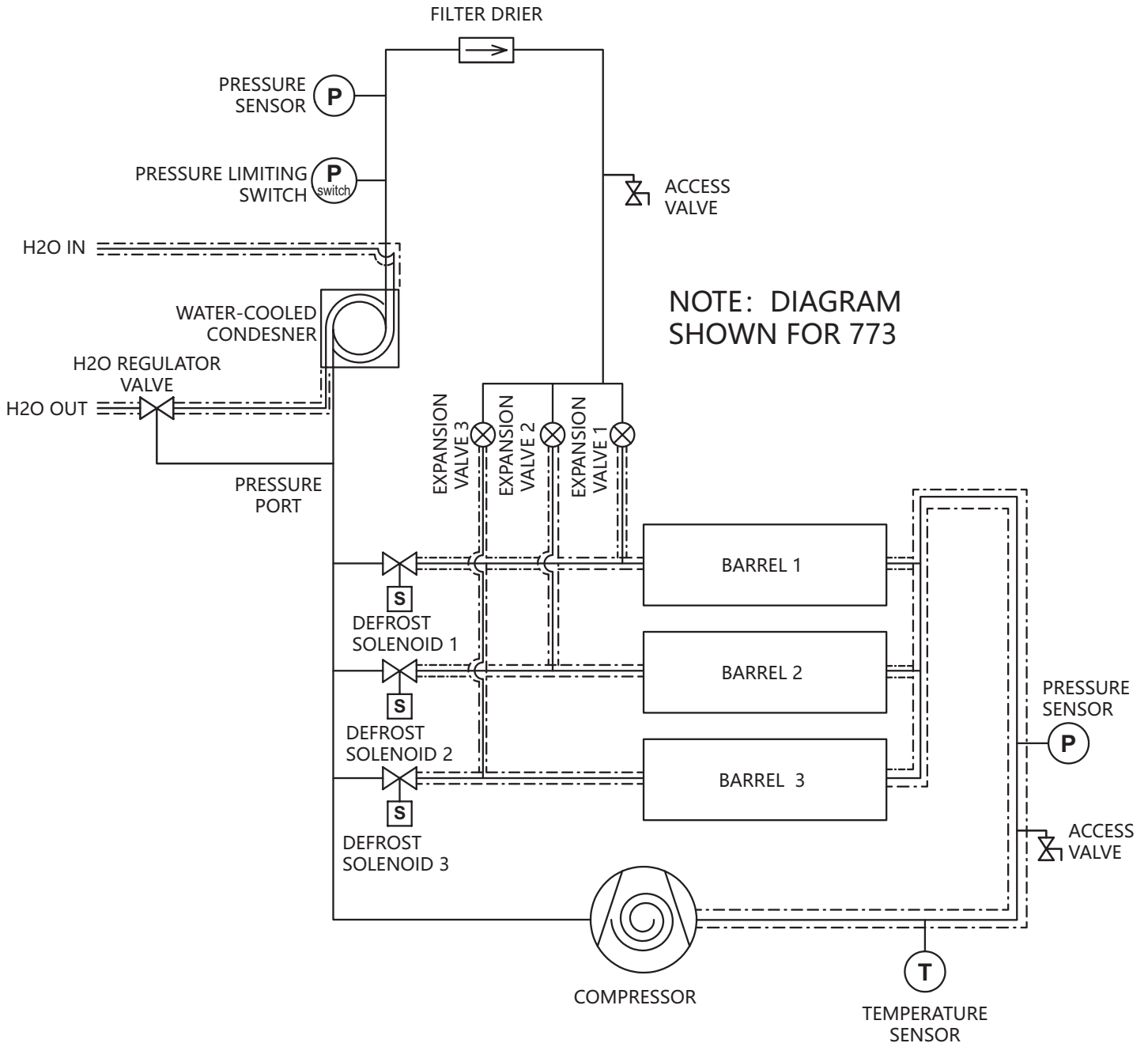


Figure 11.13 Refrigeration Schematic for 771, 772 and 773 Water-Cooled Dispenser

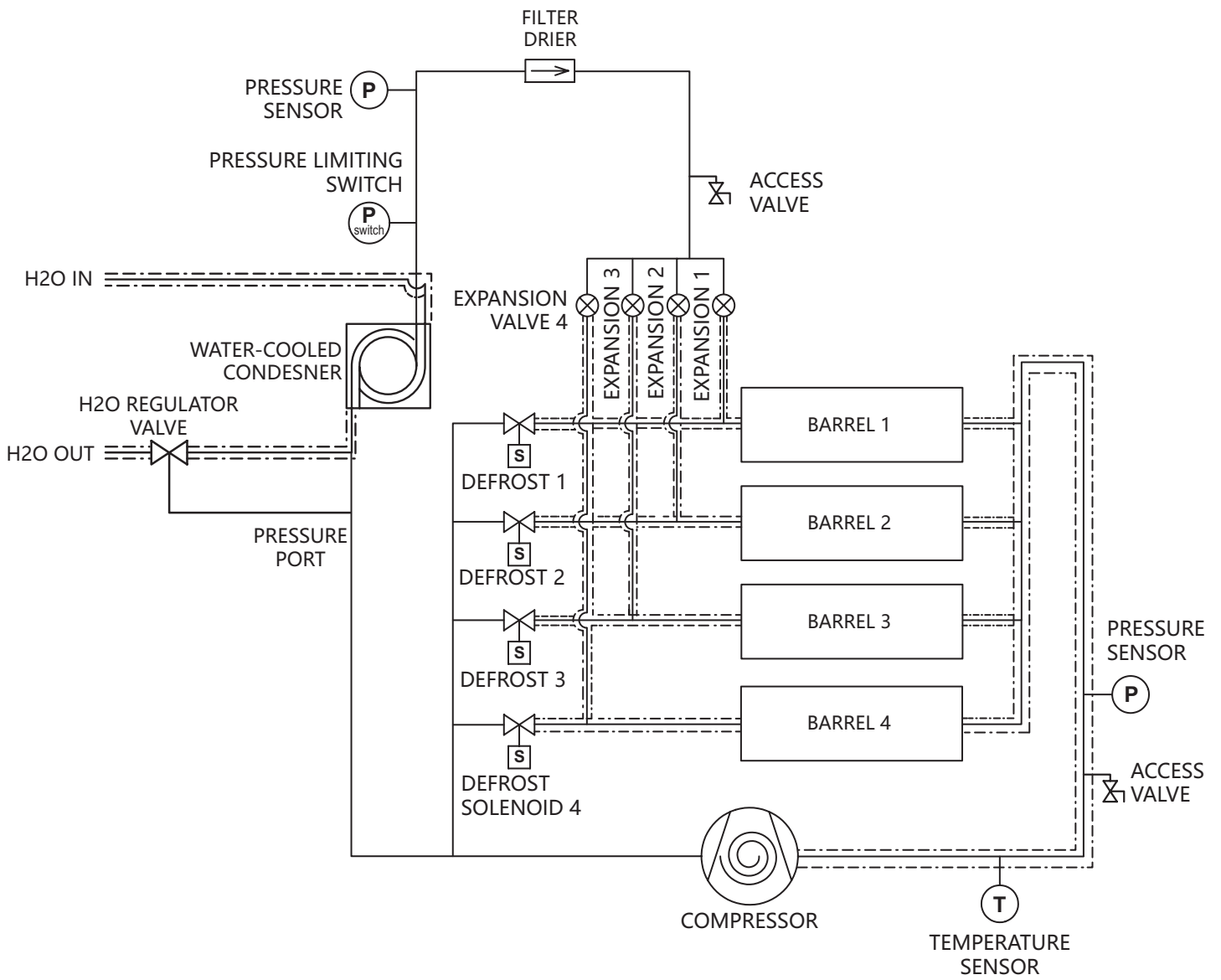
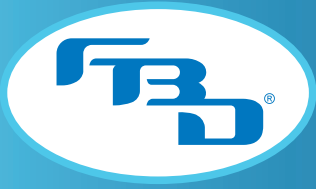


Figure 11.14 Refrigeration Schematic for 774 Water-Cooled Dispenser



# NOTES



The disposal of this product must comply with local regulations. Dispenser is not to be disposed of with household waste. Contact the retailer where this dispenser was purchased or recycle by locating an authorized recycler.