

GRS-1200 Commercial Coffee Grinder

FETCO Commercial Beverage Equipment

EXACTOR PLUS GRINDING SYSTEM®



GRS-1201 Commercial Coffee Grinder



GRS-1202 Commercial Coffee Grinder

SKU	Product Description	Features
G1201US-1A000-00001	One permanent hopper – 3 portion sizes	-FETCO slicing type grinding burrs
G1202US-1A000-00001	Two removable hoppers – 3 portion sizes per side	-Self-adjusting brew basket holder
G1201IN -1B000-00005	Export only: One permanent hopper – 3 portion sizes	-Fully automatic, with digital timer control
G1202IN-1B000-00005	Export Two removable hoppers – 3 portion sizes per side	-Front accessible & Service Friendly
G1201NM-1A000-00001*	One permanent hopper – 3 portion sizes	-Motor overload protection
G1202NM-1A000-00001*	Two removable hoppers – 3 portion sizes per side	-Export versions: 200-240Vac; 50Hz motor

*NM denotes Spanish language labeling and user guide

Contact Information
FETCO®
Food Equipment Technologies Company
600 Rose Road
Lake Zurich • IL • 60047-1560 • USA
© 2018-2024 Food Equipment Technologies Company



Internet: www.fetco.com
Phone: (800) 338-2699 (US & Canada)
(847) 719-3000
Fax: (847) 719-3001
Email: sales@fetco.com
techsupport@fetco.com



Commercial Digital Coffee Grinder

P235 Rev.:000 May 2024

Table of Contents

Specifications	2	D Service Outputs	6
Dimensions & Utility Connections	2	F Service Menu	6
Starting the Grind	3	H Save & Exit	7
Enter Programming	3	Grinder service and maintenance	8
Layout for Programing Menu	4	Parts Diagrams	9
Factory default settings for grinder outputs	5	GRS-1200 Motor Assembly	13
A Grinder Program	5	GRS-1202 Hopper Assembly	14
B General Settings	6	Wiring Diagram	15
C Service Inputs	6		



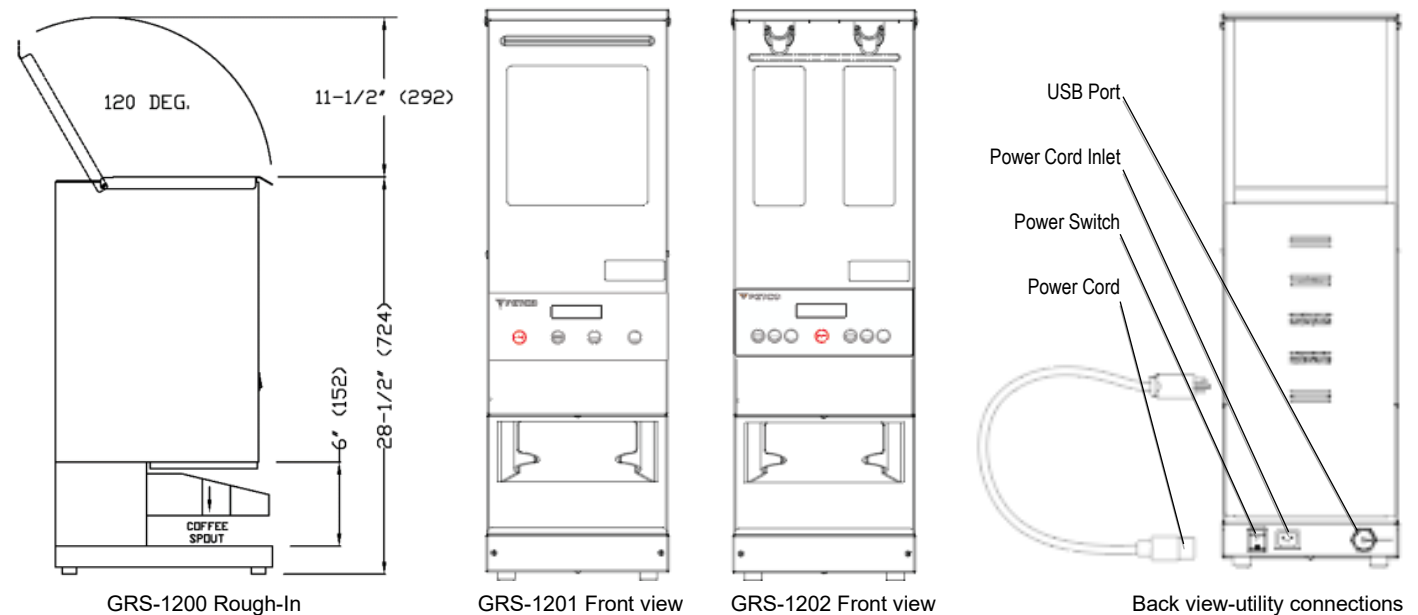

Specifications		Electrical	
Hopper Capacity: GRS-1201: 15 lbs. / 6.8 kg. GRS-1202: 5 lbs. / 2.3 kg. each Timer Range: 5-60 sec . Grind Rate*: 16oz. / 450g per minute Grind Setting Default: Medium Brew Basket Size: 7" to 9" diameter		North America: 120 VAC, 60 Hz single phase 475 Watts Motor: 5.7 amps, 370 Watts, 0.67 HP Grinder is IPX-1 Motor is IP 44 NEMA 5-15P plug/cord Export: 230 VAC, 50 Hz single phase 250 Watts Motor: 3.8 amps, 370 Watts, 0.74 HP IP 44 (motor only) Grinder is IPX-1 Motor is IP 44 Plug/cord configuration set per country electrical-see below	
Sound Rating		Normal 72-75db Momentary pulse for GRS-1202 hopper actuator: 85db	
* Grind rate is determined at medium grind with medium size, average to dark roast beans			

Dimensions & Utility Connections



Model	Minimum height for top opening	Height	Width	Depth	Weight	Shipping Weight	Shipping Dimensions
GRS-1201	40 1/8 (+) in. 1019(+) mm	28 3/4 in. 729mm	9 1/8in. 233mm	16 3/8in. 416 mm	51lb 23kg	67lb 31kg	31"HX12WX19D 788mmHX305mmWx483mmD
GRS-1202	40 1/8 (+) in. 1019(+) mm	28 3/4 in. 729mm	9 1/8in. 233mm	16 3/8in. 416 mm	52lb 24kg	67lb 31kg	31"HX12WX19D 788mmHX305mmWx483mmD

Electrical plug/cord configuration

North America Plug Configuration	 NEMA 5-15P; 120 V Plug Configuration	International Only Plug Configurations	 Export Only 250V 16 A "Schuko" CEE 7/7 PLUG	 Export Only 250V 13 A BS 1363A UK	 Australian AS3112 (YP-35) Plug Configuration	 S AFRICA 250 V; 15/16 A BS 546 [UK2-15P] TYPE M Plug
----------------------------------	---	--	--	---	---	---

Starting the Grind

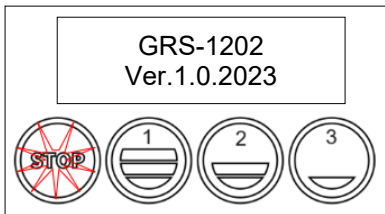
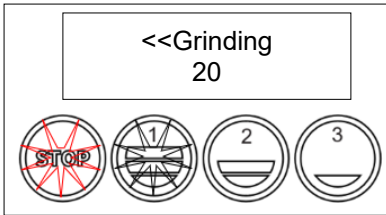
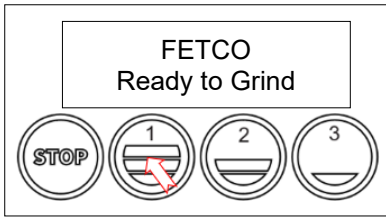

GR-1202 shown on display

1. Place whole coffee beans in hopper
2. Prepare a brew basket with the correct size filter.
3. Slide the prepared brew basket completely into the holder
- 4.. Turn the power switch "ON"
- 5...Select a batch & press the corresponding BATCH button in to start
6. STOP button will illuminate, Batch Selector button will illuminate
7. -Countdown time will display. Default time setting is 20;13;7 seconds (6,4,2.5 oz)
-Selected BATCH button will slowly pulsate to indicate grinding is in progress.
-All other BATCH buttons will remain unlit during the grind cycle.

8. When the grind cycle is finished, STOP button will extinguish ..
9. Remove the filled brew basket and proceed to brew

GRS-1202 only-Solenoid Delay

1. Closes hopper guillotine and leaves motor running to empty grind chamber (If activated)
2. Factory default is ACTIVATED with 20 SECOND delay.
The GRS-1202 solenoid delay feature prevents mixing the coffee types in the two hoppers (such as regular in one hopper and decaffeinated in the other)

Enter Programming

There are 6 menu groups-A-F plus EXIT (G). ("E" level has not been added as of January 2024)
See the following pages for the batch parameter definitions and all settings for the grinder

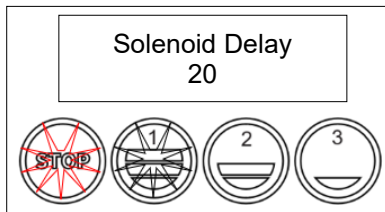

TO ENTER PROGRAMMING

- 1-Turn grinder "OFF" from power switch
- 2-Then turn power switch to "ON"
...Screen will initialize and then display digital process notifications
- 3-After Initialization-
The red "STOP" lamp turns on
- 4-When red "STOP" button illuminates:
Quickly press it (no need to hold)
First programming screen will display:
"Grind Program A"

ON/OFF switch is located on lower right on back of grinder

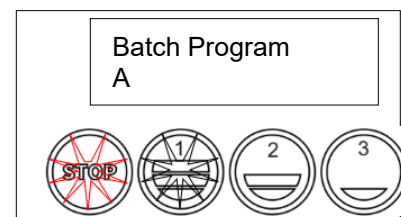
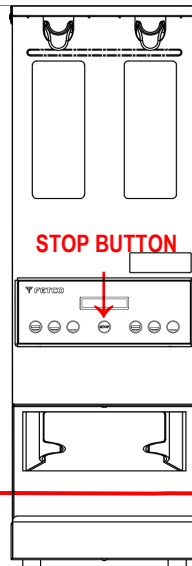

When grinder is in PROGRAMMING MODE -the screen will display:

|Grind Program|
|A (or B-F) |

-Illuminated LED shows active keypad positions

See the following pages for batch parameter definitions and all settings for the grinder

Layout for Programing Menu GRS-1220 series

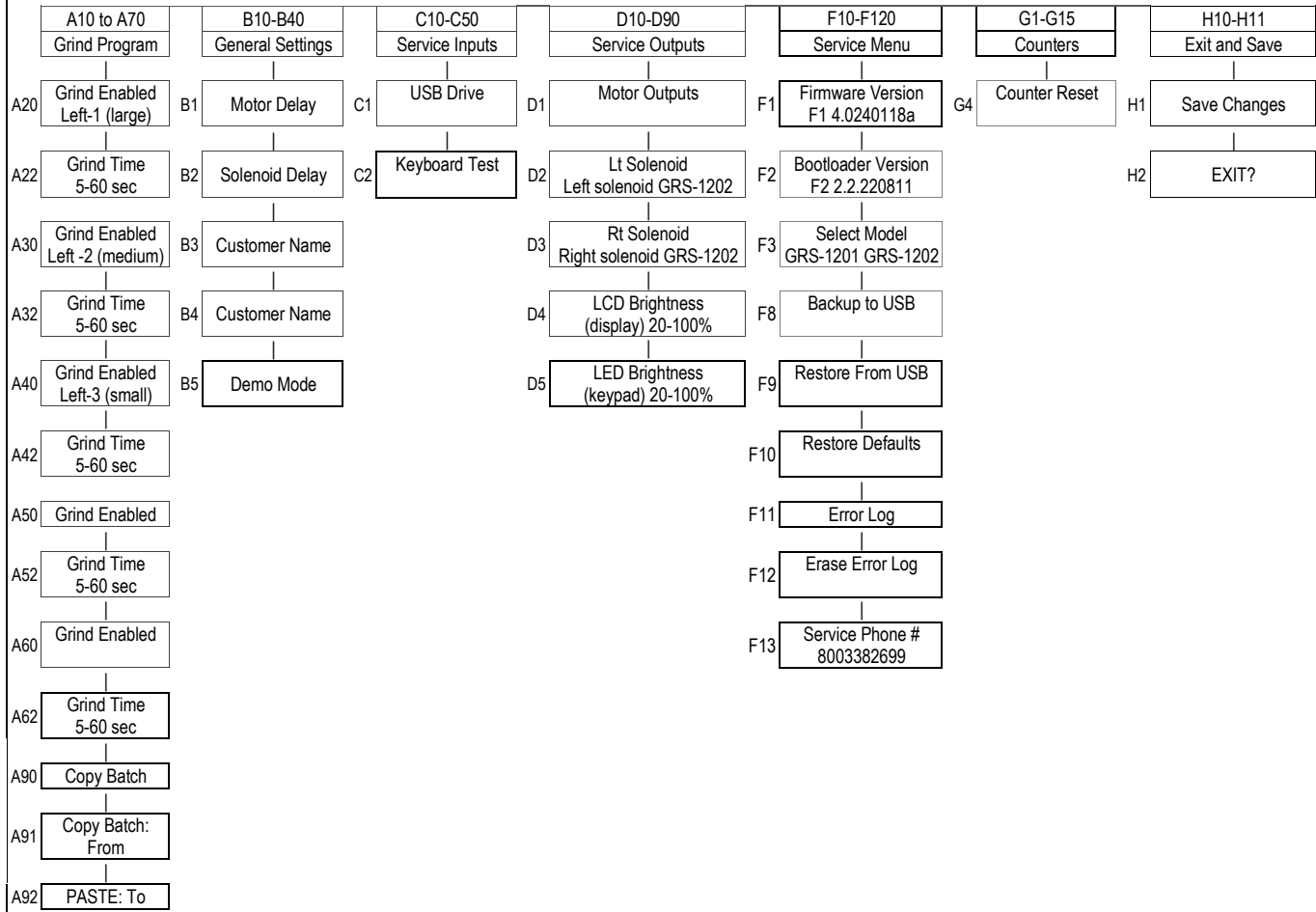

Factory default settings for grinder outputs

GRS-1201 -Single hopper Display↓				GRS-1202 -Dual hopper Display↓							
	Stop	Batch A1	Batch A2	Batch A3	Batch A1	Batch A2	Batch A3	Stop	Batch A4	Batch A5	Batch A6
DEFAULT		ON	ON	ON	ON	ON	ON	ON	ON	ON	ON
Selection		Permanent	Off/On User selectable	Off/On User selectable	Permanent	Off/On User selectable	Off/On User selectable	Permanent	Off/On User selectable	Off/On User selectable	Off/On User selectable
Default time		20sec	13sec	7seconds	20sec	13sec	7seconds	20sec	13sec	7seconds	
Default weight*		6oz or 170grams	4oz or 114grams	2.5oz or 70grams	6oz or 170grams	4oz or 114grams	2.5oz or 70grams	6oz or 170grams	4oz or 114grams	2.5oz or 70grams	

* Default weight is approximate based on medium grind with medium size, average to dark roast Arabica beans. Expect more variation when timer is ten seconds or less.

A Grinder Program

Menu Features: Setting Parameters

POSITION	Program Items	Factory set Default	Programming Range	Increments	Notes
A1:00	Grind Enabled Left 1 (large)	(Screen does not display)	5-60 sec	1sec	Always Enabled
A1.20	Grind Time	20sec (+20sec-see B1) 6oz or 170grams	5-60 sec	1sec	Adjustable 5-60 sec or 2oz/50g to 16oz/450g
A2.00	Grind Enabled Left-1 (large)	YES	YES/NO	On,Off	Can be turned Off/On
A2.20	Grind Time	13sec (+20sec-see B1) (4oz or 114grams)	5-60 sec	1sec	Adjustable 5-60 sec or 2oz/50g to 16oz/450g
A3.00	Grind Enabled Left -2 (medium)	YES	YES/NO	On,Off	Can be turned Off/On
A3.20	Grind Time	7sec. (+20sec-see B1) (2.5oz or 70grams)	5-60 sec	1sec	Adjustable 5-60 sec or 2oz/50g to 16oz/450g
A4.00 (GRS-1202 only)	Grind Enabled Right-1 (large)	(Screen does not display)	5-60 sec	1sec	Always Enabled
A4.20	Grind Time	20sec (+20sec-see B1) 6oz or 170grams	5-60 sec	1sec	Always Enabled Adjustable 5-60 sec or 2oz/50g to 16oz/450g
A5.00 (GRS-1202 only)	Grind Enabled Right-2 (medium)	YES	YES/NO	On,Off	Can be turned Off/On
A5.20	Grind Time	13sec(+20sec-see B1) (4oz or 114grams)	5-60 sec	1sec	Adjustable 5-60 sec or 2oz/50g to 16oz/450g
A6.00 (GRS-1202 only)	Grind Enabled Right-3 (small)	YES	YES/NO	On,Off	Can be turned Off/On
A6.20	Grind Time	7sec. (+20sec-see B1) (2.5oz or 70grams)	5-60 sec	1sec	Adjustable 5-60 sec or 2oz/50g to 16oz/450g
A90	Copy Batch		Select batch 1-6		
A92	Paste To		Select batch 1-6		

Batch Size	Typical Coffee Dosage		Timer setting
	Ounces*	Grams*	
½ Gallon	2 – 4 oz.	57 – 113 grams	6.7 - 13.3 sec.
2.5 – 3.0 Liters	2 - 4.5 oz.	57 – 128 grams	6.7 - 15 sec.
1 Gallon	4 – 8 oz.	113 – 227 grams	13.3 - 27 sec.
1.5 Gallons	6 – 12 oz.	170 – 340 grams	20 – 40 sec.
2 Gallons	8 – 16 oz.	227 – 454 grams	27 – 53 sec.
3 Gallons	12 – 24 oz.	340 – 680 grams	40 - 80 sec.
6 Gallons	39 – 51 oz.	1.1 – 1.44 kg.	130 -170 sec.

*Weights are approximate based on medium grind with medium size, average to dark roast Arabica beans. Expect more variation when timer is ten seconds or less

B General Settings		Grinder operation and controls settings			
POSITION	Program Items	Factory set Default	Programming Range	Increments	Notes
B1	Motor Delay*	20 seconds	0-60 seconds	1 sec.	GRS-1202 only. Shuts hopper/grinder is ON to empty grind chamber
B2	Solenoid Delay	1 second	0-2 seconds	1 sec.	Timer to pause hopper opening from motor start
B3	Customer Name	OFF	ON/OFF		Activates B4 name
B4	Customer Name	Enter letters			
B5	Demo Mode	OFF	ON/OFF		Operate keys alone

*GRS-1202 dual hopper only. Delay starts after timed grind is completed and shuts off the coffee hopper while the motor runs to completely empty the grind chamber. This prevents cross contamination from the contents of the two hoppers

C Service Inputs		Peripheral communication and keypad			
POSITION	Program Items	Factory set Default	Programming Range	Increments	Notes
C1	USB Drive	OFF	ON/OFF		Shows active USB
C2	Keyboard Test				Reboot when complete

D Service Outputs		Test motor, solenoids and set screen & button brightness			
POSITION	Program Items	Factory set Default	Programming Range	Increments	Notes
D1	Motor Output	OFF	OFF/ON		Shows motor ON/OFF
D2	Lt Solenoid Left solenoid GRS-1202 only	OFF	OFF/ON		Activate hopper solenoid and hopper solenoid SSR
D3	Rt Solenoid Right solenoid GRS-1202 only	OFF	OFF/ON		Activate hopper solenoid and hopper solenoid SSR
D4	LCD Brightness	90%	20% to 100%	5%	This is DISPLAY brightness
D5	LED Brightness	60%	20% to 100%	5%	This is BUTTON brightness

F Service Menu		Set Model Type, Software & View Codes and Settings			
POSITION	Program Items	Factory set Default	Programming Range	Increments	Notes
F1	Firmware Version	4.0240118a	January 2024		Software to program and operate all grinder functions
F2	Bootloader Version	2.2.220811	January 2024		Embedded BIOS to operate and update the firmware (BIOS basic input/output system)
F3	Select Model	Sold as GRS-1201 or GRS-1202	GRS-1201/GRS-1202		Factory set Reset if board is serviced
F8	Backup to USB	NO	Follow prompts		Save programmed settings
F9	Restore From USB	NO	Applies settings from USB		Insert USB Will need reboot
F10	Restore Defaults	NO	NO/YES		Restores settings to factory
F11	Error Log	Lists error codes	1: ;2: ;3: (1= newest)	Newest first	See chart for error code definitions
F12	Erase Error Log	NO		Toggle +/- YES or NO	FACTORY USE ONLY. DO NOT RESET
F13	Service Phone #	800-338-2699			Factory technical support

H Save & Exit

Saving changes and exiting PROGRAMMING

The grinder will save changes only from the "H" menu. **DO NOT** reboot grinder or toggle ON/OFF-Exit as below.

To exit programming & how to save control setting changes

HOW TO SAVE CHANGES AND EXIT-The grinder is in *PROGRAMMING mode*.

A convenient way to access the steps is to remember to scroll to EXIT→YES and scroll to SAVE →YES

Programming changes must be saved as shown below. Do not turn grinder off-all programming will be lost.

Exit Programming & Save

Control Setting Changes

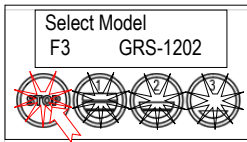

Model Selected
In "F" Screen
(GRS-1202 shown)
Press "STOP" 3X to
proceed to "SAVE"

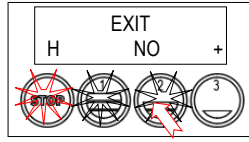

From the "H" screen
Press button 2 to
toggle to the EXIT-YES
screen.

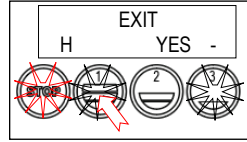

From EXIT screen
Press button 1 to
toggle to the SAVE
screen

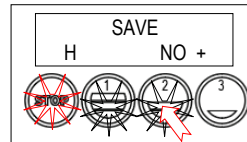

From SAVE screen
Press button 2 to
toggle to the SAVE-
YES screen

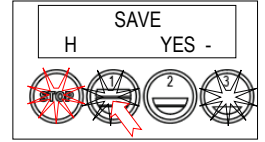

To SAVE and EXIT
Press button 1 to
SAVE your changes
and EXIT to
OPERATING MODE

NOTE: User programmed settings will be erased and overwritten to factory default settings by the following three programming changes

- 1) When setting grinder model →The software sets equipment to grinder defaults (SETTING F3)
- 2) When loading from USB (Reprograms settings) (SETTING F9)
- 3) When restoring defaults (Reloads to defaults) (SETTING E10)

Grinder service and maintenance

INSTALLATION, ADJUSTMENT AND SERVICE **THESE SECTIONS ARE FOR PROFESSIONAL USE ONLY!**

Danger of fire or electric shock-do not open panels. No user serviceable parts inside.
All adjustments and service to be performed by authorized professional personnel.

Grind Adjustment

Empty the hopper(s).

GRS 12001: Scoop out as many beans as possible. Lift the window up and sweep out the remaining beans.

GRS-1202: Remove both hoppers and dump the beans out. Place both hoppers back in grinder.

1. Press one of the large portion switches. This will clear the grinding chamber of any remaining beans.
2. Remove the front cover. There are 2 screws in front and 2 underneath near the coffee outlet.
3. Using a 7/8" or 22 mm wrench turn the retaining nut counterclockwise at least one turn.
4. Using a 3/8" to 1/2" standard screwdriver turn the adjustment screw clockwise for a finer grind, counterclockwise for a coarser grind. **Note:** Do not exceed more than a 1/4 turn in either direction.
5. Turn retaining nut clockwise, locking adjustment screw in place.
6. Grind a small amount of coffee beans to test the setting. Repeat the above steps if necessary.

To reset the grind setting to the factory default:

- Follow steps 1 - 4 of the grind adjustment procedure.
- Turn the adjustment screw clockwise until the grinding discs touch, then back off slightly.
- Using a marker, mark the twelve o'clock position of the adjustment screw.
- Turn the screw counterclockwise to just past the four o'clock position.
- Turn retaining nut clockwise locking adjustment screw in place.
- Test by grinding a small batch.

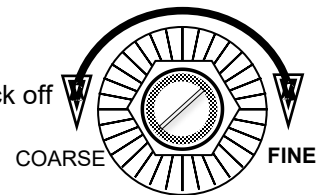

Note: It may be necessary to adjust the grind time to compensate for the new grind setting.

A finer grind will produce less ground coffee per minute and a coarser grind will produce more ground coffee per minute

Parts Diagrams

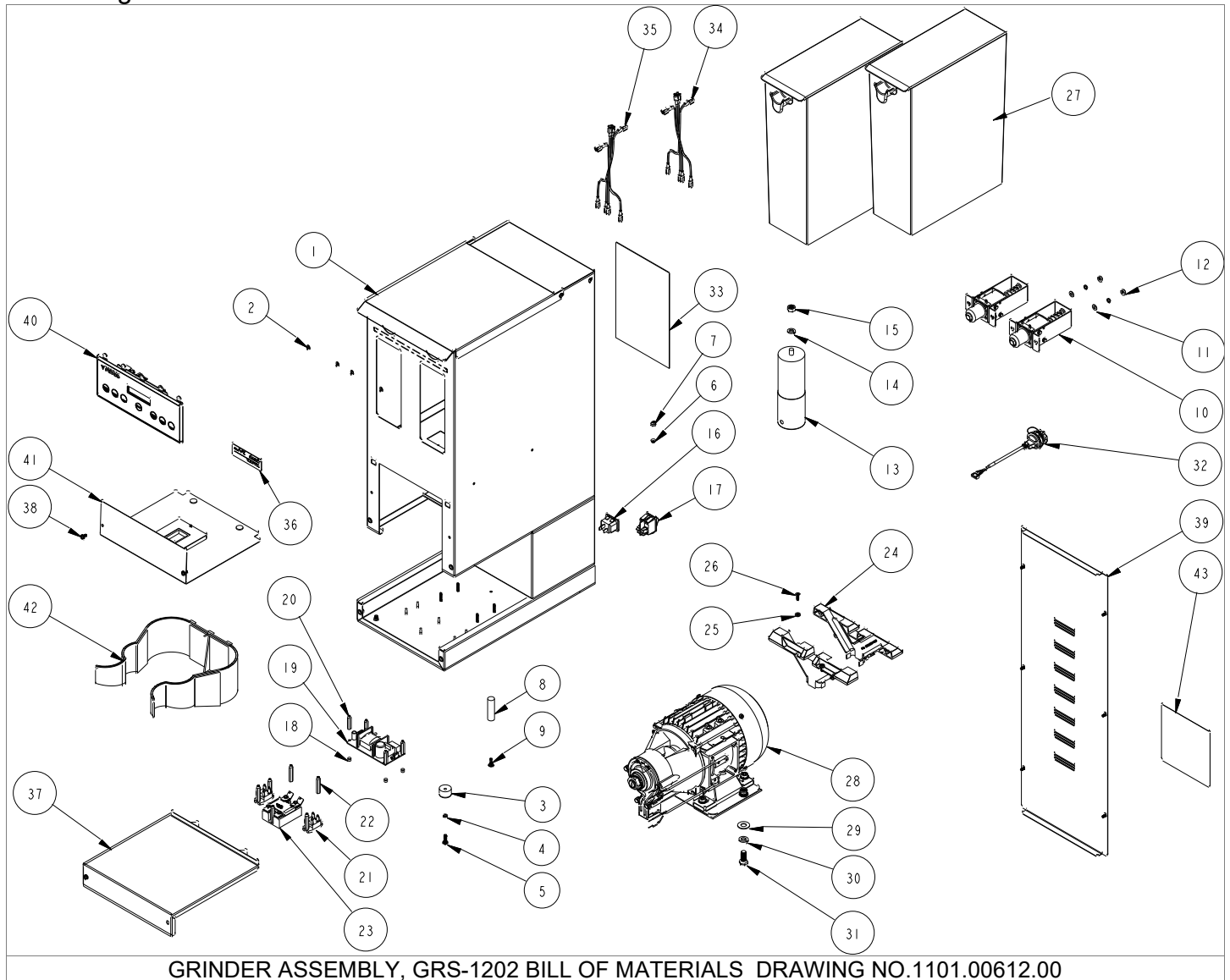

GRINDER ASSEMBLY, GRS-1202 BILL OF MATERIALS DRAWING NO.1101.00612.00

GRINDER ASSEMBLY, GRS-1202 BILL OF MATERIALS DRAWING NO.1101.00612.00			
#	QTY	PART NO	DESCRIPTION
1	1	1111.00117.00	BODY, WELDMET, GRS-1202
2	4	1029.00009.00	FASTENER, PUSH IN, 9/32" HD. DIA X .165" LG,
3	4	1073.00006.00	FOOT, GRINDER
4	8	1083.00019.00	WASHER, #10 SCREW SIZE, SPRING LOCK
5	4	1082.00031.00	SCREW, #10-32 X 5/8", PAN HD PHIL, MACHINE
6	1	1083.00011.00	WASHER, #8 SCREW SIZE, INTERNAL TOOTH LOCK
7	1	1084.00006.00	NUT, 8-32 18-8 HEX MACHINE SCREW
8	1	1021.00005.00	ROD, VIBRATION DAMPENING, GR-2
9	1	1082.00130.00	SCREW, TRUSS, HD, SELF TAPPING #8 X .500 SS
10	2	1102.00034.00	SOLENOID ASSEMBLY, 120VAC, GR-2
11	4	1083.00026.00	WASHER, #10 SCREW SIZE, FLAT
12	4	1084.00014.00	NUT, HEX, #10-32, MACHINE SCREW
13	1	1067.00001.00	CAPACITOR, 120VAC VERSION, 40uF, 450VAC, 50-60Hz
		67005	CAPACITOR, 230VAC VERSION, 18uF, 450VAC, 50Hz (EXPORT VERSION ONLY)
		1067.00005.00	CAPACITOR, 120VAC VERSION, 80uF, 450VAC, 50-60Hz (JAPAN VERS.-2 REQD.)
14	1	1083.00025.00	WASHER, M8 SCREW SIZE, SPRING LOCK
15	1	1084.00018.00	NUT, HEX, M8 SCREW SIZE
16	1	1065.00003.00	CONNECTOR, POWER INLET, 15A, 250VAC
17	1	1058.00024.00	SWITCH, POWER, DOUBLE POLE, 16A, 125/250 VAC
18	4	1081.00006.00	SPACER, 6MM OD x 3.2MM ID x 5MM LG, Z/P
19	1	1052.00001.00	POWER SUPPLY, 90-264VAC/24VDC, 1.8A
20	4	1029.00012.00	SPACER, .25" HEX X 1" LG, FEM #4-40 THREAD
21	2	1052.00056.00	RELAY, SOLID STATE, PANEL MTG. EL240A30-24P
22	6	1081.00042.00	STANDOFF, 1/4" HEX
23	1	1052.00033.00	RELAY, SOLID STATE, 50A/480VAC, W/BUILD IN VARISTOR
24	2	1023.00044.00	MANIFOLD, GR-2
25	4	1083.00010.00	WASHER, #12 SCREW W/NEOPRENE-BONDED SEAL
26	4	1082.00017.00	SCREW, TRUSS HD. PHIL. MACHINE, # 6-32 X 1/2 LG.
27	2	1102.00033.002	HOPPER, ASSEMBLY, GR-2 [ORDER AS A066]
28	1	1102.00038.00	GRINDING MOTOR AND PLATE ASSY, 120V/60Hz
28	1	1102.00185.00	COMPLETE GRINDING MOTOR ASSEMBLY, 230VAC/50Hz
29	2	1083.00022.00	WASHER, 3/8" SCREW SIZE, FLAT
30	2	1083.00020.00	WASHER, SPRING LOCK, 3/8 SCREW, 18-8 SS
31	2	1082.00032.00	SCREW, 3/8"-16 X 3/4" LG, HEX HEAD CAP
32	1	1058.00055.00	USB CONNECTOR
33	1	1401.00203.00	WIRING DIAGRAM, GRS-1200, L-N-PE, UNIVERSAL
34	1	1402.00125.00	HARNESS, GRS-1200, UNIVERSAL
35	1	1402.00125.01	HARNESS, GRS-1202, ADDITIONAL
36	1	1041.00035.00	LABEL, EXACTOR PLUS GRINDING SYSTEM
37	1	1112.00023.00	BASE COVER WELDMENT, GR/GRF
38	10	1082.00033.00	SCREW, PAN HD PHIL. MACH., W/DUAL ACT WASHER, #6-32x3/8LG.
39	1	1001.00035.00	COVER, REAR, GR-2
40	1	1102.00534.00	ASSEMBLY, FRONT PANEL, GRS-1202
41	1	1102.00533.00	COVER, GRS-1200 SERVICE ASSEMBLY, W/O RAILS
42	1	1023.00041.00	HOLDER, BREW BASKET, GR-1/2
43	1	1046.00035.00	LABEL, WARNING "TO REDUCE RISK OF ELECTRIC SHOCK OR FIRE"
	1	1063.00003.00	CORD, POWER, AMERICAN, 120VAC, 13A, 6FT LG.
	1	1063.00027.00	CORD, ENGLAND, 6.5FT
	1	1063.00026.00	CORD, AUSTRALIAN, 6.5FT
	1	1063.00025.00	CORD, EUROPEAN, 6.5FT
	1	1063.00028.00	CORD, SOUTH AFRICA, 6.5FT

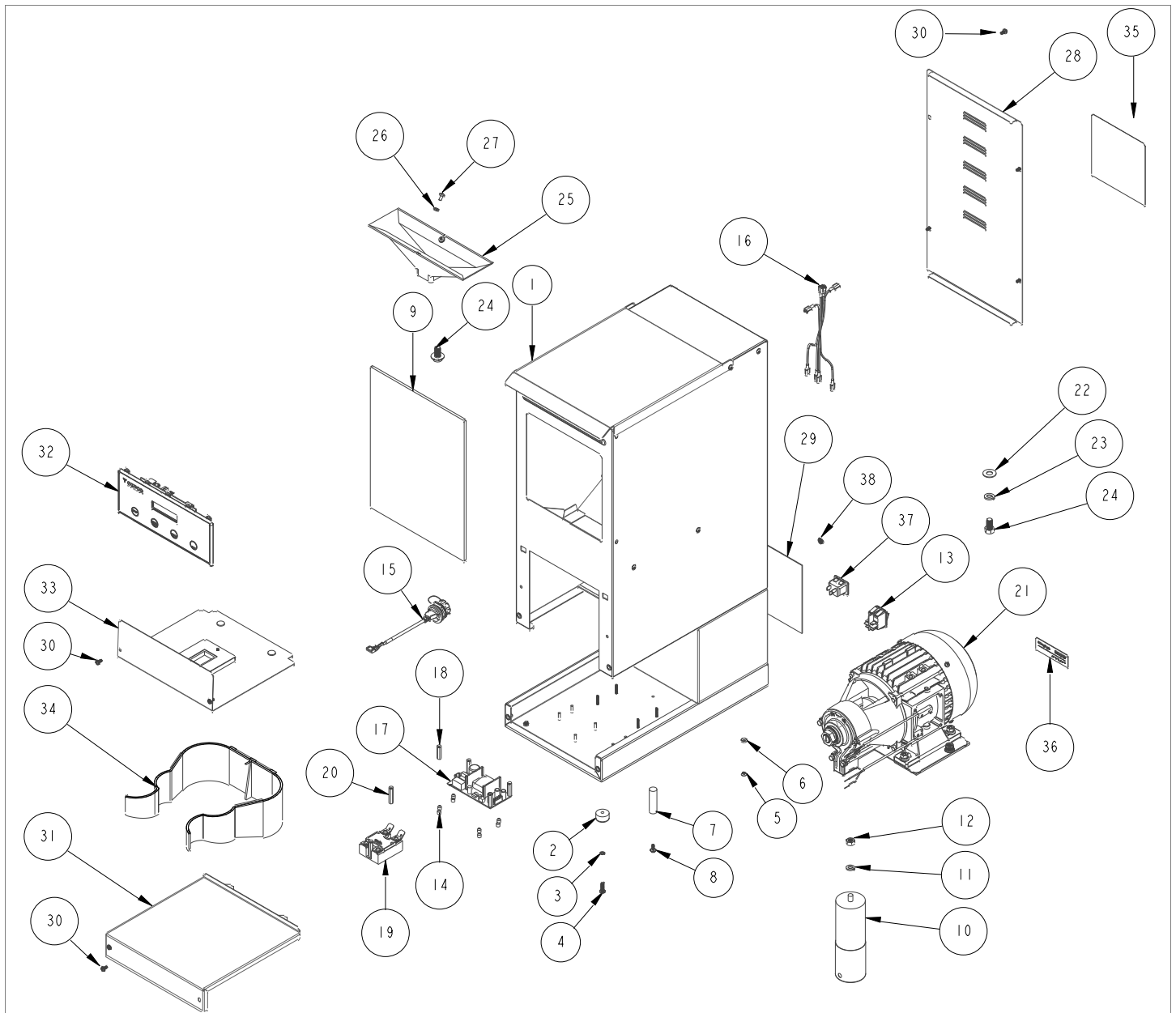

GRINDER ASSEMBLY, GRS-1201 BILL OF MATERIALS DRAWING NO.1101.00613.00

GRINDER ASSEMBLY, GRS-1201 BILL OF MATERIALS DRAWING NO.1101.00613.00			
#	QTY	PART NO	DESCRIPTION
1	1	1111.00118.00	WELDMENT BODY, GRINDER; COMPLETE, GRS-1201,120VAC
2	4	1073.00006.00	FOOT, GRINDER
3	4	1083.00019.00	WASHER, #10 SCREW SIZE, SPRING LOCK
4	4	1082.00031.00	SCREW, #10-32 X 5/8", PAN HD PHIL, MACHINE
5	1	1083.00011.00	WASHER, #8 SCREW SIZE, INTERNAL TOOTH LOCK
6	1	1084.00006.00	NUT, 8-32 18-8 HEX MACHINE SCREW
7	1	1021.00005.00	ROD, VIBRATION DAMPENING, GR-2
8	1	1082.00130.00	SCREW, TRUSS, HD, SELF TAPPING #8 X .500 SS
9	1	1028.00001.00	WINDOW, GR-1
10	1	1067.00001.00	CAPACITOR, 120VAC VERSION, 40uF, 450VAC, 50-60Hz
		67005	CAPACITOR, 230VAC VERSION, 18uF, 450VAC, 50Hz (EXPORT VERSION ONLY)
		1067.00005.00	CAPACITOR, 120VAC VERSION, 80uF, 450VAC, 50-60Hz (JAPAN VERS.-2 REQD.)
11	1	1083.00025.00	WASHER, M8 SCREW SIZE, SPRING LOCK
12	1	1084.00018.00	NUT, HEX, M8 SCREW SIZE
13	1	1058.00024.00	SWITCH, POWER, DOUBLE POLE, 16A, 125/250 VAC
14	8	1081.00006.00	SPACER, 6MM OD x 3.2MM ID x 5MM LG, Z/P
15	1	1058.00055.00	USB CONNECTOR
16	1	1402.00125.00	HARNESS, GRS-1200, UNIVERSAL
17	1	1052.00001.00	POWER SUPPLY, 90-264VAC/24VDC, 1.8A
18	4	1029.00012.00	SPACER, .25" HEX X 1" LG, FEM #4-40 THREAD
19	1	1052.00033.00	RELAY, SOLID STATE, 50A/480VAC, W/BUILD IN VARISTOR
20	2	1081.00042.00	STANDOFF, 1/4" HEX
21	1	1102.00038.00	GRINDING MOTOR AND PLATE ASSY, 120V/60Hz
22	2	1083.00022.00	WASHER, 3/8" SCREW SIZE, FLAT
23	2	1083.00020.00	WASHER, SPRING LOCK, 3/8 SCREW, 18-8 SS
24	2	1082.00032.00	SCREW, 3/8"-16 X 3/4" LG, HEX HEAD CAP
25	1	1023.00148.00	FUNNEL, HOPPER, GR-1
26	2	1083.00010.00	WASHER, #12 SCREW W/NEOPRENE-BONDED SEAL
27	2	1082.00023.00	SCREW, #8-32 X 3/8 TRUSS HD PHIL., MACHINE
28	1	1001.00020.00	COVER, REAR, GR-1/GRF-2
29	1	1401.00203.00	WIRING DIAGRAM, GRS-1200, L-N-PE, UNIVERSAL
30	8	1082.00033.00	SCREW, PAN HD PHIL. MACH., W/DUAL ACT WASHER, #6-32x3/8LG.
31	1	1112.00023.00	BASE COVER WELDMENT, GR/GRF
32	1	1102.00536.00	ASSEMBLY, FRONT PANEL, GRS-1201
33	1	1102.00533.00	COVER, GRS-1200 SERVICE ASSEMBLY, W/O RAILS
34	1	1023.00041.00	HOLDER, BREW BASKET, GR-1/2
35	1	1046.00035.00	LABEL, WARNING "TO REDUCE RISK OF ELECTRIC SHOCK OR FIRE"
36	1	1041.00035.00	LABEL, EXACTOR PLUS GRINDING SYSTEM
37	1	1065.00003.00	CONNECTOR, POWER INLET, 15A, 250VAC
38	1	1084.00051.00	NUT, HEX LOCKWASHER, #8-32, 18-8 ST. STL.
	1	1063.00003.00	CORD, POWER, AMERICAN, 120VAC, 13A, 6FT LG.
	1	1063.00027.00	CORD, ENGLAND, 6.5FT
	1	1063.00026.00	CORD, AUSTRALIAN, 6.5FT
	1	1063.00025.00	CORD, EUROPEAN, 6.5FT
	1	1063.00028.00	CORD, SOUTH AFRICA , 6.5FT

GRS-1200 Motor Assembly.

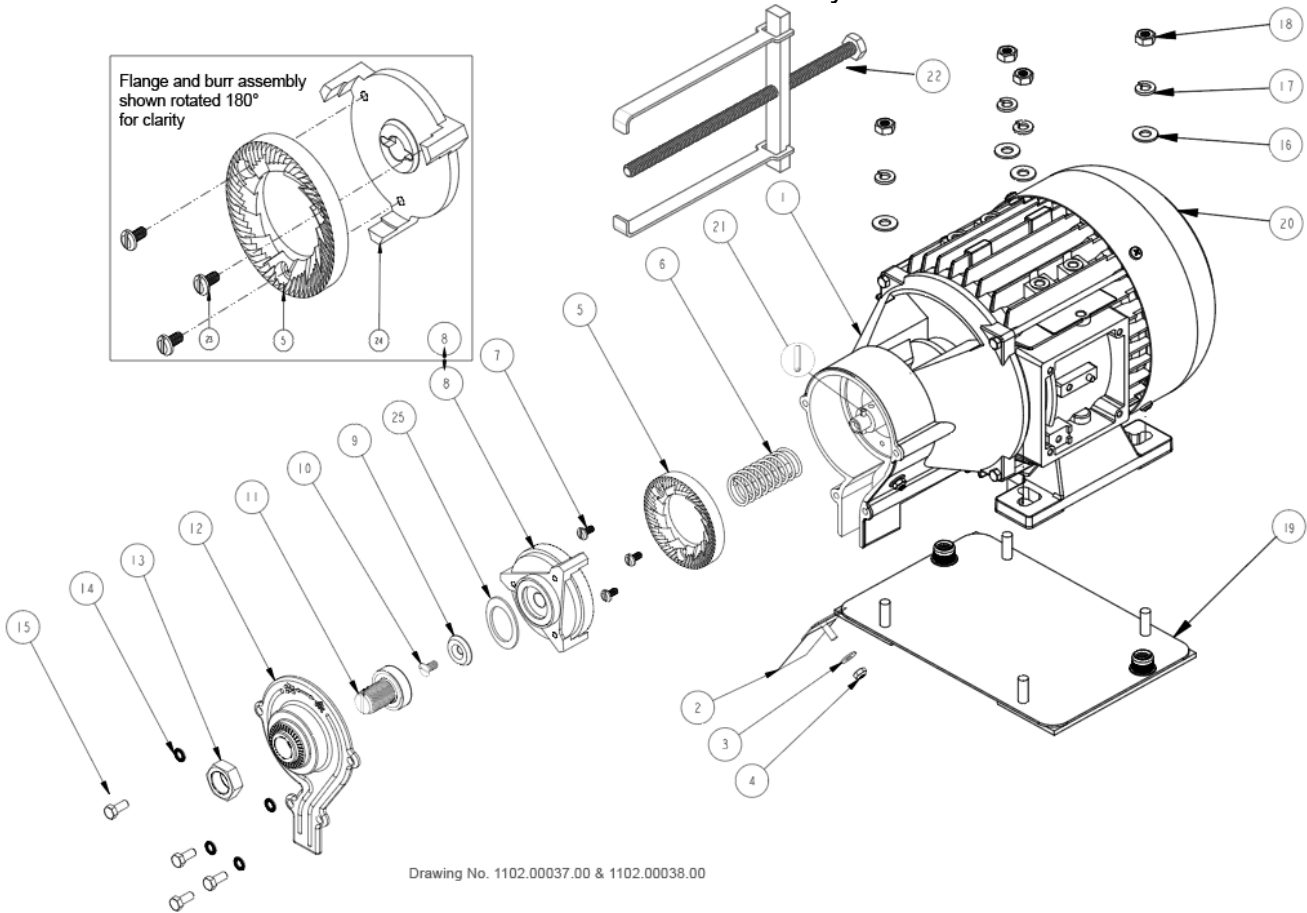

Ref.	#	PART NO	DESCRIPTION
1	1	1102.00029.00	GRINDING CHAMBER ASSEMBLY WITH 120VAC/60Hz MOTOR
1	1	1102.00030.00	GRINDING CHAMBER ASSEMBLY WITH 230VAC/50Hz MOTOR EXPORT ONLY
2	1	1112.00035.00	GUIDE COFFEE FLOW, WELDMENT, GR
3	1	1083.00016.00	WASHER, #8 SCREW SIZE, FLAT
4	1	1084.00015.00	LOCKNUT, #8-32 SCREW SIZE, HEX THIN NYLON INSERT
5	2	1014.00005.00	DISC, GRINDING, 64 MM DIA (One burr attached to a complete rotating disc flange)
		1000.00085.00	KIT: DISC, GRINDING, 64 MM DIA (Kit of two burrs)
		1000.00141.00	KIT: DISC, GRINDING, 64 MM DIA (Kit of two burrs and #22 burr puller)
6	1	1085.00002.00	SPRING, GRINDER AUGER, 6 MM PITCH
7	3	1082.00026.00	SCREW, M4 X 10, PAN HEAD, SLOTTED
8	1	1102.00032.00	FRONT GRINDING DISC ASSEMBLY, GR (Flange and burr assembled)
9	1	1013.00021.00	WASHER, GR1/GR2 COUNTERSUNK
10	1	1082.00027.00	SCREW, M5 X 10, FLAT HEAD, SLOTTED
11	1	1102.00036.00	SHAFT AND BEARING ASSEMBLY
12	1	1015.00005.00	COVER , GRINDING CHAMBER HSG, MACHINED
13	1	1084.00016.00	NUT, M16x1 JAM
14	4	1083.00017.00	WASHER, M5, SERRATED BELLEVILLE
15	4	1082.00028.00	SCREW, M5 X 12, HEX HEAD
16	4	1083.00023.00	WASHER, 1/4" SCREW SIZE, FLAT
17	4	1083.00021.00	WASHER, 1/4" SCREW SIZE, SPRING LOCK
18	4	1084.00017.00	NUT, HEX, 1/4"-20
19	1	1102.00035.00	PLATE ASSEMBLY, GRINDER MOTOR
20	1	1102.00037.00	COMPLETE GRINDING MOTOR ASSEMBLY, 120VAC/60Hz
20	1	1000.00078.00	COMPLETE GRINDING MOTOR ASSEMBLY, 230VAC/50Hz
21	1	1087.00003.00	PIN, SLOTTED SPRING, M3x14mm
22		1105.00005.00	Burr Puller, (not included, sold only as an aftermarket accessory)
23	3	1082.00026.00	SCREW, M4 X 10, PAN HEAD, SLOTTED
24	1	1102.00031.00	ROTATING DISC, FLANGE & WASHER, ASSEMBLY, GR
25	1	1083.00015.00	RUB WASHER, 1.25"OD X 0.900"ID, FLAT (-requires RED Loctite®)

GRS-1202 Hopper Assembly, Part # 1109.00019.00 [ORDER AS [A066](#)]

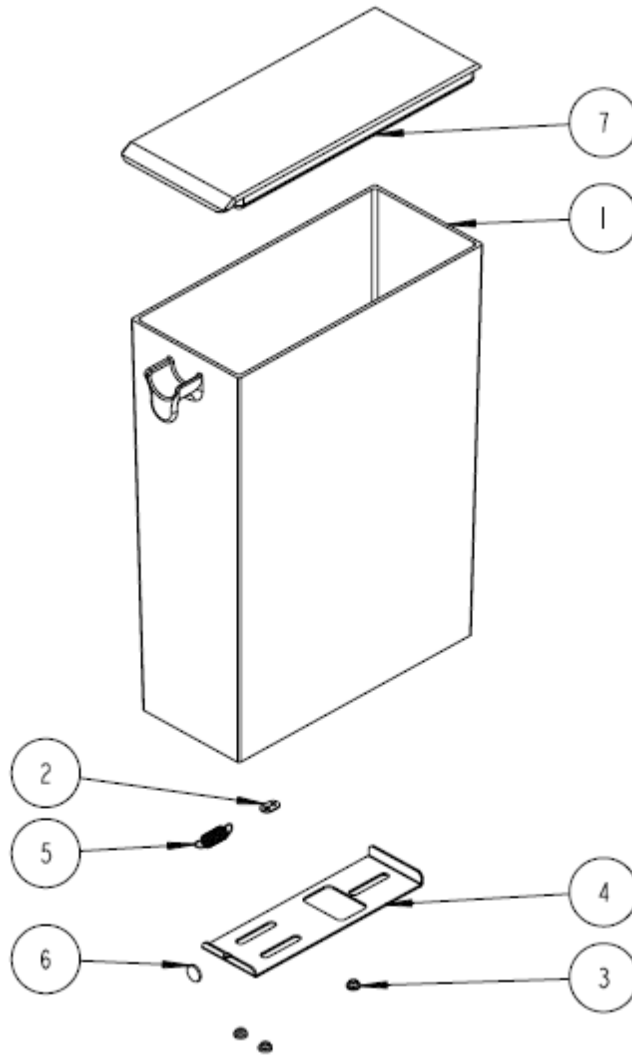

Hopper Parts List [A066](#) – GRS-1202

Ref	QTY	PART NO.	DESCRIPTION
1	1	Sold as A066 1021.00034.00 (MFG use only)	BODY, HOPPER, GR-2
2	1	1003.00035.00	BRACKET, GUILLOTINE SPRING, GR-2
3	3	1029.00008.00	WASHER, SHOULDER, NYLON
4	1	1003.00034.00	GUILLOTINE, GR-2
5	1	1085.00003.00	SPRING, EXPANSION, 3/8"OD X .026"W X 1.375"L, 0.60 LB/IN
6	1	1097.00013.00	BUMPER, 1/2" DIA, FLAT TOP, ADHESIVE BACKED, BLK
7	1	1023.00043.00	LID, HOPPER, GR-2

Wiring Diagram

LEGEND:

- * — WIRE NUT CONNECTION
- - - - - OPTIONAL CIRCUIT

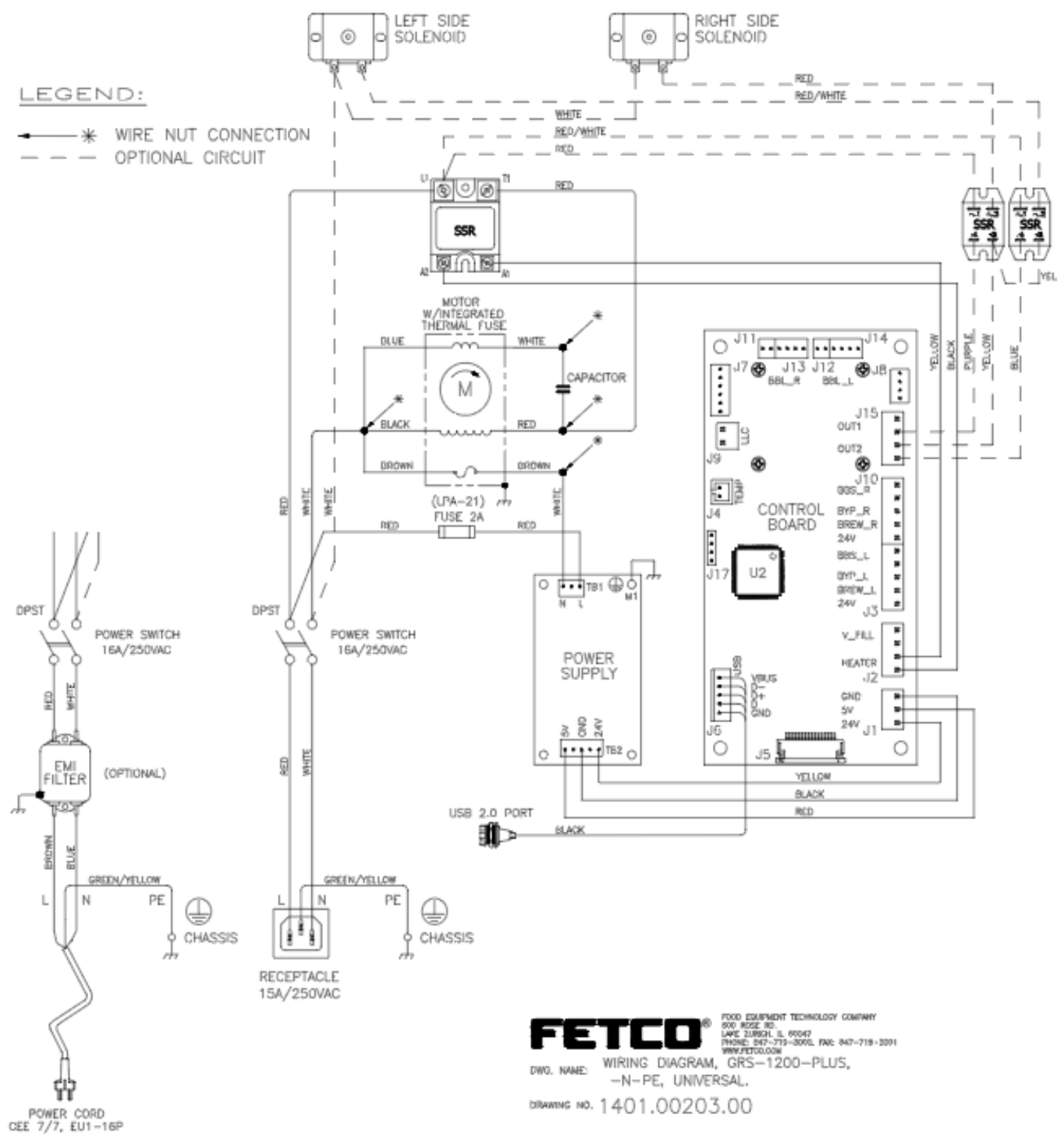

FETCO® FOOD EQUIPMENT TECHNOLOGY COMPANY
 600 ROSS RD.
 LAKE ZURICH, IL 60047
 PHONE: 247-779-3000, FAX: 247-719-3001
 WWW.FETCO.COM

DWG. NAME: WIRING DIAGRAM, GRS-1200-PLUS,
 -N-PE, UNIVERSAL.

DRAWING NO. 1401.00203.00