

**MBS-1221 Multi Beverage Combination Brewer for Coffee, Iced Tea, Hot Tea**  
FETCO Commercial Beverage Equipment



FETCO MBS 1221-with brew shelf and MBS122S (not shown)



**CONTACT INFORMATION**

FETCO® FOOD EQUIPMENT TECHNOLOGIES COMPANY  
600 ROSE ROAD  
LAKE ZURICH • IL • 60047-0429 • USA  
INTERNET: [www.fetco.com](http://www.fetco.com)  
©2021 FOOD EQUIPMENT TECHNOLOGIES COMPANY  
PATENTS: <https://www.fetco.com/pl/pages/patents,74.html>



fetco.com

PHONE: (800) 338-2699 (US & CANADA)  
(847) 719-3000 (All Countries)  
FAX: (847) 719-3001  
EMAIL: [sales@fetco.com](mailto:sales@fetco.com)  
[orders@fetco.com](mailto:orders@fetco.com) (to order parts and equipment)  
[techsupport@fetco.com](mailto:techsupport@fetco.com) (all service queries)

P202

August 2024

Multi Beverage Brewer: MBS-1221

**TABLE OF CONTENTS**

Specifications and Requirements.....	2	G COUNTERS .....	13
A PROGRAM .....	6	Operator Training .....	15
B GENERAL .....	7	Inlet & Dilution Valve Notes .....	17
C SERVICE INPUTS.....	8	Wiring Diagram .....	19
D SERVICE OUTPUTS.....	8	Parts Diagrams .....	22
E CALIBRATION .....	9	Small Spray Head Assembly .....	28
F SERVICE MENU.....	11	Hot Water Faucet Relocation Instructions .....	30

## Specifications and Requirements

### Water Requirements:

**Water inlet fitting** Dual Water Inlet Connector Assembly is included (page 16) terminates to a 1/4 inch male flare

**Pressure:** 20-75 psig, (138-517kPa) 1½gpm/(5.7lpm)

For Iced tea: brewer is factory calibrated to a non-fluctuating stable water supply pressure at 45 psi.

**Water supply: (Optimal) 100-150TDS**

All beverage equipment must use filtered water

**Brew Volume-Coffee: Full Batch** 2.20 liters

User adjustable to up to 0.85 gallon/3.25 liters per brew

**Brew Volume-Iced Tea: Full Batch** 11.40 liters/3 gallons

User adjustable to up to 4.9 gallon/18.7 liters per brew

Brew batch and dilution ratio user adjustable

**Total Brew Cycle**—Factory default setting (Batch 1): 5 minutes=[3:30 minute brew time + 1:30 minute drip delay]

Iced Tea-(Batch 3) 4:30 minutes=[3:00 minute brew time + 1:30 minute drip delay] Batch 2 may be set for either

**Brew-Process parameters are user controllable for:** Brew Volume, Brew Time, Prewet Percent and Delay, Drip Delay, Tea Batch Temperature, Dilution Volume and Dilution Timing (with brew or after brewing)

**Electrical:** Supplied with 120V cord & plug  
User adjustable to 220-240 volt terminal block

**Tank Temperature, as set by factory:**

200°F (93°C) inside water tank (at sea level)

**Iced Tea Batch Temperature**-user adjustable

200°F-207°F- / 93°-98°C

**Iced Tea Dilution Ratio: 1:4** factory set brew to water

Factory setting adds 2.4 gallons of cold water to 0.6

gallon brew for a 1:4 ratio Iced tea

(2.3liter brew/9.1 liter dilution)

Dilution volume is user adjustable from 0-4Gal;0-15.2L

### Electrical Specifications for domestic-dual voltage Standard height with brew shelf

SKU Model description	Electrical Connection	Brew Basket	Heater Configuration	Voltage	KW	Amp Draw	Brew Volume/Hour
M1221US-1A117-PM001	NEMA 15-5P	Plastic tea "A" Plastic coffee "B"	1 X 1.7 kW	120	1.7	14.7	4.4 gal/16.5 liters
M1221US-1A117-MM001	NEMA 15-5P	Plastic tea "A" Metal coffee "C"	1 X 1.7 kW	120	1.7	14.7	4.4 gal/16.5 liters
M1221US-1X117-PM001 Domestic-Dual Voltage	NEMA 15-5P Terminal Block	Plastic tea "A" Plastic coffee "B"	1 X 1.7 kW 1 X 3.0 kW	100-120 200-240	1.3-1.8 2.2-3.1	12.3-14.7 10.9-13.0	4.4 gal/16.5 liters 6-7 gal/22-21 liters
M1221US-1X117-KM001 Domestic-Dual Voltage	NEMA 15-5P Terminal Block	Plastic tea "A" Plastic coffee "B"	1 X 1.7 kW 1 X 3.0 kW	100-120 200-240	1.3-1.8 2.2-3.1	12.3-14.7 10.9-13.0	4.4 gal/16.5 liters 6-7 gal/22-21 liters
M1221US-1X117-MM001 Domestic-Dual Voltage	NEMA 15-5P Terminal Block	Plastic tea "A" Metal coffee "C"	1 X 1.7 kW 1 X 3.0 kW	100-120 200-240	1.3-1.8 2.2-3.1	12.3-14.7 10.9-13.0	4.4 gal/16.5 liters 6-7 gal/22-21 liters

### Electrical Specifications for domestic-dual voltage Short version - no brew shelf

SKU Model description	Electrical Connection	Brew Basket	Heater Configuration	Voltage	KW	Amp Draw	Brew Volume/Hour
M122SUS-1X117-PM001 Domestic-Dual Voltage	NEMA 15-5P Terminal Block	Plastic tea "D" Metal coffee "F"	1 X 1.7 kW 1 X 3.0 kW	100-120 200-240	1.3-1.8 2.2-3.1	12.3-14.7 10.9-13.0	4.4 gal/16.5 liters 6-7 gal/22-21 liters



Factory supplied with 120 volt NEMA 5-15 cord and plug. Dual voltage brewers may be field converted to 200-240 volts-see pages 13 and 19

### International

SKU	Electrical Connection	Brew Basket	Heater Configuration	Voltage	KW	Amp Draw	Brew Volume/Hour
M1221IN-1B130-PM005	CEE 7/7	Plastic tea "A" Plastic coffee "B"	1 X 3.0 kW	200-240	2.1-3.0	10.9-13.0	4.4 gal/16.5 liters
M1221CE-1B130-PM005	CEE 7/7	Plastic tea "A" Plastic coffee "B"	1 X 1.7 kW	230	2.8	12.5	4.4 gal/16.5 liters
M1221CE-1B130-PM006	UK1-13P	Plastic tea "A" Plastic coffee "B"	1 X 1.7 kW	230	2.8	12.5	4.4 gal/16.5 liters
M1221NM-1X117-PM001 DUAL VOLTAGE	NEMA 15-5P Terminal Block	Plastic tea "A" Plastic coffee "B"	1 X 1.7 kW 1 X 3.0 kW	100-120 200-240	1.3-1.8 2.2-3.1	12.3-14.7 10.9-13.0	4.4 gal/16.5 liters 6-7 gal/22-21 liters
M1221KS-1B130-PM006	UK1-13P	Plastic tea "A" Plastic coffee "B"	1 X 1.7 kW	230	2.8	12.5	4.4 gal/16.5 liters
M1221BR-1B130-PN008	Type N	Plastic tea "A" Plastic coffee "B"	1 X 1.7 kW	230	2.8	12.5	4.4 gal/16.5 liters

### NOTES:

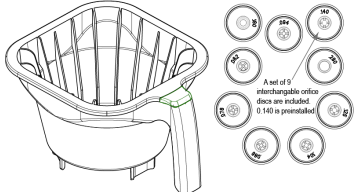
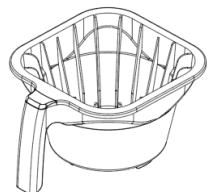
- Advanced electronics enable this equipment to operate with a 50-60 Hz frequency range without affecting the circuit or requiring user adjustments.
- NM in SKU suffix (above) denotes equipment with NOM certification, Spanish labeling for Mexico and Spanish language user guide
- The "KS" in the SKU suffix indicates GCC equipment with CB Scheme certification, labeling for KSA, and Arabic language user guide.
- The "BR" in the SKU suffix indicates Brazil equipment with CB Scheme certification, Type N plug, labeling and Portuguese for Brazil language user guide.
- The "CE" in the suffix (above) indicates equipment with a current CB scheme supporting CE marking. This equipment is not cUL/UL certified

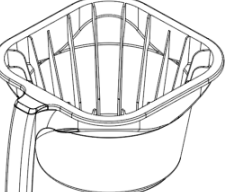
MBS-1200 plastic Basket type "A"	MBS-1200 plastic Basket type "B"	MBS-1200 metal Basket type "C"	MBS-1200 SHORT plastic Basket type "D"	MBS-1200 SHORT plastic Basket type "E"
				
TEA MBS-1200 Plastic 13"X5"basket (Green plug) # B026000G2BK Set of 9 orifices 13" X 5 Filter Paper or FETCO# F002	COFFEE MBS-1200 Plastic 13"X5" (Brown plug) #B014218BN2BK 0.218" orifice 13" X 5 Filter Paper or FETCO# F002	COFFEE MBS-1200 Stainless steel 13"X5" Black handle B003218B10 218" orifice 13" X 5 Filter Paper or FETCO# F002	TEA MBS-1200-SHORT Plastic 16"X6"(Green plug) # B015140G2BK 0.140" orifice 15" X 5 ½ Filter Paper or FETCO# F001	COFFEE MBS-1200-SHORT Plastic 16"X6"(Brown plug) #B015280BN2BK 0.280" orifice 15" X 5 ½ Filter Paper or FETCO# F001

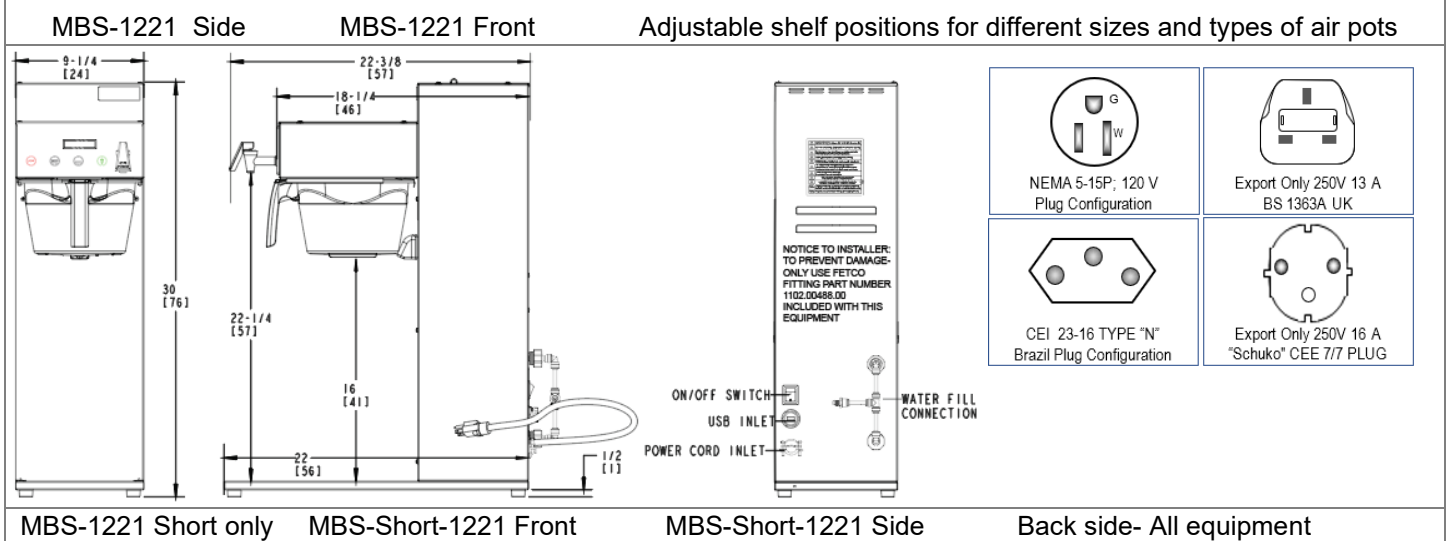
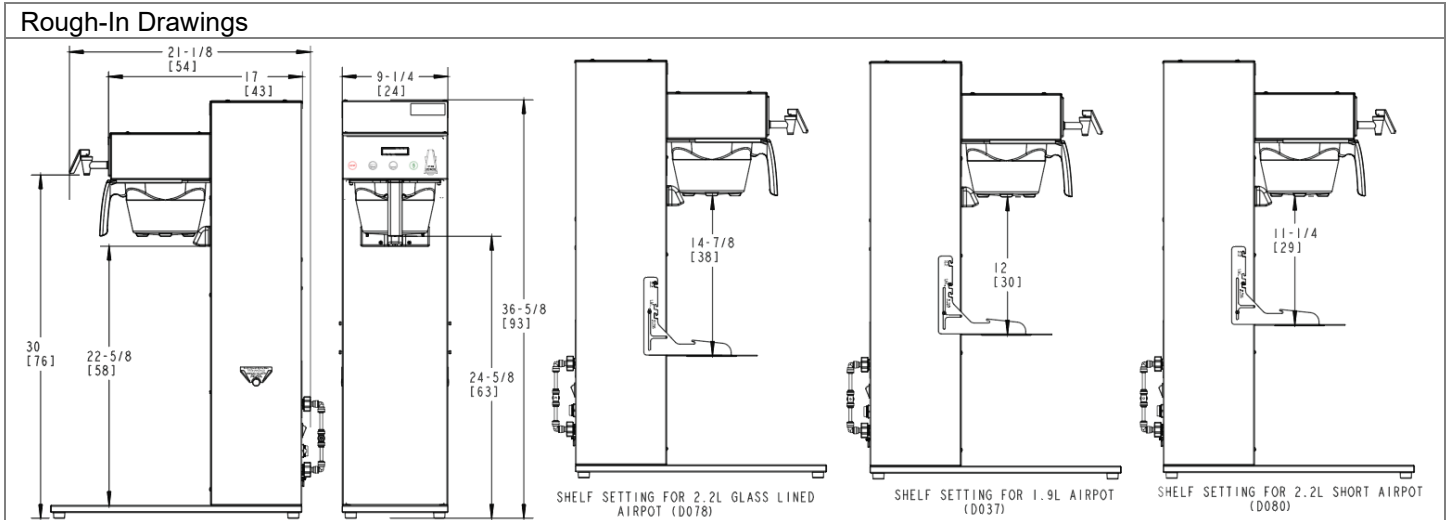

**Weights and Capacities**

Dispenser Model	Height	Width	Depth	Water tank capacity	Empty Weight	Filled Weight	Shipping Weight	Shipping Dimensions
MBS-1221 Brewer	37 in 940 mm	9 1/4 in 235 mm	17 in 440 mm	2.7 gallon 10.1 L	35bs. 15.9 kg	60 lbs. 27.2 kg	50 lbs. 22.7 kg	27" x 11.5" x 39" 681mmX292X991mm
MBS-1221 Short	30 in 762 mm	9 1/4 in 235 mm	18 1/4 in 464 mm	2.7 gallon 10.1 L	33bs. 15 kg	57 lbs. 25.9 kg	48 lbs. 21.8 kg	27" x 11.5" x 39" 681mmX292X991mm

Calibrated for  
2.2 L/74 oz/0.58gal Coffee air pot (Batch 1)  
3 gal 11.4 liter Iced Tea (Batch 3)

Coffee dose calibrated for 120g/4.2oz  
Range: 100-140 gram 3.5-4 ounce dose  
Tea dose range: 70-113 gram/2.5-4.0 oz

## To Start the Brew

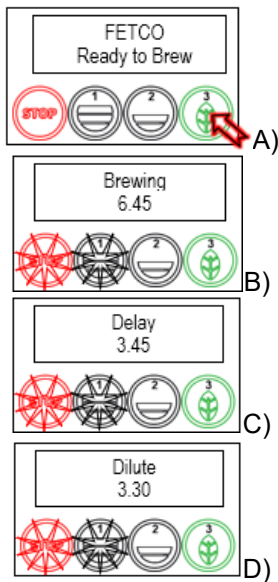

Showing brewing iced tea with button #3. Button #2 is blank as delivered from the factory. Button 1 is for coffee.

The brewer install is complete – it is plumbed to a water line, filled, and the hot water tank is heated

1. Turn the power switch “ON”.
2. Prepare a brew basket with the correct size filter and appropriate amount of tea.
3. Slide the brew basket completely into the rails.
4. Place a clean, empty, 3½ gallon dispenser under the brew basket.

(III A) Select a batch & hold the corresponding BREW button in for 1 second to start  
STOP button will illuminate and Brew Selector button will illuminate

(III B) Countdown time will display. Default time setting is 6:45(iced tea)  
-Selected BREW button will slowly pulsate to indicate brew is in progress.  
-All other BREW buttons for that brew head will be unlit.

(III C) Dilute DELAY cycle will activate at 3:45

(III D) Dilute will activate at 3:30.

Brew is completed after the 3 ½ minute dilution cycle and times out.

Upon time out, brewer will return to “READY” for next batch

STOP button will extinguish and the Batch one BREW button will illuminate on completion  
For safety- do not remove brew basket until drip-out is complete.

## To Enter Programming

There are 7 menu groups-A-F plus EXIT (G).

See the following pages for the batch parameter definitions and all settings for the brewer

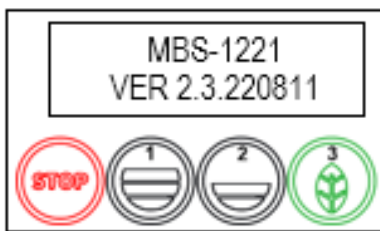

### TO ENTER PROGRAMMING

- 1-Turn brewer “OFF” from power switch
  - 2-Turn power switch to “ON”
- ...Screen will initialize and then display digital process notifications
- 3-After Initialization-the “STOP” LED Lamp turns on
  - 4-Quickly press red “STOP” button (no need to hold)
- ...Brewer will enter PROGRAMMING MODE

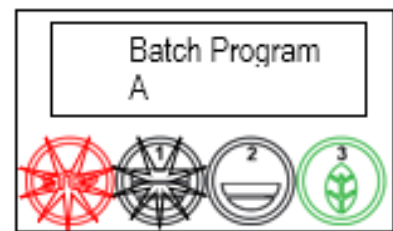
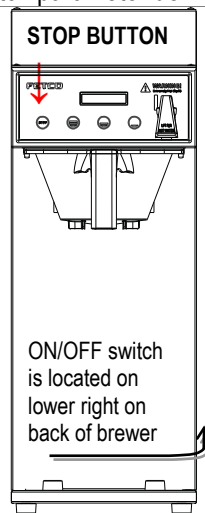

### When brewer is In PROGRAMMING MODE

-the screen will display:

**BATCH PRG**  
**A (or B-F)**

-Illuminated LED indicates active keypad positions

See the following pages for batch parameter definitions and all settings for the brewer

## Making changes in Programming

Section B –“General Settings” to change tank temperature shown below

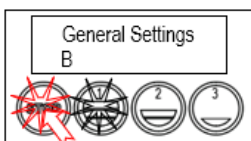

Enter Programming-Press STOP button until the General Settings (“B”) screen appears

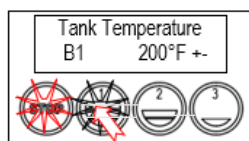

From the “B” screen Press button **1** to toggle to the Tank Temperature Screen (default is 200°)

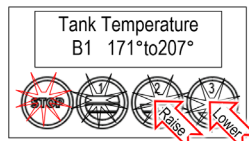

From Tank Temp screen Toggle buttons **2 & 3** to select the desired temperature

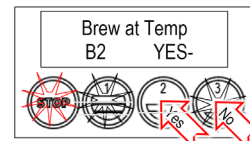

From Tank Temp screen Press button **1** to toggle to the next selection in General Settings or SAVE

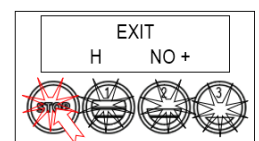

To SAVE and EXIT Press the **STOP** button to the “H” screen. Proceed to screen two below

See the programming menu layout table on the next page to locate the desired control settings to adjust.  
Batch size and menu brewing parameters are in section “A”.



The most common settings for tank temperature setpoint , units of measure are in section “B”.

## Programing Menu Layout

A10 to A70		B10-B40		C10-C50		D10-D90		E10-E70		F10-F120		G1-G15		H10-H11	
Batch Parameters		General Settings		Service Inputs		Service Outputs		Calibration		Service Menu		Counters		Exit and Save	
A11	Brew Volume	B1	Tank Temperature	C1	LLC Probe	D1	Heater SSR	E1	Ready Temp. Offset	F1	Firmware Ver.	G1	Filter Used	H1	Save Changes
A12	Brew Time	B2	Brew at Temp	C2	Basket Sensor	D2	Fill Valve	E2	LLC Sensitivity	F2	Bootloader Ver.	G2	Filter Life	H2	EXIT?
A13	Prewet Percent	B4	Show Tank Temp	C4	Tank Temperature	D4	Brew Valve	E3	Slow Flow Compensate	F3	Select Model	G3	Filter Reset		
A14	Prewet Delay	B5	Units of Temp	C5	USB Drive	D8	Basket Lock	E5	Brew Flow	F5	Option BB Lock	G4	Counter Reset		
A16	Drip Delay	B6	Units of Volume	C6	Keyboard Test	D10	Dilute Valve	E9	Dilute Flow	F8	Backup to USB	G5	Choose Counter		
A20	Batch (2) Enabled	B7	Customer Name			D12	LCD Brightness %	E10	Automatic Calibration	F9	Restore from USB	G10	Brewer Volume [LT]		
A31	Brew Volume	B8	Customers Name			D13	LED Brightness %			F10	Restore Defaults	G11	Brewer Volume [R]		
A32	Brew Time	B9	Demo Mode							F11	Error Log	G14	Rt Brews [LT]		
A33	Prewet Percent	B10	Eco Mode							F12	Erase Error Log	G15	Rt Brews [R]		
A36	Drip Delay	B11	Eco Idle Time							F13	Service Phone#		See Page 10!		
A37	Dilute Mode	B12	Eco Idle Temp							F15	Override Rt BBS				
A37	Dilute Delay	B13	Filter Life							F17	Override Rt BBL				
A37	Dilute Volume														
A39	Batch Temp														
A90	Copy Batch														
A91	Copy Batch: From														
A92	PASTE: To														

### The A menus [A1-3] correspond to batch buttons [1-3] on the touch panel

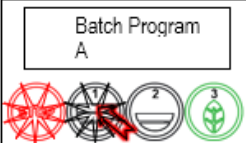
Access the A menus to PROGRAM & make changes to individual menu recipes. Menu settings can be copied  
Menu positions A1 & A3 are permanent. Menu A2 can be removed by operator if desired

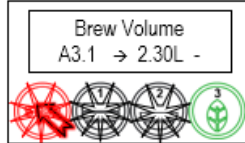
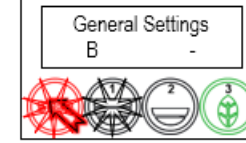
 <p><b>From A PRG screen</b> Press button 1 to go to the A menu access screen</p>	 <p><b>From A11 screen</b> Press <b>STOP</b> to scroll to A20. Batch A20 can be configured to be Tea or Coffee (A1 is permanent)</p>	 <p><b>From A20 screen</b> Press STOP to scroll to the third batch in the "A" menus. Make any changes as required</p>	 <p><b>From A30 screen</b> Press STOP to scroll through COPY and further to remaining programming keys.</p>	 <p><b>To continue</b> Press STOP to scroll through sections See SAVE &amp; EXIT in previous table</p>
--	---	--	---	---

#### RECIPE Location map

View and change settings for the brew recipes from the "A" screens with the controls in PROGRAMMING.

The batch A1 position is permanent and cannot be disabled

To access programming steps A20 and A30

Batch programming steps A20 or A30 will not display from step A10  
Programming for steps A20 and A30 is accessed from any step in A10 by pressing the STOP button (1x for A20;2x for A30).

DISPLAY →

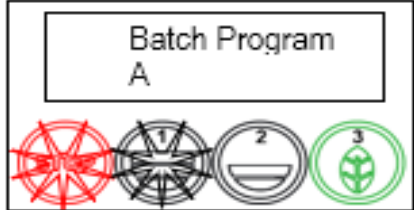

STOP BATCH BATCH BATCH  
A1 A2 A3  
(Coffee) (selectable) (Iced Tea)

**A PROGRAM** **Menu Features: Batch Parameters**

The settings below are shown for the first batch and third buttons on the brewer. Second batch is user optional. See how to access all A menus on the previous page. Below are the brew settings for default A1 & A3 batches

POSITION	Program Items	Factory set Default	Programming Range	Increments	Notes
A11 <b>[Coffee]</b>	Batch Volume	2.20liters 0.58gal	0.95 to 4.0L 0.25 to 1.06 gal	0.05L 0.01G	Unit software is in liters; Can convert to gallon
A12	Brew Time (MIN:SEC)	3:30 minutes	2:00 – 12:00	15 sec	Default total brew time is 5:00 minutes
A13	Prewet Perc.	0%	0.00 – 25.0%	1%	Percentage of total brew volume
A14	Prewet Delay  (Pause after prewet completes)	0% [1:00 Min]	[0:10 – 5:00]	10 sec	The time between prewetting and start of brew cycle. <b>This feature appears ONLY if Prewet &gt;0:00</b>
A16	Drip Delay	1:30 mm:ss	0:30 – 6:00 min.	10 sec	Time brew basket should remain in place during final drip-out →Drip delay remains “ON” for 2:00 minutes if STOP is pressed during brew †
A20 <b>[User Set]</b>	Batch Enabled A20 NO +	NO	OFF/Coffee/or Tea	Select	Batch presets below
A20	Batch Type	Appears only when enabled	OFF/Coffee/Tea	See below	Selectable by user to be an additional batch setting
“COFFEE”	Will set brewer to COFFEE presets as in A10-A20 (above) Middle button will activate and illuminate.				
“TEA”	Will set brewer to TEA presets as in A30-A39 (below) Middle button will activate and illuminate.				
“OFF”	(Factory set default) Middle button will be inactive and will be unlit.				
A30 <b>[Iced Tea]</b>	Batch Enabled A30 YES - NO +	YES (Active)	Middle and Bottom batches A2,A3	Batch on or off	Batches may be individually enabled, rewritten or deactivated
A31	Batch Volume	2.30liters 0.58gal	0.95 to 4.0L 0.25 to 1.06 gal	0.05L 0.01G	Unit software is in liters; converts to gallon
A32	Brew Time	3:00 minutes	2:00 – 12:00	15 sec	Default total brew time is 5:00 minutes
A33	Prewet Percent	0%	0.00 – 25.0%	1%	Percentage of total brew volume
A34	Prewet Delay (see A14 above)	0% [1:00 Min]	[0:10 – 5:00]	10 sec	Time between prewetting and start of brew cycle.
A36	Drip Delay	1:30 mm:ss	0:30 – 6:00 min.	10 sec	→See Note A16
A37	Dilution Mode	Normal	Normal/Fast		NORMAL: Dilution after the brew is completed FAST: Dilution is during the brew cycle
A37	Dilution Delay	0.10	0:00 –12:00 min	10 sec	Pause after brew to begin dilution. Often used to add sweetener
A37	Dilution Volume	9.1 liters 2.4 gallons	0:00 –15:15 liters 0:00 –4:0 gallons	0.05L 0.01G	Unit software is in liters; converts to gallon
A39	Batch Temp	204°F 95.6°C	200°F-207°F 93°-96°C	1°F 1°C	Activates only when brewer is in Tea Brewer mode
A90 <b>Copy Batch</b>					
A91 <b>Copy From</b>	Copy From Batch	1 +	A91 1 (1-6)		Select recipe to copy
A92 <b>(PASTE TO)</b>	Paste To Batch?	1 +	A92.1 (1-6)		Select where to paste

A10 (Left Batch COFFEE) and A30 (Right Batch TEA) cannot be disabled.

A20 middle batch may be set for coffee or tea or disabled.

† DRIP DELAY will not activate when STOP is pressed within 5 seconds of starting a brew time

B GENERAL Brewer Operation Control Settings, Adjust Brew Flow Rate					
POSITION	Program Items	Factory set Default	Programming Range	Increments	Notes
B1	Tank Temp.	200°F-or-93°C NOTE: Units are Celsius by default	170° to 207°F 77° to 97°C	1.0°F 0.5°C	Chart to correct for high altitude below
B2	Brew at Temp.	“YES”	ON/OFF	YES/NO	<b>SEE NOTE BELOW</b>
B3	Batch Temp	OFF	ON/OFF	ON/OFF	For tea brew menu
B4	Show Tank Temperature	YES	YES/NO		To display HW tank temperature on screen
B5	Units of Measure TEMPERATURE	° Fahrenheit	Fahrenheit/Celsius	C/F	<b>NOTE:</b> Overwrites user settings (see page 9)
B6	Units of Measure VOLUME	L LITERS	Liters/Gals/Ounces	L/Gal/Oz	<b>NOTE:</b> Overwrites user settings (see page 9)
B7	Customer Name	Off	NO or YES		For name on screen
B7	Customer Name	(only if above is “ON”)	Scroll with batch keys	A-Z;a-z;0-9	16 characters total
B9	Demo Mode	OFF	DEMO ON/OFF		Demonstrates the controls for training. Disables all components in demo mode
B10	Eco Mode	Off	ON/OFF	YES/NO	If Selected: Lowers hot water tank temperature after preset time of inactivity
B11	Eco Idle Time (turns on if B10 active)	1Hr	1-6 hours	1 hour	Time of inactivity to go into ECO Mode
B12	Eco Idle Temp (turns on if B10 active)	169°F	158-176°F	1 degree	Temperature that hot water tank is lowered to
B13	Filter Life	OFF	ON/OFF	YES/NO	Water filter life is accessed in G-Counters. This is user set and will display indicator to change water filter

BREW AT TEMPERATURE DEFINITIONS

**DEFAULT: BREW AT TEMP: “ON”**

**(FACTORY DEFAULT FOR BREWER)**

“BREW at TEMP:  
-Batch will not start if tank temperature is below set point.  
-Display will show “HEATING” and hot water tank temperature  
The “BREW START” entry buttons will not illuminate until the hot water tank reaches the selected temperature.

**Notifications shown on screen:**  
TEXT: **HEATING**→Tank above 87°C/189°F-will allow brew at low temperature.  
Extracted tea flavor may be affected  
TEXT: **L. HEAT**→Tank above 76°C/169°F-will allow brew at low temperature.  
Tea flavor will be noticeably affected

Hot water tank not at brew temp setpoint.

Tank temp→

STOP is not lit → & BREW START buttons not lit. and **are disabled.**

Batch menu button(s) will illuminate and “READY” will display on screen when hot water tank temperature is at setpoint

**USER SELECTABLE OPTION: BREW AT TEMP: OFF (Not recommended)** Unit will operate at reduced temperature Allows brewing at any temperature above 169°F/76°C

[ft]	[m]	Suggested Setting[°F]	Boiling point[°F]	Suggested Setting[°C]	Boiling point [°C]
0	0	205	212.0	96	100.0
500	152	205	211.0	96	99.5
1000	305	200	210.1	93	98.9
2000	610	200	208.1	93	97.8
2500	762	200	207.2	93	97.3
3000	914	200	206.2	93	96.8
3500	1067	197	205.3	92	96.3
4000	1219	195	204.3	91	95.7
4500	1372	194	203.4	90	95.2
5000	1524	194	202.4	90	94.7
5500	1676	193	201.5	89	94.2
6000	1829	192	200.6	89	93.6
6500	1981	191	199.6	88	93.1
7000	2134	190	198.7	87	92.6
7500	2286	188	197.8	86	92.1
8000	2438	187	196.9	86	91.6
8500	2591	185	196.0	85	91.1

C SERVICE INPUTS		Brewer Sensors and Keypad			
POSITION	Program Items	Factory set Default	Programming Range	Increments	Notes
C1	LLC Probe continuity	Direct read	TDS tank reading (water resistance)	≈850- LOW ≈1600-HIGH	Nominal values
C2	Brew Basket Sensor	Direct read	YES or NO		
C4	Tank Temperature	Direct read	Hot water tank temperature		Actual values
C5	USB Drive	NO			
C6	Keyboard Test	Calibrate	Checks buttons under membrane	YES/NO	Follow directions on the screen

D SERVICE OUTPUTS		Test Valves and Heaters; Set screen brightness			
POSITION	Program Items	Factory set Default	Programming Range	Increments	Notes
D1	Heater SSR Test	Press button 2 to test (button 1 stops test)	Activates heater Default is 10 sec..	Toggle +/- OFF or ON	Energizes Heater(s) <b>WARNING!</b> Service use only.
D2	Fill Valve Test	Press button 2 to test (button 1 stops test)	Activates valve Default is 10 sec.	Toggle +/- OFF or ON	Press To Test
D4	Brew Valve Test	(Press to test)	Activates valve Default is 10 sec.	Toggle +/- OFF or ON	Runs valve to verify flow. NOTE: Have container under brew basket.
D8	Basket Lock	(Press to test)		Toggle +/- OFF or ON	Press To Test
D10	Dilute Valve	(Press to test)		Toggle +/- OFF or ON	Press To Test
Single series displays right side only Left Valve display is only for twin side brewer.					
D12	LCD Brightness	Brightness=90%	20-100%	5%	Adjust LCD screen brightness only-Not for LEDs under buttons
D13	LED Brightness	Brightness=60%	20-100%	5%	Adjust LED button brightness only-Not for the screen display LCD

E CALIBRATION		Brewer Sensors and Keypad			
POSITION	Program Items	Factory set Default	Programming Range	Increments	Notes
E1	Ready Temp. Offset	-3°F -2°C	-2° to -10°F -1° to -5° C	1°F 1°C	Compensates output to measured temperature
E2	LLC Sensitivity	NORMAL ("NORMAL" for most water)	HIGH (Biased for reverse osmosis water or very pure water)	NORMAL HIGH	Liquid level control sensitivity. High, 1300Ω is for reverse osmosis water or very pure water.
E3	Slow flow rate from supply	OFF	OFF/ON	Toggle +/- YES or NO	Trims fill system for low supply or Flojet use
E5	Brew valve flow rate:	1.60L/54oz/0.42G	1.30-1.90Liter 0.34-0.52G	0.05L 0.013G	Adjusts flow rate
E9	Dilute valve flow	2.55L/0.67G	1.75-3.30Liter 0.46-0.86G	0.05L 0.013G	Adjusts flow rate
E10	Automatic Calibration	See grid on page 11			

**Use this formula to compensate for minor discrepancies in actual volume versus programmed volume.**

See "PROGRAM" E5 For valve settings and calibration. Factory set brew valve flow rates are in liter/min

$$\frac{\text{ACTUAL VOLUME}}{\text{PROGRAMMED VOLUME}} \times \text{CURRENT SETTING} = \text{NEW SETTING}$$

**Default Brew Valve Flow Rate—MBS-1221 Brewers**

MBS-1220	Oz/Liter/Gal/minute	Range
Brew Valve FR	54/160/0.42	45oz-64oz
Dilute Valve FR	86oz/2.55L/0.67G	38oz-112oz

Set FR lower to increase volume, set higher to decrease volume.

Use the formula above to determine the correct setting

**NOTE**

Note that the causes below are what usually cause over/under potting. Flow rate is rarely a cause  
Flow rates may need adjustment in equipment more than 3 years old, and are heavily used  
The programmed flowrate of the brewer is usually found to be correct after the typical problems (below) are corrected  
Check for these causes for the difference in the programmed value to the brewed value. Correct these first.

- CSD spray head is not in place. This will always result in an increased flow volume
- Flow related error codes 100, 101 - see page 13. Reduced water flow can cause reduced brew volume.
- Improperly installed inlet valve. See page 17.
- Clogged or fouled brew/dilution valve or inlet valve. Always check for lime scale is over or under filling.
- Lime scale. This can cause erratic and sometimes random under or over brew volumes. Valves can drip, be stuck open or closed, or fail due to lime scale accumulation. Always correct lime scale faults before changing flow rate
- Ensure that the brew volume/time is correct. Verify that volumes and times displayed on the screens are correct.
- Ensure that that the display is showing the brew process as the brewer may not be operating or be shutting off.

Changing the flow rate adjusts the brew volume if it is different from the programmed value.













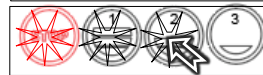



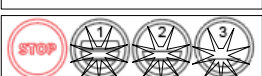

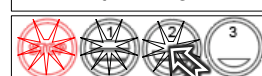

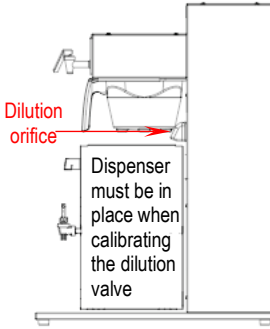
Flow rate of over and under dispensing is corrected in FLOW RATE Calibration Procedure (E10) on the next page.  
The flow rate calibration procedure is an internal program to test for and enter corrections for flow rate inconsistencies.  
In the procedure: the equipment will dispense for 60 seconds. The quantity of brew water dispensed is carefully measured and entered the program. The software automatically corrects the flow rate based on the difference of the actual results to the stored values.

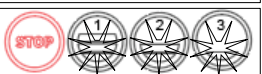
The procedure requires a calibrated 1½ gallon/6liter container. The flow must be very accurately measured. It will be easiest to manage the readings if the brewer volume units are placed into ounces or liters for units of measure. [Go to PROGRAM B6]. Units of measure in gallons require a calculation in fractional units of measure - which can be difficult.

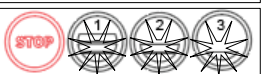
TESTING SHOULD BE MADE WITH AN EMPTY BREW BASKET. NO FILTER PAPER. NO COFFEE OR TEA

## E10 AUTOMATIC CALIBRATION PROCEDURE

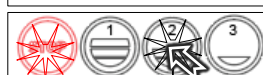
Flow rate calibration is required when the volume dispensed differs significantly and consistently from the brewer setting. This procedure automatically dispenses the selected valve brewer for 60 seconds. Testing should be made with an empty brew basket. No filter paper. No coffee or tea. This procedure tests the brew valve and bypass valves (right side or left side). The quantity dispensed must be very accurately measured. Next: the dispensed quantity is entered into the brewer. The brewer firmware contains algorithms that automatically adjust the valve flow rate to dispense correctly.

<p>Initial default selection will be the Brew Valve.</p> <p>To select the Dilution Valve, go into the Confirm Valve screen and press button #1</p> <p>Note: Right side is default, and the only setting in single side brewers.</p>	<p>Calibration Proc. E10Start NO.</p>  <p>E10 Automatic Opening screen</p> <p>Press button #2 to begin procedure</p>	<p>Calibration E10 Start YES-</p>  <p>Confirm calibration</p> <p>Press button#1 to start</p> <p>Proceed to next screen to confirm valve to test</p>	<p>Calibration Rt Brew V NO.</p>  <p>Confirming valve for brew valve appears next:</p> <p>Select &amp; press button#2 to proceed</p>	<p>Calibration Rt BrewV YES-</p>  <p>Press button#1 to start brew valve calibration next:</p> <p>Button#3 halts procedure</p>
<p>Rt BrewV Place Container</p> 	<p>Calibration Rt BrewV Dispensing 60 sec</p> 	<p>Adjust: Rt BrewV Flow:1.60L+/-</p> 	<p>Adjust: Rt BrewV Flow:1.60L+/-</p> 	<p>Calibration Rt DiV NO.</p> 
<p>Place Iced Tea dispenser under brew head.</p> <p>Insert brew basket.</p> <p>Press button #1 to begin testing</p> <p>*See Heating Note below if it appears</p>	<p>Brewer will dispense for one minute. Screen will show countdown.</p> <p><b>Important Notice:</b> Allow the brew basket to completely drip-out. This may take more than a few minutes</p>	<p>Screen showing setting.</p> <p>Measure the dispensed volume and enter the quantity dispensed by toggling two lower buttons.</p>  <p>RAISES LOWERS</p>	<p>After the volume of the test brew is entered:</p> <p>Press button#1 to calculate .Brewer will automatically complete and install the flow rate corrections.</p>	<p>Confirming valve for dilution valve appears next:</p> <p>Select &amp; press button#2 to proceed</p>
<p>This step calibrates the dilution valve flow rate.</p> <p>Notice that the Dilution Valve dispenses from the dilution orifice on the front of the brewer.</p> <p>Use an iced tea dispenser in position to collect the sample for calibration</p> 	<p>Calibration Rt DiV YES-</p>  <p>Press button#1 to start brew valve calibration</p> <p>Button#3 halts procedure</p>	<p>Rt DiV Place Container</p>  <p>Place iced tea dispenser (best choice) under Dilution Orifice.</p> <p>Press top button to begin testing</p>	<p>Adjust: Rt DiV Flow:2.55L+/-</p>  <p>Screen showing setting.</p> <p>Measure the dispensed volume and enter the quantity dispensed by toggling two lower buttons.</p>  <p>RAISES LOWERS</p>	<p>Adjust: Rt DiV Flow:2.55L+/-</p> 
<p>Adjust: Rt DiV Flow:2.55L+/-</p> 	<p>Calibration Finished</p> 	<p>Calibration Finished</p> 	<p>Calibration Proc. E10Start NO.</p> 	<p>*NOTE! RtBrew V Heating...</p> 
<p>After the volume of the test brew is entered:</p> <p>Press button#1 to calculate .Brewer will automatically complete and install the flow rate corrections.</p>	<p>Press STOP and proceed to screen H.</p> <p><b>IMPORTANT:</b> Save the new settings at screen H - Save &amp; Exit.</p>	<p>Pressing button 1 will return to Automatic Calibration Procedure startup screen.</p>	<p>Returned to Automatic Calibration Procedure startup screen.</p>	<p>NOTE! hot water tank is not at calibration temperature. The process will continue when at correct hot water tank temperature</p>

F SERVICE MENU		Software & Code View and Settings			
POSITION	Program Items	Factory set Default	Programming Range	Increments	Notes
F1	Display Firmware	2.1.210323			Displays current version [4/2021]
F2	Display Bootloader	2.0.210317			Displays current version [4/2021]
F3	Select Model	MBS-1221 Will need reboot	Scroll to brewer model Save & Exit	CBS-1221 CBS-1231, CBS-1232 CBS-1241, CBS-1242 CBS-1251, CBS-1252 CBS-1261, CBS-1262 MBS-1221, MBS-1251 TBS-1221, TBS-1222	<b>NOTE:</b> Overwrites all user settings (See below)
F5	Option BB Lock	NO	NO or YES		Enables brew basket lock
F8	Backup to USB		Follow prompts	Saves settings	Insert blank USB
F9	Restore From USB		Applies settings from USB		Insert USB Will need reboot
F10	Restore Defaults	NO	NO/YES		Reset to factory
F11	Error Log	Lists up to six codes, in order	1: ; 2: ;3:;4: ;5: ;6: 1=Newest/6=Oldest LAST six errors only	Newest=first Oldest=last	See Error Code Chart for references
F12	Erase Error Log	NO +		Toggle +/- YES or NO	FACTORY USE ONLY. DO NOT RESET
F13	Service Phone #				Service
F15	Override Rt BBS	NO	NO/YES	Toggle +/- YES or NO	Disables brew basket sensor
F17	Override Rt BBL	NO	NO/YES	Toggle +/- YES or NO	Disables brew basket lock

**Error Codes** (From SERVICE F11 and F12 – Page11)

DO NOT CLEAR ERROR CODES UNTIL ERROR IS IDENTIFIED AND CORRECTED

→Contact factory or specialized personnel for error codes

Code	Description	Possible Cause	Corrective Action
001	Software error-error on start up or corrupted software	Improper start-up or shutdown	Restart, if still fault: reload software
002	Internal flash corrupted internal data memory malfunction	Error found in cyclic redundancy check <b>CRC</b>	Restart, if still fault: reload software If not corrected: replace board
050	Short-circuit in temperature probe	Probe failure.	Replace probe.
051	Open temperature probe.	Bad probe connection, or probe failure.	Check all connections. Replace probe if necessary.
100	Initial Fill Error. Initial fill time took longer than expected after powering up.	Water supply flow rate is too low, fill valve is stuck, water line kinked or closed.	Reboot machine. If persists-investigate cause of low flow rate. (Clogged water filter, kinked line, stuck fill valve)
101	Error on refill. Tank did not refill within expected time.	Water supply flow rate to hot water tank is too low, or fill valve stuck or damaged <b>(SEE PAGE 17)</b>	Check water supply line. Flow should be 20-75 psig, (138-517kPa) >1gal/3.8L/min Investigate cause of low flow rate. If the flow rate is in range-replace fill valve
200	Heating flatline-Tank is boiling	Heater is on, temperature is not rising/dropping	High elevation correction. Bad heaters or temperature probe or position
201	If the hot water tank heaters are turned on during a heating cycle and tank temperature is not increasing according to software logic and the tank temperature is below setpoint	1) Failure of SSR, high limit, temperature probe, or heating element.  2) Water being removed by hot water faucet during heating (control displays "heating")	1)Test and check SSRs, high limit devices temperature probe. Check heating elements with current clamp, replace if necessary.  2)Advise staff to refrain from taking large amounts of water from hot water tank, especially during "heating".
202	Heater Shorted or Stuck SSR	Heater is off and heating SSR is stuck "ON"	Check ohms on heater (15-60Ω). SSR may be stuck in ON mode-replace SSR.
255	Keyboard [HID] error (Human Interface Device)	Usually from longer than 10 seconds' contact. Or faulty reassembly after service	Restart, if still fault: reload software. If mechanical: replace module
<p>NO BSKT <b><u>Insert Brew Basket</u></b></p>		 <p>Brew basket must be in place <b>This is a SAFETY FEATURE</b></p>	<p>Insert brew basket into brewer rails to enable brewer</p>

## G COUNTERS Brewer Usage, Water Filter Usage, and Statistics

ROLE: [LT]=Permanent total for lifetime of machine [R]=operator resettable [User]=Input needed from operator

Position	Counter	Program items	Role	Information	Increments	Notes
----------	---------	---------------	------	-------------	------------	-------

G1-G3 are for water filter maintenance. Filter Life readings (G1, G2, G3) must be activated in B13 GENERAL if they are not visible and the equipment has a water filter.

All beverage equipment must use filtered water and filter cartridges must be monitored for quality

G1	A, S, B	Filter Used	[User]	0G	Gallons/Liters	Amount of water passed through external water filter. For filter life
G2	A, S, B	Filter Life	[User]	10,000Liters 2,625Gal	25 gal 100 L	Upload published life of filter
G3	A, S, B	Filter Reset	[User]	NO	Toggle +/- ,Y or N	Reset when replacing external water filter
G4	A, S, B	Counter Reset	[User]	NO	Toggle +/- ,Y or N	Resets all resettable counters to zero
G5	<b>A, S, B</b>	Choose Counter		Factory set to BASIC	Basic= <b>B</b> Advanced= <b>A</b> Statistical= <b>S</b>	Stored brewer component activity.. See <b>column 2, Counters</b> , to identify where counters are located.

G20-G55 component use cycles and volumes handled. Available in ADVANCED counter only (G5)

G20	A	Fill Cycles	[LT]	Hot water tank refill cycles	Count	Cycles of hot water tank refill
G21	A	Fill Cycles	[R]			
G22	A	Fill Volume	[LT]	Total volume of water for all brews	Gallons/Liters	Quantity of water for brews
G23	A	Fill Volume	[R]			
G28	A	Rt Brew Cycles	[LT]	Right brew valve operation on/off	Count	Totalized cycles of valve operation
G29	A	Rt Brew Cycles	[R]			
G30	A	Rt Brew Volume	[LT]	Right brew valve flow through volume	Gallons/Liters	Totalized volume through right valve
G31	A	Rt Brew Volume	[R]			
G44	A	Rt Dilute Cycles	[LT]	Count	Count	Totalized cycles of valve operation
G45	A	Rt Dilute Cycles	[R]			
G46	A	Rt Dilute Volume	[LT]	Dilutes valve flow through volume	Gallons/Liters	Totalized volume through dilute valve
G47	A	Rt Dilute Volume	[R]			
G50	A	Rt BBL Cycles	[LT]	Right brew basket lock operation on/off	Count	Totalized cycles of brew basket lock operation
G51	A	Rt BBL Cycles	[R]			
G52	A	Heater Cycles	[LT]	ON/OFF switching for heating elements	Count	Totalized cycles of heater switching
G53	A	Heater Cycles	[R]			
G54	A	Heater On Time	[LT]	Total ON time for heating element	Hour	Totalized heater ON time in hours
G55	A	Heater On Time	[R]			

G80-G91 See illustration below for batch button positions Available in STATISTICAL counter only (G5)

G80	S	Batch 10 Cycles	[LT]	Menu button selection and activation count	Count	Total brews-left side top button
G81	S	Batch 10 Cycles	[R]			
G82	S	Batch 20 Cycles	[LT]	Menu button selection and activation count	Count	Total brews-left side middle button
G83	S	Batch 20 Cycles	[R]			
G84	S	Batch 30 Cycles	[LT]	Menu button selection and activation count	Count	Total brews-left side bottom button
G85	S	Batch 30 Cycles	[R]			

## H SAVE & EXIT

## Saving changes and exiting PROGRAMMING

The brewer will save changes only from the "H" menu. **DO NOT** reboot brewer or toggle ON/OFF-exit as below.

### TO EXIT PROGRAMMING & HOW TO SAVE CONTROL SETTING CHANGES

HOW TO SAVE CHANGES AND EXIT-*The brewer is in PROGRAMMING mode.*

A convenient way to access the steps is to remember to scroll to EXIT→YES and to SAVE →YES

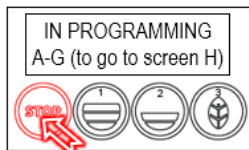

From any screen-  
Press STOP button  
until the EXIT ("G")  
screen appears

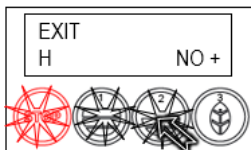

From the "G" screen  
Press button **2** to  
toggle to the EXIT-  
**YES** screen

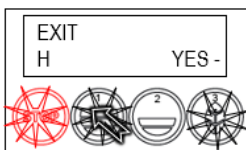

From EXIT screen  
Press button **1** to  
toggle to the SAVE  
screen



From SAVE screen  
Press button **2** to  
toggle to the SAVE-  
**YES** screen

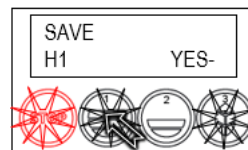

To SAVE and EXIT  
Press button **1** to  
SAVE your changes  
and EXIT to  
OPERATING MODE

**NOTE: User Settings will be erased and overwritten to factory default settings by the following five programming changes**

- 1) When setting or changing units of display for the tank temperature (F Fahrenheit or C Celsius). **(SETTING B5)**
- 2) When setting or changing units of display for the volume (L liters, G gallons). **(SETTING B6)**
- 3) When setting brewer model →The software sets equipment to brewer defaults **(SETTING F3)**
- 4) When loading from USB (Reprograms settings) **(SETTING F9)**
- 5) When restoring defaults (Reloads to defaults ) **(SETTING F10)**

## Operator Training

Review the operating procedures with whoever will be using the brewer.

### Pay particular attention to the following areas:

1. Always pre-heat the dispensers before the first use of each day by filling them halfway with hot water and letting them stand for at least 5 minutes.
2. Do not remove the brew basket from a coffee brewer until it has stopped dripping.
3. Make sure the dispenser is empty before brewing into it.
4. Show how to attach covers, close, and or secure the dispensers for transporting.
5. Show the location and operation of the water shut off valve as well as the circuit breaker for the brewer.
6. Steam from the tank will form condensation in the vent tubes. This condensation will drip into and then out of the brew baskets. Up to 1/4 cup/118cc discharging overnight is possible. Place an appropriate container under each brew basket when not in use.
7. We recommend leaving the power to the brewer on overnight. The water tank is well insulated and very little electricity is used to keep the tank hot. Leaving the brewer in the "ON" position will also avoid delays at the beginning of shifts for the brewer to reach operating temperature.

## Cleaning & Maintenance

### After Each Brew:

1. Dispose of grounds and rinse brew basket.
2. Never strike a brew basket or hit it against a hard surface.  
This will damage the brew cone, and may damage the brew basket support rails
3. Rinse dispensers before reuse.

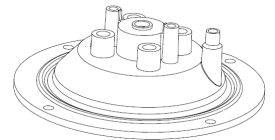

### Every Day:

1. Wash brew basket with hot sudsy water.
2. Pull CSD from the spray head, it is magnetically attached. Use gloves or a heavy towel. → Wash off any film and reattach. Use vinegar if limescale filming is present.
3. Clean dispensers with hot suds water and a brush, rinse and air dry.
4. Use only a soft cloth and hot suds on the outside to avoid scratches. Never use abrasives that will scratch surface.

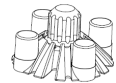

### Weekly

1. Use a commercial coffee dispenser cleaner such as URNEX™, TABZ™, DIP-IT™ or Squeak 'n Clean™.
2. Carefully Follow the instructions supplied with the cleaning product
3. Never use spray cleaners, solvent, solvent based cleaner, or petroleum based polish anywhere on dispensers

### Warning

1. Turn off power before any cleaning procedure, including wiping the exterior for appearance reasons.
2. Dry the exterior, especially the face panel, before turning on power.
3. Do not apply any type of spray cleaner on the face panel of this equipment.
4. Never use solvent or solvent-based cleaner or petroleum based polish anywhere on this equipment.
5. Dry the face of the touch pad before turning on power
6. Do not electrically energize this equipment or attempt operation without all covers in place and all screws fastened.
7. Unplug machine before disassembly or servicing.

### Safety Notes

1. Professional installation is required. This appliance is manufactured only for commercial use
2. Operational requirements and maintenance for commercial cooking appliances differ from household appliances.
3. Operators must be trained for this equipment and must understand the use, maintenance and hazards.
4. Access to the service area is restricted to persons having safety/hygiene knowledge and practical experience of the coffee brewer. This appliance must be installed in locations where it can be overseen by adult trained personnel.
5. Do not attempt to move hot beverage equipment once it is filled. Drain equipment before moving.
6. FETCO commercial coffee brewers prepare large amounts of coffee or tea in a single batch using very hot water
7. Commercial coffee brewers provide very hot water from the spray head, brew basket and faucet when it is pulled.
8. Coffee brewers may continue to dispense very hot water from the mechanically operated faucet after the electronic touchpad is completely disabled by turning off the power switch on the lower back of the unit or unplugging the unit.
9. For safety, the brewer control locks the brew basket for 6.0 minutes after starting the brew.
10. Never attempt to defeat the factory set (default) time that the brew basket is locked for safety from start of brew.

**Keep these instructions for training and future reference.**

## General:

1. If not installed correctly by qualified personnel, the brewer will not operate properly, and damage may result.
2. Utilize only qualified beverage equipment service technicians for service and installation.
3. Always have an empty dispenser under spray head of all brewing equipment-including when at idle
4. Damages resulting from improper installation are not covered by the warranty and will void the warranty.

Below are the key points to consider before installation:

## Electrical:

1. All CBS Series brewers require **an electrical ground wire**. Installation without grounding is dangerous.
2. Note Equipotentiality Terminal, if present, (To identify the terminals which, when connected together, bring the various parts of equipment or of a system to the same potential, not necessarily being the earth (ground) potential, e.g. for local bonding.)
3. Verify voltages, polarity, circuits, and circuit breaker access before attaching equipment.
4. Brewers in this series wire differently in regard to a neutral wire. Review the wire diagrams.
5. The electrical diagram is located in the User's Guide and online at [www.fetco.com](http://www.fetco.com).
6. Make sure of the tight grounding of the equipment and use the external ground bolt.
7. The installation must comply with applicable federal, state, and local codes having jurisdiction at your location. Check with your local inspectors to determine what codes will apply.

→See wiring diagrams for connections

## Plumbing:

1. North America: All installations must comply with applicable federal, state, or local plumbing codes.
2. All Others: The water and waste piping and connections shall comply with the International Plumbing Code, International Code Council (ICC), or to the Uniform Plumbing Code (UPC).
3. Install a backflow prevention device. Most municipalities require a recognized backflow preventer. Usable on all hot beverage and cold beverage equipment is a WATTS® SD-2 or SD-3. WATTS spring loaded double check valve models are accepted by most zoning authorities.  
→The check valve should be as close to the water supply inlet of the beverage equipment as possible
4. All beverage equipment must use a water filter. A finishing carbon filter is preferred
5. Install the filter unit after a water shutoff valve and in a position to facilitate filter replacement.
6. The water line and newly installed filter cartridge must be flushed thoroughly prior to connecting it to the brewer to prevent debris from contaminating the machine
7. Verify that the water line will provide a flow rate of at least 1½gpm/(5.7lpm) per minute and the water pressure is between 20-75 psig (138-517kPa) before making any connections. TBS-1221 / TBS-122Dis factory calibrated to a stable, non-fluctuating water supply pressure at 45 psi
8. Only use the supplied factory dual valve adaptor to attach water supply line to both brewer fittings
9. **See Page 16** The supplied fitting is a 1/4" flare. Other fittings may be substituted for the flare fitting.
10. Hand tighten the factory fitting when connecting the stub on the brewer. This will reduce stress on the internal connections and reduce the possibility of leaks developing after the install has been completed **See Page 16**

## Tank Drain

The water tank must be drained before maintenance procedures, and when the unit is to be relocated or shipped. Drain is for service use only and must not be permanently connected. NOTE: Never plumb a water line to the drain.

1. Disconnect power and water to unit. DANGER: Ensure that all utility connections to the brewer are broken.
2. Move the unit near a sink or obtain a container large enough to hold four gallons of water.  
→Note: The hot water tank holds up to 2¾ gallons/10.1liters.
3. Remove the front panel, tank cover, and allow the tank to cool to a safe temperature
4. The tank drain line and clamp are located inside-under the hot water tank. Pinch the drain line clamp to close
5. Locate the fill valve against the back wall, using pliers, loosen the hose clamp and move it back over the tube.  
→Note Do not loosen the hose clamp to the bottom of the hot water tank
6. Crimp the tube an inch or two away from the drain plug to prevent water from flowing and pull it off the valve.
7. Pull the tube end out of the brewer and position over sink or bucket.
8. Release the crimped tube, hose clamp, and allow the water to flow into the sink or container.
9. Reverse steps 4-8 when service is complete. Ensure pinch clamp is open and hose clamps are in place.

Attach factory supplied Dual Water Inlet Connector Assembly. Install on each valve -Inlet and Dilution  
Check that rubber washer is in adapter. Hand tighten only-and, if necessary, 1/4 turn with wrench

### Part [1102.00488.00](#) Dual Water Inlet Connector Assembly

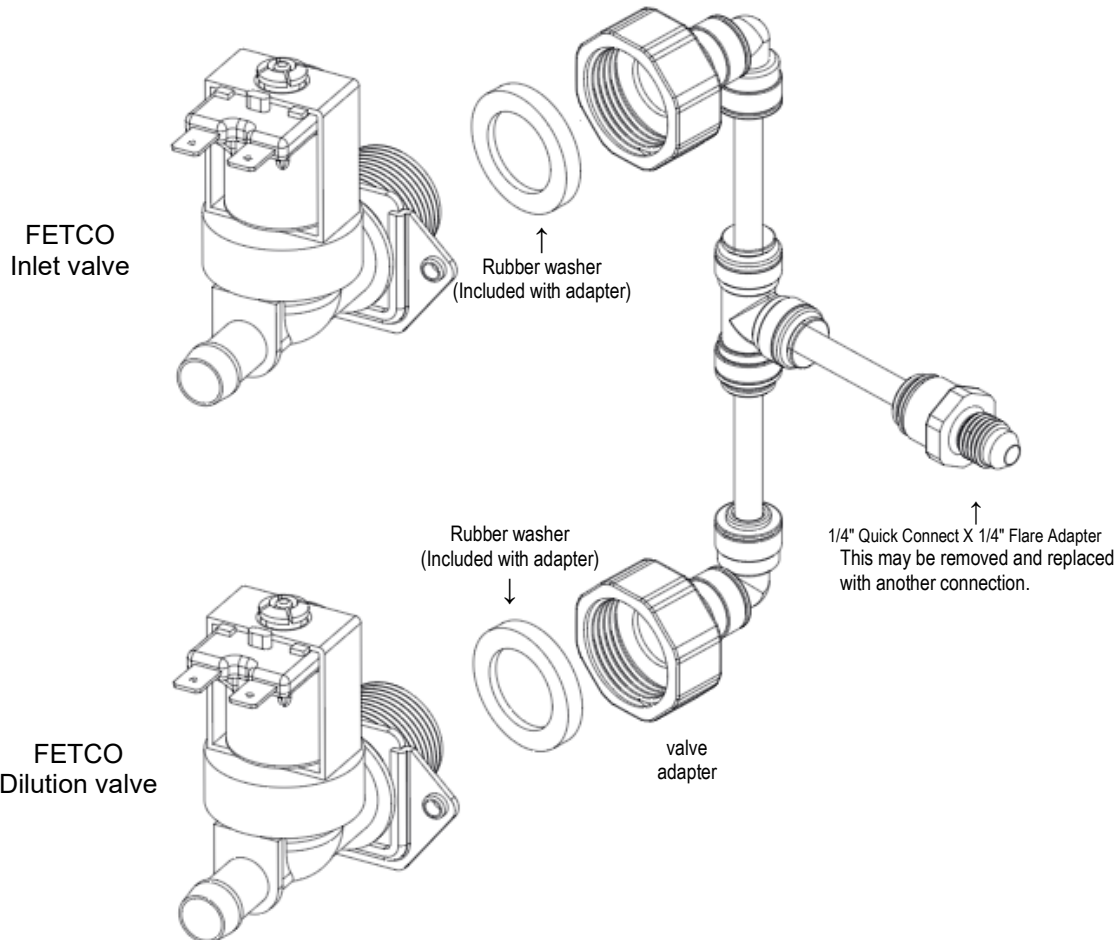

**!WARNING!** Do not substitute any other parts for the dual water inlet connector assembly

Install the adapter on the two valves first before attaching water line. Adapter is included in the carton.  
Use of any other connector to valve will damage the valve  
The valve threads are 3/4" BSP MALE THREAD and are not 3/4 garden hose fittings.  
DO NOT use USA dishwasher water adapter or USA washing machine adapter for this connection.  
The threads on any of these USA adapters are unusable for the valve

**TO PREVENT DAMAGE AND INSURE PROPER EQUIPMENT OPERATION**  
The inlet valve thread is 3/4 INCH BSP (British Standard Pipe).  
This valve is not a standard USA washing machine or dishwasher thread (3/4" GHT)

- Use only the [1102.00488.00](#) plumbing adaptor kit included with this equipment.
- Use the washers included in adaptor kit
- Plumber's tape is not recommended for the adapter to valve connection
- Hand tighten adapter on valve with gasket, then very lightly wrench 1/4 turn to set
- DO NOT SUBSTITUTE FITTINGS FOR CONNECTING TO WATER SUPPLY  
Damage to inlet valve from improper installation will void the warranty

NOTE: DO NOT PLUMB TANK DRAIN. DRAIN IS FOR SERVICE AND MAINTENANCE ONLY.

## Installation safety and hygiene directions-For International and CE equipment

1. Access to the service area is restricted to persons having safety/hygiene knowledge and practical experience of the coffee brewer. This appliance must be installed in locations where it can be overseen by trained personnel.
2. For proper operation, this appliance must be installed indoors where the temperature is between 10°C/50°F to 35°C/95°F. Drain and remove all liquid from equipment and lines if exposed to freezing temperatures.
3. All commercial cooking equipment, including this unit, is not intended for use by children or persons with reduced physical, sensory, or mental capabilities. Ensure proper supervision of children and keep them away from the unit.
4. Children should be supervised to ensure that they do not play hot beverage equipment.
5. This unit must be installed and serviced by qualified personnel only.
6. Installation must conform to all local electrical and plumbing codes. Installation by unqualified personnel will void the unit warranty and may lead to electric shock or burn, as well as damage to unit and/or its surroundings.
7. If the power cord requires repair or replacement-it must be performed by the manufacturer or authorized service personnel with the specified cord only from the manufacturer in order to avoid a hazard.
8. Review the dimensions for the unit and verify that it will fit properly in the space intended for it. Verify that the counter or table will support the total weight of the brewer and dispensers when filled (See: Technical Data).
9. Place the brewer on the counter or stand. When the brewer is in position, level it front to back as well as side-to-side by adjusting the legs.
10. Brewers will need a sturdy supported surface for operation. Do not move brewers when filled.
11. Do not tilt appliance more than 10° to insure safe operation.
12. Unit is for protected indoor use only. Do not steam clean or use excessive water on unit.
13. This unit is not "jet-proof" construction. Do not pressure wash or use jet spray to clean this unit.
14. The unit is not waterproof-do not submerge or saturate with water.

**Equipment exposed to flood and contaminated must not be used due to electrical and food safety.**

**Do not operate if unit has been submerged with water.**

**or saturated with**

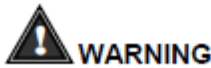

All electrical connections must be in accordance with local electrical codes and any other applicable codes. If the supply cord is damaged, it must be replaced by the manufacturer, its service agent, or similarly qualified persons in order to avoid a hazard.

To prevent an electric shock hazard this device must be bonded to equipment in close proximity with an equipotential bonding conductor. This device is equipped with a bonding lug for this purpose and is marked with the following symbol



	<b>WARNING</b> To reduce risk of electric shock or fire.
	FETCO® Hot Beverage Equipment is for commercial use only.
	Do not remove or open cover. No user serviceable parts inside. Refer installation and service to qualified personnel.
	Caution, disconnect from power supply before servicing.
	GROUND: National Electrical Code requires separate grounding wire.
	Use dedicated circuit with capacity rated by local code or National Electrical Code for the current draw of this equipment. Check serial number plate on right side for power requirements.
	Locate unit away from source of heat. Do not install or use near combustibles.
	<b>THIS APPLIANCE IS ENERGIZED WHENEVER IT IS CONNECTED TO A POWER SOURCE</b>
	<b>FAILURE TO COMPLY RISKS EQUIPMENT DAMAGE, PROPERTY DAMAGE, FIRE, OR SHOCK HAZARD</b>
	This equipment must be installed with a backflow protection device to comply with federal, state or local municipality codes.
	Read the user guide before installing and operating this unit.

Labels and warnings for hot beverage equipment

For BACK PANEL of equipment (1046.00035.00)

### WIRING METHODS: REFERENCE ONLY: SEE WIRING DIAGRAM 1401.00181.00 AT BACK OF THIS GUIDE

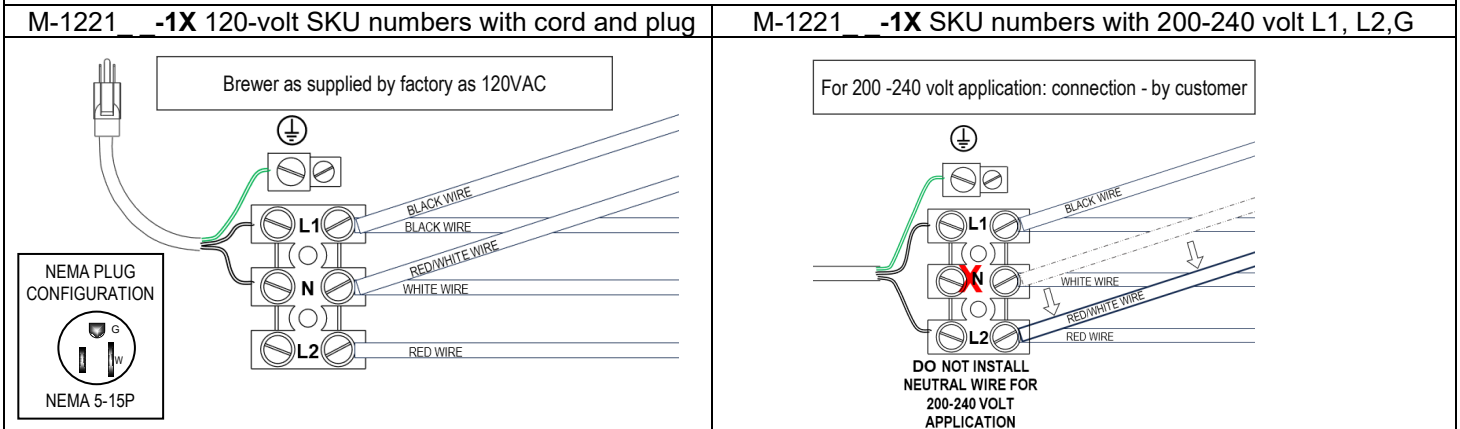

Electrical installation and service is to be made only by licensed electrician. Disconnect equipment from power supply before service. Equipment may be powered even if power switch is "OFF"

# Wiring Diagram

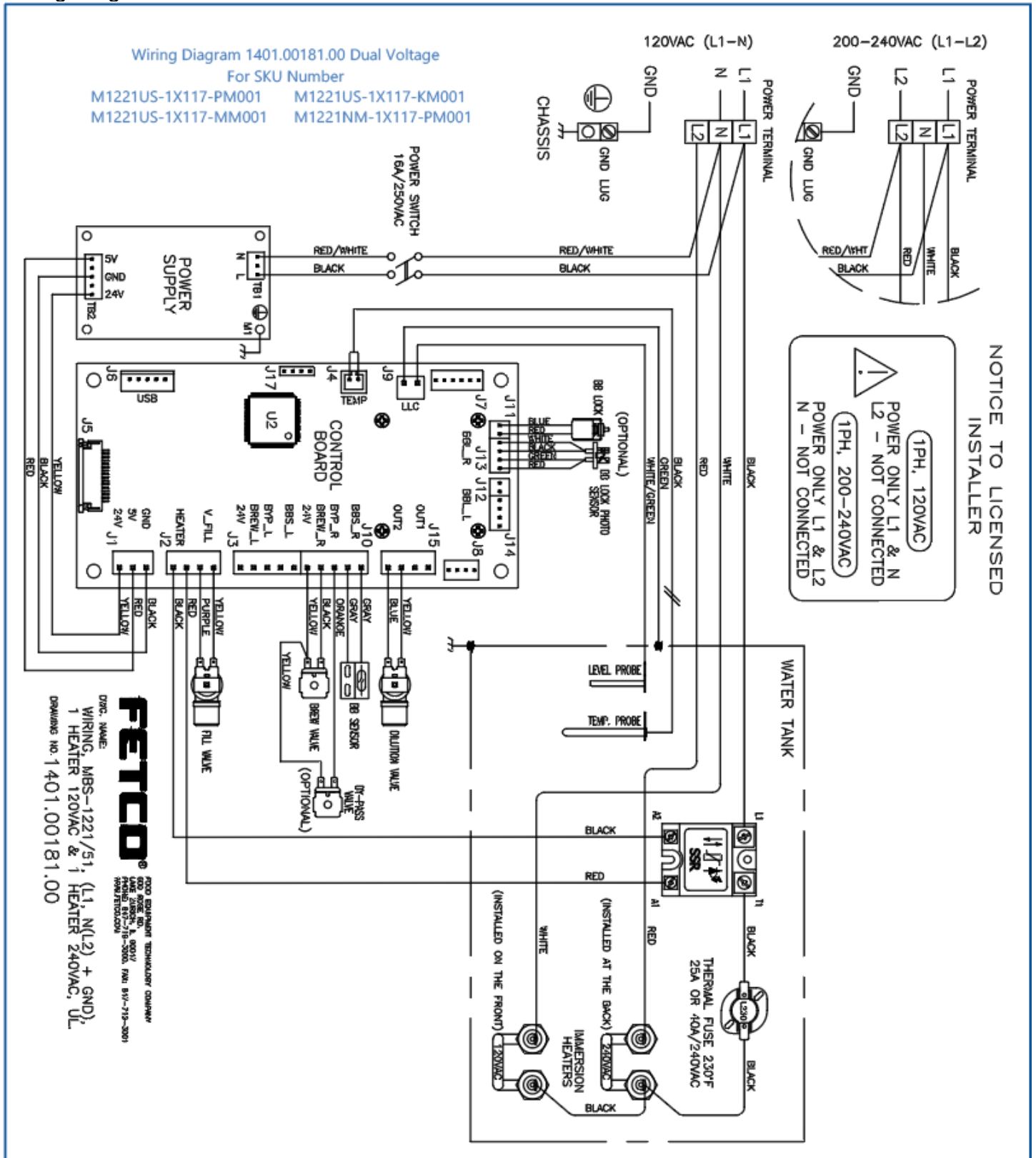

See page 18 for additional wiring information





# Parts Diagrams

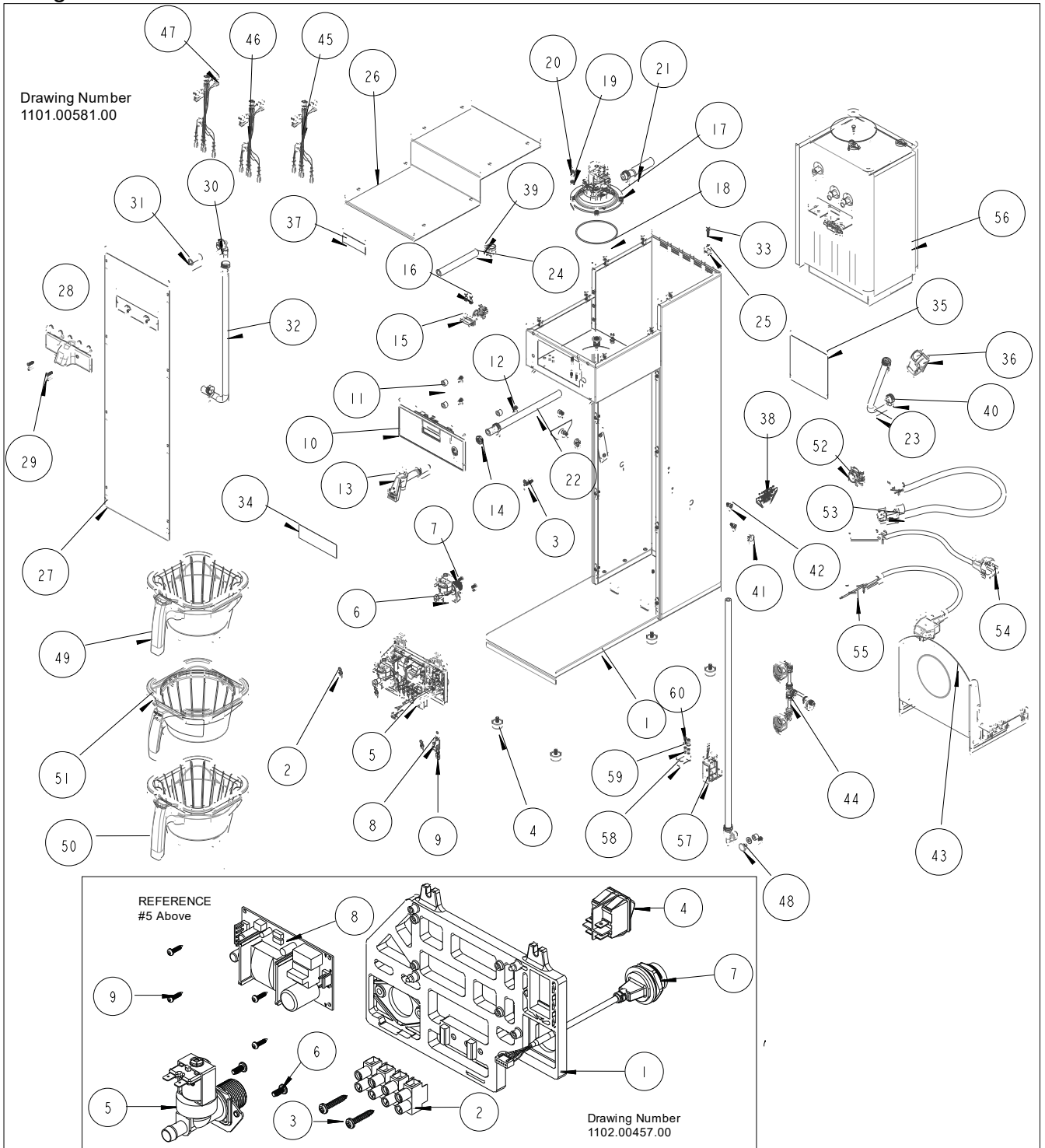

ITEM	Qty	PART NO	DESCRIPTION	MBS-1221 Drawing number 1101.00581.00
1	1	1111.00110.00	WELDMENT BODY, MBS-1221	
2	7	1084.00051.00	NUT, HEX LOCKWASHER, #8-32, 18-8 ST. STL.	
3	1	1082.00082.00	SCREW, PHILLIP HD., 8-32 THREAD	
4	4	1073.00021.00	FOOT, RUBBER, 1/4-20	
5 REF	1	Reference	ELECTRICAL COMPONENT LATTICE, CBS-1200 [P/N 1102.00457.00]	
5-1	1	1023.00360.00	ELECTRICAL MOUNTING LATTICE, AIR POT	
5-2	1	1052.00023.00	EUROSTRIP HE16 TERM. BLOCK, 4 POLE, 63 AMP, 18-8 AWG	
5-3	2	1082.00056.00	SCREW, #8-11 X 1" PAN HD PHIL, THREAD FORMING	
5-4	1	1058.00024.00	SWITCH, POWER, DOUBLE POLE, 16A, 125/250 VAC	
5-5	1	1057.00043.00	SOLENOID VALVE, 5.5L/min, 180 DEG, 24VDC	
5-6	2	1082.00010.00	SCREW, PAN HD. PHIL. MACH., M4x10 ZINC-PLATED	
5-7	1	1058.00055.00	USB CONNECTOR	
5-8	1	1052.00001.00	POWER SUPPLY, 90-264VAC/24VDC, 1.8A	
5-9	4	1082.00132.00	SCREW, PAN HD. PHIL. THREAD-FORMING, #4-20x5/16"LG.	
6	1	1057.00059.00	VALVE, 0.66 GPM BRN FLOW REG, 180DEG/24VDC	
7	2	1082.00010.00	SCREW, PAN HD. PHIL. MACH., M4x10 ZINC-PLATED	
8	1	1065.00009.00	GROUND LUG CONNECTOR, 14-2 AWG, ALUMINUM	
9	1	1044.00012.00	LABEL GROUND, CE	
10	1	1102.00485.00	ASSEMBLY, FRONT PANEL, MBS-1220	
11	3	1023.00361.00	SPACER, UNTHREADED, 1/2"OD X 3/8" LONG	
12	3	1082.00115.00	SCREW, #6 x 3/8" LG., SLOTTED HEX HD. WASHER	
13	1	1071.00055.00	FAUCET, HOT WATER, PSC-BR-8, WITH FLAT AND STEM	
14	1	1084.00048.00	JAM NUT, 1/2-20 UNF, NICKEL PLATED BRASS	
15	1	1102.00113.00	SWITCH, REED, ASSEMBLY	
16	2	1029.00006.00	NUT, FINGER KNURLED, #4-40	
17	1	1102.00203.01	ASSEMBLY, SPRAY HOUSING, DSVP11 DESIGN, NO VENT	
18	1	1024.00063.00	O-RING, 3 15/16" x 3/32" CS, DASH # 154, BUNA-N, DURO-A50	
19	4	1083.00010.00	WASHER, #10 SCREW W/NEOPRENE-BONDED SEAL	
20	4	1084.00006.00	NUT, 8-32 18-8 HEX MACHINE SCREW	
21	1	1024.00065.00	CONNECTOR, SILICONE, TANK TO BREW VALVE	
22	1	1025.00039.00	TUBE, 5/8" OD X 3/8 ID X 10" LG, DRAIN	
23	1	1025.00058.00	TUBE, 9/16"OD X 5/16"ID X 25.00"LG	
24	1	1025.00046.00	TUBE, 5/8" OD X 3/8" ID X 5.0" LG, DOUBLE VALVE	
25	19	1084.00011.00	NUT, CLIP ON (J-NUT), #6-32, 22-20 GA., BLK-PH FINISH	
26	1	1001.00425.00	TOP COVER, CBS-1221	
27	1	1112.00548.00	WELDMENT FRONT COVER, MBS-1221	
28	1	1023.00397.00	FAUCET, DILUTION, SINGLE, BLACK	
29	2	1082.00058.00	SCREW, # 8-32 X 5/8, FLAT HD, PH, 18-8 SS	
30	1	1023.00183.00	FITTING, ELBOW, GROMMET, .375"	
31	1	1025.00022.00	TUBE, 5/8"OD X 3/8"ID X 1.25LG., BY-PASS	
32	1	1025.00068.00	TUBE, 9/16"OD X 5/16"ID X 21.75"LG	
33	16	1082.00017.00	SCREW, TRUSS HD. PHIL. MACHINE, # 6-32 X 1/2 LG.	
34	1	1046.00003.00	LABEL, CSD WARNING, 1.5" X 5.0"	
35	1	1046.00035.00	LABEL, WARNING "TO REDUCE RISK OF ELECTRIC SHOCK OR FIRE"	
36	1	1086.00009.00	CLAMP, 3/4" MAX TUBE OD FLOW CONTROL	
37	1	1041.00033.00	BLACK EXTRACTOR PLUS LABEL, LASER ENGRAVED	
38	2	1046.00006.00	LABEL, WARNING, "HOT WATER FAUCET"	
39	1	1086.00002.00	CLAMP, HOSE, SIZE "G" NYLON	
40	6	1086.00003.00	UNICLAMP, 15.9 HOSE OD CLAMP	
41	2	1086.00047.00	CAP PLUG, PANEL, 15/32 ID x 5/8 OD, TBS-2111	
42	4	1082.00134.00	SHOULDER SCREW, LOCKING, #10-32 X 1/4"	
43	1	1001.00451.00	SHELF, UNIVERSAL, MBS-1221	
44	1	1102.00488.00	ASSEMBLY, DUAL WATER INLET CONNECTOR	
45	1	1402.00113.00	WIRE HARNESS ADDITION, POWER SUPPLY GROUND	
46	1	1402.00118.00	WIRE HARNESS, MBS-1221, HIGH AMP	
47	1	1402.00119.00	WIRE HARNESS, MBS-1221, LOW AMP	
48	1	1000.00140.00	KIT, HOT WATER FAUCET OPTION, MBS	
49	1	B014218BN2BK	BREW BASKET ASSY, BLACK, 13" X 5", 0.218" DIA HOLE, BROWN PLUG	
50	1	B014140G2BK	BREW BASKET ASSY, BLACK, 13" X 5", 0.140" DIA HOLE, GREEN PLUG	
51	1	B003218B1	BREW BASKET ASSY, 13" X 5", .218 DIA HOLE, BLACK HANDLE	
52	1	1086.00008.00	CONNECTOR, CLAMP, NON-METALLIC CABLE, 3/4"	
53	1	1063.00016.00	POWER CORD, 120VAC W/NEMA 5-15P PLUG (N. America-Mexico)	
54	1	1063.00030.00	CORD PWR, 16A/250VAC, EU1-16P PLUG, W/O CONNECTORS, CE	
55	1	1063.00034.00	CORD, POWER, 13A 250VAC, 2.5M LG., UK	
56	1	1104.00190.00	TANK ASSEMBLY, CBS/MBS-1221, 1.7kW/120VAC OR 3.2kW/240VAC	
57	1	1102.00219.00	ASSEMBLY, BB LOCKER, 24VDC	
58	1	1003.00259.00	BRACKET, BREW BASKET LOCK COVER	
59	2	1083.00011.00	WASHER, #8 SCREW SIZE, INTERNAL TOOTH LOCK	
60	2	1084.00010.00	NUT, HEX, #6-32, UNDERSIZED, ZINC PLATED	

Drawing  
1101.00589.00  
MBS-1221 Short

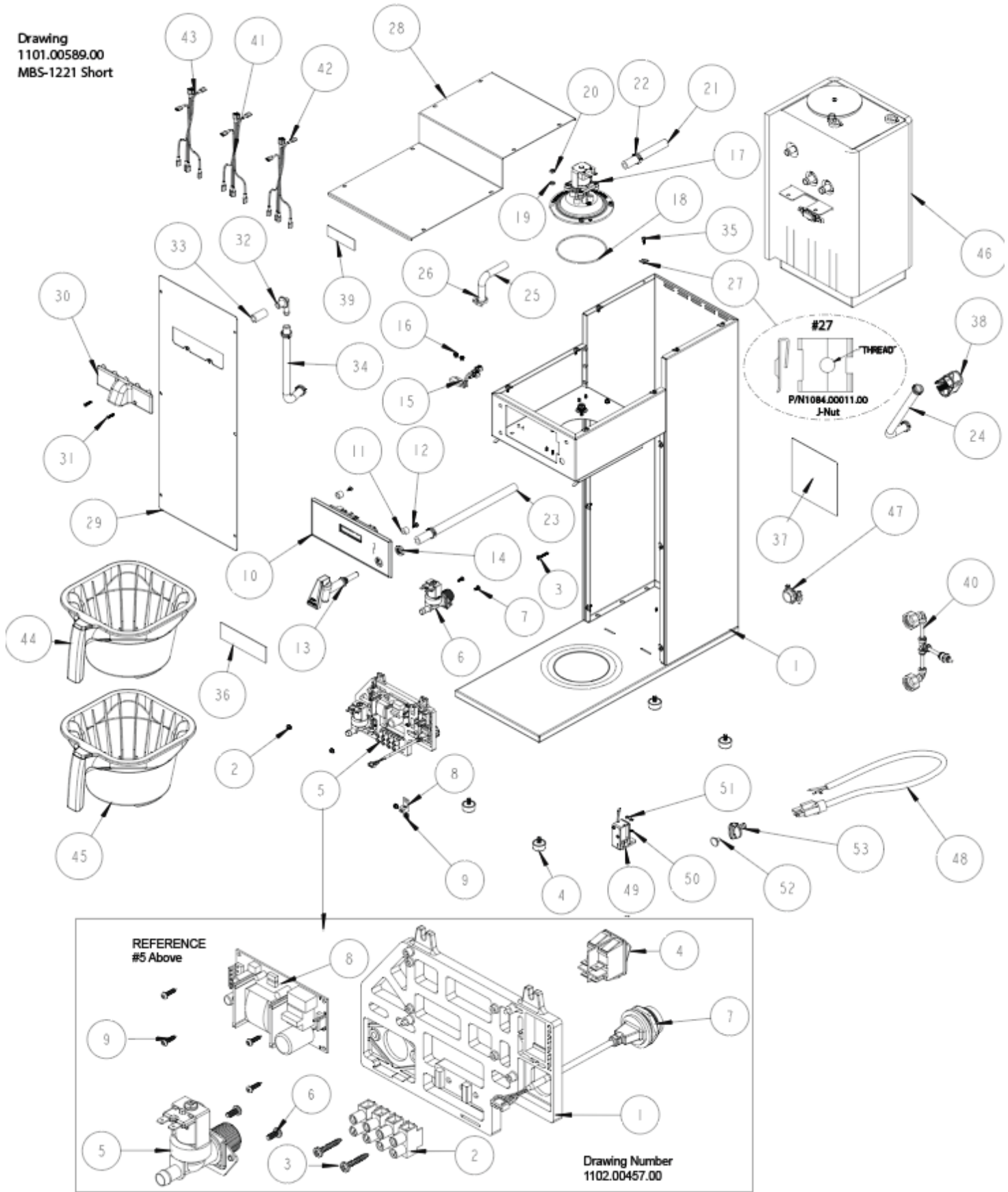

ITEM	Qty	PART NO	DESCRIPTION Drawing number 1101.00589.00 MBS-122S SHORT ONLY
1	1	<a href="#">1111.00113.00</a>	WELDMENT BODY, MBS-122S, SHORT
2	7	<a href="#">1084.00051.00</a>	NUT, HEX LOCKWASHER, #8-32, 18-8 ST. STL.
3	1	<a href="#">1082.00082.00</a>	SCREW, PHILLIP HD., 8-32 THREAD
4	4	<a href="#">1073.00021.00</a>	FOOT, RUBBER, 1/4-20
5REF	1	Reference	ELECTRICAL COMPONENT LATTICE, CBS-1200
5-1	1	<a href="#">1023.00360.00</a>	ELECTRICAL MOUNTING LATTICE, AIR POT
5-2	1	<a href="#">1052.00023.00</a>	EUROSTRIP HE16 TERM. BLOCK, 4 POLE, 63 AMP, 18-8 AWG
5-3	2	<a href="#">1082.00056.00</a>	SCREW, #8-11 X 1" PAN HD PHIL, THREAD FORMING
5-4	1	<a href="#">1058.00024.00</a>	SWITCH, POWER, DOUBLE POLE, 16A, 125/250 VAC
5-5	1	<a href="#">1057.00043.00</a>	SOLENOID VALVE, 5.5L/min, 180 DEG, 24VDC
5-6	2	<a href="#">1082.00010.00</a>	SCREW, PAN HD. PHIL. MACH., M4x10 ZINC-PLATED
5-7	1	<a href="#">1058.00055.00</a>	USB CONNECTOR
5-8	1	<a href="#">1052.00001.00</a>	POWER SUPPLY, 90-264VAC/24VDC, 1.8A
6	1	<a href="#">1057.00080.00</a>	FILL VALVE, SINGLE, 180 DEG, 24VDC, (2.1-2.5L/min INLET FLOW)
7	2	<a href="#">1082.00010.00</a>	SCREW, PAN HD. PHIL. MACH., M4x10 ZINC-PLATED
8	1	<a href="#">1065.00009.00</a>	GROUND LUG CONNECTOR, 14-2 AWG, ALUMINUM
9	1	<a href="#">1044.00012.00</a>	LABEL GROUND, CE
10	1	<a href="#">1102.00485.00</a>	ASSEMBLY, FRONT PANEL, MBS-1220
11	3	<a href="#">1023.00361.00</a>	SPACER, UNTHREADED, 1/2"OD X 3/8" LONG
12	3	<a href="#">1082.00115.00</a>	SCREW, #6 x 3/8" LG., SLOTTED HEX HD. WASHER
13	1	<a href="#">1071.00055.00</a>	FAUCET, HOT WATER, PSC-BR-8, WITH FLAT AND STEM
14	1	<a href="#">1084.00048.00</a>	JAM NUT, 1/2-20 UNF, NICKEL PLATED BRASS
15	1	<a href="#">1102.00113.00</a>	SWITCH, REED, ASSEMBLY
16	2	<a href="#">1029.00006.00</a>	NUT, FINGER KNURLED, #4-40
17	1	<a href="#">1102.00203.01</a>	ASSEMBLY, SPRAY HOUSING, DSVP11 DESIGN, NO VENT
18	1	<a href="#">1024.00063.00</a>	O-RING, 3 15/16" x 3/32" CS, DASH # 154, BUNA-N, DURO-A50
19	4	<a href="#">1083.00010.00</a>	WASHER, #10 SCREW W/NEOPRENE-BONDED SEAL
20	4	<a href="#">1084.00006.00</a>	NUT, 8-32 18-8 HEX MACHINE SCREW
21	1	<a href="#">1025.00013.00</a>	TUBE, 5/8"OD X 3/8"ID X 4.5"LG
22	6	<a href="#">1086.00003.00</a>	UNICLAMP, 15.9 HOSE OD CLAMP
23	1	<a href="#">1025.00110.00</a>	TUBE DRAIN, 5/8"OD X 3/8"ID X 10" LG.
24	1	<a href="#">1025.00058.00</a>	TUBE, 9/16"OD X 5/16"ID X 25.00"LG
25	1	<a href="#">1025.00061.00</a>	TUBE, 9/16"OD X 5/16"ID X 2.75"LG
26	1	<a href="#">1086.00002.00</a>	CLAMP, HOSE, SIZE "G" NYLON
27	14	<a href="#">1084.00011.00</a>	NUT, CLIP ON (J-NUT), #6-32, 22-20 GA., BLK-PH FINISH
28	1	<a href="#">1001.00455.00</a>	TOP COVER, MBS/TBS-1200, LARGE
29	1	<a href="#">1112.00550.00</a>	WELDMENT FRONT COVER, MBS-122S, SHORT
30	1	<a href="#">1023.00397.00</a>	FAUCET, DILUTION, SINGLE, BLACK
31	2	<a href="#">1082.00058.00</a>	SCREW, # 8-32 X 5/8, FLAT HD, PH, 18-8 SS
32	1	<a href="#">1023.00183.00</a>	FITTING, ELBOW, GROMMET, .375"
33	1	<a href="#">1025.00022.00</a>	TUBE, 5/8"OD X 3/8"ID X 1.25LG., BY-PASS
34	1	<a href="#">1025.00071.00</a>	TUBE, 9/16"OD x 5/16"ID x 16.75"LG.
35	14	<a href="#">1082.00017.00</a>	SCREW, TRUSS HD. PHIL. MACHINE, # 6-32 X 1/2 LG.
36	1	<a href="#">1046.00003.00</a>	LABEL, CSD WARNING, 1.5" X 5.0"
37	1	<a href="#">1046.00035.00</a>	LABEL, WARNING "TO REDUCE RISK OF ELECTRIC SHOCK OR FIRE"
38	1	<a href="#">1086.00009.00</a>	CLAMP, 3/4" MAX TUBE OD FLOW CONTROL
39	1	<a href="#">1041.00033.00</a>	BLACK EXTRACTOR PLUS LABEL, LASER ENGRAVED
40	1	<a href="#">1102.00488.00</a>	ASSEMBLY, DUAL WATER INLET CONNECTOR
41	1	<a href="#">1402.00113.00</a>	WIRE HARNESS ADDITION, POWER SUPPLY GROUND
42	1	<a href="#">1402.00118.00</a>	WIRE HARNESS, MBS-1221, HIGH AMP
43	1	<a href="#">1402.00119.00</a>	WIRE HARNESS, MBS-1221, LOW AMP
44	1	<a href="#">B015280BN2BK</a>	BREW BASKET ASSY BLACK, 16" X 6", 0.280" DIA HOLE, BROWN PLUG
45	1	<a href="#">B015140G2BK</a>	BREW BASKET ASSY BLACK, 16" X 6", 0.140" DIA HOLE, GREEN PLUG
46	1	<a href="#">1104.00190.00</a>	TANK ASSEMBLY, CBS/MBS-1221, 1.7kW/120VAC OR 3.0KW/240VAC
47	1	<a href="#">1086.00008.00</a>	CONNECTOR, CLAMP, NON-METALLIC CABLE, 3/4"
48	1	<a href="#">1063.00016.00</a>	POWER CORD, 120VAC W/NEMA 5-15P PLUG
49	1	<a href="#">1102.00219.00</a>	ASSEMBLY, BB LOCKER, 24VDC
50	2	<a href="#">1083.00011.00</a>	WASHER, #8 SCREW SIZE, INTERNAL TOOTH LOCK
51	2	<a href="#">1084.00010.00</a>	NUT, HEX, #6-32, UNDERSIZED, ZINC PLATED
52	1	<a href="#">1023.00399.00</a>	HOT WATER PLUG & CONNECTOR
53	1	<a href="#">1023.00147.00</a>	PLUG, TANK SERVICE DRAIN FOR 18 GA AND UP BODY

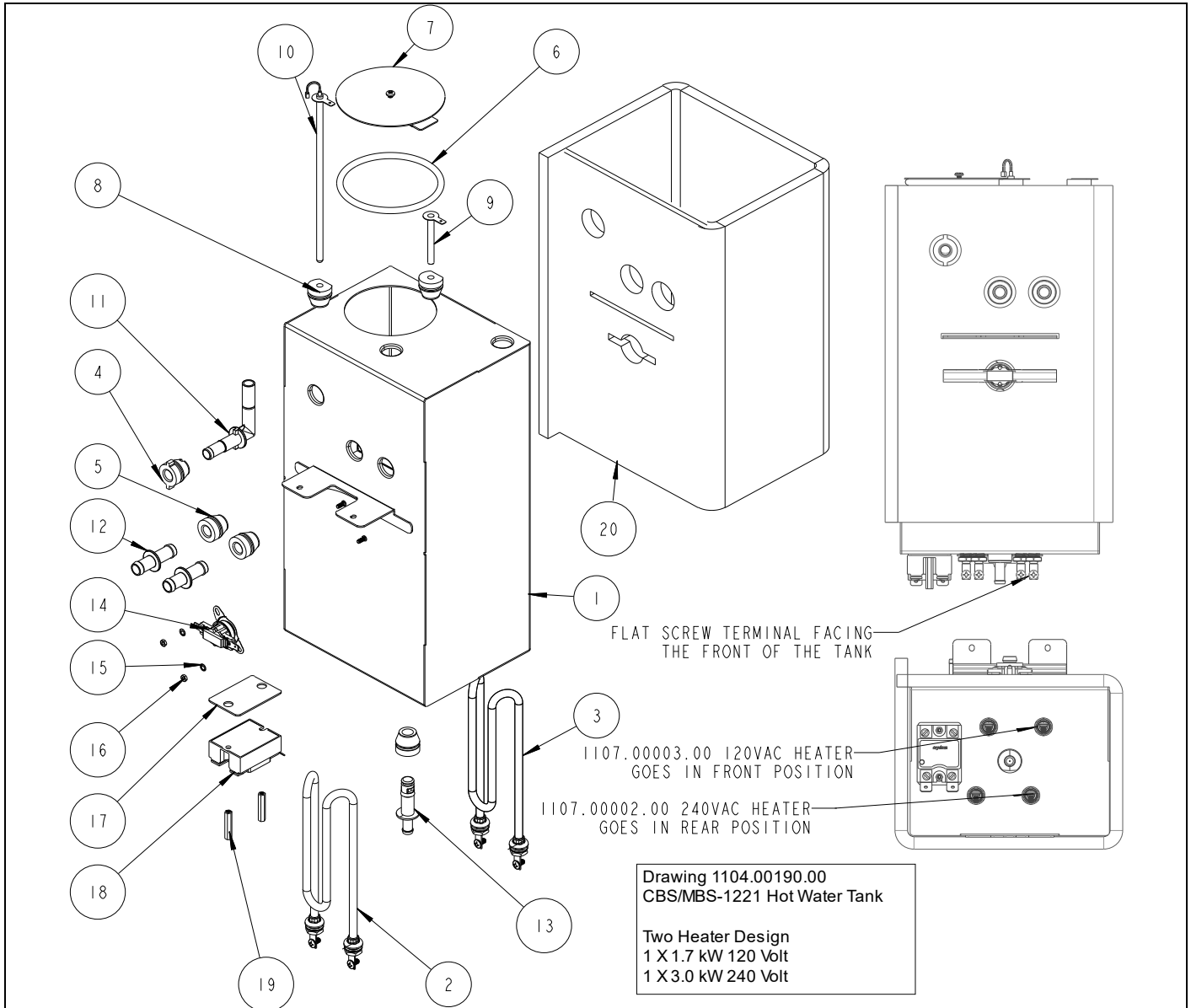

ITEM	Qty	PART NO	DESCRIPTION
Hot Water Tank CBS-1221 Drawing number 1104.00190.00			
1	1	1114.00167.00	WELDMENT, TANK, CBS-1221, 2 HEATERS
2	1	1107.00003.00	HEATER ASSY, IMMERSION 1700W/120VAC
3	1	1107.00002.00	HEATER ASSY, IMMERSION 3000W/240VAC
4	1	1024.00111.00	GROMMET, SILICONE, W/ POSITION TABS
5	3	1024.00050.00	GROMMET, SILICONE, 11.4mm ID
6	1	1024.00007.00	O-RING, DASH #344, TANK COVER
7	1	1102.00207.00	TANK COVER ASSEMBLY, TBS-2121
8	3	1024.00062.00	GROMMET, SHORT, SILICONE, LEVEL AND TEMP PROBE
9	1	1112.00002.00	PROBE WELDMENT, WATER LEVEL 2.25" LG
10	1	1102.00161.00	PROBE ASSEMBLY, TEMP. AND LLC, 8" LONG
11	1	1023.00362.00	FITTING VENT, ELBOW, .375" X .375", SELF POSITIONING
12	2	1023.00167.00	FITTING, STRAIGHT, GROMMET, .500"
13	1	1023.00166.00	FITTING, COLD WATER INLET, GROMMET DESIGN
14	1	1053.00051.00	THERMOSTAT, SINGLE SHOT, 240V/25A
15	2	1083.00009.00	WASHER, #6 SCREW, INTL TOOTH LOCKWASHER
16	2	1084.00010.00	NUT, HEX, #6-32, UNDERSIZED, ZINC PLATED
17	1	1003.00140.00	ALUMINUM BRACKET FOR SSR
18	1	1052.00033.00	RELAY, SOLID STATE, 50A/480VAC, W/BUILD IN VARISTOR
19	2	1081.00042.00	STANDOFF, 1/4" HEX
20	1	1022.00112.00	TANK INSULATION, CBS-1221

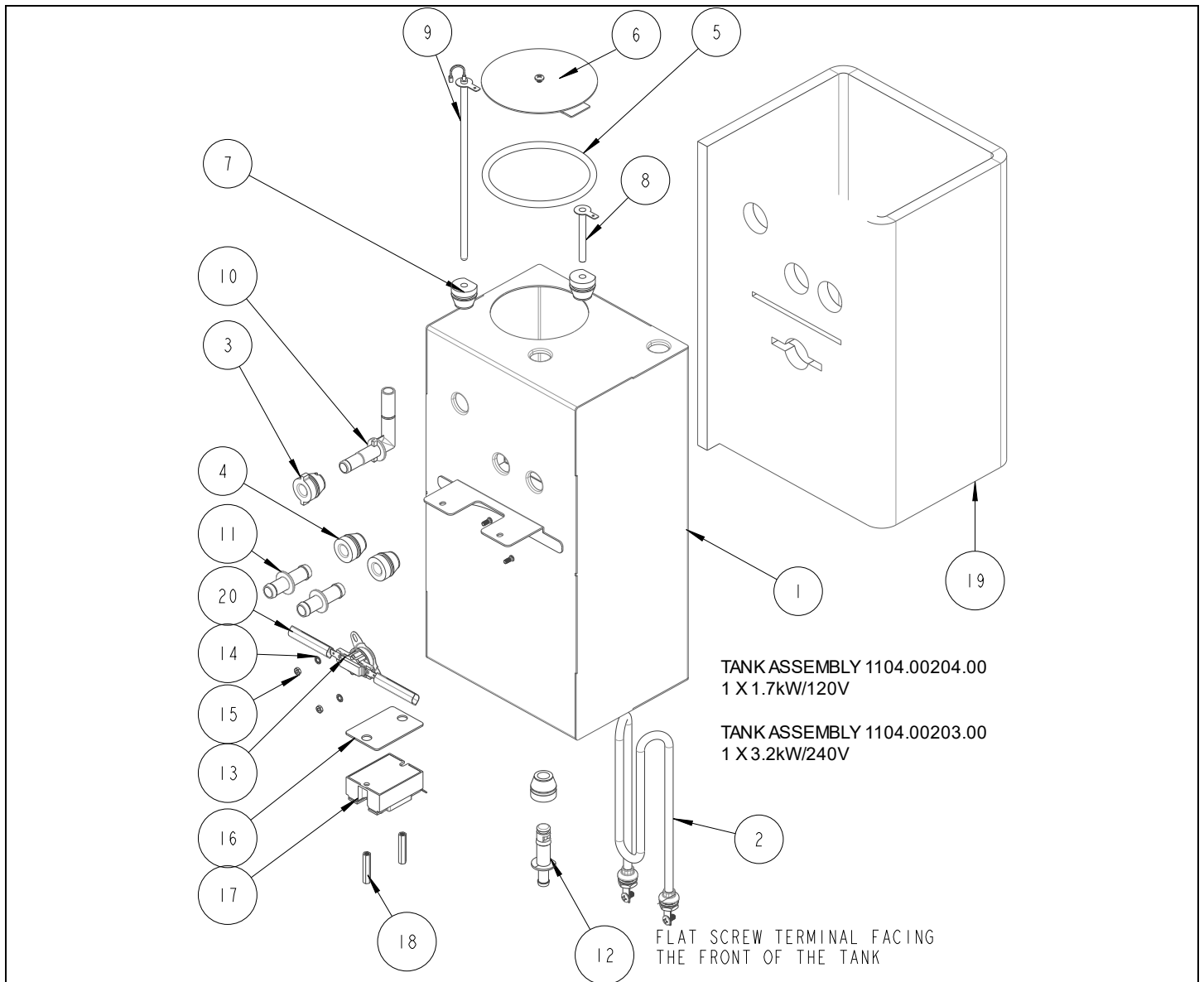

ITEM	Qty	PART NO	DESCRIPTION
Hot water tank drawing numbers 1104.00203.00 & 1104.00204.00			
1	1	1114.00173.00	WELDMENT, TANK, CBS/MBS-1221, ONE HEATER
2	1	1107.00002.00	HEATER ASSY, IMMERSION 3000W/240VAC (1104.00203.00)
2	1	1107.00003.00	HEATER ASSY, IMMERSION 1700W/120VAC (1103.00304.00)
3	1	1024.00111.00	GROMMET, SILICONE, W/ POSITION TABS
4	3	1024.00050.00	GROMMET, SILICONE, 11.4mm ID
5	1	1024.00007.00	O-RING, DASH #344, TANK COVER
6	1	1102.00207.00	TANK COVER ASSEMBLY, TBS-2121
7	2	1024.00062.00	GROMMET, SHORT, SILICONE, LEVEL AND TEMP PROBE
8	1	1112.00002.00	PROBE WELDMENT, WATER LEVEL 2.25" LG
9	1	1102.00161.00	PROBE ASSEMBLY, TEMP. AND LLC, 8" LONG
10	1	1023.00362.00	FITTING VENT, ELBOW, .375" X .375", SELF POSITIONING
11	2	1023.00167.00	FITTING, STRAIGHT, GROMMET, .500"
12	1	1023.00166.00	FITTING, COLD WATER INLET, GROMMET DESIGN
13	1	1053.00051.00	THERMOSTAT, SINGLE SHOT, 240V/25A
14	2	1083.00009.00	WASHER, #6 SCREW, INTL TOOTH LOCKWASHER
15	2	1084.00010.00	NUT, HEX, #6-32, UNDERSIZED, ZINC PLATED
16	1	1003.00140.00	ALUMINUM BRACKET FOR SSR
17	1	1052.00033.00	RELAY, SOLID STATE, 50A/480VAC, W/BUILD IN VARISTOR
18	2	1081.00042.00	STANDOFF, 1/4" HEX
19	1	1022.00112.00	TANK INSULATION, CBS-1221
20	2	1022.00032.00	SLEEVE, Ø.50 x 2.0" LG. x 1.50" SLOT

**1102.00203.01**

FETCO 24 volt small spray dome is found on some models of CBS-1200, MBS-1200, TBS-1200

Before July 2023

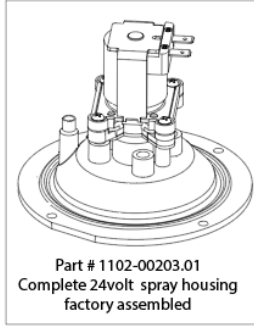

Part # 1102-00203.01  
Complete 24volt spray housing factory assembled

**Spray Housing Assembly Parts**

Small spray dome parts breakdown

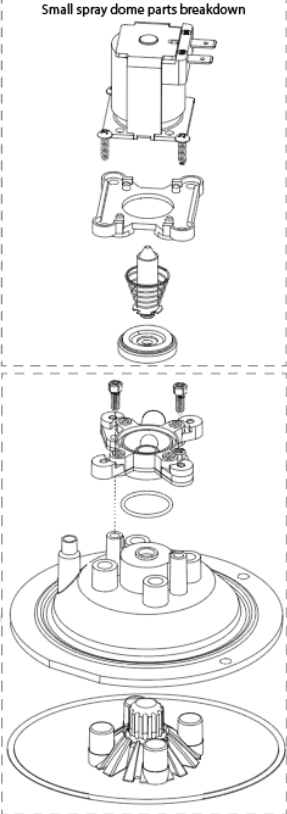

**MBS-1221/MBS-1222**

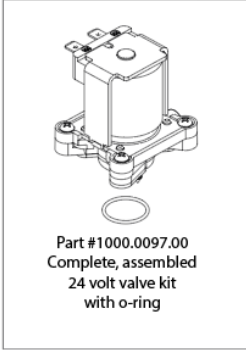

Part #1000.0097.00  
Complete, assembled 24 volt valve kit with o-ring

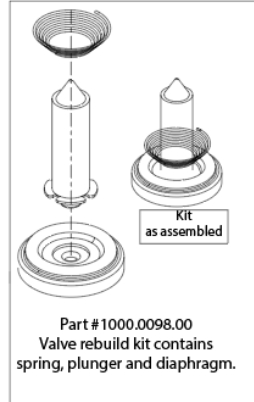

Part #1000.0098.00  
Valve rebuild kit contains spring, plunger and diaphragm.

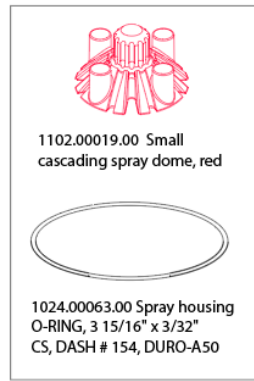

1102.00019.00 Small cascading spray dome, red



1024.00063.00 Spray housing O-RING, 3 15/16" x 3/32" CS, DASH # 154, DURO-A50

Small Spray Assembly Parts List-After July 2023 (Check your equipment to determine your type)

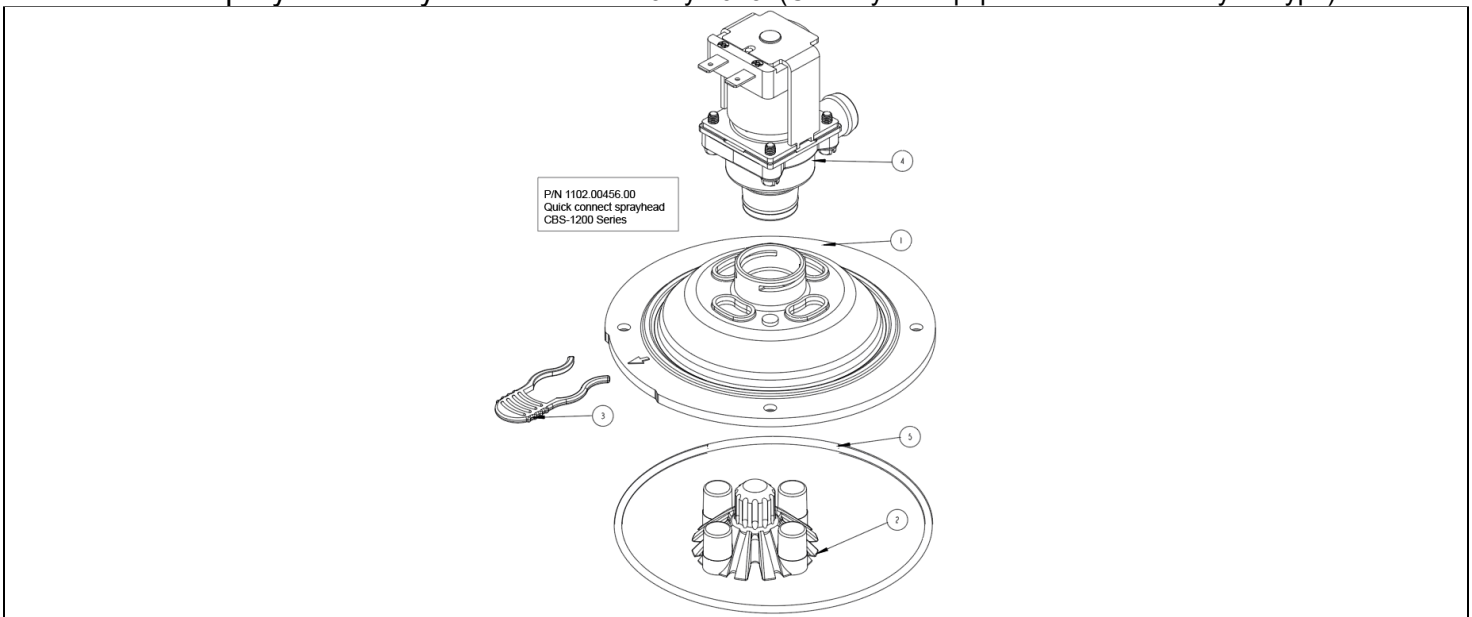

ITEM	Qty	PART NO	DESCRIPTION	Drawing number 1101.00569.00
1	1	1000.00142.00	BASE, QUICK CONNECT SPRAY HEAD, RETROFIT	
2	1	<a href="#">1102.00479.00</a>	ASSEMBLY, CASCADE SPRAY DOME, NEXT GEN, ORANGE	
3	1	1023.00342.00	QUICK CONNECT CLIP	
4	1	<a href="#">1057.00076.00</a>	VALVE ASSEMBLY, COMPLETE, NG, DELTROL(interchangeable with <a href="#">1057.00078.00</a> )	
4	1	<a href="#">1057.00078.00</a>	VALVE ASSEMBLY, COMPLETE, NG, RPE (interchangeable with <a href="#">1057.00076.00</a> )	
5	1	<a href="#">1024.00063.00</a>	O-RING, 3 15/16" x 3/32" CS, DASH # 154, BUNA-N, DURO-A50	
NS	4	<a href="#">1083.00010.00</a>	WASHER, #10 SCREW W/NEOPRENE-BONDED SEAL	
NS	4	<a href="#">1084.00006.00</a>	NUT, 8-32 18-8 HEX MACHINE SCREW	

## Brew Basket Parts

	Complete 13"X5" Stainless Steel Brew Basket - Coffee <a href="#">B003218B1</a>		
	#	Part #	Description
	1	<a href="#">1112.00128.00</a>	BB WLDMNT, 13"X5", W/ Ø5.5MM (.218) HOLE
	2	<a href="#">1009.00006.00</a>	BASKET, WIRE, 13" X 5", CBS-2040'S
	3	<a href="#">1082.00040.00</a>	SCREW, FLT HD. PHIL. W/NYLON 1/4-20 X .50
	4	<a href="#">1046.00025.00</a>	LABEL, BREW BASKET WARNING, GRAY
	5	<a href="#">1102.00064.00</a>	HANDLE W/MAGNET, BLACK RUBBER
5	<a href="#">1102.00065.00</a>	Optional colored handle HANDLE W/MAGNET ASSY, RED	
5	<a href="#">1102.00066.00</a>	Optional colored handle HANDLE W/MAGNET say, GREEN	
5	<a href="#">1102.00067.00</a>	Optional colored handle HANDLE W/MAGNET ASSY, ORANGE	

## MBS 1220 regular plastic brew baskets

<a href="#">B014218BN2BK</a> (coffee) 13"X5" Complete replacement		
<a href="#">B015140G2BK</a> (tea) 15" X 5 ½ MBS-1221 SHORT ONLY Complete replacement		
<a href="#">B015280BN2BK</a> (coffee) 15"X5 ½ MBS-1221 SHORT ONLY Complete replacement		
Replacement colored plugs for plastic brew basket handles		
<a href="#">1023.00191.00</a>		PLUG, BB HANDLE, GREEN
<a href="#">1023.00190.00</a>		PLUG, BB HANDLE, RED
<a href="#">1023.00180.00</a>	PLUG, BB HANDLE, BLUE	
<a href="#">1023.00192.00</a>	PLUG, BB HANDLE, ORANGE	
<a href="#">1023.00194.00</a>	PLUG, BB HANDLE, BLACK	
<a href="#">1023.00195.00</a>	PLUG, BB HANDLE, BROWN	

	Complete tea and iced tea 13"X5" brew basket <a href="#">B026000G2BK</a>		
	#	Part #	Description
	1	1023.00416.00	13"X5" Tea or Iced Tea , MULTI-ORIFICE BREW BASKET, BLACK
	2	<a href="#">1024.00060.00</a>	STRAINER, SILICONE
	3	(see #6)	See #6 Orifice plate (0.140" installed by factory)
	4	1023.00330.00	ORIFICE HOLDER NUT,,
	5	<a href="#">1023.00191.00</a>	PLUG, BB HANDLE, GREEN
6	<a href="#">1023.00185.00</a>	ORIFICE, SET OF 9, MBS-1200 BREW BASKET	

## Hot Water Faucet Relocation Instructions

### WARNING!

All work to be performed by qualified personnel familiar with hot beverage equipment repair

The FETCO MBS brewer hot water faucet may be relocated from the front to the right or left side using kit 1000.00140.00

### Brewer Setup

1. Relocation of the hot water faucet is best performed before the MBS-1221 is installed.
2. If relocating the hot water faucet for a working installed MBS-1221 - disconnect the water and electrical lines and completely drain the hot water tank.
3. Remove the universal brewer shelf and front and top covers to access the hot water and internal connections.

### Remove the factory installed hot water faucet and install front panel plug

1. Review Illustration 1 below. Remove the tube and tank fitting from the hot water tank
2. Pull the clamp back from the faucet tube fitting and unscrew the backer nut to remove the faucet.
3. Place the hot water plug into the opening, place washer and spacer from the back and install screw.

NOTE: **WARNING: The plug and spacer must be installed into the front panel opening.**

### Installing the relocation faucet

Review Illustration 2: User side mounted faucet connection

1. Select side to install the side faucet, right or left side as desired. Remove the enclosure plug from that side.
2. Install the faucet and tighten the backer nut .
3. Push the angled tank fitting into the hot water tank where the original straight fitting was located.
4. Bring the faucet connector tube to the side where the faucet will be relocated.
5. Check that the clamp is on the tube and push the faucet tube on the faucet tube fitting and tighten the clamp on the tube fitting
6. Inspect all connections that they are intact and clamped over the fittings.
7. Reinstall water and power connections, turn brewer "ON: and inspect for leaks.
8. Reattach covers

Illustration 1: Factory default faucet connection

Illustration 2: User side mounted faucet connection

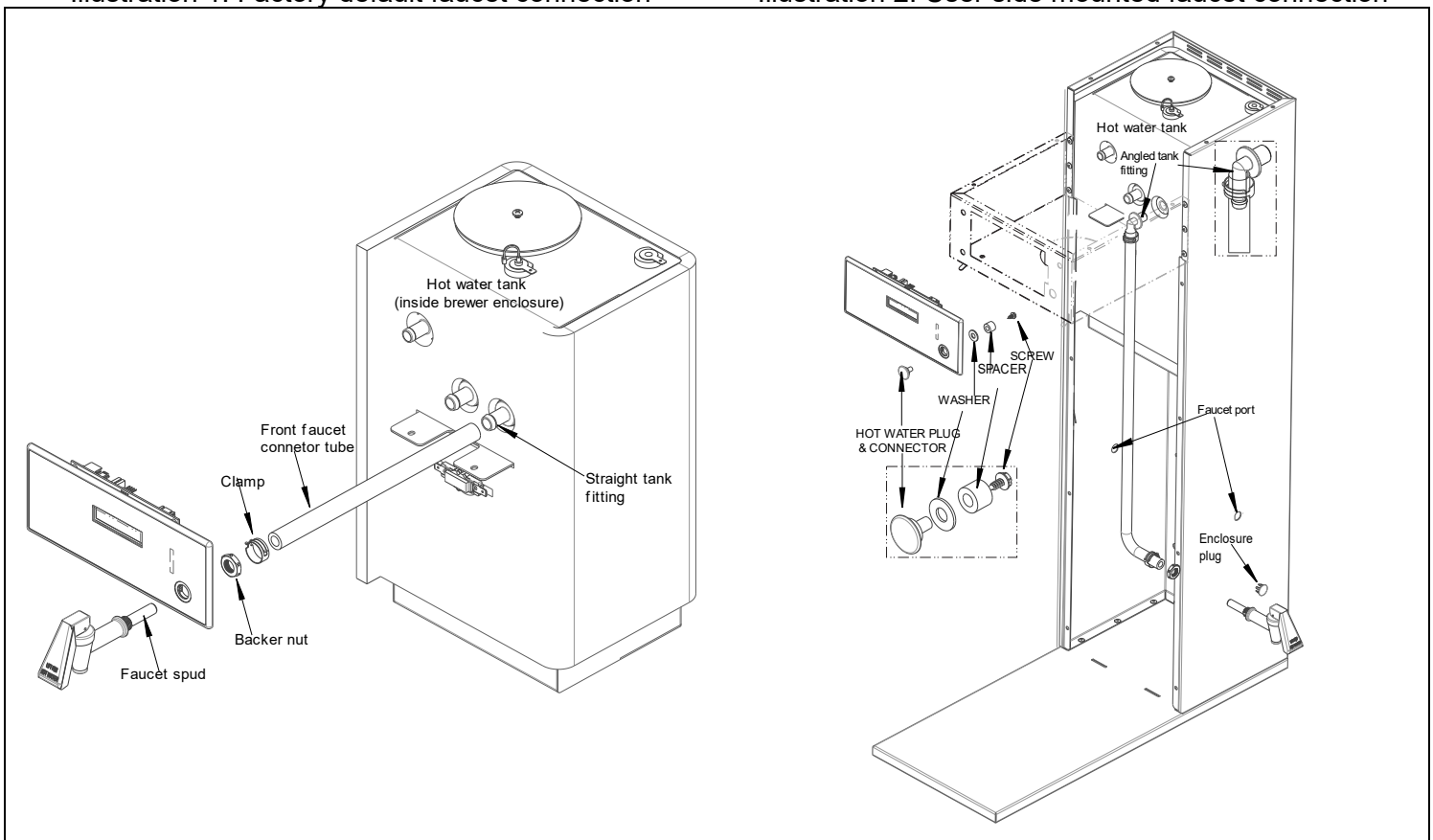



# THE URNEX SYSTEM™

BEHIND EVERY GREAT CUP

## TABZ TEA CLEAN™ TABLETS

Tea Brewer Cleaner

- Cleans brew basket and serving vessel in one simple step.
- Specially formulated for the removal of tea stains from tea brewers.
- Regular cleaning ensures fresh tasting brewed tea and properly maintained brewing equipment.
- Tablet form for easy and controlled dosing helps reduce waste and reduce operator error.



### Instructions For Use:

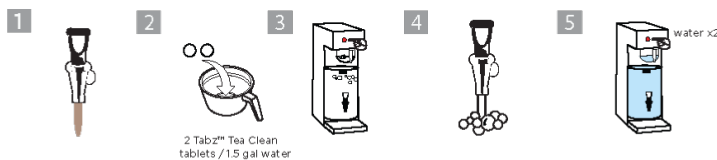

### Case and Pallet Information:

UNIT	CASE	PALLET
Code: 15-T61-UX120 Inner UPC: 7546316037 57 Contents: 120 tblt jar (4.0 g x 20 mm) Per case: 12 jars	Code: 15-T61-UX120-12 Barcode: 107546316 03754 Inches (Lx W x H): 11.25 x 8.50 x 8.50 Centimeters: 28.6 x 21.6 x 21.6 Weight: 14.6 lbs (6.6 kg)	Per Pallet: 102 cases Layout: 6 layers of 17 cases Weight: 1,525 lbs (692 kg) Height: 57 in. (1.45 m)

Umex Brands, LLC  
700 Executive Blvd | Elmsford, NY 10523 USA  
Tel: +1-914-963-2042 Fax: +1-914-963-2145  
info@urnex.com | www.urnex.com



NSF Protocol for Health Effects and Corrosivity of Commercial Espresso Machine Chemical Cleaners (2018)



URNEX® CARE CATEGORY  
**TEA**



