



The Signature of Quality®

INSTALLATION & OPERATION INSTRUCTIONS

RSSM3078SC & RSSM3078SC-2 Self-Contained



KEEP THIS MANUAL FOR FUTURE REFERENCE

Engineering and technical data are subject to change without notice.

TABLE OF CONTENTS

INTRODUCTION	1
WARNING LABELS AND SAFETY INSTRUCTIONS	2
BASE COMPONENT LAYOUT	3
PRE-INSTALLATION PROCEDURES	4
Inspection for Shipping Damage	4
INSTALLATION INSTRUCTIONS	4
Grill Removal	4
<i>Front Base Grill Removal</i>	4
<i>Rear Base Grill Removal</i>	5
Removing Case from Shipping Skid	5
Removing Packaging Material	5
Leveling the Case	5
Condensate pump	5
Cleaning for Initial Setup	6
Lights	6
<i>Standard LED Top Light</i>	6
<i>Standard LED Shelf Lights</i>	6
ELECTRICAL CONNECTION AND GROUNDING INSTRUCTIONS	7
Electrical Supply Wiring	7
Standard Power Cord	7
Optional Permanent Connection	7
OPERATING INSTRUCTIONS	8
Control Description	8
<i>Light Switch</i>	8
<i>Power Switch (Units Manufactured After 2/1/18)</i>	8
<i>Electronic Temperature Control</i>	8
Using the Electronic Temperature Control	9
<i>Button Overview</i>	9
<i>Control On/Off</i>	9
<i>Adjusting the Set Point</i>	10
<i>Entering Manual Defrost Mode</i>	10
<i>Error codes</i>	10
Initial Start-Up	11
Digital Display	11
Placing Product in the Case	11
Dual Pressure Control (Self-Contained Models Only)	12
Energy Saving Night Curtain	12
Shelves	13
Periodic Maintenance (Units Manufactured Before 02/01/18)	14
<i>Cleaning the Condenser Coil</i>	14
<i>Cleaning the Case Interior</i>	14
Periodic Maintenance (Units Manufactured After 02/01/18)	15
<i>Cleaning the Condenser Filter</i>	15
<i>Cleaning Condenser Coil</i>	16
<i>Cleaning Case Interior</i>	16
ELECTRONIC CONTROL PARAMETERS AND EXPLANATION OF OPERATION	17

Electronic Control Parameters	17
Operation	17
Defrost Cycle	18
Standard Control Settings	19
Error Codes	20
Minimum Run Timer Feature.....	20
Maximum Run Timer Feature.....	21
REFRIGERATION OPERATION.....	21
Self-Contained Models.....	21
Self-Contained Refrigeration Operation	21
CLEANING INSTRUCTIONS	21
Condenser Coil and Condenser Coil Filter Cleaning	21
Condensate Pump Cleaning	21
Acrylic Air Deflector Cleaning.....	22
Daily Cleaning.....	22
Weekly Cleaning.....	23
SERVICE INFORMATION.....	24
Pre-Service Checklist.....	24
<i>Case Does Not Operate</i>	24
<i>Case Temperature is Too Warm</i>	24
<i>Lights Do Not Operate</i>	25
<i>Condensate Pump Overflow</i>	25
<i>Special Service Situations</i>	25
SALE & DISPOSAL	26
Owner Responsibility	26
REFRIGERATION AND ELECTRICAL DATA.....	26
REPLACEMENT PARTS - MODEL RSSM3078.....	27
RSSM3078 DISPLAY AREA AND VOLUME.....	28
WIRING DIAGRAMS, 120V/60HZ.....	29
SELF-CONTAINED RSSM3078SC (MFG'D BEFORE 2/1/18).....	29
SELF-CONTAINED RSSM3078SC-2 (MFG'D AFTER 2/1/18).....	29
WIRING DIAGRAM, 220V/50 OR 60HZ.....	30
SELF-CONTAINED RSSM3078SC (MFG'D BEFORE 2/1/18).....	30
SELF-CONTAINED RSSM3078SC-2 (MFG'D AFTER 2/1/18).....	30
PROPOSITION 65 WARNING.....	31

INTRODUCTION

Thank you for purchasing a Federal Industries RSSM3078, Refrigerated Self-Serve Merchandiser. This manual contains important instructions for installing and servicing the RSSM3078, as well as a repair parts list. It is important that all documents be carefully reviewed prior to installing and servicing of the case.



NOTICE

Read this manual before installing your case. Keep this manual and refer to it before doing any service on the equipment. Failure to do so could result in personal injury or damage to the case.



NOTICE

Installation and service of the electrical components in the case must be performed by a licensed electrician.

The portions of this manual covering components contain technical instructions intended only for persons qualified to perform electrical work.



DANGER

Improper or faulty hookup of electrical components in the case can result in severe injury or death.

All electrical wiring hookups must be done in accordance with all applicable local, regional, or national standards.

NOTE: UNIT MUST BE GROUNDED

SERIAL NUMBER

Record the model and serial numbers of the case in the spaces below for easy reference. Always refer to both model and serial numbers in your correspondence regarding the case.

Case Model Number: _____

Serial Number: _____

This manual cannot cover every installation, use, or service situation. If you need additional information, call or write us:

WARRANTY/TECHNICAL SERVICE DEPARTMENT

Parts Town

1200 Greenbriar Dr.

Addison, IL 60101

Toll Free (833) 238-8168

Email: techservice@partstown.com



WARNING LABELS AND SAFETY INSTRUCTIONS



This is the safety-alert symbol. When you see this symbol on your case or in the manual, be alert to the potential for personal injury or damage to your equipment.

Be sure to understand all safety messages. Always follow recommended precautions and safe operating procedures.



NOTICE TO EMPLOYERS

You must make sure that everyone who installs, uses, or services this case is thoroughly familiar with all safety information and procedures.

Important safety information is presented in this section and throughout the manual. The following signal words are used in the warning and safety messages:

DANGER: Severe injury or death will occur if you ignore the message.

WARNING: Severe injury or death can occur if you ignore the message.

CAUTION: Minor injury or damage to your case can occur if you ignore the message.

NOTICE: This is important installation, operation, or service information. If you ignore the message, you may damage your case.

The warning and safety labels shown throughout this manual are placed on your Federal Industries case at the factory. Follow all warning label instructions. If any warning or safety labels become lost or damaged, call Federal Industries' customer service department at 1(800) 356-4206 for replacements.



This label is located on the back of the display case and on the front of the case behind the access panel.

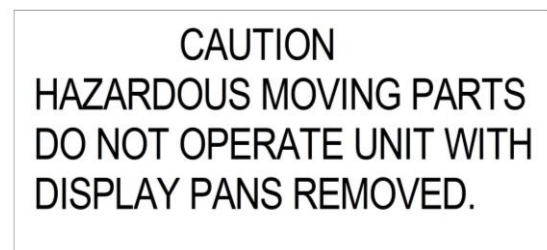

This label is located below the display pan

BASE COMPONENT LAYOUT

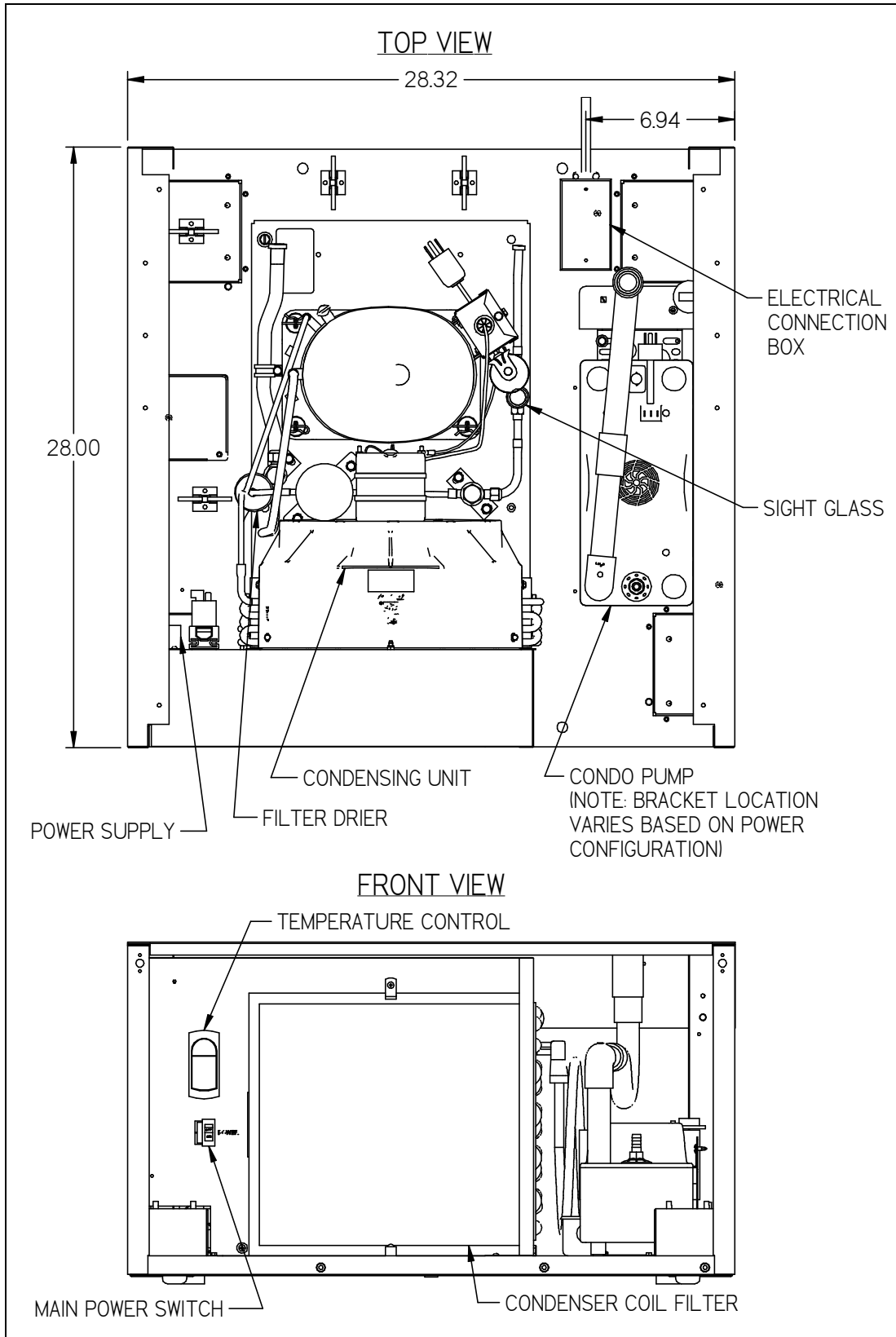

PRE-INSTALLATION PROCEDURES

Inspection for Shipping Damage

You are responsible for filing all freight claims with the delivering truck line. Inspect all cartons and crates for damage upon arrival. If there is damage to shipping crates, cartons, or if a shortage is found, note this on (all copies) of the Bill of Lading prior to signing.

If damage is discovered when the case is uncrated, immediately call the delivering truck line. Follow-up the call with a written report indicating concealed damage to your shipment. Ask for an immediate inspection of your concealed damaged item. Crating material must be retained and shown to the inspector from the truck line.

INSTALLATION INSTRUCTIONS

Locating the Display Case

NOTE: This case is designed for indoor use only.

The case should be located where it is not subjected to the direct rays of the sun, heating ducts, grills, radiators, or ceiling fans, nor should it be located near open doors or main door entrances. Avoid locations where there is excessive air movement or air disturbances. Avoid high humidity locations, such as near other cases with water misting or fogging devices.

The condenser air inlet is located on the front left of the case. The condenser air outlet is located on the right front of the case. Do not block these vents. Do not place the case in a location where the air inlet is near a source of heat.

Grill Removal



WARNING: Electrical shock hazard. Do not operate unit with panels removed.

Both front and rear base grills must be removed for merchandiser installation.

Front Base Grill Removal

On all cases manufactured *before 02/01/2018*, there is (1) front base grill. It is secured at the top with (2) fast lead captive screws. There are tabs on the bottom of the grill that insert into slots on the base. To remove the front grill, start by removing the (2) fast lead captive screws. Next, pivot the top of the grill away from the case while lifting it to free grill tabs from the slots in the base.

On all cases manufactured *after 02/01/2018*, there are (2) front base grills. They are held by a pocket at the top and fasteners at the bottom. The left front grill is held at the bottom by (1) thumbscrew, allowing easy removal for access to the control, the power switch, and the condenser air filter. The right front grill is held by (2) Philips head screws. To remove a front grill, start by removing the hardware at the bottom. Next, lower the grill while rotating the bottom away from the case to free grill from the top pocket. *NOTE: The left grill must be removed prior to the right grill.*

Rear Base Grill Removal

The rear base grill is secured with (5) self-threading screws.

Both base grills must be replaced after merchandiser installation. All base grills must be in place for proper operation of the merchandiser.

Removing Case from Shipping Skid



CAUTION: If a Johnson bar or pry bar is used to move the case, make certain that the case is lifted under the welded steel frame, and not by the end panels of the case. Damage to the ends will result from lifting under the end panels.

Move the case as near as possible to the final location before removing it from the shipping skid. Remove the front and rear base grills as outlined above in Grill Removal. Remove the (three or four sets of bolts, nuts, and washers depending on case size) that secure the case to the shipping skid. The hardware used to mount the case to the shipping skid can be discarded at this point.

Removing Packaging Material

Remove the bubble wrap and packing material for all shelves, etc. If it is necessary to remove tape residue from various materials, use cleaning compounds recommended in the CLEANING INSTRUCTIONS chapter, (Pg. 21).

Leveling the Case

The case must be level for proper drainage of defrost water to the condensate evaporator or condensate pump.

Check the level of the case along the front rail and along the top of the display pan. Where applicable, adjust the (4) levelling feet on the base to level the case. If levelling is required and the case is not equipped with levelling feet, shim under the case frame as needed to level the case. It is recommended that the leveled case be sealed to the floor with an NSF Listed Sealant.

Condensate pump

Check that the condensate drain line has not been dislodged during shipment, and that the drain trap terminates properly into the water reservoir of the pump.

Attached to the pump discharge port is a 25' length of 3/8" ID braided vinyl hose. Verify that the condensate hose has not become disconnected during shipment. The vinyl hose exits the rear base grill and is routed up the rear of the case. It is clamped to the rear of the case in multiple locations. The vinyl condensate hose must be installed by qualified personnel only. The hose needs to be routed properly with no kinks in the hose at time of installation, and vertical lift cannot exceed 20'. *NOTE: On cases equipped with casters, it is necessary to allow adequate slack in the hose so the case can be rolled away from the wall. This is accomplished by creating a loop behind the case using 6' of hose.*

Cleaning for Initial Setup

For initial setup, clean the case as outlined in the "Weekly Cleaning" section (Pg. 23) of the "CLEANING INSTRUCTIONS" chapter of this manual.

Lights

Standard LED Top Light

The case comes with one standard led top light internally wired to the power source. The light switch is in the top light housing under the top canopy.

Standard LED Shelf Lights

The case comes with standard LED shelf lights. Be certain that the shelf light cords are completely inserted into the sockets in the end of the light. Improper or incomplete shelf light cord and socket connection may cause arcing, causing damage to the plugs and sockets.

The power supply used on this case allows removal of one or more shelf lights without affecting the remaining lights. However, turn the light switch to the "off" position before connecting or disconnecting any light cords.

ELECTRICAL CONNECTION AND GROUNDING INSTRUCTIONS

Electrical Supply Wiring



DANGER: Improper or faulty hookup of electrical components in the display case can result in severe injury or death.

THIS CASE MUST BE GROUNDED

Standard Power Cord

All standard RSSM3078 Units have an 8' long power cord and plug, per the electrical specifications of the case. Before plugging the case in, use the information found on the case's electrical rating plate to verify that the circuit to be used will meet the case's electrical requirements.

Optional Permanent Connection

- Only a licensed electrician must perform all case electrical connections.
- All electrical wiring hookups must be done in accordance with all applicable local, regional, or national electrical standards.
- A separate circuit for each display case is required to prevent other appliances on the same circuit from overloading the circuit and causing malfunction.
- The electrical service must be grounded upon installation.
- See the electrical data plate located at the rear of the case for circuit load and wire current capacity.
- The electrical connection box is accessible from the rear of the case. Power Supply wiring can be routed through the floor of the base frame or through the access hole in the rear of the unit. Remove the electrical box cover to access the electrical connections.

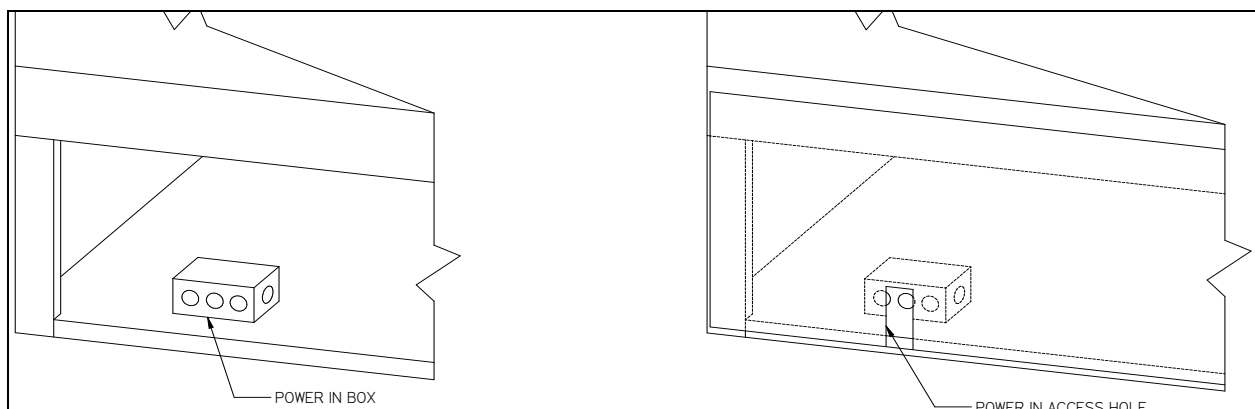

OPERATING INSTRUCTIONS



NOTICE: This refrigerated display case is designed to operate at 38° to 40° F under ambient conditions not to exceed 75° F and 55% relative humidity. Exceeding these limits will result in poor case performance.

Control Description

Light Switch

The unit has a light switch for switching the unit's interior lights on/off. The light switch is located on the top light housing, under the canopy.

Power Switch (Units Manufactured After 2/1/18)

The unit has a power switch that turns off power to the entire unit, including the condensate evaporator and lights. The electronic temperature control is located behind the front grill on the left-hand side of the case. To access the electronic temperature control, remove the front grill as outlined in the "Grill Removal" (Pg. 4) section of the chapter titled "INSTALLATION INSTRUCTIONS."

Electronic Temperature Control

The temperature control allows the user to adjust the temperature of the display merchandiser to meet their needs. When not in Adjust Mode the readout displays the relative interior case temperature.

The electronic temperature control is located behind the front grill on the left-hand side of the case. To access the electronic temperature control, remove the front grill as outlined in the "Grill Removal" (Pg. 4) section of the chapter titled "INSTALLATION INSTRUCTIONS."

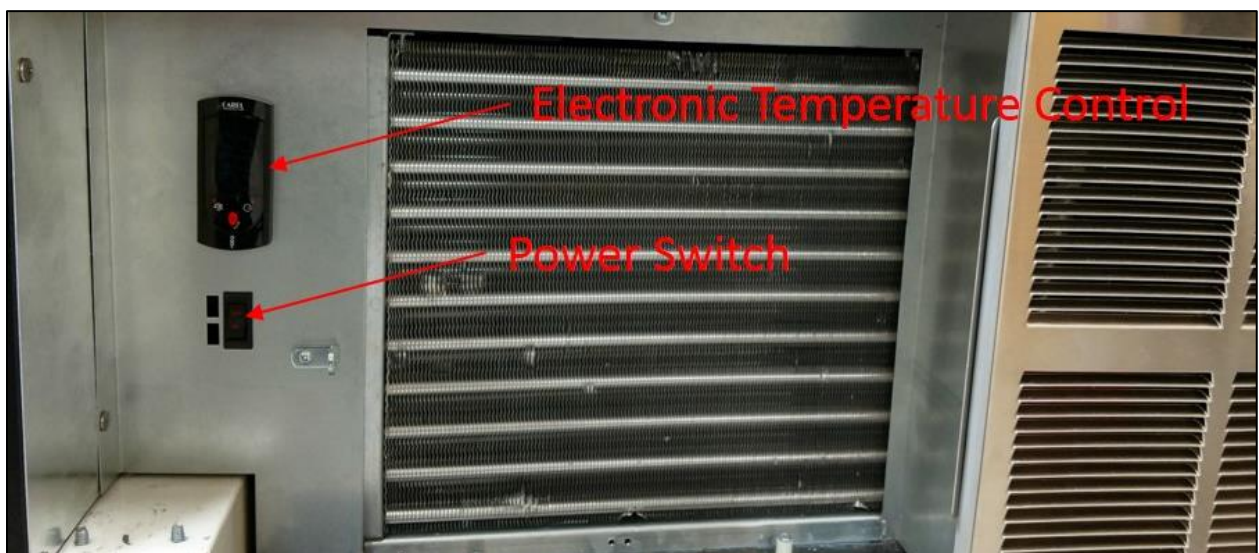

Using the Electronic Temperature Control

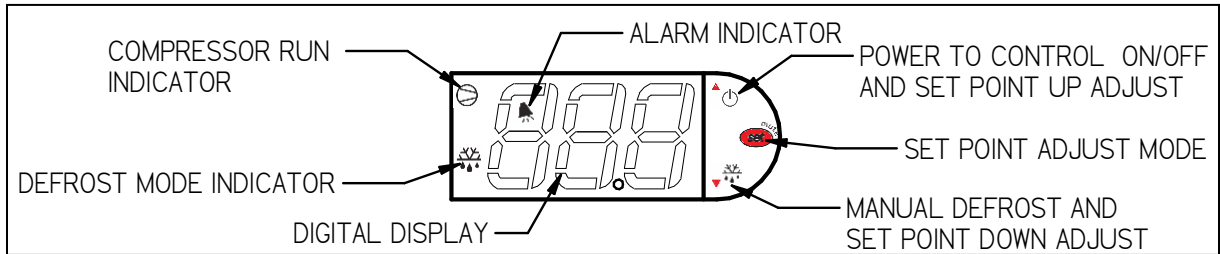

Instructions to operate the control are provided in the preceding subsections. For additional information regarding the control, refer to the chapter titled “ELECTRONIC CONTROL PARAMETERS AND EXPLANATION OF OPERATION” (Pg 17).





Button Overview

	Press and hold this button for 3 seconds to turn the system on (if off) or off (if on). This button is also used to adjust the set point when in Set Point Adjust Mode.
	Press to enter Set Point Adjust Mode, confirm set point changes, and mute alarms.
	Press and hold this button for 3 seconds to initiate a Manual Defrost (and cancel defrost if initiated). This button is also used to adjust the set point when in Set Point Adjust Mode.



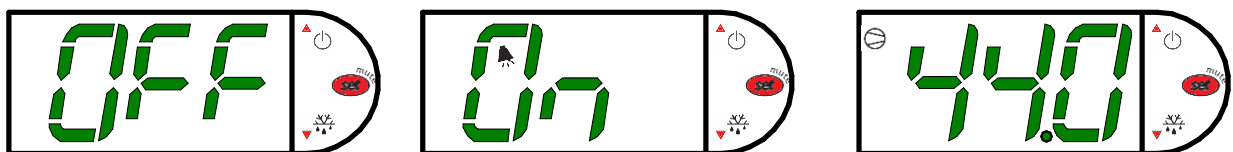

Control On/Off

To turn the refrigeration control power on, press and hold  for approximately five seconds. The display will read “On” while the button is depressed. When the control powers on, the display will read the relative current case temperature (on initial startup this will be room temperature). The compressor run indicator  will illuminate on the display, meaning that the compressor is running. (Note: The control may already be in the on mode when shipped from factory).

To turn the refrigeration control power to off, press and hold  for approximately five seconds. The display will read “Off” while the button is depressed. When the control powers off the display will alternate between the relative current case temperature and “Off”. The compressor run indicator  will not be illuminated on the display. When refrigeration control is in the off-mode, cabinet lights and evaporator fans will continue to operate. However, while in off-mode the compressor will remain off causing the case to gradually reach room temperature.







Adjusting the Set Point

The set point determines how cold the display case will hold food and beverage. To adjust the set point, press and hold the  button for approximately 5 seconds until a number flashes on the display. The number displayed on the screen will indicate the present set point. Next, press the  button to increase the set point number (colder case temperature), or press the  button to decrease the set point number (warmer case temperature). There are (9) available set points, with a higher set point number corresponding to colder case operation - setting “9” is the coldest and setting “1” is the warmest. After choosing the desired setting press the  button again to confirm the setting.



Entering Manual Defrost Mode

The control is programmed to automatically initiate a defrost by two different methods, involving time and temperature, as outlined in the “Defrost Cycle” section (Pg. 18) of “ELECTRONIC CONTROL PARAMETERS AND EXPLANATION OF OPERATION.” While it is uncommon that the automatic defrost cycles would insufficiently defrost the case, a Manual Defrost mode is available if this situation arises. Note: The control will not allow the initiation of a manual defrost within 30 minutes of completion of another defrost cycle, manual or automatic.

To initiate a manual defrost, hold the  button for approximately 5 seconds. The control will display “dEF” while the button is depressed. The manual defrost begins when the defrost mode indicator  is illuminated on the display. Once the manual defrost is initiated, the control display screen will resume showing the case temperature, and the defrost mode indicator  will be illuminated. When the manual defrost is complete, the defrost mode indicator  will turn off and the compressor run indicator  will illuminate to indicate that the compressor is running.



Error codes

In the event of a controller or display case malfunction, an alarm will sound and the alarm indicator  will appear on the display. An error code or codes will flash intermittently on the display. If there are multiple codes, the display will continuously cycle through them. An example of an error code can be observed in the following image, where error code “E0” is displayed.



A list of error codes, possible causes of said codes and potential resolutions can be found in the “Error Codes” section (Pg. 10) of the “ELECTRONIC CONTROL PARAMETERS AND EXPLANATION OF OPERATION” chapter.

Mute: To mute the alarm, press and release the wrench button. The red ringing bell indicator and all error codes will still be displayed. When the fault is remedied the control will return to normal operation and automatically clear the codes from the display.

Initial Start-Up

After completing the items in the installation section of this manual and becoming familiarized with control operation, the case is ready to be put into service. On self-contained models, the service valves on the refrigeration system are back-seated when the unit leaves the factory.

When starting a warm case, it is recommended that the temperature control setting is in the middle of the range, such as set point 5. After the unit has gone through several cycles, adjust the control to a warmer or colder setting to achieve the desired product temperature. **NOTE:** Allow refrigerated models to run for at least two hours before placing pre-chilled product in the case.

Nearly all open refrigerated merchandisers operate better when loaded with product than when empty. Therefore, it may be necessary to make additional control setting adjustments after the case is loaded with product. Once the aforementioned initial two hour startup period has passed, check case operating temperatures with product in the case.

Open refrigerated merchandisers are not intended as storage refrigerators and will not “pull down” room temperature products efficiently. Load the case interior with pre-chilled product only.

Digital Display

This unit is equipped with a CAREL temperature control with Digital Display. The Display shows discharge air temperature (not shelf temperature).

Placing Product in the Case

NOTE: After the initial case startup, allow the case to run for at least two hours before placing product in the case. Once this two-hour period has passed, products may be placed in the case.

- Do not overload the case with product to a point where the top air discharge grill or the bottom air intake grill are blocked.
- Make sure that the air curtain created by the discharge air is not blocked by product.
- Do not exceed 100 pounds of weight per shelf. Heavy product should be evenly distributed across the entire shelving area.
- Determine desired shelving location and angle before placing product in the case. All product must be removed to readjust shelf location and/or angle.

LOAD THE CASE INTERIOR WITH PRE-CHILLED (38° F OR COLDER) PRODUCTS ONLY.

Dual Pressure Control (Self-Contained Models Only)

A dual pressure control (shown below) is located on the left side of the base. The low-pressure control portion of the device is a safety feature to turn off the compressor in the event of refrigeration loss. The low-pressure control is factory set to cut in (turn the compressor on) at 80 PSIG and cut out (turn compressor off) at 20 PSIG.

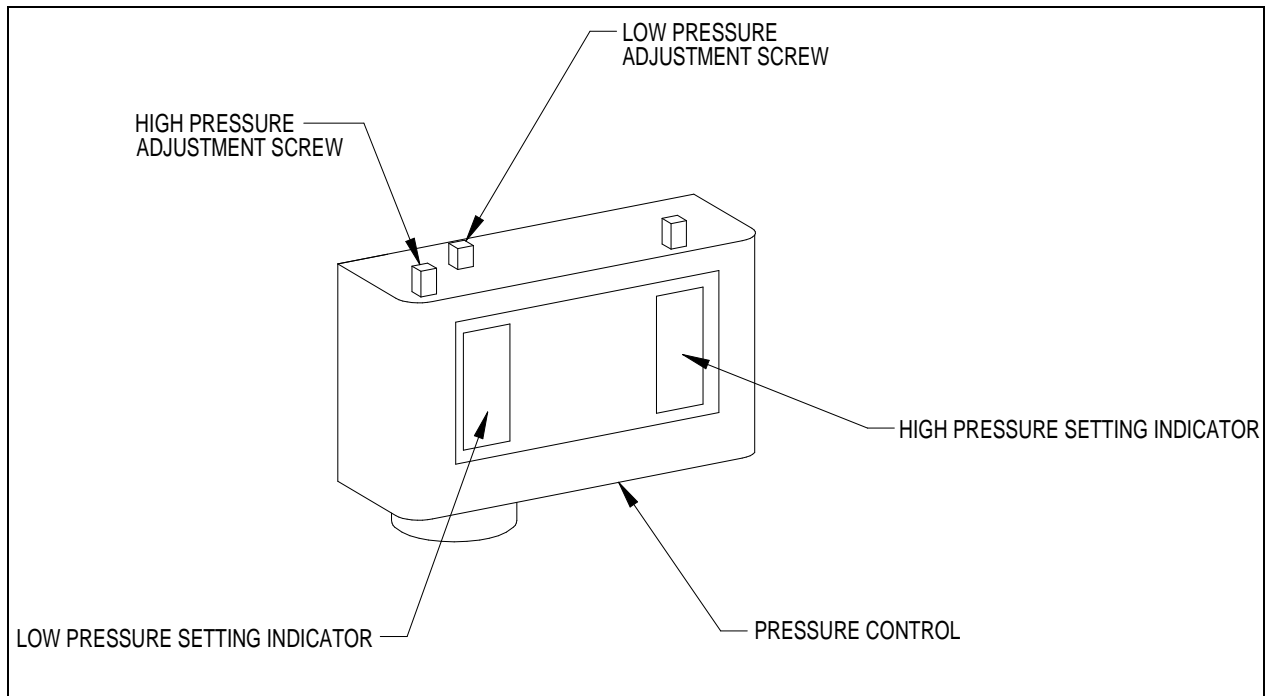

The high-pressure control portion of this device is factory set at 385 PSIG. This is a safety device and is not adjustable.

Energy Saving Night Curtain

This unit is equipped with an energy saving night curtain. The night curtain is located in the top inside front of the canopy. When the case is not in use, pull the night curtain down and attach to the snap or hook located in the center of the front panel, just below the clear acrylic air deflector.

Shelves

The RSSM3078 has 15" solid metal shelves that are installed at the factory.

The shelves are adjustable in 1-5/8" increments. Before repositioning the shelves, unplug the shelf light cords. To adjust the shelves, remove the shelf from the shelf standard and reposition as desired. If optional shelf lights are installed, it will be necessary to unplug the shelf light cord before repositioning the shelf.

The shelves can be installed horizontally or slanted at a 10° downward angle. To change the shelf angle, lift the rear of the shelf until the brackets can be repositioned in the shelf standard slots. This is illustrated in the diagram below.

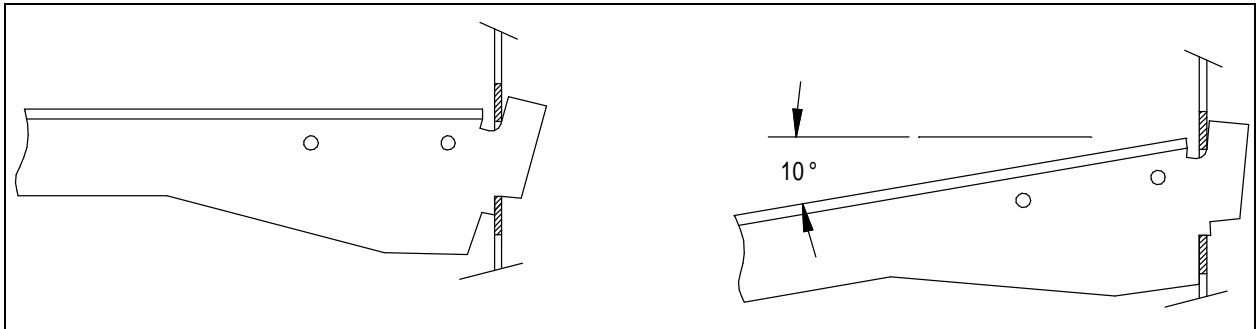

CAUTION:



Do not place more than 100 lbs. of product on a shelf.

Damage to the shelf standard may occur if the shelf is overloaded.

Periodic Maintenance (Units Manufactured Before 02/01/18)

Cleaning the Condenser Coil

It is very important that the condenser coil is cleaned twice per month for proper refrigeration performance and to prevent compressor failure. **FAILURE TO CLEAN THE CONDENSER COIL WILL VOID THE COMPRESSOR WARRANTY.**

1. Disconnect the power to the unit.
2. Remove the front grill and vacuum the front surface of the condenser coil, moving the vacuum nozzle vertically. This should be done every two weeks. **NOTE: Be careful not to bend or otherwise damage the condenser coil fins. Moving the vacuum nozzle horizontally will cause bend the fins. Bent coil fins will affect condensing unit performance.**



Cleaning the Case Interior

1. The case interior should be wiped down daily and thoroughly cleaned on a weekly basis. Refer to the “Daily Cleaning” (Pg. 22) and “Weekly Cleaning” (Pg. 23) sections in the “CLEANING INSTRUCTIONS” chapter of this manual.

Periodic Maintenance (Units Manufactured After 02/01/18)

Cleaning the Condenser Filter

This refrigerated case is equipped with a reusable condenser coil filter, which filters large dust particles from the air before it enters the condenser coil fins. It is very important that this filter be cleaned monthly to maintain proper refrigeration performance and prevent compressor failure. **FAILURE TO CLEAN THE CONDENSER FILTER WILL VOID THE COMPRESSOR WARRANTY.**

1. Disconnect power to the unit.
2. Remove the left-hand front base grill as outlined in Grill Removal section of this manual.
3. Rotate the L-bracket securing the filter until it no longer holds the filter.
4. Gently pivot the top of the filter towards the front of the case while lifting the filter to remove.
5. Wash the filter using warm soapy water. Rinse the filter and let it dry. **NOTE: Do not clean the filter in a dishwasher.**
6. Apply a generous coat of filter coat adhesive to both sides of the filter. (Filter coat adhesive is available through any restaurant supply chain distributor). **NOTE: Failure to coat the filter with a fresh coat of filter adhesive after cleaning will cause ineffective filter operation. This will lead to plugging of the condenser coil, affecting refrigeration performance and can cause compressor failure.**
7. Despite the presence of the filter, it is necessary to check and clean the condenser coil every 6 months or as necessary. Refer to the instructions outlined below in Cleaning Condenser Coil.
8. Reinstall the filter. Insert the bottom of the filter between the tabs and the condenser coil and pivot the filter top into place. Secure the filter by rotating the top L-bracket over the filter frame. *Note: L-bracket should fit snugly over the filter frame to prevent vibration.*
9. Reinstall the left-hand front base grill.

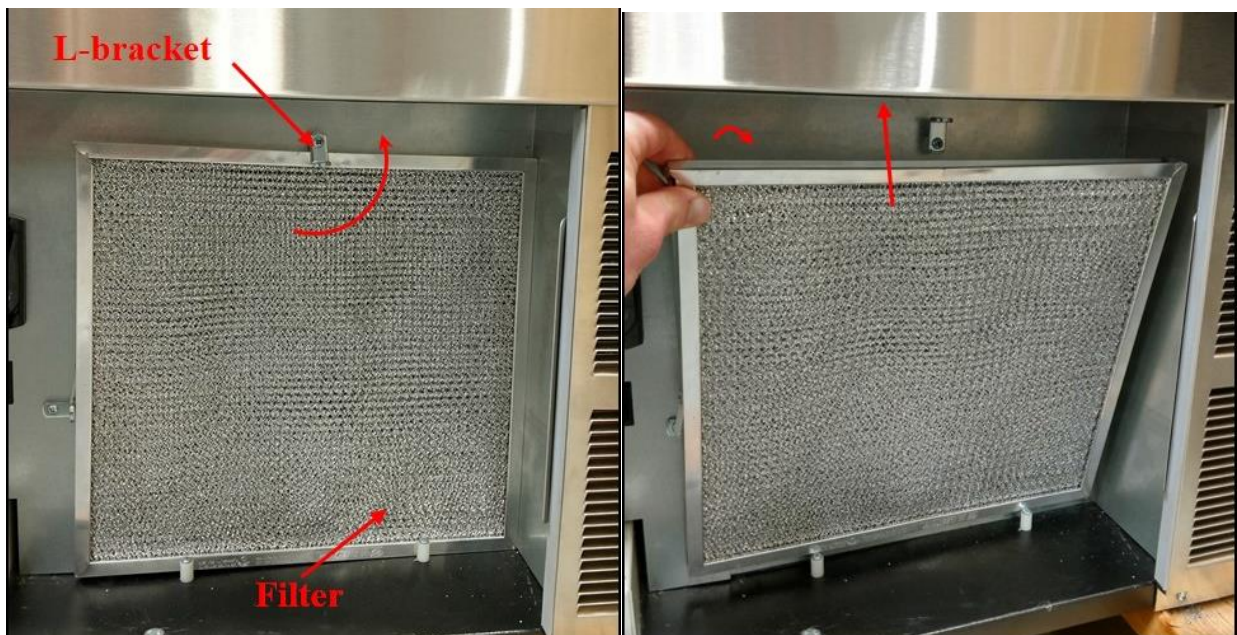

Cleaning Condenser Coil

Despite the presence of the filter, it is necessary to check and clean the condenser coil every 6 months or as necessary. **FAILURE TO CLEAN THE CONDENSER COIL WILL VOID THE COMPRESSOR WARRANTY.** The condenser coil is cleaned as follows:

1. Disconnect power to the unit.
2. Remove the left-hand front base grill as outlined in Grill Removal section of this manual.
3. Removed the condenser filter and clean it as outlined above in Cleaning Condenser Filter.
4. Vacuum the front surface of the condenser coil, moving the vacuum nozzle vertically. **NOTE: Be careful not to bend or otherwise damage the condenser coil fins. Moving the vacuum nozzle horizontally will cause bend the fins. Bent coil fins will affect condensing unit performance.**
5. Reinstall the filter. Insert the bottom of the filter between the tabs and the condenser coil and pivot the filter top into place. Secure the filter by rotating the top L-bracket over the filter frame. *Note: L-bracket should fit snugly over the filter frame to prevent vibration.*
6. Reinstall the left hand front base grill.



Cleaning Case Interior

1. The case interior should be wiped down daily and thoroughly cleaned on a weekly basis. Refer to the “Daily Cleaning” (Pg. 22) and “Weekly Cleaning” (Pg. 23) sections in the “CLEANING INSTRUCTIONS” chapter of this manual.

ELECTRONIC CONTROL PARAMETERS AND EXPLANATION OF OPERATION

Electronic Control Parameters

The control parameters are set at the factory and cannot be manually changed in the field. Control parameter changes can only be made by downloading a new set of parameters using a program chip supplied by Federal Industries. The pre-set control parameters are listed on the chart in the Settings Chart below.

Operation

The control uses two sensors, one located in the air stream and one located on the evaporator coil. The sensor in the air stream is referred to as the "Temperature Control Sensor." The sensor on the evaporator coil is referred to as the "Coil Sensor."

The Temperature Control Sensor is located inside the top air duct behind the honeycomb material and is labeled (TEMP). The sensor location is critical for proper operation on the unit. Do not move or relocate this sensor.

The Coil Sensor is strapped to the evaporator coil and is labeled (DEFROST). This sensor location is critical for proper operation of the unit. Do not move or relocate this sensor.

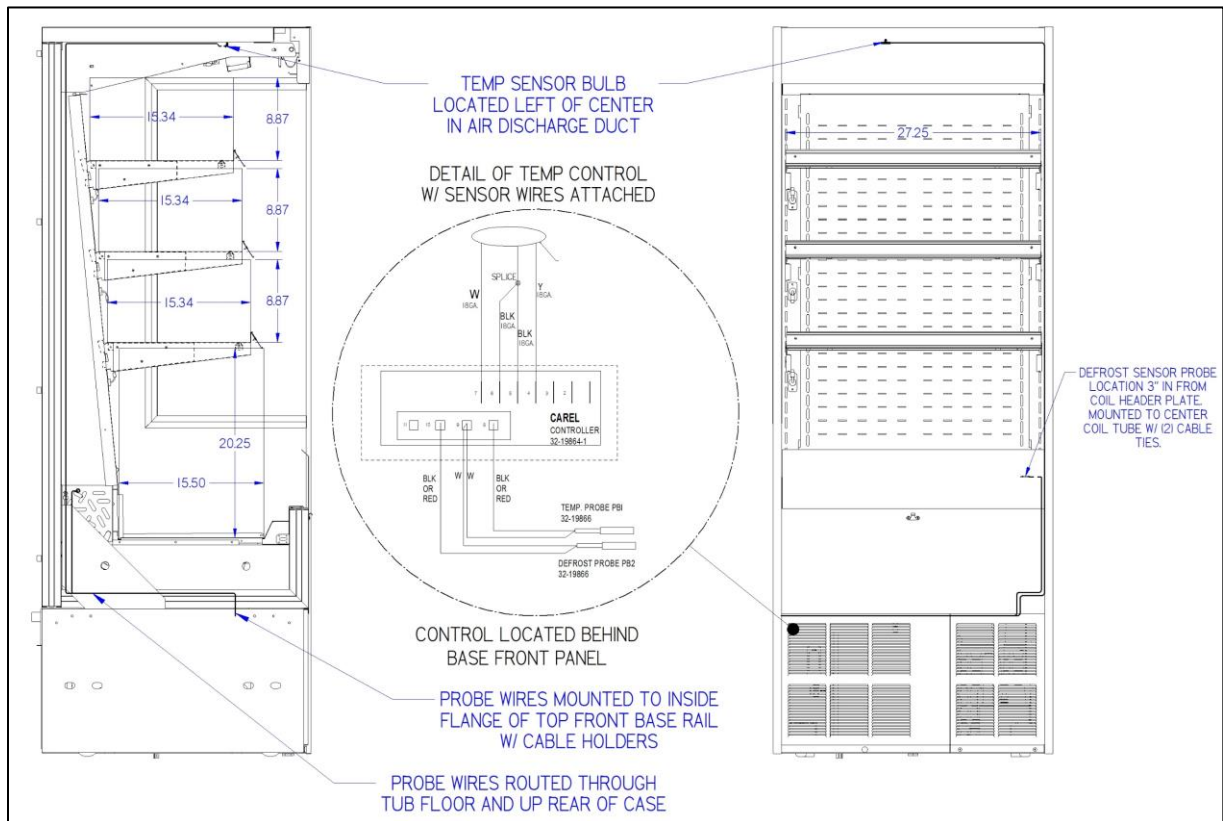

The temperature control is set to cut in at 39° F. The Temp control cuts out at 24° F at the coldest setting and 34° F at the warmest setting. The coldest setting is indicated by a “9” on the control display, and the warmest setting is indicated by a “1”.

Defrost Cycle

The control is programmed to initiate defrost by two different methods. There are three programmed defrost cycles in the control which will initiate a defrost cycle every 8 hours. As the unit does not have a time clock, the defrost cycles cannot be set for any specific time of day. The controller uses time to initiate the defrost cycle and temperature to terminate the defrost cycle. The controller also has an ‘On demand’ defrost feature that will initiate a defrost cycle if after 30 minutes into the refrigeration cycle the temperature differential between the evaporator temperature and the air temperature is greater than 15° F for a 5-minute duration.

Standard Control Settings

The control parameters are set at the factory and cannot be manually changed in the field. Control parameter changes can only be made by downloading a new set of parameters from a program chip supplied by Federal Industries. The following is a list of the standard control parameters as set at Federal Industries.

TAB	PARAMETER DESCRIPTION	RSSM3078
CONFIGURATION	Controller Operation Temperature Units	Degrees Fahrenheit
	Defrost Termination Method	Evaporator Sensor
SET-POINTS	Setting "1" Cut-In (Warmest Setting)	39°F
	Setting "1" Cut-Out (Warmest Setting)	34°F
	Setting "2" Cut-In	39°F
	Setting "2" Cut-Out	32.7°F
	Setting "3" Cut-In	39°F
	Setting "3" Cut-Out	31.5°F
	Setting "4" Cut-In	39°F
	Setting "4" Cut-Out	30.2°F
	Setting "5" Cut-In	39°F
	Setting "5" Cut-Out	29°F
	Setting "6" Cut-In	39°F
	Setting "6" Cut-Out	27.7°F
	Setting "7" Cut-In	39°F
	Setting "7" Cut-Out	26.5°F
	Setting "8" Cut-In	39°F
	Setting "8" Cut-Out	25.2°F
	Setting "9" Cut-In (Coldest Setting)	39°F
	Setting "9" Cut-Out (Coldest Setting)	24°F
COMPRESSOR	Compressor Minimum On Time	5 minutes
	Compressor Maximum On Time	60 minutes
DISPLAY	Defrost Display Lock (display indication during defrost)	SHOW CURRENT TEMPERATURE
DEFROST	Defrost Termination Temperature	45°F
	Time to First Defrost (hh:mm)	8 hr
	Time to subsequent Defrost	8 hr
	Defrost Max Duration	30 minutes

Error Codes

Error codes may be displayed if the controller or display case is malfunctioning. The following is a list of error codes that may be encountered, and potential resolutions.

ERROR CODES AND RESOLUTIONS			
CODE	DESCRIPTION	CAUSE	RESOLUTION
E0	Temperature probe error	Probe signal is interrupted or short-circuited	<ol style="list-style-type: none"> 1. Verify that probe wires and quick disconnect are secure in control. 2. Check probe resistance to table below. If 0 resistance is present check wiring insulation. If infinite resistance is present check for breaks in wiring (meter will likely read overload or very high in the mega-ohm range). 3. Ensure that probes are wired per the wiring diagram provided. 4. Replace probe if other remedies fail, or if probe resistance deviates from “Error! Reference source not found.” Error! Reference source not found.
E1	Defrost probe error	See E0	
EE	Unit parameter reading error	Operating conditions	<ol style="list-style-type: none"> 1. Remedy abnormal operating conditions. The control is rated to operate in a range of 14 to 122°F (-10 to 50°C) and less than 90%RH non-condensing. 2. Replace control if problem persists.
EF	Operating parameter reading error	See EE	

TEMPERATURE PROBE COMMON RESISTANCE CHART			
Probe Temp	Maximum Resistance [Ω]	Normal Resistance [Ω]	Minimum Resistance [Ω]
32°F(0°C)	27.83	27.28	26.74
77°F(25°C)	10.1	10	9.9
212°F(100°C)	1	0.97	0.94

Minimum Run Timer Feature

The unit controller is programmed so the condensing unit will run a minimum of 5 minutes, regardless of the control temp being satisfied. If the temperature control reaches the cut out set point before 5 minutes, the minimum run time setting in the control will keep the unit in a run cycle mode until the timer reaches 5 minutes. The refrigeration cycle will be off until the temperature control cut in temperature is reached.

This timer typically comes into effect in low ambient temperature and relative humidity conditions where the unit may cycle too frequently to maintain proper product temperature.

Maximum Run Timer Feature

In addition to a minimum run timer, there is also a maximum run timer. The unit controller is programmed so the condensing unit will continuously run a maximum of 60 minutes. If the unit has not reached the cut out temperature setting in 60 minutes, the unit goes into an off cycle.

This typically comes into effect in high ambient temperature and relative humidity conditions.

REFRIGERATION OPERATION

Self-Contained Models

Refrigeration R404 Charge	See Refrigeration and Electrical Data Pages

The self-contained models are shipped from the factory with a completely operational 404A refrigeration system and require no modifications or adjustments upon installation. The case must be installed as per the installation section of this manual to provide proper condensing air cooling.

Self-Contained Refrigeration Operation

The unit temperature is controlled by the Electronic control as outlined in the “Control Operation” section of this manual.

CLEANING INSTRUCTIONS

Condenser Coil and Condenser Coil Filter Cleaning

For instructions on how to clean the condenser coil and condenser coil filter, see the corresponding subsections in “Periodic Maintenance (Units Mfg’d Before 02/01/18)” (Pg. 14) and “Periodic Maintenance (Units Mfg’d After 02/01/18)” (Pg. 15) sections in the “OPERATING INSTRUCTIONS” chapter.

Condensate Pump Cleaning

Per Manufacturer’s Recommendation: Periodically check the condensate tank for grime or buildup. If cleaning is required, disconnect power for all maintenance. Clean the tank with soap and warm water only. **Do Not** use solvent cleaners.

Acrylic Air Deflector Cleaning



NOTICE: The clear acrylic air deflector requires special washing procedures to prevent hazing and yellowing of material.

NEVER USE paper towels (wet or dry) for cleaning or drying and never use a dry towel.

NEVER USE glass cleaner of any kind.

Lightly dust (not wipe) surface with a damp Micro Fiber towel or chamois. Once dusted, the surface can be washed using lukewarm water and a small amount of dishwashing detergent, such as Dawn or Joy. Use a Micro Fiber towel or chamois, applying only light pressure. The cloth or chamois must be kept free of grit by frequently rinsing. Rinse the surface with clear water and dry by blotting with a damp Micro Fiber towel or chamois.

Daily Cleaning

The case should be cleaned thoroughly, as described in the weekly cleaning section, before it is used for the first time.



NOTICE: Avoid splashing or soaking any electrical components with water to prevent electrical damage to the case.



NOTICE: Shut off lights and power switches and remove all products from case. Allow sufficient time for the unit to reach room temperature before proceeding with cleaning.



NOTICE: Remove all products from the case before proceeding with cleaning procedure.



NOTICE: The acrylic air deflector requires special washing procedures to prevent hazing and yellowing of the material. Clean as described in “Acrylic Air Deflector Cleaning” section (Pg. 21) of this manual.

Note: For major spills or foreign material buildup, use the complete cleaning method outlined in “Weekly Cleaning” section.

Note: Detergents are not recommended. To prevent scratching of surfaces, do not use abrasive cleaners or pads.

1. Saturate a rag in warm soapy water and ring out thoroughly. Wipe the complete interior of case and dry with soft dry towel.
2. The remaining exterior surfaces should be wiped down using any ammoniated cleaners or soapy warm water and dried with a soft dry towel.

- 3. IMPORTANT: Cleaning the clear acrylic plastic front air deflector requires special care to prevent hazing and yellowing of material. Clean as described in “Acrylic Air Deflector Cleaning” section of this manual.**

Weekly Cleaning



NOTICE: Avoid splashing or soaking any electrical components with water to prevent electrical damage to the case.



NOTICE: Turn off lights and power switches and remove all products from case. Allow sufficient time for the unit to reach room temperature before proceeding with cleaning.



NOTICE: Remove all products from case before proceeding with cleaning procedure.



NOTICE: The acrylic front air deflector requires special washing procedures to prevent hazing and yellowing of material. Clean as described in “Acrylic Air Deflector Cleaning” section (Pg. 21) of this manual.

Note: Detergents are not recommended. To prevent scratching of surfaces, do not use abrasive cleaners or pads.

1. Remove the interior shelving from the unit.
2. Saturate a rag in warm soapy water and ring out thoroughly. Clean all shelves and shelf brackets and dry with soft dry towel.
3. Saturate a rag in warm soapy water and ring out thoroughly. Clean the tower side panels and tower inner panels. Clean inside both tower ends. Dry with soft dry towel.
4. Clean the display deck(s) using warm soapy water and a brush. Rinse thoroughly and allow to dry. Wipe off the fan shroud assembly (do not rinse or submerge fan motors).
5. Clean the entire interior of the case using warm soapy water. Wipe off all soapy water with a damp cloth and allow to dry. (DO NOT use solvents such as Acetone, Benzene, Carbon Tetrachloride, and Lacquer Thinners)
- 6. IMPORTANT: Cleaning the clear acrylic plastic front air deflector requires special care to prevent hazing and yellowing of material. Clean as described in “Acrylic Air Deflector Cleaning” section (Pg. 21) of this manual.**
7. Reassemble all components in reverse order.

NOTE: Depending on the amount of usage and spillage of foreign material, it may be necessary to remove fasteners and disassemble parts to allow proper cleaning of the unit.

SERVICE INFORMATION

CAUTION!
RISK OF ELECTRIC SHOCK

DISCONNECT POWER
BEFORE SERVICING UNIT

Before any service work is performed on the case, make sure all power is disconnected to the case.

Service problems or request for repair parts from authorized service agencies, trained service personnel, or owners should be referred to:

WARRANTY/TECHNICAL SERVICE DEPARTMENT

Parts Town

1200 Greenbriar Dr.

Addison, IL 60101

Toll Free: (833) 238-8168

Email: techservice@partstown.com



Pre-Service Checklist

You may avoid the cost and inconvenience of an unnecessary service call by first reviewing this checklist of frequently encountered situations that can cause unsatisfactory case performance.



CAUTION: Before servicing case turn off the power at the main breaker or fuse box.

Case Does Not Operate

- Check for disconnected power supply.
- Check for tripped breaker or blown fuse.

Case Temperature is Too Warm

- Check that top air discharge grill and/or bottom air intake grill are not blocked.
- Check for a blocked or dirty condenser coil filter or condenser coil fins.
- Check that there are no outside air disturbances in or around the case(s). These disturbances can be caused by nearby doors or entrances, overhead ceiling fans or

air diffuser vents, direct sunlight, or other heat sources. The location of open refrigerated merchandisers is critical to case performance.

- Make sure that warm product is not being installed inside the case. All product must be pre-chilled prior to loading for proper case performance.
- Check temperature/pressure control for proper settings.
- Check cold air flow. Lack or complete absence of air flow may indicate a blocked evaporator coil or defective evaporator fan motor. Contact a qualified service company if there is no air flow inside of the case.

Lights Do Not Operate

- Check that light switch located in top light housing is “on”.
- Check that all shelf light cords are securely plugged into the sockets at the end of the light.

Condensate Pump Overflow

- Check that drain line is properly located in opening of condensate pump.
- Check that store conditions do not exceed 75° and/or 55% relative humidity for prolonged periods of time.
- Check that condensate pump is operating and that there are no kinks in the vinyl discharge tube.

Special Service Situations

There are rare occasions when the refrigerant charge must be evacuated from a case to perform service work. In those situations, Federal Industries recommends that the refrigerant charge be evacuated into a recovery system to prevent the possibility of hydrofluorocarbons (HFC's) from being released into the atmosphere. The release of HFC's into the atmosphere is a source of greenhouse gases.

If moisture or liquid is observed around or under a Federal Industries case, an immediate investigation should be conducted by qualified personnel to determine the source of the moisture or liquid. The investigation should determine if the moisture or liquid is due to case malfunction or a simple housekeeping problem. Note: Moisture or liquid around or under a case is a potential slip/fall hazard for persons walking by or working in the general area of the case. Any case malfunction or housekeeping problem that creates a slip/fall hazard around or under a case should be corrected immediately.

SALE & DISPOSAL

Owner Responsibility

If you sell or give away your Federal Industries case, you must make sure that all safety labels and the Installation-Service Manual are included with it. If you need replacement labels or manuals, they will be provided free of charge. Contact the Warranty/Technical Service Department at Parts Town at (833) 238-8168, or techservice@partstown.com.

Additionally, Parts Town should be contacted at the time of case sale or disposal so records may be kept of its new location.

If you sell or give away your case and you evacuate the refrigerant charge before shipment, Federal Industries recommends that the charge be evacuated into a recovery system to reduce the possibility of HFC's from being released into the atmosphere. The release of HFC's into the atmosphere is a source of greenhouse gases.

REFRIGERATION AND ELECTRICAL DATA

Model	RSSM3078SC		RSSM3078SC		RSSM3078SC	
POWER SUPPLY, VOLTS	120 Volts		220 Volts		230 Volts	
Frequency	60 Hertz		50 Hertz		60 Hertz	
Phase	1 Phase		1 Phase		1 Phase	
Number of Wires	2		2		2	
Refrigerant Charge (R-404A)	3 lbs		3 lbs		3 lbs	
Optimal Superheat Range	8-12 ° F		8-12 ° F		8-12 ° F	
Optimal Subcooling Range	1.5-6 ° F		1.5-6 ° F		1.5-6 ° F	
	AMPS	VOLTS	AMPS	VOLTS	AMPS	VOLTS
Compressor						
RLA	9.2	120	4.5	220/240	4.5	208/240
LRA	58.8	120	22.0	220/240	22.0	208/240
Condenser Fan Motor	2.0	120	0.5	220/240	0.5	220/240
Evaporator Fan Motor	0.26	120	0.2	220	0.2	230
Lights (Includes Shelf Lights)	1.0	120	0.5	220	0.5	230
Condensate Pump	1.0	120	0.5	220	0.5	230

Refer to the rating plate data attached to the rear of the case for Maximum Fuse Size and Minimum Circuit Ampacity.

REPLACEMENT PARTS - MODEL RSSM3078

Part Description	Part #	Part #	Part #
	RSSM3078SC	RSSM3078SC	RSSM3078SC
	120V/60HZ/1	220V/50HZ/1	230V/60HZ/1
Refrigeration System:			
Condensing Unit (Self-Contained Only)	30-20461	30-20837	30-20512
Compressor (Replacement)	30-20679		30-20623
Condenser Fan Motor	32-20968		
Condenser Fan Blade	32-20969		
Condenser Coil	33-20970		
Receiver	32-20971		
Evaporator Coil	33-20658-A	33-20658-A	33-20658-A
Expansion Valve	32-19419	32-19419	32-19419
Evaporator Fan Motor	47-17981	41-19070	41-19070
Evaporator Fan Blade	72-32507	72-32507	72-32507
Filter Drier	32-12626	32-12626	32-12626
Dual Pressure Control	32-51009	32-51009	32-51009
Fan Motor, Blade & Venturi Assembly	41-20864	41-20981	41-20981
Electrical Components:			
Temperature Control (CAREL)	32-19864-1	32-19865-1	32-19865-1
Control Probes (CAREL)	32-19866	32-19866	32-19866
Light, LED-3500K (Cases mfg'd after 2/1/18)	42-20870-23F35	42-20870-23F35	42-20870-23F35
<i>Note: Cases mfg'd before 2/1/18 will require replacement of all (4) LED's to keep consistent light color</i>			
Power Supply Led	39-20555	39-20555	39-20555
Light Switch (On/Off)	41-11066	41-11066	41-11066
Power Switch (On/Off) (Cases mfg'd after 2/1/18)	41-11066	41-18186	41-18186
Heater Wire Assembly	43-14892	43-19467	43-19467
Condensate Pump	47-15686	47-15687	47-15687
Cord & Straight Plug	43-30818		43-17839
Cord & Right Angle Plug	43-20569	43-19448	43-20949
Miscellaneous Components			
Price Tag Molding	W11790	W11790	W11790
Shelf, One Piece w/ 3500K LED Light	SA5779-1A	SA5779-1A	SA5779-1A
<i>Note: Cases mfg'd before 2/1/18 will require replacement of other (3) LED's to keep consistent light color.</i>			
Slanted Deck	M20703	M20703	M20703
Thermometer	32-13662	32-13662	32-13662
Air Deflector (Cases mfg'd before 2/1/18)	15-19336-17	15-19336-17	15-19336-17
Air Deflector (Cases mfg'd after 2/1/18)	15-19222-9	15-19222-9	15-19222-9
White Shelf Lamp Cord	43-20475	43-20475	43-20475
Energy Saving Night Curtain	65-19458	65-19458	65-19458
Caster, Front (Fixed)	65-20581	65-20581	65-20581
Caster, Rear (Swivel)	65-17352	65-17352	65-17352
Filter, Air Condenser Inlet	16-13647	16-13647	16-13647
Glass, End	50-20863-4	50-20863-4	50-20863-4

RSSM3078 DISPLAY AREA AND VOLUME

	RSSM3078
CUBIC FT. PER SHELF	2.2
CUBIC FT. DISPLAY DECK	5.0
TOTAL CUBIC FT.	11.6
SQUARE INCHES PER SHELF	418
SQUARE INCHES DISPLAY DECK	422
TOTAL SQUARE INCHES	1676
SHELF WIDTH "L"	27.25

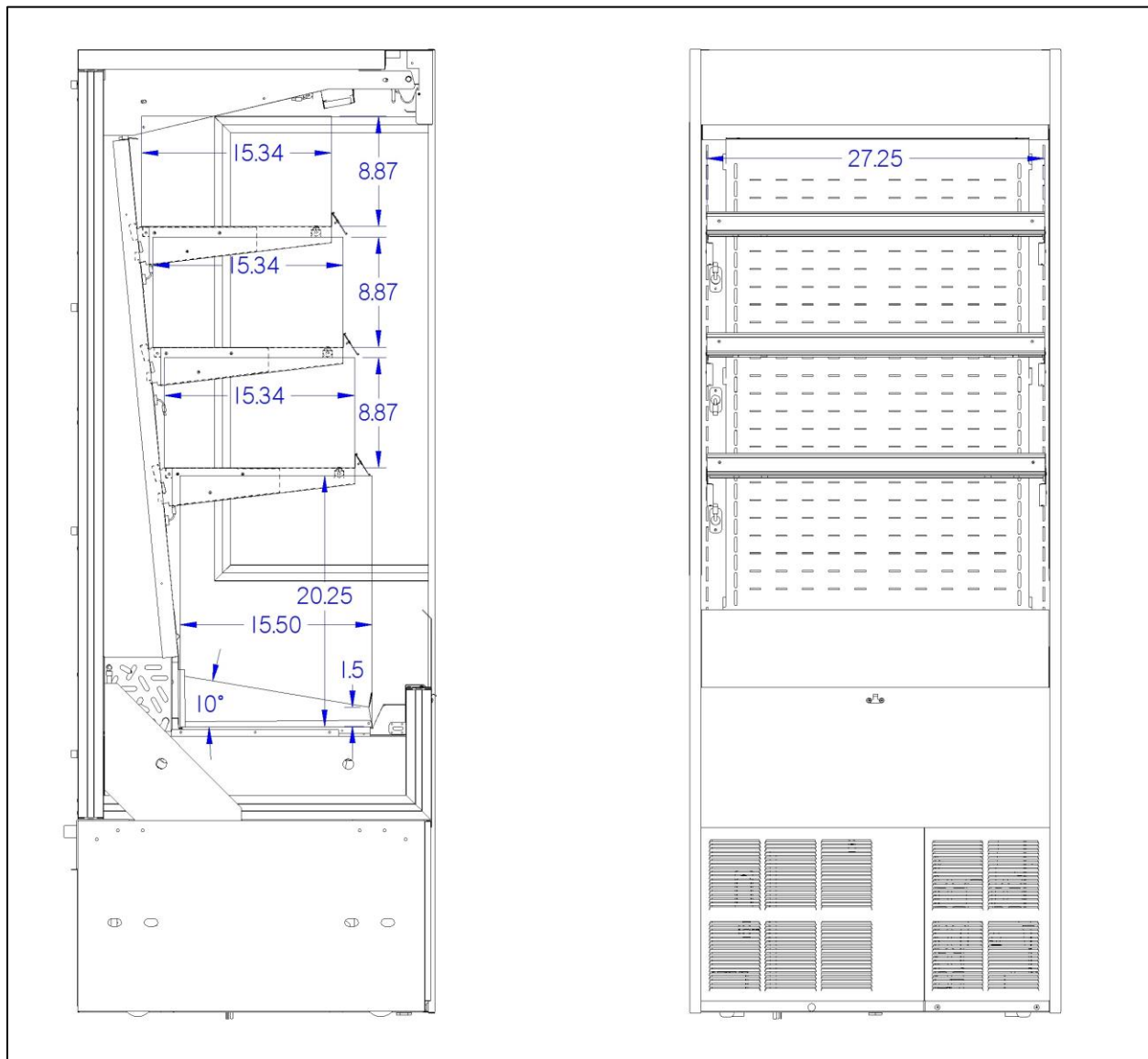

WIRING DIAGRAMS, 120V/60HZ

SELF-CONTAINED RSSM3078SC (MFG'D BEFORE 2/1/18)

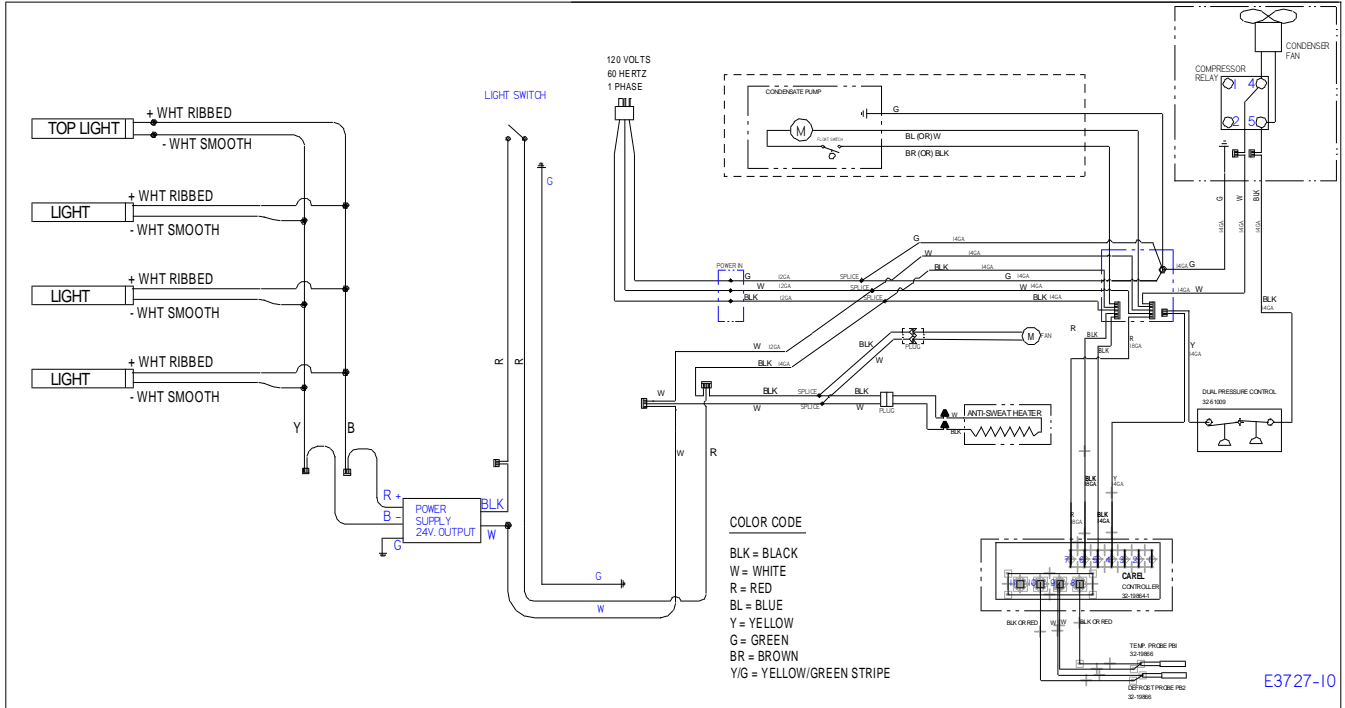

SELF-CONTAINED RSSM3078SC-2 (MFG'D AFTER 2/1/18)

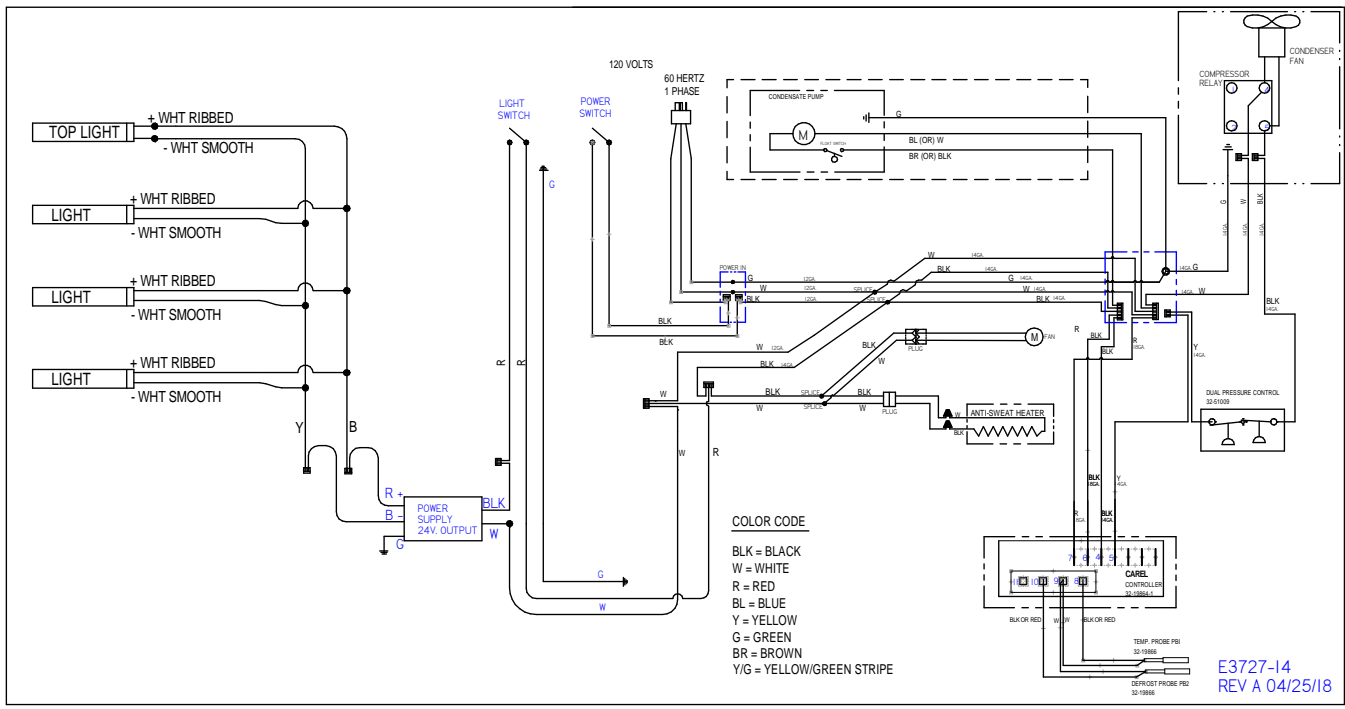

WIRING DIAGRAM, 220V/50 OR 60HZ

SELF-CONTAINED RSSM3078SC (MFG'D BEFORE 2/1/18)

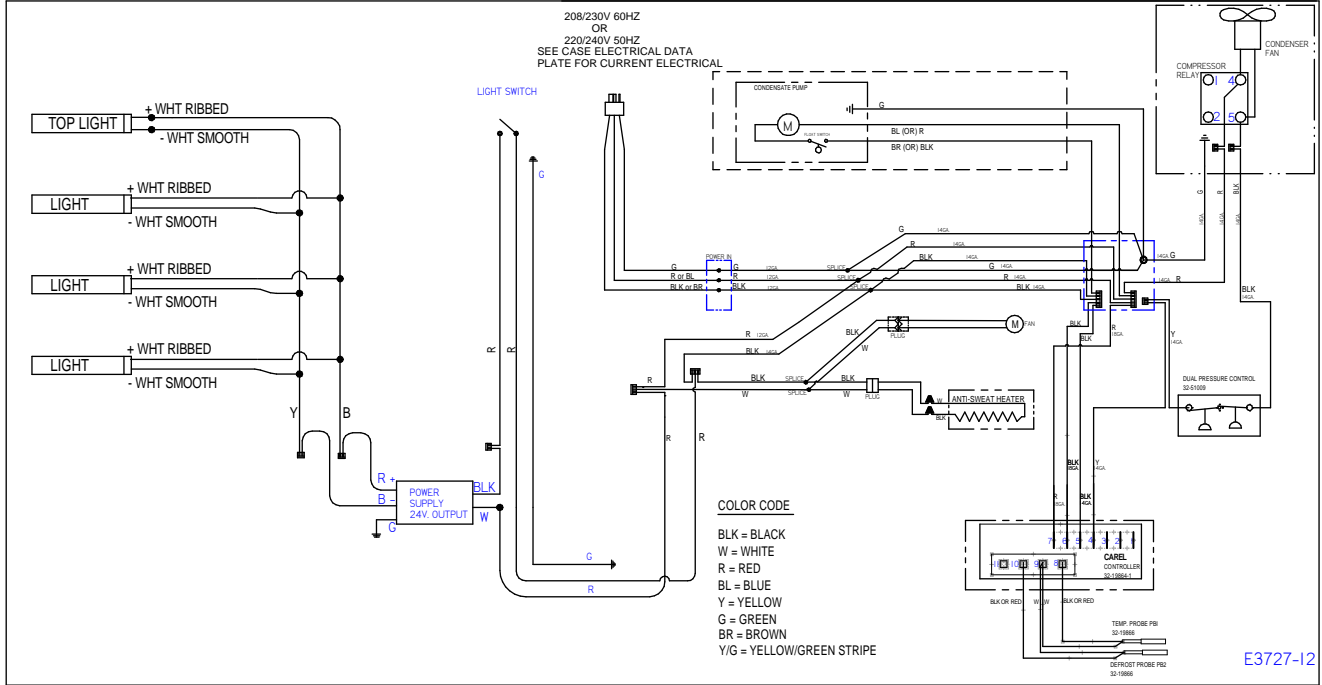

SELF CONTAINED RSSM3078SC-2 (MFG'D AFTER 2/1/18)

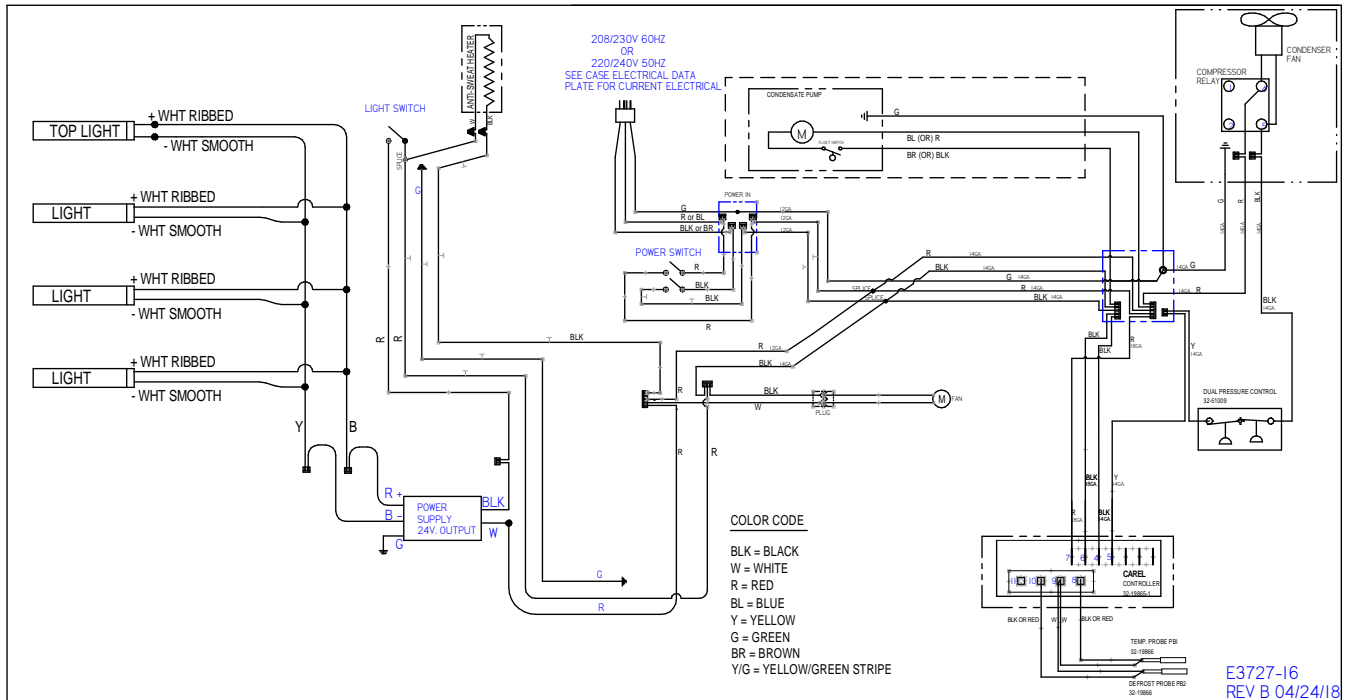

California Residents Only.

 **WARNING**

This product can expose you to chemicals including chromium which is known to the State of California to cause cancer and birth defects or other reproductive harm. For more information go to www.P65Warnings.ca.gov