



Breathe easy.

Technical Manual

**Operation, Maintenance &
Installation
for
Model CG3-UVi Series
Ventilators**

GAYLORD INDUSTRIES

10900 SW Avery Street – Tualatin, Oregon 97062 USA

Email: info@gaylordventilation.com Toll Free 800-547-9696 – Fax 503-692-6048

www.gaylordventilation.com

All rights reserved. No part of this book may be reproduced, stored in a retrieval system, or transmitted in any form by an electronic, mechanical, photocopying, recording means or otherwise without prior written permission of Gaylord Industries.

©Copyright 2014, Gaylord Industries

The manufacturer reserves the right to modify the materials and specifications resulting from a continuing program of product improvement or the availability of new materials



Breathe easy.

Gaylord Industries
10900 SW Avery St.
Tualatin, OR 97062
Office: 503.691.2010
Toll Free: 800.547.9696
www.gaylordventilation.com

To Our Customers:

Congratulations on your recent purchase of a Gaylord Model CG3-UVi Series Ventilator. We are proud to be able to provide you with a quality product that exemplifies our long standing dedication to quality engineering and manufacturing.

Your Gaylord Ventilator is assembled from some of the very finest components available and is designed for years of efficient, effective, and trouble free operation. In addition, the product has undergone rigorous quality control inspections and testing prior to shipment.

If you have any questions, please contact us at info@gaylordventilation.com or by calling us toll free 800-547-9696. We are more than happy to help.

Sincerely,
Gaylord Industries

This Page Intentionally Left Blank

TABLE OF CONTENTS

Chapter 1 – Introduction Page

Introduction	1-1
Model Description	1-2
Model Number Sequence	1-3
Explanation of Damper Options	1-5

Chapter 2 – Principles of Operation

Principle of Operation Overview	2-1
Grease Extraction	2-2
Optional Continuous Cold Water Mist	2-4
Wash Cycle	2-5
Internal Fire Mode	2-8
Fire Extinguishing Systems	2-9

Chapter 3 - Daily Operation

Starting the Exhaust and UV System	3-1
Turning Off the Exhaust Fan and Starting the Wash Cycle	3-5
Recommend Detergent	3-8

Chapter 4 – Maintenance

Operator Preventive Maintenance	4-1
Preventive Maintenance Required by Code	4-2
UV System - Scheduled Preventive Maintenance	4-3

Chapter 5 - Troubleshooting

Troubleshooting	5-1
-----------------------	-----

Chapter 6 – Testing and Repair

Measuring Airflow	6-1
Make-Up Air Guidelines	6-5
Replacing UV Lamps	6-7
Replacing UV Lamp Sockets	6-13
Replacing UV Ballast	6-19
Main Electrical Raceway Ventilation Fan	6-30
UV Module Ventilation Fans	6-32
High Temperature Shutdown Controller	6-36
Safety Interlock Pressure Switch	6-37
UV Ventilation Control Board	6-37
Replacing UV Module Access Door Gasket	6-40
Replacing UV Module Plate Gasket	6-41
Damper Motor	6-42

Chapter 7 - Parts

Parts - Ventilator	7-1
Parts - UV Lamp Module	7-4
Parts – Main Electrical Raceway	7-5
Parts – Miscellaneous	7-7

Chapter 8 – Wiring Diagrams

Wiring Diagrams	8-1
-----------------------	-----

Appendices

Sample Ventilator Nameplate A-1
Installation Requirements B-1
Ventilator Start-Up Inspection and Tests – Overview C-1
Pre Start-Up Check List C-1
Start-Up Inspection and Tests Report Forms C-3
Limited Warranty Inside Back Cover

About this Technical Manual

The purpose of this manual is to provide the Operator, Maintenance and Service personnel instructions for operating, maintaining, troubleshooting and repairing the Gaylord Ventilator Model CG3-UVi Series. Ventilators incorporating UV Systems, most maintenance and all repairs must be performed by a trained and certified service company. This manual also includes information and guidance to contractors for initial installation of the Ventilator.

The manual is divided into chapters for easy reference to a particular subject. The pages in the chapters are numbered with the chapter number, then a dash, and then the page number. So for example pages in Chapter 2 are numbered 2-1, 2-2, 2-3 etc. Figures and Tables are numbered in a similar manor. For example Figure 5-3-2 is on page 5-3 and is the second figure. Please keep your manual in a convenient location for so it can be accessed easily.

If you have any questions or concerns with the installation, operation, maintenance or service of your Gaylord Ventilator, please contact Gaylord Industries;

Web: www.gaylordventilation.com

E-Mail: info@gaylordventilation.com

Main Phone: 503-691-2010

Toll Free: 800-547-9696

Safety

It is important that the operator read Chapter 2, Principle of Operation, and Chapter 3, Maintenance, before operating the Ventilator for the first time. Particular attention should be given to all the **Caution** and **Warning** statements.

Related Technical Manuals

CG3-UVi Series Ventilators are controlled by a Gaylord Command Center. The model number of the Command Center is dictated by when the Ventilator was purchased. Typical models are C-6000 and C-7000 Series. The model number of your Command Center can be found on the nameplate located on the back of the electrical compartment door. **All Installation Operation and Maintenance Manuals may be downloaded from the Gaylord website: www.gaylordventilation.com or be obtained by calling Gaylord Industries.**

Model Description Overview

The Gaylord Model CG3-UVi Series Ventilator is a high grease extraction efficiency Ventilator that includes the additional feature of an Ultraviolet Light System that dramatically reduces grease accumulation in the exhaust plenum, ductwork and exhaust fans. The Ventilator incorporates a hot water Wash Cycle that automatically washes the accumulated grease and particles out of the Ventilator and into the building drain system.

The CG3-UVi Ventilators come in many different models, Wall Mounted Canopy, Single Island Style, and Double Island Style. All Gaylord Ventilators are custom designed to fit the space and application of your facility.

Model Number Sequence

The CG3-UVi Series model numbers are made up of an alphabetic prefix followed by a series of alphabetic and/or numeric suffixes to designate the style of ventilator and various options. Sequence of model numbers is as follows.

1. _____	2. _____	3. _____	4. _____	5. _____	6. _____	7. _____	8. _____	9. _____
<i>Series</i>	<i>Damper Type</i>	<i>Style</i>	<i>Low Profile Design (Option)</i>	<i>Style of Built in Make-up Air If Applicable</i>	<i>Custom Air If Applicable</i>	<i>Cold Water Mist, If Applicable</i>	<i>Autostart If Applicable</i>	<i>Front to Back Dimension of the Ventilator in Inches</i>

Explanation of Prefixes and Suffixes

1. Series

CG3-UVi Water Wash Ventilator with ultraviolet light feature.

2. Damper Type

Blank Space Electrically activated three position damper located at air inlet slot (Refer to Figure 1-5-1).

FDD Same as CG3-UVi except inlet damper is fixed and has a fuse link activated fire damper located at the duct collar (Refer to Figure 1-6-1)

FDT Inlet damper is fixed and no damper motor, and has fuse link activated fire damper located at the duct collar with a thermostat to detect fire to send notification (Refer to Figure 1-5-3)

FDL Same as CG3-UVi except a bracket (Fire Damper Lockout) has been added to prevent the damper from closing to the fire position (Refer to Figure 1-5-2)

ND Same as CG3-UVi except inlet damper is fixed and has no fire damper (Refer to Figure 1-6-2).

3. Style

BDL Wall mounted canopy.

BDL-BB Island style for back-to-back cooking equipment using two extraction chambers and two separate exhaust ducts.

BBC Island style for back-to-back cooking equipment using two extraction chambers with one common exhaust duct.

BDL-DS Island style for back-to-back cooking equipment using one extraction chamber with two inlet slots. Has common exhaust duct.

BDL-DS-CL Island style for single line of cooking equipment.

4. Profile

LP Low Profile. Reduced height of front face of Ventilator and sloping end panels.

Definition of Prefixes and Suffixes – Cont.

5. Style of Built In Make-Up Air (If Applicable)

- MAW** Front face make-up air using perforated stainless steel panels.
- MAR** Front face make-up air using registers or grills.
- MAI** Internal short circuit make-up air.
- MAW/MAI** Combination of MAW and MAI design.
- MAR/MAI** Combination of MAR and MAI Design.

6. Custom Air (If Applicable)

- CA** Additional baffles added to reduce the air volume over specific types of cooking equipment.

7. Cold Water Mist (If Applicable)

- CM** Addition of cold water manifold with spray nozzles at the air entry slot for application over solid fuel burning cooking appliances (Refer to Figure 2-4-1).

7. Autostart Option

- Blank Space** Indicates the hood section does not have Autostart system as required by IMC.
- AS** Indicates the hood section has Autostart conforming with the IMC requirement.

8. Front to Back Dimension

- In Inches** Indicates front to back dimension of the Ventilator, or the overall width of an island style.

Explanation of Damper Options

1. **CG3-UVi Ventilator** – This is the standard Ventilator and incorporates a damper at the air inlet slot that during a wash mode closes forward by an electric motor to seal off the inlet slot and opens to the exhaust position when the exhaust fan is started. During a fire mode, that is activated by a thermostat the damper closes backwards to the fire position and stays closed until the thermostat drops below its set point and then closes to the wash position.

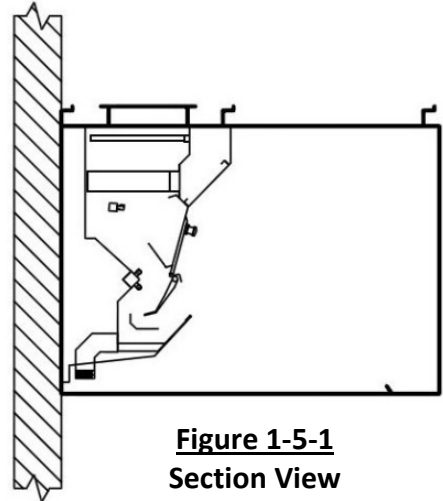

Figure 1-5-1
Section View
CG3-UVi

2. **CG3-UVi-FDL Series** – The FDL in the model number stands for Fire Damper Lockout. This Ventilator incorporates the same inlet damper as the CG3-UVi that during a wash mode closes forward by an electric motor to seal off the inlet slot and opens to the exhaust position when the exhaust fan is started. The main difference is the CG3-UVi-FDL has a Fire Damper Lockout (FDL) bracket added that prevents the inlet damper from closing to the fire position, so it does NOT have a fire damper. This Ventilator does include a thermostat to send a signal to fire alarm systems.

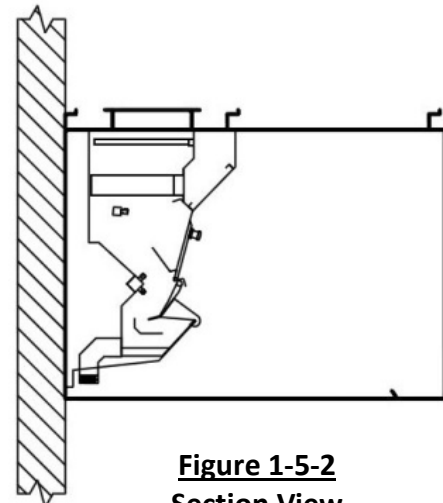

Figure 1-5-2
Section View
CG3-UVi-FDL

3. **CG3-UVi-FDT Series** – The FDT in the model number stands for a fuse link Fire damper in the Duct collar with a Thermostat. The fire damper is weighted and when the fuse link reaches its melting point, the damper closes. The thermostat sends a signal to the fire alarm systems.

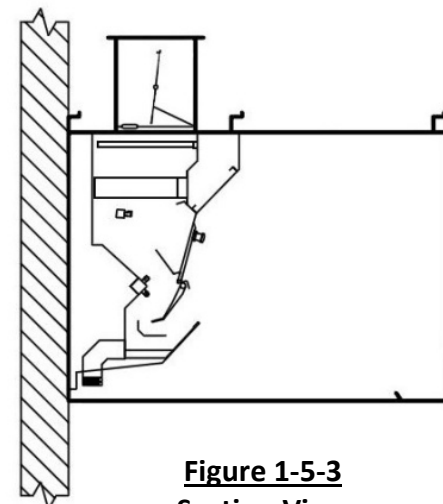

Figure 1-5-3
Section View
CG3-UVi-FDT

Explanation of Damper Options – Cont.

4. **CG3-UVi-FDD Series** – The FDD in the model number stands for Fire Damper in the Duct collar. The fire damper is weighted and when the fuse link reaches its melting point, the damper closes. There is no thermostat.

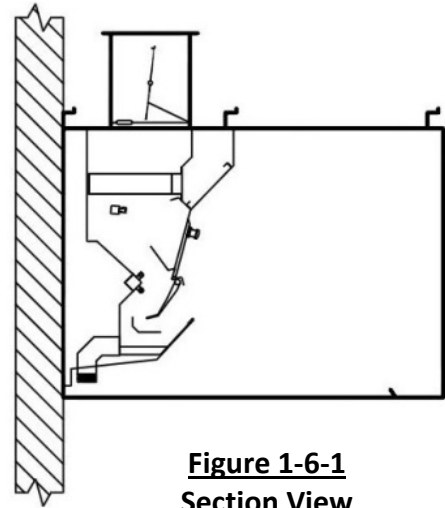

Figure 1-6-1
Section View
CG3-UVi-FDD

5. **CG3-UVi-ND Series** – The ND in the model number stands for No Damper.

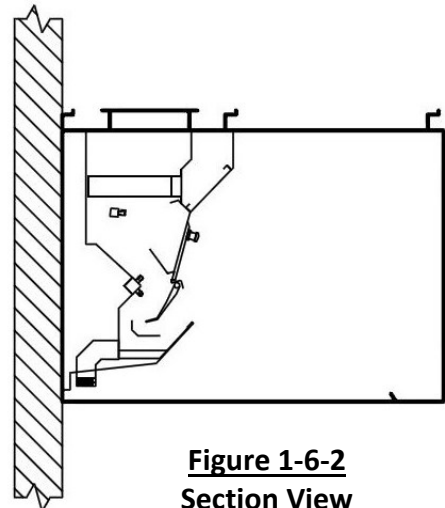

Figure 1-6-2
Section View
CG3-UVi-ND

Principle of Operation Overview

The Gaylord Model CG3-UVi Series Ventilator is a high grease extraction efficiency Ventilator that includes the additional feature of an Ultraviolet Light System that dramatically reduces grease accumulation in the exhaust plenum, ductwork and exhaust fans. The Ventilator incorporates a hot water Wash Cycle that automatically washes the accumulated grease and other particles out of the Ventilator and into the building drain system. The standard CG3-UVi Ventilator has a full length fire damper located at the air inlet slot, two models have a fire damper in the exhaust duct collar and one model does not have a fire damper.

The operation of the exhaust fan and the Wash Cycle is controlled by the Gaylord Command Center which is located on the face of the Wash Control Cabinet (Refer to Figure 2-1-1). All the plumbing components, detergent pump and detergent tank are located inside the Wash Control Cabinet (Refer to Figure 2-1-2 and Figure 2-7-2).



Figure 2-1-1
Typical Command Center



Figure 2-1-2
Typical Wash Control Cabinet

Grease Extraction

Overview

The Gaylord "CG3-UVi" Series Ventilator extracts up to 95% of the grease, dust and lint particles from the airstream passing through it, when operated and maintained in accordance with design specifications. This high rate of grease extraction is accomplished by the use of grease extraction baffles, particulate separators and UV lamps. The following describes the function of each.

Grease Extraction Baffles

When the exhaust fan is started the hot, grease-laden air rising from the cooking surface merges with the higher velocity air that wipes the front of the cooking equipment and extends, like an air blanket, from the front edge of the cooking equipment to the air inlet slot of the Ventilator. As the air moves through the Ventilator's extraction chamber at a high speed, it is forced to make a series of turns around three baffles. As this high velocity air turns around each baffle, the larger particles of grease are thrown out of the airstream by centrifugal force and collected on the baffles. The extracted grease, dust and lint are collected in the interior of the ventilator, remaining out of the airstream until removed daily by the wash cycle.

Baffle #1

Important Note: The following description of Baffle #1 is for the standard CG3-UVi series Ventilator. For operation of Baffle #1 for series FDL, FDT, FDD, and ND refer to Table T-2-9-1).

This baffle, located at the air entrance of the ventilator, is a three position damper. Position 1 is the exhaust on mode as shown in Figure 2-3-1, position 2 is the wash mode as shown in Figure 2-6-1, and position 3 is the fire mode as shown in Figure 2-8-1. When the "**START FAN**" button is pushed on the Command Center, the damper opens to the exhaust mode position 1 to become the preliminary grease extraction baffle. There is a small sloped grease collecting gutter on the back side of the damper which drains off liquefied grease, preventing it from re-entraining into the airstream.

Baffle #2

This baffle is located on the interior back wall of the ventilator and is a stainless steel pipe, equipped with brass spray nozzles on 8" to 10" centers (Refer to Figure 2-3-1). During the wash cycle, hot detergent water is released through the nozzles.

Baffle #3

This baffle is located on the back of the inspection doors (Refer to Figure 2-3-1). This baffle is also a grease collecting gutter, collecting the grease extracted by the ventilator preventing the contaminants from dropping back into the high velocity airstream.

Optional Custom Air Baffles

Some Ventilators may be equipped with optional Custom Air baffles, shown dotted, which reduces the exhaust volume where the baffles occur (Refer to Figure 2-3-1).

Particulate Separator

Once the larger particles of grease have been captured through inertial impaction by the baffles, the smaller particles will be arrested in the Particulate Separator using the principles of diffusion and inertial impaction (Refer to Figure 2-3-1). These collected particles will be washed away each day by the automatic wash.

Grease Extraction – Cont.

UV Lamps

Once the baffles and particulate separator have collected the grease particles larger than 1 micron, the UV lamps will break down the remaining grease particles by direct exposure to 254nm light and by the Ozone, Hydroxyl Radicals and Anionic oxygen created by the 187nm UV light and oxidizing the grease into a light gray dust. The Ozone will carry down the ductwork and continue to break down the grease particulate and odor molecules keeping the ductwork much cleaner. The byproducts of this process are CO₂, H₂O and the base minerals from the grease and particulate matter coming off of the cooking surface. The light gray dust that collects on the lamps is washed away each day during the Wash Cycle. UV Systems are used to remove a high percentage of grease that the baffles and particulate separator cannot remove, offering many benefits to the owner/operator.

The UV Lamps are mounted in an UVi Module which slide into a track downstream of the Particulate Separator (refer to Figure 2-3-1). The ballasts are mounted in the front portion of the module and other electronics are mounted in the electrical raceway (Refer to Figure 6-7-1 and 6-15-1). The Command Center monitors and displays text indicating the status of the UV System, and Safety Interlocks. Refer to your Command Center Tech Manual for specific text displayed.

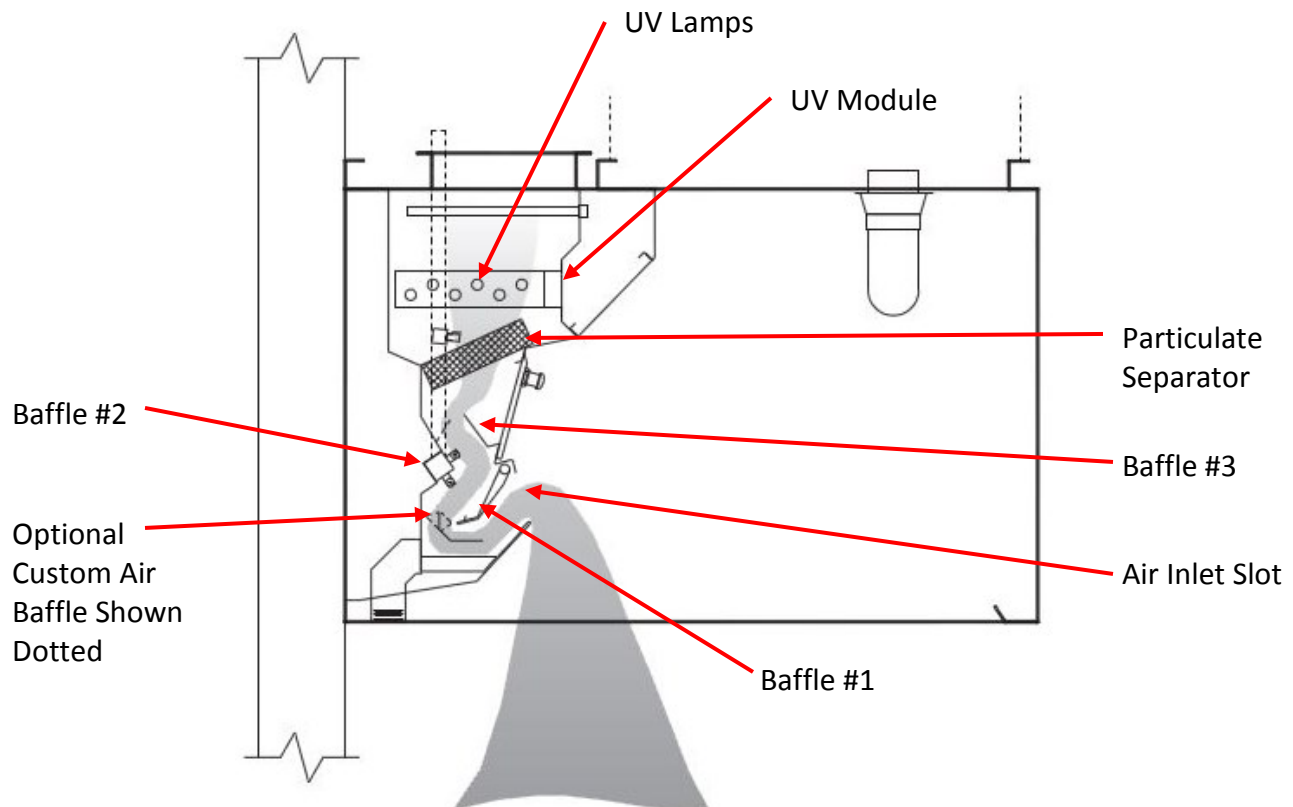

Figure 2-3-1
Grease Extraction Mode

Grease Extraction – Cont.

UV Lamps – Cont.

For proper UV operation, the Ventilators must be maintained in good working order. The UV system must be inspected periodically and the lamps replaced as necessary. The Ventilator, ductwork and exhaust fan must be inspected in accordance with NFPA-96 or local guidelines, though frequency of duct cleanings should be significantly reduced. Refer to Chapter 4 for maintenance details.

UV Safety

Caution: Exposure to UV light is harmful to skin and eyes.

The CG3-UVi Series Ventilator is equipped with panels and Safety Interlocks to protect operators from direct exposure to UV light. All safety precautions called for in this manual must be followed to avoid the potential for harm to operators or service personnel. Refer to Page 4-3 for complete description of safety precautions.

Optional Continuous Cold Water Mist

Overview

Some ventilators may be equipped with optional continuous cold water mist. NFPA-96 requires that all hoods used over solid fuel burning appliances be equipped with a “spark arrester” to knock down any embers, created by the burning of solid fuel, to reduce the possibility of embers or sparks being drawn up into the exhaust duct and fan where it could ignite collected grease. Continuous cold water mist is one of the acceptable spark arresters.

Continuous cold water mist ventilators incorporate a water manifold with spray nozzles, located at the lower edge of the air inlet slot (Refer to Figure 2-4-1). When the exhaust fan is started, the solenoid valve in the cold water loop in the Wash Control Cabinet opens (Refer to Figure 2-5-1), turning on the mist nozzles which remain on as long as the exhaust fan is on. The nozzles produce a very fine mist and are located so that the entire air stream passes through the mist.

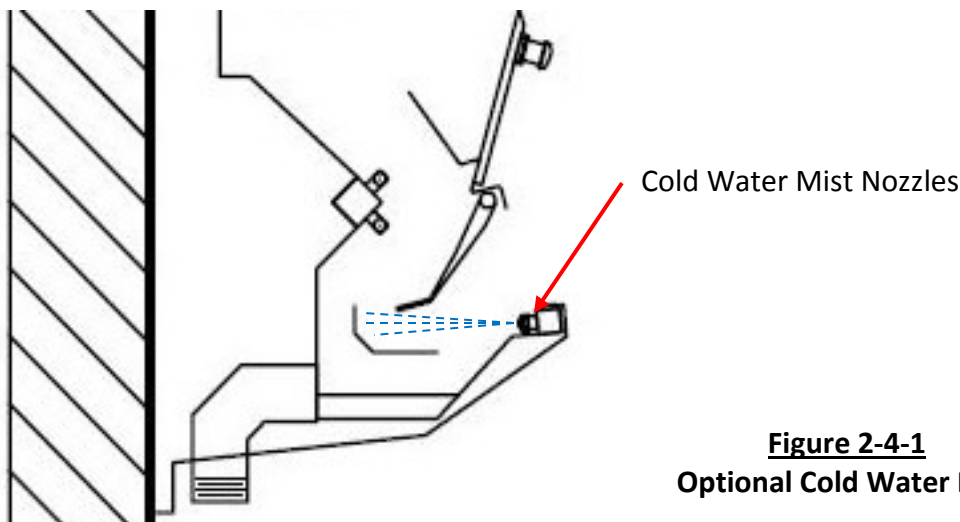

Figure 2-4-1
Optional Cold Water Mist

Optional Continuous Cold Water Mist – Cont.

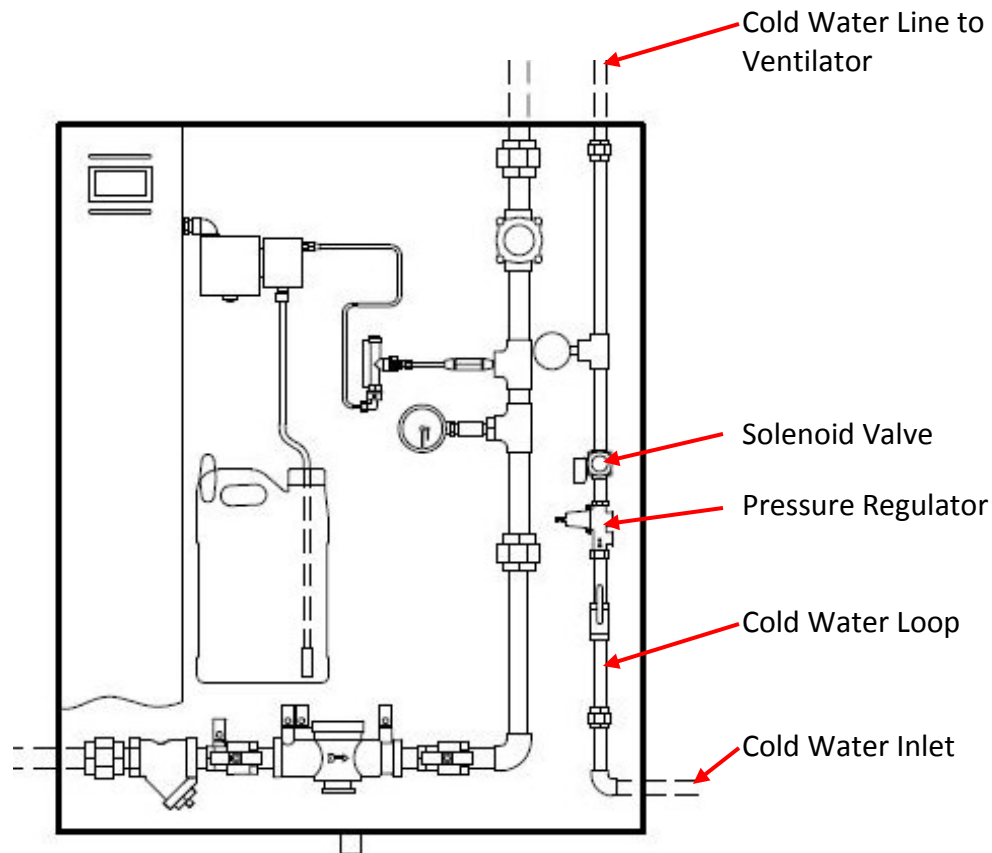

Figure 2-5-1
Typical Wash Control Cabinet
With Continuous Cold Water Mist Loop

Engineering Notes

1. Water pressure: The optimal water flow pressure of the nozzle is 40 psi. There is a pressure regulator and pressure gauge in the plumbing loop to accomplish this pressure.
2. Water Consumption: .66 GPH per lineal ft. of Ventilator at 40 psi.

Wash Cycle

The wash system is comprised of two wash manifolds with spray nozzles are located on 8" to 10" centers (Refer to Figure 2-6-1). The wash cycle is activated each time the exhaust fan is shut off by pushing the **START WASH** button on the Command Center or automatically at a specific time as programmed in the Command Center (Refer to Figure 2-7-1). When activated the UV lamps shut off, the exhaust and supply fans shut off, the electric damper motor is energized and the damper begins closing forward to the wash position, and once closed the hot water wash sprays come on (Refer to Figure 2-6-1).

Wash Cycle – Cont.

The detergent pump, detergent tank, solenoid valve and other plumbing components are located in the Wash Control Cabinet (Refer to Figure 2-7-1). This hot detergent water washes the day's grease, dust and lint accumulation from the baffles, the Particulate Separator, and gray dust from the UV Lamps, flushing it down to the main gutter which slopes to a pre-flushed drain which leads to the building drain system. At the end of the wash cycle, the water automatically shuts off, and the interior of the Ventilator is clean and ready for the next day's operations. The damper remains in the wash position until the exhaust fan is restarted. This is to prevent conditioned air from going up the exhaust system during off hours.

The length of the wash cycle may be set between 3 minutes and 9 minutes. The length of time is dependent upon the type of cooking equipment being used. Typical settings are 3 minutes for light-duty equipment, 5 minutes for medium-duty equipment, and 9 minutes for heavy-duty equipment. However, adequate cleaning is dependent upon water pressure, water temperature, daily grease accumulation, the length of the wash cycle, frequency of wash cycle and the type of detergent being used. It may be necessary to increase the wash time to achieve proper cleaning. Refer to your Command Center Technical Manual for instructions on programming wash times.

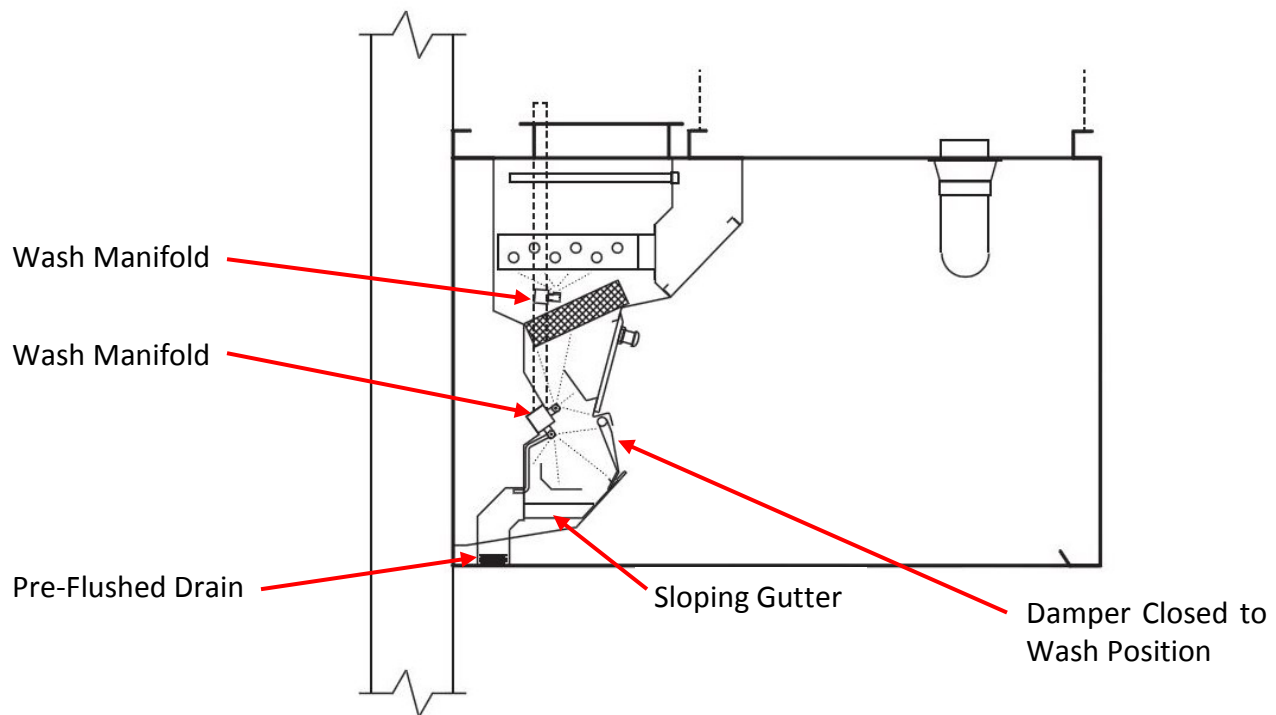

Figure 2-6-1
Wash Mode

Engineering Notes

1. Hot Water Pressure: 40 PSI Min. – 80 PSI Max.
2. Hot Water Temperature: 140° Min. - 180° Max.
3. Water Consumption: 1.14 GPM/ lineal ft. of Ventilator at 40 PSI Average
1.67 GPM/ lineal ft. of Ventilator at 80 PSI Average

Wash Cycle – Cont.



Figure 2-7-1
Command Center

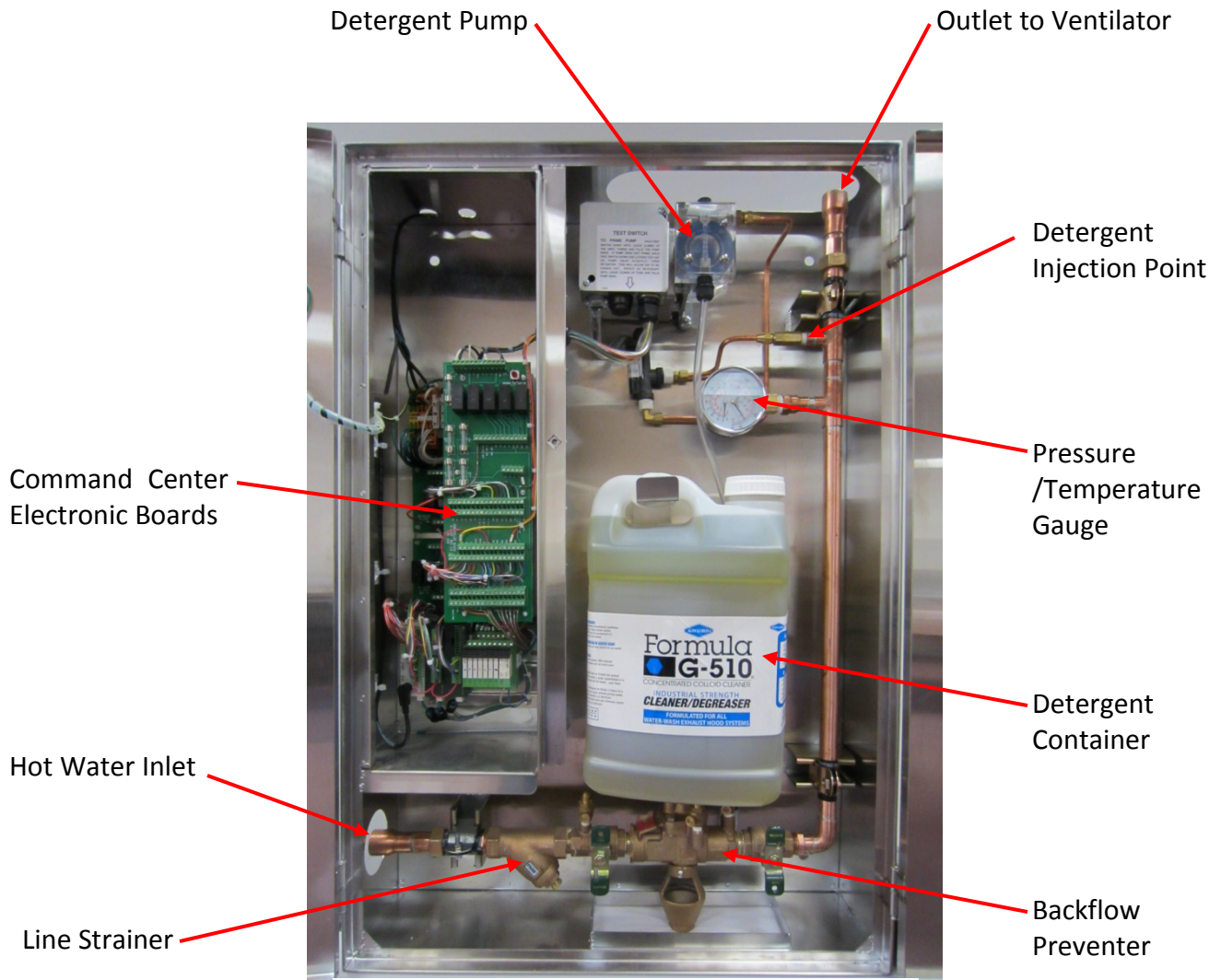

Figure 2-7-2
Typical Wash Control Cabinet With Electrical and Plumbing Doors Open

Internal Fire Mode

Important Note: The following description of the Internal Fire Mode is for the standard CG3-UVi series Ventilator only. Refer to Table T-2-9-1 for a description of the Internal Fire Mode for series FDL, FDT, FDD, and ND.

Automatic internal fire protection is accomplished by the action of the thermostat(s), which are located at the point where the ductwork joins the ventilator (Refer to Figure 2-8-1). When the temperature of the conveying airstream, which must pass over the thermostats, reaches 250°F, the system is activated, and the following occurs:

1. Baffle #1 begins closing back to the fire position, position #3, stopping the combustion supporting natural draft through the ventilator and creating a fire barrier to contain the fire in the kitchen (Refer to Figure 2-8-1).
2. The UV lamps shut off.
3. The exhaust fan serving the ventilator is shut off. The supply fan is also shut off.
4. A fire signal is sent from the Command Center to the build fire alarm system (if wired).
5. The display on the Command Center will indicate a fire. **Important Note:** Refer to your Command Center Technical Manual for specific text displayed during a Fire Mode.
6. Upon cooling of the thermostat below 250°F, a 2 minute Cool Down Cycle begins and Baffle #1 moves to the exhaust position. **Important Note:** Refer to your Command Center Technical Manual for specific text displayed during a Cool Down Cycle.
7. At the end of the Cool Down Cycle the damper closes to the wash position. **Important Note:** Refer to your Command Center Tech Manual for specific text displayed upon completion of a Cool Down Cycle.
8. The exhaust fan can now be restarted.

Important Note: The water sprays do not come on during a Fire Mode

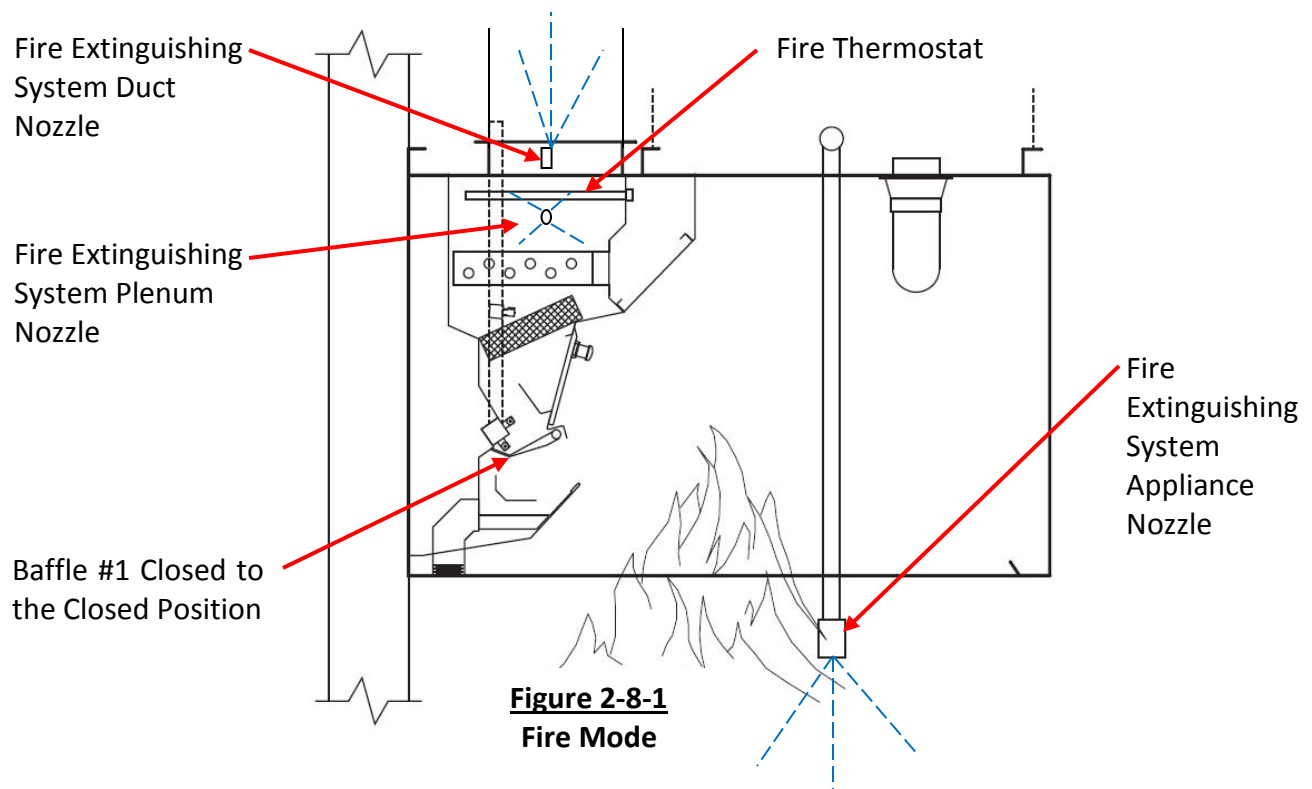

Internal Fire Mode – Cont.

Table T-2-9-1

Internal Fire Mode (Thermostat Activated)			
Series	Baffle #1	Duct Collar Damper	Signal sent to building fire alarm system (if wired)
CG3-UVi	Closes to Fire Position	None	Yes
CG3-UVi-FDL	Baffle Fixed	None	Yes
CG3-UVi-FDT	Baffle Fixed	Closes if fuse link reaches activation temp	Yes
CG3-UVi-FDD	Baffle Fixed	Closes if fuse link reaches activation temp	No Thermostat
CG3-UVi-ND	Baffle Fixed	None	No Thermostat

Fire Extinguishing Systems

The National Fire Protection Association Standard 96 (NFPA-96) and the International Fire Code (IFC) requires the use of a Fire Extinguishing System to cover the cooking surfaces, Ventilator exhaust plenums (the area behind the grease extractors), and the exhaust duct (Refer to Figure 2-8-1). Upon activation of the Fire Extinguishing System the follow will occur:

1. Fire extinguishing agent will discharge through the cooking equipment nozzles, the plenum nozzles and the duct nozzle(s).
2. The protected cooking equipment and possibly other cooking equipment will shut off. Refer to the above referenced codes for specific equipment that must shut off.
3. If the Fire Extinguishing System is wired to a building fire alarm system the alarm will activate.
4. If the Fire Extinguishing System is wired to a building management system it will notify of a fire condition.
5. The Fire Extinguishing System should be wired to the Gaylord Command Center. If wired the following will occur:
 - a) If the exhaust and supply fan were on the exhaust fan would stay on and the supply fan would shut off. If the exhaust and supply fans were off, the exhaust fan would come on and the supply fan would stay off.
 - b) If the Ventilator Wash Cycle was on it would shut off.
6. After discharge, the Fire Extinguishing System must be recharged and certified by a fire system contractor before the cooking equipment can be turned back on.

For Operation and Maintenance of the Fire Extinguishing System, refer to the system manufacture's Owner's Manual.

Important: NFPA-96 requires inspection and certification of Fire Extinguishing Systems every 6 months.

This Page Intentionally Left Blank

Starting the Exhaust Fan and UV System

Caution: Exposure to UV light is harmful to skin and eyes.

The CG3-UVi Ventilator is equipped with panels and Safety Interlocks to protect operators from direct exposure to UV light. All safety precautions called for in this manual must be followed to avoid the potential for harm to operators or service personnel. Refer to Page 4-3 for complete description of safety precautions.

Caution: Always turn on the exhaust fan before turning on the cooking equipment.

Caution: The chemical fire extinguishing system may discharge if the exhaust fan is not on while the cooking equipment is on or still hot.

Caution: Never operate the Ventilator with the UV Module Access Doors or the Extractor Inspection Doors open (Refer to Figure 2-3-1).

Operation of the exhaust fan and UV Lamps is controlled by the Gaylord Command Center located on the Wash Control Cabinet (Refer to Figure 3-2-1). To start the exhaust fan and turn on the UV Lamps push the **START FAN** button on the Command Center. The Command Center may be programmed to automatically start the exhaust fan at a specific time. Refer to the Technical Manual for your specific Gaylord Command Center for complete operating instructions of the Command Center.

When the **START FAN** button is pushed the following occurs:

1. Baffle #1 begins opening from the wash position to the exhaust position (Refer to Figure 2-6-1 and 3-2-3). **Note:** Baffle #1 only opens on Models CG3-UVi and CG3-UVi-FDL Series. Baffle #1 is fixed on Models CG3-UVi-FDT, CG3-UVi-FDD and CG3-UVi-ND Series. The Ventilator model number can be found on the Ventilator Nameplate (Refer to Appendix "A" for a sample of the Nameplate). Refer to page 1-3 for a complete explanation of model numbers.
Important Note: Refer to your Command Center Technical Manual for specific text displayed while the baffle #1 is opening.
2. The supply fan comes on.
3. After baffle #1 fully opens (elapsed time approximately 45 seconds), the exhaust fan comes on (Refer to Figure 3-3-1). **Important Note:** Refer to your Command Center Technical Manual for specific text displayed after baffle #1 opens.
4. Once the exhaust fan reaches operating speed, the UV lamps will come on and the green UV Status Light on each Ventilator section will come on (Refer to Figure 3-4-1). The Ventilator is now in the operational exhaust mode. **Important Note:** Refer to your Command Center Technical Manual for specific text displayed when the Ventilator is in the operational exhaust mode.

Starting the Exhaust Fan and UVi System – Cont.



Figure 3-2-1
Typical Command Center



Figure 3-2-2
Typical Wash Control Cabinet

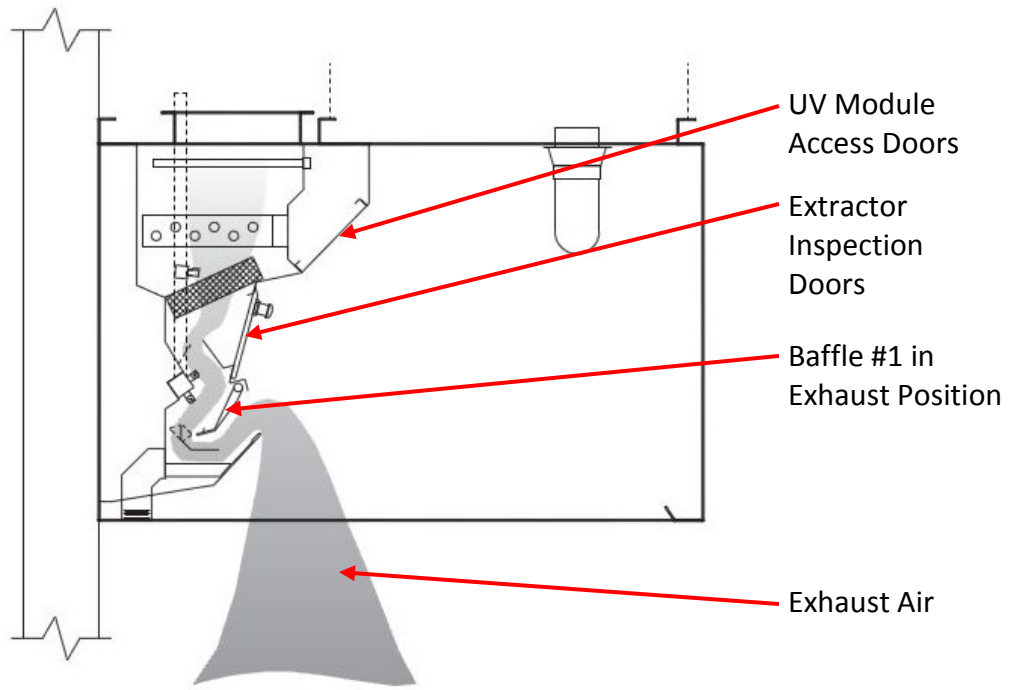

Figure 3-2-3
Exhaust Mode

Starting the Exhaust Fan and UVi System – Cont.

Note 1: Typically CG3-UVi Series Ventilators installed in the United States are equipped with a Gaylord Autostart Controller that automatically turns on the exhaust fan if the temperature at the sensors mounted in the canopy exceeds 90°F. (Refer to Figure 3-3-1). In some instances Ventilators installed outside the United States will include an Autostart Control. Inclusion of an Autostart Control is designated by the suffix “AS” in the model number. The Ventilator model number can be found on the Ventilator Nameplate (Refer to Appendix “A” for a sample of the Nameplate). Refer to your Command Center Technical Manual for complete information on the Autostart Control.

Note 2: The UV Lamps will not come on unless all the Extractor Inspection Doors and UV Module Access Doors are closed as shown in Figure 3-2-3.

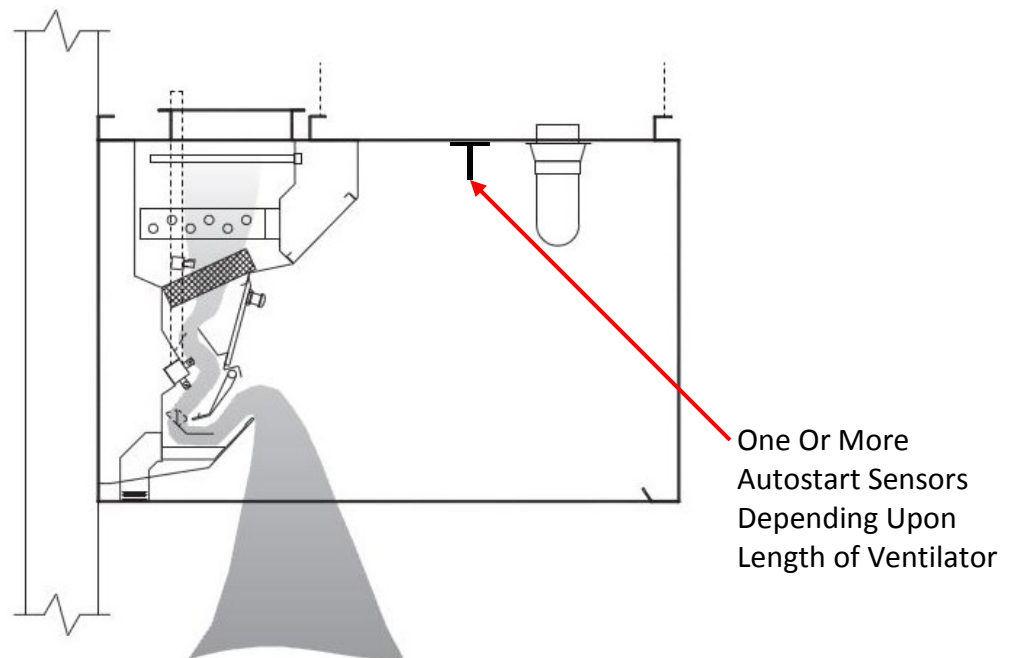

Figure 3-3-1
Ventilator Showing Autostart Sensor

UV Status Lights

Each Ventilator section contains a bank of UV Status Lights to monitor the UV System (Refer to Figure 3-4-1). There are three colored lights, Green, Yellow and Blue. They indicate the system status as follows:

1. Green On: The UV system is operating properly.
2. Yellow On: One or more UV Lamps are not operating. If the yellow is on, less UV is being generated; however it does not prevent the operation of the Ventilator or indicate an unsafe condition.
3. Blue On: One or more Extractors Inspection Doors or UV Module Access Doors are not closed or latched properly. During this condition the UV System is not operating.

Starting the Exhaust Fan and UVi System – Cont.

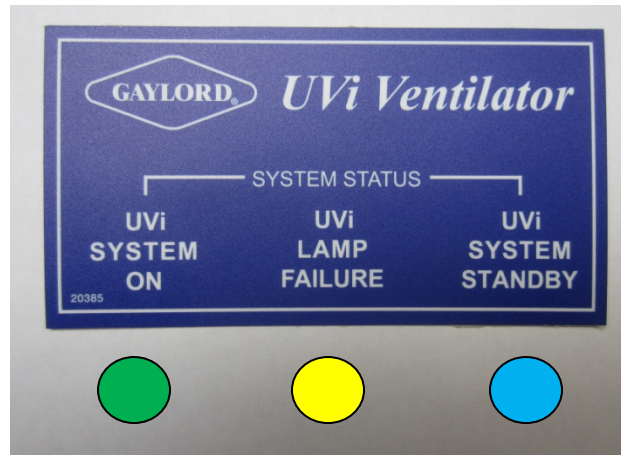

Figure 3-4-1
UVi Status Lights

In addition to the Status Lights on the Ventilator, the Gaylord Command Center displays text indicating the similar message as the Status Lights. Refer to your Command Center Technical Manual for specific text displayed.

Note: If either the Yellow or Red light are on refer the Troubleshooting section of this manual beginning on page 5-1 for corrective action.

Important Note:

The Command Center illustrated in this manual may not represent the model of Command Center you have. Refer to the Technical Manual for your specific model of Command Center for complete instructions on programming wash times. If you do not have a Technical Manual for your Command Center, obtain the model number from the nameplate on the Command Center and contact Gaylord Industries. Refer to page 1-1 for contact information.

Turning Off the Exhaust Fan and Starting the Wash Cycle

Caution: Always turn off the cooking equipment and allow to cool before turning off the exhaust fan. The chemical fire extinguishing system may discharge if the cooking equipment is on or hot when the exhaust fan is off.

To turn off the exhaust fan and UV Lamps and start the Wash Cycle push the **START WASH** button on the Gaylord Command Center (Refer to Figure 3-2-1). If the Command Center is programmed to stop the fan automatically, then the stop button does not need to be pushed.

When the **START WASH** button is pushed the following occurs:

1. The exhaust and supply fans shut off.
2. The UV lamps shut off and the green UV System Status Light will shut off.
3. Baffle #1 begins closing forward to the wash position (Refer to Figure 3-6-1). This action takes approximately 45 seconds. **Note:** Baffle #1 only move to the wash position on Models CG3-UVi and CG3-UVi-FDL Series. Baffle #1 is fixed on Models CG3-UVi-FDT, CG3-UVi-FDD and CG3-UVi-ND. Refer to pages 1-5 and 1-6 for complete explanation. **Important Note:** Refer to your Command Center Technical Manual for specific text displayed while the baffle #1 is moving to the wash position.
4. After baffle #1 closes to the wash position, the Wash Cycle comes on spraying hot, detergent injected water, through the spray nozzles washing away the day's grease, dust and lint accumulation from the baffles, the particulate separator, and gray dust from the UV Module, flushing it down to the main gutter which slopes to drain that leads to the building drain system (Refer to Figure 3-6-1). The Wash Cycle stays on for the length of time programmed in the Command Center. The typical wash times are 3 minutes for light-duty equipment, 4 minutes for light /medium duty equipment, 5 minutes for medium- duty equipment, 7 minutes for heavy-duty equipment and 9 minutes for extra heavy duty equipment. **Important Note:** Refer to your Command Center Technical Manual for specific text displayed while the Ventilator is in a Wash Cycle.
5. Upon completion of the Wash Cycle, the baffle #1 stays in the closed wash position until the exhaust fan is re-started. Closing the baffle saves building energy by not allowing conditioned air from drafting up the exhaust duct, or in cold climates prevents cold air from coming down the duct and into the kitchen.

Note 1: If the Ventilator is equipped with a Gaylord Autostart Controller, the exhaust fan will stay on if the temperature at the sensor mounted in the canopy exceeds 90°F. (Refer to Figure 3-3-1). Once the temperature drops below 90°F., the fan will continue to run for 15 minutes and then shut off.

Note 2: The Command Center control may be programmed to automatically turn off the exhaust fan at a specific time. Refer to your Command Center Technical Manual for complete operating instructions.

Turning Off the Exhaust Fan and Starting the Wash Cycle – Cont.

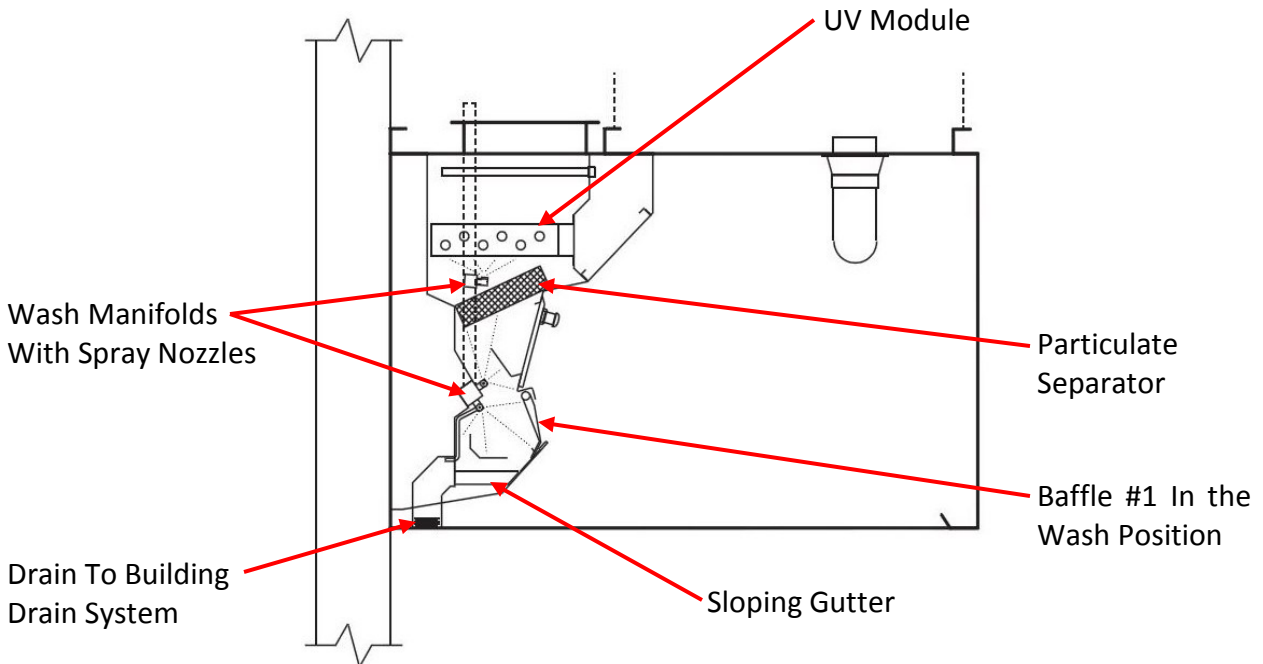

Figure 3-6-1
Wash Cycle

Length of Wash

The length of the Wash Cycle is primarily determined by the type of cooking equipment involved; Light Duty, Light/Medium, Medium Duty, Heavy Duty, and Extra Heavy Duty as shown Table T-3-7-1.. The factory recommended wash times are shown on table T-3-7-1 however the length of the Wash Cycle to adequately clean the Ventilator may vary depending on the following:

1. Actual amount of cooking within the hours of fan operation.
2. Type of food product being cooked.
3. Water pressure. Required pressure is 40 psi Min. to 80 psi Max.
4. Water temperature. Required temperature is 140 degrees F. Min. to 180 degrees F. Max.
5. Type of detergent. Refer to page 3-8 for recommend detergent.
6. Ratio of detergent to water.

Important Note:

The wash cycle may be programmed for different times as needed to adequately clean the grease extraction baffles, particulate separator and UV Lamps. The Command Center illustrated in this manual may not represent the model of Command Center you have. Refer to the Technical Manual for your specific model of Command Center for complete instructions on programming wash times. If you do not have a Technical Manual for your Command Center, obtain the model number from the nameplate on the Command Center and contact Gaylord Industries. Refer to page 1-1 for contact information.

Turning Off the Exhaust Fan and Starting the Wash Cycle – Cont.**Table T-3-7-1**

Minimum Factory Recommended Wash Cycle Times	
Type of Cooking Equipment	Length of Wash Cycle (in min.)
Light Duty – Ovens, steamers and kettles	3
Light/ Medium Duty – braising pans, tilting skillets, fryers, open burner ranges, hot top ranges, and conveyor ovens.	4
Medium Duty – griddles and grooved griddles.	5
Heavy Duty – gas and electric char broilers, upright broilers, woks and conveyor broilers.	7
Extra Heavy Duty – solid fuel broilers	9

Recommended Detergent

Overview

FORMULA G-510EF is the only cleaner recommended by Gaylord Industries for use in the wash down system of The Gaylord Ventilator. FORMULA G-510EF is a concentrated colloid cleaner specially formulated to remove the daily accumulation of grease inside the Ventilator without damaging the rubber and synthetic parts of the solenoid valves and the detergent pumping system. FORMULA G-510EF is safe for kitchen personnel and has a variety of uses.

FORMULA G-510EF Safety

FORMULA G-510EF is registered with the U.S. EPA's Design for the Environment Program (DfE) which seeks to promote the use of institutional cleaners and maintenance products with improved environmental and human health characteristics.

FORMULA G-510EF for the Ventilator Wash System

Pour FORMULA G-510EF directly into the detergent tank located inside the Wash Control Cabinet (Refer to Figure 2-11-2). The detergent pump injects the detergent into the Main Feed Line where it dilutes with the hot water at the proper ratio (Refer to Figure 2-11-2).

FORMULA G-510EF for Cleaning the Ventilator Exterior

Mix one part FORMULA G-510EF to twenty parts water in hand spray bottle. Spray on, let stand for a few minutes and wipe off.

FORMULA G-510EF for Other Cleaning Jobs

The colloidal action of FORMULA G-510EF makes it a cleaner especially well-suited for use in kitchens. The colloids break up dirt and grease into millions of tiny particles that constantly repel each other. These particles cannot recombine or redeposit on a surface and are, therefore, easily washed away. FORMULA G-510EF contains no harsh chemicals, yet offers outstanding performance on the toughest cleaning jobs.

Use a mixture of one part FORMULA G-510EF to twenty parts water for:

- VINYL/PLASTIC/WALLS...Removes dirt, grease, food deposits and fingerprints.
- REFRIGERATORS...Removes dirt, spilled milk, blood, mildew and objectionable odors.
- RESTROOMS...Add a disinfectant to clean all fixtures, walls, floors, etc.

Use a mixture of one part FORMULA G-510EF to five parts water for extremely heavy grease build-up, such as on the floor and on equipment around deep-fryers. Spray on, let set for a few minutes and rinse or wipe off. For extremely soiled areas, gentle agitation, followed by a soaking period, will result in more thorough cleaning. DON'T be afraid to experiment with FORMULA G-510EF because it contains no phosphates, nitrates, enzymes, sulfates, suffocates or silicates.

Recommended Detergent – Cont.

Formula G-510EF Limited Warranty

2010 Products, Inc. warrants that FORMULA G-510EF will not cause cleansing agent damage to the rubber and synthetic parts of the injection pump (“O” rings, diaphragms, washers, tubing, and other such parts) used with The Gaylord Ventilator, Heat Reclaim Unit, or Pollution Control Equipment so long as used pursuant to its product instructions. 2010 Products, Inc. obligation under this warranty and any warranties implied by law shall be limited to repairing or replacing, at its option, any of said parts which 2010 Products, Inc. examination shall disclose to its satisfaction to have been damaged by the use of FORMULA G-510EF for the life of the detergent pumping system. This warranty shall not cover damages caused by any other detergent. The use of any other detergent shall void this warranty. All repairs and replacement parts under this warranty shall be F.O.B. 2010 Products, Inc. The owner shall pay the necessary freight and delivery charges; also removal and installation costs. Any federal, state or local taxes are also extra. Requests for repairs or replacement part should be made to 2010 Products, Inc., P.O. Box 7609, Salem, Oregon, 97303. This is the sole warranty with respect to FORMULA G-510EF.

2010 Products, Inc. MAKES NO OTHER WARRANTY OF ANY KIND WHATSOEVER, EXPRESSED OR IMPLIED, AND ALL IMPLIED WARRANTIES OF MERCHANTABILITY AND FITNESS FOR A PARTICULAR PURPOSE WHICH EXCEED THE AFORESAID OBLIGATION ARE HEREBY DISCLAIMED AND EXCLUDED FROM THIS AGREEMENT. 2010 Products, Inc. SHALL NOT BE RESPONSIBLE FOR INCIDENTAL OR CONSEQUENTIAL DAMAGES RESULTING FROM A BREACH OF THIS WARRANTY.

IMPORTANT

If a cleansing agent other than FORMULA G-510EF is used with The Gaylord Ventilator injection pump and solenoid valves, it is recommended that a warranty similar to the above be obtained from the manufacturer of said product, that the detergent has foaming properties similar to FORMULA G-510EF and that the above-referenced Warranty shall become null and void.

Formula G-510 Distributor

For the name and address of the nearest FORMULA G-510EF distributor contact:

Gaylord Industries
10900 SW Avery Street
Tualatin, OR 97062

E-mail: info@gaylordventilation.com
Website: www.gaylordventilation.com
Phone: 800-547-9696

This Page Intentionally Left Blank

Operator Preventive Maintenance

Overview

To maintain the Gaylord Ventilator in good working order and to keep the system operating at optimum efficiency, preventive maintenance, using the following schedule, should be performed.

Important Note: The UV Lamps require special maintenance as described on page 4-3. Some of the required maintenance on the UV Lamps can be performed by the operator. However, direct exposure to UV light is hazardous to your skin and eyes and contact with live electrical components poses a significant risk of shock or death.

Recommended Scheduled Maintenance

Daily

1. Make sure the green "UV System On" lamp on the Ventilator and is on when the exhaust fan is on. If the light is not on refer to the Troubleshooting procedures on Page 5-8.
2. For general cleanliness the underside of the Ventilator should be wiped down as shown in Figure 4-2-1.

Weekly

1. The Detergent Tank, located in the Wash Control Cabinet, should be checked and kept full with detergent. Refer to Page 3-8 for recommend detergent.

Monthly

1. The detergent fittings should be checked. This is an airtight system and fittings should be tight. For complete details on the Detergent Pump refer to your Command Center Technical Manual.
2. At the conclusion of a Wash Cycle, open the Extractor Inspection Doors and remove the Particulate Separators (Refer to Figure 3-6-1). Check the extractor area, Particulate Separators, and UV Lamps to ensure they are adequately cleaned. If the Particulate Separators are not clean, run them through a dishwasher. If overall cleaning appears to be inadequate, refer to the Troubleshooting procedure on Page 5-5 for corrective action.
3. Check the entire Grease Gutter and Drain Outlet and remove any foreign material such as paper towels, order chits etc. Also check to ensure the gutter is being adequately cleaned by the Wash Cycle. If overall cleaning appears to be inadequate, refer to the Troubleshooting procedure on Page 5-5.

Every Six Months

1. Check the exhaust fan(s) for belt tightness, belt alignment. Lubricate moving parts as required. Note: A blue lithium based grease is best suited for high heat and speed bearing lubrication.
2. Check for proper velocity at the air inlet slot. Refer to page 6-1 for procedures.
3. Clean the Detergent Tank and Foot Valve.

Operator Preventive Maintenance – Cont.

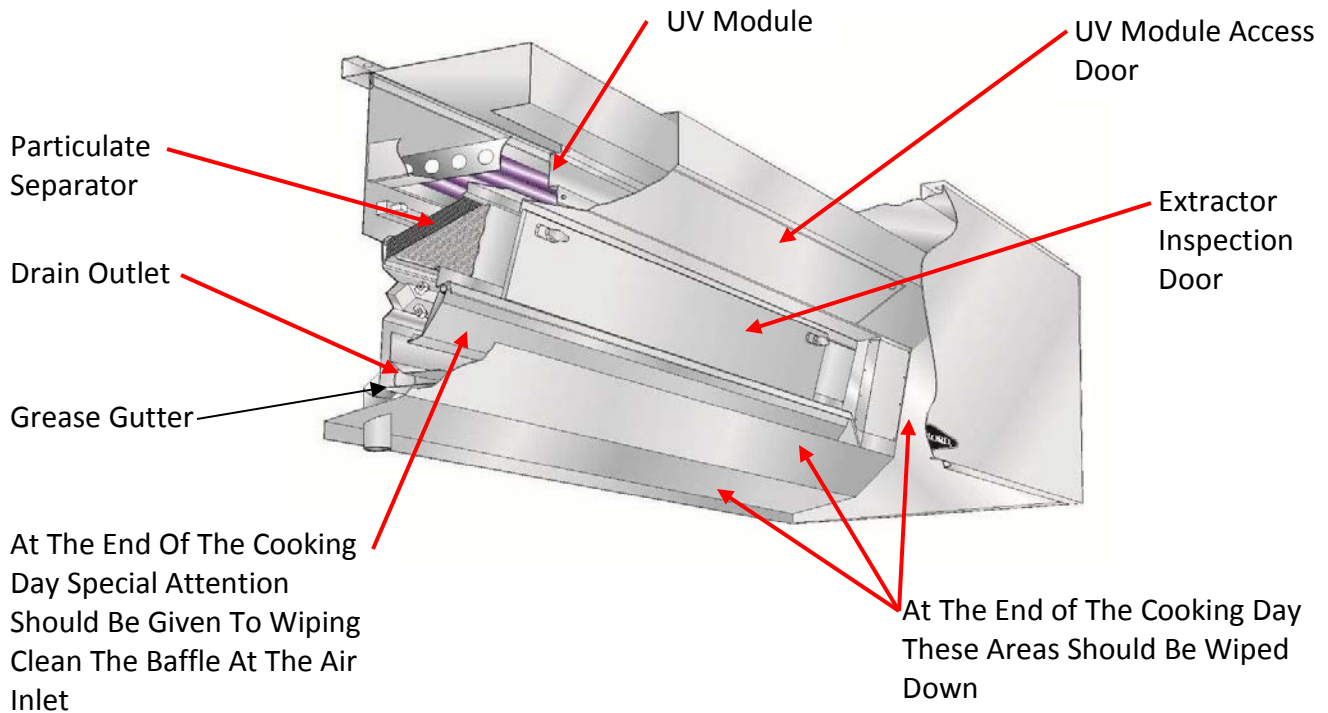

Figure 4-2-1
CG3-UV Ventilator Cut Away View

Preventive Maintenance Required by Code

Inspection and Cleaning Requirements

NFPA-96 (Standard for Ventilation Control and Fire Protection of Commercial Cooking Operations) require that hoods (Ventilators), ducts and exhaust fans must be inspected by a properly trained, qualified and certified company or person(s) in accordance with the following table.

Table T-4-2-1

Exhaust System Inspection Schedule	
Systems serving solid fuel cooking operations	Monthly
Systems serving high-volume cooking operations such as 24-hour cook, charbroiling or wok cooking	Quarterly
Systems serving moderate-volume cooking operations	Semi-annually
Systems serving low-volume cooking operations	Annually

Preventive Maintenance Required by Code – Cont.

Upon inspection, if found to be contaminated with deposits from grease laden vapors, the entire exhaust system shall be cleaned by a properly trained, qualified, and certified company or person(s) acceptable to the authority having jurisdiction.

When a vent cleaning service is used, a certificate showing date of inspection or cleaning shall be maintained on the premises. After cleaning is completed, the vent cleaning contractor shall place or display within the kitchen area a label indicating the date cleaned and the name of the servicing company. It shall also indicate area's not cleaned.

CAUTION regarding pressure washing or steam cleaning: The UV Modules must be removed prior to pressure washing or steam cleaning. **Very Important Note:** When the UV Modules are removed the opening **MUST** be blocked to prevent water or steam from entering the electrical raceways. Blocking Plates are provided when the Ventilator was shipped from the factory. Blocking Plates may be obtained from Gaylord Industries.

UVi System Scheduled Preventive Maintenance

CAUTION: Preventive maintenance and repairs made to the UV System as outlined on pages 6-7 through 6-41 **MUST** be performed by Gaylord Certified Service Agent. For a list of Gaylord Certified Service Agencies (CSA's) visit www.gaylordventilation.com and go to "Service Agencies".

WARNING: Certified Service Agent maintenance and repair warning. Do not defeat any Safety Interlocks during cleaning, maintenance and repair.

Safety Requirements

Caution: Exposure to UV light is harmful to skin and eyes. Before servicing or repairing any of the UV System read and performs the following safety requirements.

Overview

The CG3-UVi Ventilator is equipped with light attenuation barriers and Safety Interlocks to protect operators from direct exposure to UV light. All safety precautions called for in this manual must be followed to avoid the potential for harm to service personnel or operators.

As with many types of technology if it is not used properly and/or proper precautions are not taken there is the potential for injury or harm. This is especially true with UV light due to the fact that it does not physically hurt at the time of exposure. UV generated in these Ventilators is greater than what results from direct exposure to the sun. Under no circumstances is it acceptable to view the lighted lamps without proper eye protection or expose bare skin directly to the light. All safety precautions called for in this manual must be followed to avoid the potential for harm to service personnel and/or operators.

Personal Protective Equipment

1. Eye protection that prevents 100% of UV light from being transmitted through the lens must be worn at all times when replacing the UV Lamps on any CG3-UVi Series Ventilator that is energized and/or has the potential to be energized and expose personnel to UV light.

UV System Scheduled Preventive Maintenance – Cont.

2. Whenever service work is performed it is recommended that long sleeve shirts and pants be worn to minimize the potential for inadvertent exposure of the skin to UV light.

Preventive Maintenance

The following Preventive Maintenance items must be performed by a trained and qualified Certified Service Agency at a frequency shown on page 4-2, Table T-4-2-1, EXHAUST SYSTEM INSPECTION SCHEDULE. These tasks involve potential exposure to high doses of UV light and live electrical components. There is a risk of shock, injury and/or death from contact with live electrical components.

1. Testing UV Lamps and Ballasts

(For these tests all Extractor Inspection Doors and all UV Module Access Doors must be closed and secured)

- a) Turn on the exhaust fan at the Gaylord Command Center. The “UVi System On” green Status Light in each Ventilator Section should be on. In addition to the Status Lights on the Ventilator, the Gaylord Command Center displays text indicating the similar message as the Status Lights.
- b) If the yellow “UV Lamp Failure” Status Light is on it indicates that one or more of the UV Lamps are not operating. To troubleshoot and replace a lamp refer to the Troubleshooting section page 5-8, and the Testing and Repair section of this manual beginning on page 6-7.
- c) If a Blue “UV System Standby” Status Light is on it indicates that one or more Extractor Inspection Doors and/or one or more UV Module Access Doors have not been closed properly.

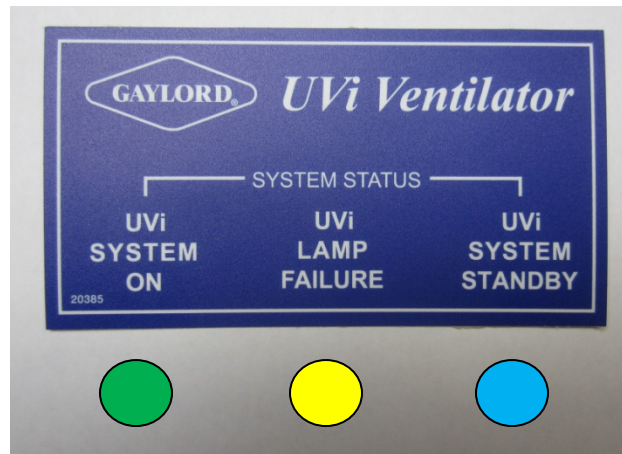

Figure 4-4-1
UV Status Lights

2. Inspect and Clean UV Modules

- a) Turn off all power to the Gaylord Command Center.
- b) Turn off all circuits that supply power to the UV Lamps.
- c) Open the UV Module Access Door (Refer to Figure 4-5-3).
- d) Disconnect the Lamp / Ballast Connector plug (Refer to Figure 4-5-1 and 4-5-2).

UV System Scheduled Preventive Maintenance – Cont.



Figure 4-5-1
UV Module End of Plug



Figure 4-5-2
Ventilator End of Plug

- e) Remove the eight nuts that hold the Module in place.
- f) Carefully slide out the UV Module and place on a work bench.
- g) Using a damp non abrasive cloth and mild detergent, wipe down the Lamps and Lamp Housing. Lamps should be free of all grease and debris.
- h) **Very Important;** Carefully inspect the UV Module Access Door Gasket for cracks or deterioration (Refer to Figure 4-5-3. Replace as needed to ensure a good seal. Refer to Page 4-40 for instructions on replacing.

Note: A deteriorating Access Door Gasket will allow grease to migrate into the UV Module and Main Electrical Raceways and cause the UV Module and other electrical components to fail.

- i) Slide the UV Module back into the Ventilator, replace the 8 nuts and tighten to 7-9 in / lbs.
- j) Reconnect the Lamp / Ballast Connector plug.
- k) Close the UV Module Access Doors.
- l) Turn on the power to the Command Center.
- m) Turn on the circuit that supplies power to the UV Lamps.
- n) Start the exhaust fan and make sure the “UVi System On” green Status Light in each Ventilator Section is on.

UV Module Access
Door In Open
Position



UV Module Access
Door Gasket

Figure 4-5-3
UV Module Access Door

UV System Scheduled Preventive Maintenance – Cont.

3. Test the Extractor Inspection Door Safety Proximity Switch.

(Caution: For the following tests Polycarbonate Safety Glasses must be worn.)

- a) Turn on the exhaust fan at the Command Center. The “UVi System On” green Status Light in each Ventilator Section should be on.
- b) Open the Extractor Access Door at the left end of the Ventilator. The Blue “UVi System Standby” Status Light should come on. If this action does not occur, immediately shut down the exhaust fan at the Command Center. Refer to the Troubleshooting section of this manual for corrective action.
- c) If there is more than one Ventilator section, repeat the tests above, 3a and 3b, for each section.

4. Test the UV Module Access Door Safety Switch

(Caution: For the following tests Polycarbonate Safety Glasses must be worn.)

- a) Turn on the exhaust fan at the Command Center. The “UVi System On” green Status Light in each Ventilator Section should be on.
- b) Open one UV Module Access Doors (Refer to Figure 4-5-3). The Blue “UVi System Standby” Status Light should come on. If this action does not occur, immediately shut down the exhaust fan at the Command Center. Refer to the Trouble Shooting section beginning on page 5-8 for corrective action.
- c) If there is more than one Ventilator section, repeat the tests above, 4a and 4b, for each section.

5. Lamp Replacement

The UV Lamps need to be replaced after 13,000 hours of use. After 13,000 hours the Lamps will still work but the performance of the Lamps decreases dramatically. The Gaylord Command Center has a built-in UV hours of operation clock. Refer to the Technical Manual for the Gaylord Command Center for complete operational instructions. If the Lamps have been in use over 13,000 hours they should be replaced. Refer to Page 6-7 of this manual for detailed instructions for replacing Lamps.

Using the Troubleshooting Charts

The following Troubleshooting Charts are designed to easily find common problems, the probable cause and guidance on corrective action. In some cases the Corrective Action column will reference the Testing and Repair section of this manual for additional guidance and actions.

Table T-5-1

Smoke Loss		
Symptom	Probable Cause	Corrective Action
1 The Ventilator is not exhausting all the smoke, heat and grease properly.	A. Exhaust volume is low due to fan performance issues. Measure the exhaust volume as described on page 6-2.	1 Check exhaust fan for broken or slipping belts. Adjust or replace belts as required.
		2 Confirm proper rotation of fan wheel.
		3 Check for proper size of exhaust fan. Fan must deliver Ventilator Nameplate rating.
		4 Check for open access panel in duct system and close or re-install.
	B. Exhaust volume is low due to a heavy grease accumulation in the extractor area or the Particulate Separators.	1 Open the Extractor Inspection Door and inspect for grease accumulation around the baffles and the Particulate Separators. If they are not being washed effectively refer to the Troubleshooting section on WASH CYCLE.
	C. The Ventilator must have its own exhaust system and no other exhaust, such as dishwasher hoods should be tied into it.	1 Inspect the duct system and verify that there are no other non Type I Ventilator systems tied in. If so they must be removed.
	D. Improperly placed make-up air diffusers.	1 Make-up air directed at the Ventilator will likely create cross drafts disrupting the air flow into the Ventilator. Adjust the louvers to direct the make-up air away from the Ventilator. Refer to page 6-5 for guidance.
		2 Make-up air should be delivered through registers at ceiling height, and distributed throughout the kitchen area. Refer to page 6-5 for guidance.
		3 Make-up air registers located near the Ventilator, the louvers should be adjusted to direct the air away from the Ventilator. Directing or forcing the make-up air at the Ventilator typically creates cross drafts resulting in smoke loss. Refer to page 6-5 for guidance.

Table T-5-2-1

Smoke Loss – Cont.		
Symptom	Probable Cause	Corrective Action
The Ventilator is not exhausting all the smoke, heat and grease properly.	E. Inadequate make-up air	1 Make-up air must be supplied for replacement of air exhausted through all kitchen exhaust systems. Refer to page 6-5 for guidance.
		2 A general "rule of thumb" is that 60% of the replacement air should be fresh, conditioned, (heated or cooled) air brought into the kitchen area, with the remaining 40% allowed to flow into the kitchen from adjacent areas. Refer to page 6-5 for guidance.
	F. Exhaust fan discharge	1 There should be no screen over the discharge. If one is found, it should be removed.
		2 The direction of discharge should not be into the prevailing winds or downward onto the roof. A vertical discharge is highly recommended.
	G. Baffle #1 (Damper) not open to the operating position (N/A on CG3-UVi-FDD, CG3-UVi-FDT, and CG3-UVi-ND).	1 Check outputs # 17 and 18 in the Command Center for voltage. Fan On = 0 VAC Fan Off = 24 VAC

Table T-5-3-1

Poor Grease Extraction		
Symptom	Probable Cause	Corrective Action
1 Poor grease extraction.	A. Ventilators exhausting too much air can cause an excessive amount of noise and allow grease to be pulled through the extraction chamber. Ventilators exhausting below design will also allow grease to be pulled through the extraction chamber.	1 Check for proper exhaust volume by following the instructions beginning on Page 6-1.
	B. Sticky grease may have accumulated within the extraction chamber, creating a higher velocity allowing grease to be pulled through.	1 Open the Extractor Access Door and inspect for grease accumulation. If the Ventilator is not being washed effectively refer to the Troubleshooting section on Wash System.

Table T-5-3-2

Exhaust Fan		
Symptom	Probable Cause	Corrective Action
1 If the START FAN button is pushed but the exhaust fan does not come on.	A. Overload protector on the magnetic starter has tripped.	1 Push the "Reset" button on the magnetic starter and push the START FAN button.
	B. If a HOA (Hands Off/Automatic) type magnetic starter switch is used, the selector switch may have been moved from the automatic position.	1 Check the switch and turn the selector to the automatic position.
	C. Exhaust fan circuit breaker tripped.	1 Re-set circuit breaker.
	D. If the system is equipped with a fused disconnect switch for the exhaust fan, a fuse or fuses may have blown out.	1 Check continuity of fuses and replace if necessary.
	E. The Gaylord Command Center may have been improperly wired.	1 Refer to the wiring diagrams in the Command Center Technical Manual.
	F. The Gaylord Command Center is malfunctioning.	1 Refer to the Command Center Technical Manual.

Table T-5-4-1

Exhaust Fan – Cont.		
Symptom	Probable Cause	Corrective Action
1 If the START FAN button is pushed and air is not being pulled through the Ventilator but you can hear the fan running.	A. Baffle #1 (the damper) closes each time the START WASH button is pushed. The damper may not be re-opening when the START FAN button is pushed. (N/A on CG3-UVi-FDD, CG3-UVi-FDT, and CG3-UVi-ND).	1 Push the START FAN button and observe the damper. If the damper does not move to exhaust position then there is either a mechanical or electrical malfunction. Refer to page 6-42 for instructions on corrective action.
	B. For Models CG3-UVi-FDD and CG3-UVi-FDT (Fire Damper in the duct collar) the damper may have closed.	1 Shut off electrical power at the Command Center. Open the UV Module Access Door closest to the exhaust duct collar, typically in the middle of the Ventilator. Remove the UV Module and check to see if the damper is closed.
	B. Fan drive belt is slipping or broken.	1 Tighten the belt or replace and then measure exhaust volume to verify. Refer to instructions on measuring exhaust volume beginning on page 6-1.
	C. Fan is running in reverse.	1 Contact electrical contractor to wire correctly.

Table T-5-5-1

Wash System		
Symptom	Probable Cause	Corrective Action
1 The Wash Cycle is not adequately cleaning the Extraction Chamber, the Particulate Separators or UV Lamps.	A. The water supply is turned off or partially off.	1 Check the hand valves inside the Wash Control Cabinet. Refer to Figure 2-7-2.
		2 Check any valves upstream of the Wash Control Cabinet.
	B. Low Water Pressure - Check the water pressure gauge inside the Command Center cabinet. Pressure should be 40 psi min. while the Ventilators are washing.	1 Check the hand valves inside the Wash Control Cabinet to make sure they are fully opened. Refer to Figure 2-7-2.
		2 Check any valves upstream of the Wash Control Cabinet to make sure they are fully opened.
		3 The Line Strainer inside the Wash Control Cabinet may be clogged. Refer to the Technical Manual for the Gaylord Command Center and Wash Control Cabinet for instructions on cleaning the Line Strainer.
	C. Low Water Temperature - Check the temperature gauge inside the Wash Control Cabinet. The temperature should be between 140 degrees F. to 180 degrees F.	1 If below temperature it must be increased at the hot water source.
	D. Inadequate length of Wash Cycle.	1 Refer to Page 3-6 for guidance.
	F. Detergent tank empty.	1 Check and fill the detergent tank at least weekly.
	G. Improper detergent.	1 Refer to Page 3-8 for recommended detergent.
	H. Detergent pump has lost its prime or is malfunctioning.	1 Refer to the Technical Manual for the Gaylord Command Center and Wash Control Cabinet, the Troubleshooting section.
I. Clogged Spray Nozzle(s).	1 While the Wash Cycle is on, open the Extractor Inspection Door slightly and visually inspect the spray of the nozzles. If clogged, remove and clean by running a small wire through the orifice.	

Table T-5-6-1

Wash System – Cont.		
Symptom	Probable Cause	Corrective Action
2 Water sprays never come on.	A. Malfunction water solenoid valve located in the Wash Control Cabinet.	1 Refer to the Technical Manual for the Gaylord Command Center and Wash Control Cabinet, the Troubleshooting section.
	B. Malfunction in the Command Center control.	1 Refer to the Technical Manual for the Gaylord Command Center and Wash Control Cabinet, the Troubleshooting section.
3 Wash is spraying when the Command Center is <u>not</u> in a Wash Cycle.	A. Water Solenoid Valve in the Wash Control Cabinet is stuck in the open position.	1 Gently tap the valve housing with a hammer. This should release foreign material trapped in the valve and the water should stop. If tapping does not release the valve must be disassembled and checked. Refer to the Technical Manual for the Gaylord Command Center and Wash Control Cabinet for instructions.
4 When the START WASH button is pushed and baffle #1 (damper) does not move to the wash position.	A. The Command is in an Internal Fire Mode.	1 Refer to the Technical Manual for the Gaylord Command Center and Wash Control Cabinet, the Troubleshooting section.

Table T-5-7-1

Drains		
Symptom	Probable Cause	Corrective Action
1 If during a Wash Cycle water overflows the gutter and comes out the inlet slot.	A. Clogged drain outlet. (Note: each Ventilator section has its own drain outlet).	1 The drain outlet is typically located at either the right or left end of the Ventilator. Open the Extractor Inspection Door at both ends of the Ventilator, reach in and down into the bottom of the Grease Gutter until the drain outlet is found. Remove any grease or debris found.
	B. The building drain system may be clogged. (If more than one Ventilator section is not draining it indicates that the building's drain system is clogged).	1 A chemical drain cleaner applied per instructions may dissolve stoppage. Pour cleaner into the Grease Gutter at the drain opening.
		2 Hire a drain roter service to clear the entire drain system.
	D. Clogged or full grease trap.	1 Some cities and counties have codes which require grease traps. If a grease trap is in use, check to ensure that it is not clogged.

Table T-5-8-1

UV System		
Symptom	Probable Cause	Corrective Action
1 After exhaust fan is started and the UV Status lights on the Ventilator section(s) illuminate as follows: 1. Green light is Off . 2. Yellow light is Off . 3. Blue light is On .	A. Extractor Inspection Door open.	1 Close door.
	B. UV Module Access Door open.	1 Close door.
	C. UV Module Access Door Safety Switch has failed.	1 Test for electrical continuity of the switch. Replace if needed.
	D. Extractor Inspection Door Proximity Safety Switch has failed	1 Test for electrical continuity of the switch. Replace if needed.
	E. Airflow is too low.	1 Confirm Ventilator is at design exhaust volume. Refer to instructions beginning on page 6-1 for measuring exhaust volume.
	F. The temperature of the Main Electrical Raceway has exceeded 118° F. and the High Temperature Shutdown Controller has activated.	1 Confirm that Ventilation Fan mounted on top of the Ventilator has not failed. If failed, refer to page 6-30 for instructions on replacing. 2 Check to see that the Ventilation Fan inlet and out Ventilation Snorkel is not blocked by building insulation or any other material. Remove the material that is blocking the air inlet. 3 The cooking equipment under the Ventilator is in a "runaway" condition operating too hot. Check with owner to see if cooking equipment is operating properly.

Table T-5-9-1

UV System - Cont.		
Symptom	Probable Cause	Corrective Action
2 After exhaust fan is started and the UV Status lights on the Ventilator section(s) illuminate as follows: 1. Green light is On . 2. Yellow light is On . 3. Blue light is Off .	A. One or more UV Lamps has failed.	1 Refer to Page 6-7 for instructions on determining which Lamp has failed, and replacement.
	B. UV Ballast has failed.	1 Refer to page 6-19 for instructions on determining which Ballast has failed and replacing.
	C. Loose wires.	1 Check wires 1A and 3A from the Command Center to the UV Ballast. If either are loose, re-secure and tighten.
3 After exhaust fan is started and the UV Status lights on the Ventilator section(s) illuminate as follows: 1. Green light is Off . 2. Yellow light is On . 3. Blue light is Off .	A. No electrical power to the UV Ballast.	1 Check for electrical power on terminals L1 and L2 on the UV Ventilation Control Board. Refer to the wiring diagrams in Chapter 7.
		2 Check the Circuit Breaker.
	B. Lamp / Ballast Connector plug is unplugged.	1 Plug in connector. Refer to figure 6-9-1 and 6-9-2.
	C. Loose wire at the Command Center or on the Ventilation Control Board.	1 Check terminal 1U from UV Ballast back to the Command Center.
4 After the exhaust fan is started the UV Status Lights on the Ventilator sections do not illuminate.	A. No power on terminal 6U in the Command Center.	1 Check and replace the 4 amp fuse located in the Command Center. Confirm 6U is not shorted and the reason the fuse is blown. If 6U is shorted at some point, find the pinch or short and repair as needed.
	B. Loose wire.	1 Check for voltage on 5U and 6U. Re-secure any loose connections between the Ventilator and the Command Center.

Table T-5-10-1

UV SYSTEM - Cont.		
Symptom	Probable Cause	Corrective Action
5 Repeated Ballast / UV Lamp failures.	A. One or more UV Module Ventilation Fans have failed.	1 Test and replace if necessary. Refer to Page 6-32 for instructions.
	B. Main Electrical Raceway Ventilation Fan has failed.	1 Test and replace if necessary. Refer to Page 6-32 for instructions.
	C. Ventilation Fan inlet and out Ventilation Snorkel is blocked by building insulation or other material.	1 Check the Ventilation Fan inlet and out Ventilation Snorkel and remove any blockage.
	D. UV Module Access Door Gasket has failed allowing grease to be pulled into the Raceway.	1 Check and replace if necessary. Refer to Page 6-40 for instructions.
	E. UV Module Plate Gasket has failed allowing water or grease to leak into the UV Module Electrical Raceway.	1 Check and replace if necessary. Refer to Page 6-41 for instructions.
6 Command Center not functioning as intended.	A. Varies.	1 Refer to the Technical Manual for the Gaylord Command Center and Wash Control Cabinet, the Troubleshooting section.

Measuring Airflow

Overview

CG3-UVi Series Ventilators are factory engineered to operate at a specific exhaust volume, CFM (Cubic Feet per Minute), based on, primarily, the type of cooking appliance, their associated energy input, and the exact model of the Ventilator. Smoke capture, grease extraction efficiency and heat removal are dependent upon the proper exhaust volume (Airflow) through the Ventilator. If the exhaust volume is below design, smoke, grease and heat may escape the confines of the Ventilator creating an uncomfortable kitchen for the operators. It will also reduce grease extraction efficiency resulting in additional grease depositing in the duct system and exhaust fan. This can lead to sanitation problems and fire hazards if left uncorrected. If the exhaust volume is higher than design, more energy will be used to operate the exhaust fan, excessive noise levels may result, and grease can be pulled through the extraction baffles and Particulate Separator depositing in the duct and fan. Operating the Ventilator at higher or lower airflows than design will result in the entire kitchen ventilation system being out of balance.

It is important that at initial installation of the Ventilator the exhaust volume is measured to verify that it meets design. It is also recommended that the exhaust volume be measured once every two or three years to insure that the exhaust fan is operating properly. The exhaust volume for each Ventilator section is stamped on the Ventilator Nameplate (Refer to Appendix A-1 for a sample nameplate).

Measuring Airflow

The Ventilator exhaust volume may be determined by measuring the air inlet velocity, and using the Air Velocity Chart, Chart C-6-4-1 and C-6-4-2, determine the average exhaust volume in CFM Per Lineal Ft. of Ventilator and comparing this average to the designed CFM/Lineal Ft. as noted on the Gaylord Submittal Drawings. If the submittal drawing are not available, multiply the determined (as measured) CFM/Lineal Ft. times the length of the Ventilator in feet, and compare this total to the total exhaust volume as stamped on the Ventilator Nameplate.

The Air Velocity Chart gives the optimum inlet slot velocity and the minimum and maximum allowed velocities. If the velocity is below or above the minimum or maximum, the exhaust fan must be adjusted accordingly.

Important Note 1: The height of the inlet slot can vary depending upon the design of the Ventilator. All CG3-UVi Series Ventilators, except “DS” Series (Dual Slot), the nominal height of the inlet slot is either 3” or 4”. In order to use the chart properly it is therefore important to first measure the inlet slot (Refer to Chart C-6-4-1). On “DS” Series Ventilators the nominal height of the front inlet slot is always 3”. Use Chart C-6-4-2 for all “DS” Series.

Important Note 2: Some Ventilators may include Custom Air baffles to reduce the exhaust volume over light duty cooking equipment (Refer to Figure 6-3-1 and 6-3-2). To determine if the Ventilator has Custom Air baffles, refer to the Gaylord Submittal Drawings and the Custom Air baffles will be noted on the front elevation. If not available, open the Extractor Inspection Door and look for the top Custom Air baffle (Refer to Figure 6-3-1 and 6-3-2).

Measuring Airflow – Cont.

The standard instrument used for measuring the inlet velocities on a Gaylord Ventilator is a Pacer, Model DA40 or DA400 Digital Anemometer. This instrument is the easiest, most accurate and the best suited for measuring the Ventilator inlet slot velocities.

Instructions

To measure the air inlet velocity and confirm the exhaust volume, proceed as follows:

1. For safety purposes turn off the cooking equipment and allow to cool.
2. Confirm that all Particulate Separators are clean and in place.
3. Close all Extractor Inspection Doors.
4. Make sure all UV Module Access Doors are closed.
5. Turn on the exhaust fan.
6. Attach the Sensing Probe guide bracket, Gaylord Part Number [18408](#), to the Sensing Probe (Refer to Figure 6-23-1).
7. Attach the cable from the Sensing Probe to the meter (refer to Figures 6-2-1 and 6-2-2)
8. Attach the handle sections to the Sensing Probe.
9. Turn on the meter.
10. Beginning at one end of the Ventilator, place the sensing head against the inlet slot as shown in Figure 6-3-1. Allow the meter to stabilize.

Important Note 1: If the Ventilator includes Custom Air Baffles (Refer to Figure 6-3-1) it will be necessary to take two sets of readings, one for the section of Ventilator that includes Custom Air Baffles and one where it does not. Non Custom Air and Custom Air readings must be recorded separately. Do not average them together.

Important Note 2: On the rear slot of a BDL-DS Series, do not use the guide bracket (Refer to Figure 6-3-2). There is a Rear Slot Adjustable Baffle for balancing the front and rear slots to achieve the desired velocities as shown in Chart C-6-4-2.

11. Using the 16 second averaging feature (refer to the meter instructions) slide the Sensing Probe along the entire length of the slot, slowly, at a rate that would last approximately 16 seconds. If you reach the end of the Air Inlet Slot before the 16-Second interval has elapsed, continue moving the probe head back the other direction (without removing it) until the 16-Second sample interval has expired.
12. At the end of 16 seconds an average velocity will appear on digital readout of the meter.

Figure 6-2-1
Meter



Figure 6-2-1
Sensing Probe



Measuring Airflow – Cont.

13. The designed, or optimum velocity, is noted on the Submittal Drawings and on the Air Velocity Chart, C-6-4-1. If the velocities are not within the ranges as shown on Chart C-6-4-1 and C-6-4-2 refer to the Troubleshooting section of this manual for possible problems and corrective action.

If the velocities are within the range of the chart record the average velocity (FPM) on the Startup Inspection Report and Test Report form. Note: two velocities will be recorded if the Ventilator includes Custom Air Baffles. A sample report form, which can be photocopied, is provided in Appendix D.

14. Repeat the process for any additional Ventilator sections.

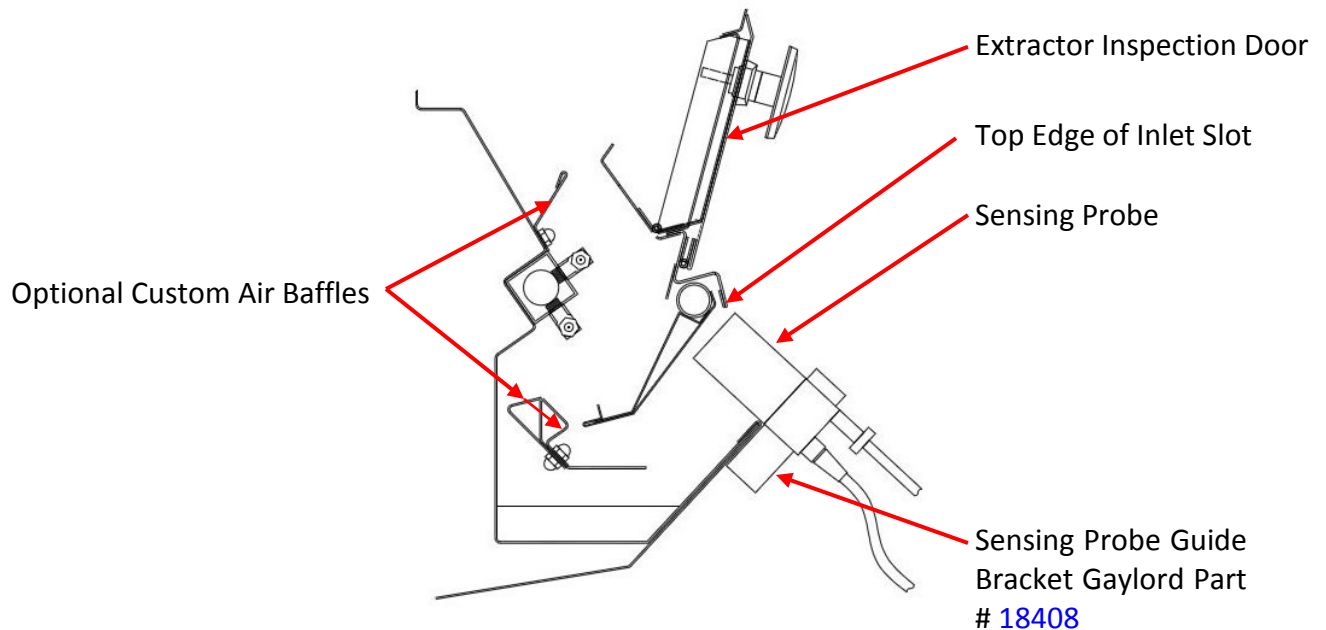

Figure 6-3-1
Typical Section View

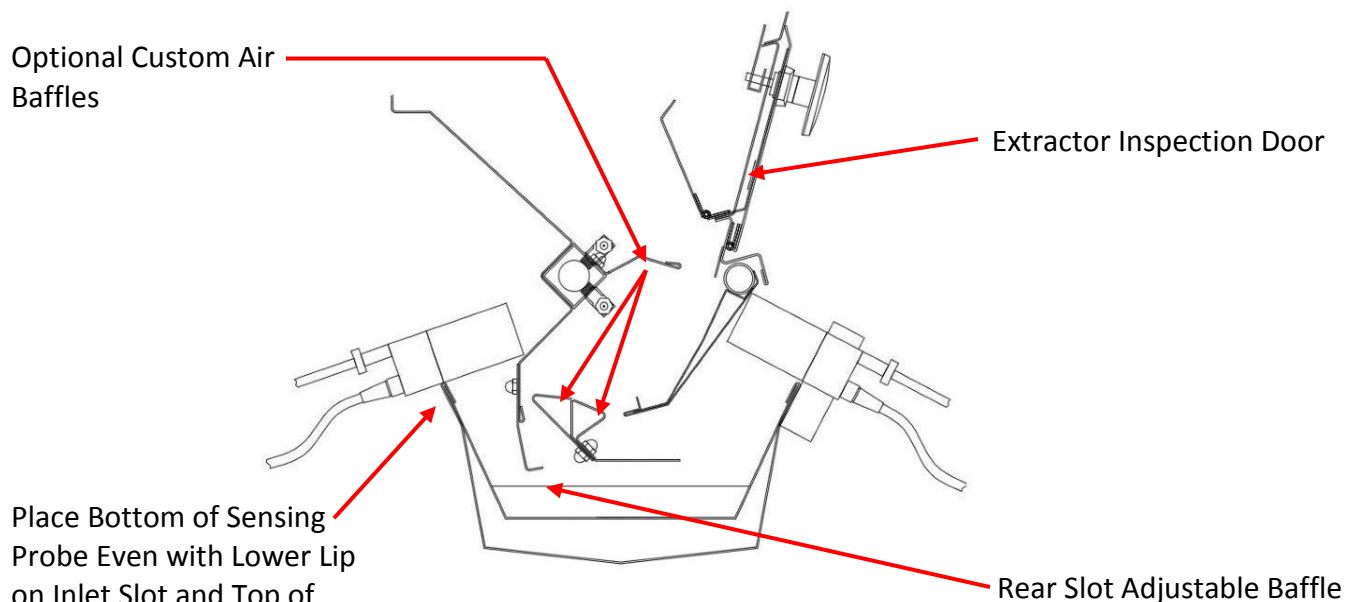

Figure 6-3-2
Typical Section View "DS" Series

Measuring Airflow – Cont.

Chart C-6-4-1									
For All CG3-UVi Series Except “DS” Series									
Nominal Height of Inlet Slot	Without Custom Air Baffles			With Custom Air Baffles			Static Pressure At Duct Collar		
	Designed CFM per Lineal Ft.	Average Inlet Slot Velocity (FPM)			Designed CFM per Lineal Ft.	Average Inlet Slot Velocity (FPM)			
		Min.	Optimum	Max.		Min.	Optimum	Max.	
3” (Std.)	250	1300	1380	1450	150	760	800	880	1.33
	270	1360	1435	1500	160	790	830	870	
	285	1425	1500	1575	170	810	855	900	1.65
	300	1465	1545	1625	180	845	880	935	1.70
4” (Enl.)	400	1690	1780	1870	250	1040	1095	1150	1.65
	405								1.70

Chart C-6-4-2									
For All “DS” Series (Dual Slot)									
Designed CFM Per Lineal Ft.			Required Average Inlet Slot Velocity (FPM)						Static Pressure At Duct Collar
Total CFM Both Slots	Front Slot	Rear Slot	Front Slot			Rear Slot			
			Min.	Optimum	Max.	Min.	Optimum	Max.	
300	150	150	760	800	880	595	625	655	1.65
400	250	150	1375	1450	1520	595	625	655	1.65

Make- Up Air Guidelines

Capture Performance

All Gaylord Ventilators are factory engineered to operate at a specific exhaust volume, CFM (Cubic Feet per Minute), based on, primarily, the type of cooking appliance, and the exact model of the Ventilator. Capture performance is based on two primary functions, 1) the Ventilator is exhausting the engineered CFM and 2) the Makeup-Air is being introduced correctly. Makeup-Air introduced incorrectly will typically result in smoke and heat loss into the kitchen, even if the Ventilator is operating at the engineered CFM. Makeup-Air is typically brought into the kitchen space through ceiling diffusers or through a combination of Gaylord Makeup-Air Plenum Boxes, Model PBW, (Refer to Figure 6-6-2) and ceiling diffusers.

Capture and Performance Guarantee

Gaylord Industries provides the following guarantee for all Gaylord Ventilators:

Gaylord Capture Performance Guarantee

Gaylord Industries warrants the Capture Performance of the Ventilator, only if the Exhaust Air Volumes are correct, per the Exhaust Volume Guidelines as stated below, and the Makeup-Air Volumes are correct and delivered correctly per the Makeup-Air Delivery Guidelines as stated below.

Exhaust Volume Guidelines

The amount of exhaust CFM through the Ventilator shall be between 100% and 110% of the values stamped on the Ventilator Nameplate for each Ventilator section.

Makeup-Air Delivery Guidelines

A. With Gaylord Plenum Boxes and ceiling diffusers.

- 1) Gaylord Plenum Boxes Model PBW shall be located immediately in front of the Ventilator, a minimum of 18" from the lower lip of the Ventilator to the discharge surface of the Plenum Box. (refer to Figures 6-6-1 and 6-6-2).
- 2) The amount of Makeup-Air delivered through the Gaylord Plenum Box(s) shall be between 90% and 100% of the values shown on Gaylord Submittal Drawings.
- 3) The amount of Makeup-Air through the Plenum Boxes shall not exceed 60% of the exhaust volume of the Ventilator.
- 4) Ceiling diffusers shall be at least 6'-0" away from all sides of the Ventilator and the outlet velocity at the diffusers shall not exceed 150 Feet per Minute (FPM).

B. With ceiling diffusers only.

- 1) Ceiling diffusers shall be at least 15'-0" away from all sides of the Ventilator and the outlet velocity at the diffusers shall not exceed 300 Feet per Minute (FPM) (Refer to Figure 6-6-1).

C. Additional Requirements.

- 1) The maximum velocity of the Makeup-Air from diffusers, transfer air diffusers, or any other type of diffusers shall not be greater than 75 FPM on all open sides of the lower edge of the Ventilator.
- 2) Cross drafts from pass through windows, hallways, or other openings shall not exceed 50 FPM.
- 3) All forms of Makeup-Air, such as ceiling diffusers, transfer air diffusers, and Plenum Boxes must be evenly distributed around each Ventilator to prevent unequal pressurization.
- 4) Kitchen pressurization shall not exceed - 0.02" W.G. relative to the dining or adjacent spaces as stated in NFPA-96 and ASHRAE Standard 154.
- 5) For more information on acceptable methods of Makeup air delivery reference ASHRAE Standard 154.

Make- Up Air Guidelines – Cont.

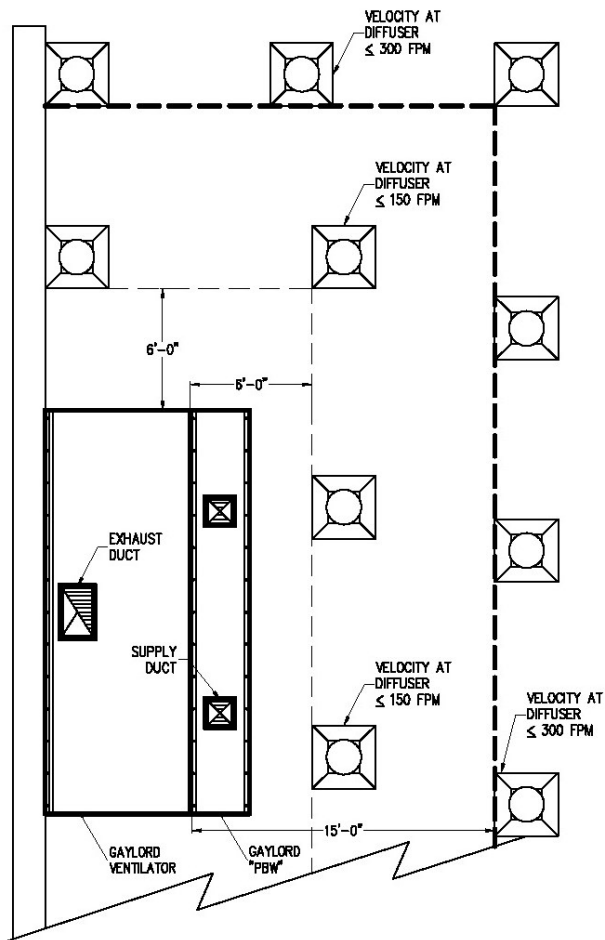

Following these guidelines will result in proper capture and containment at the Ventilator and enact the Gaylord Capture Performance Guarantee. If jobsite conditions cannot accommodate these guidelines, consult Gaylord Industries for alternative design.

Figure 6-6-1
Plan View – Typical Kitchen

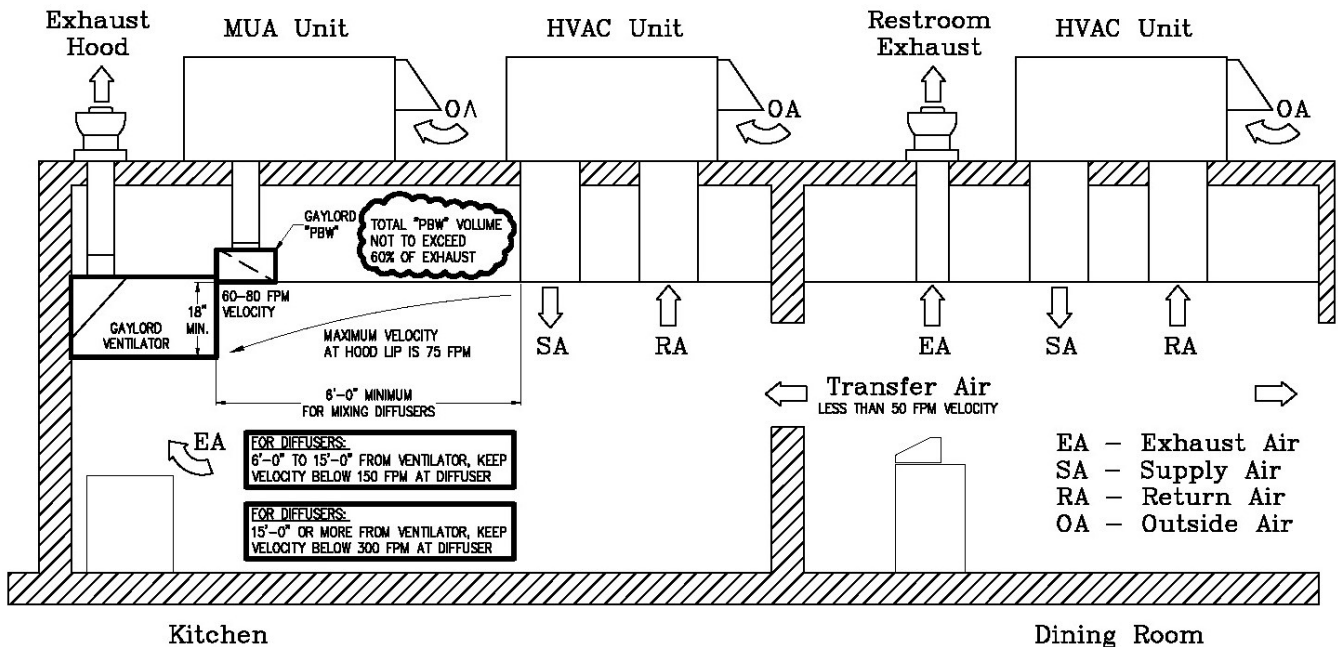

Figure 6-6-2
Section View – Typical Kitchen

Replacing UV Lamps

Overview

The UV Lamp Modules come in two lengths, a nominal 3'-0" and 5'-0". The length and number of modules is dependent on the length of the Ventilator section (Refer to Table T-6-7-1). There are six UV Lamps in each Module. Lamp #1 is at the front of the UV Module and Lamp #6 is at the back of the Module (Refer to Figure 6-7-1). If the "UVi LAMP FAILURE" yellow status light on the Ventilator is on it indicates that one or more Lamps has failed and it must be replaced.

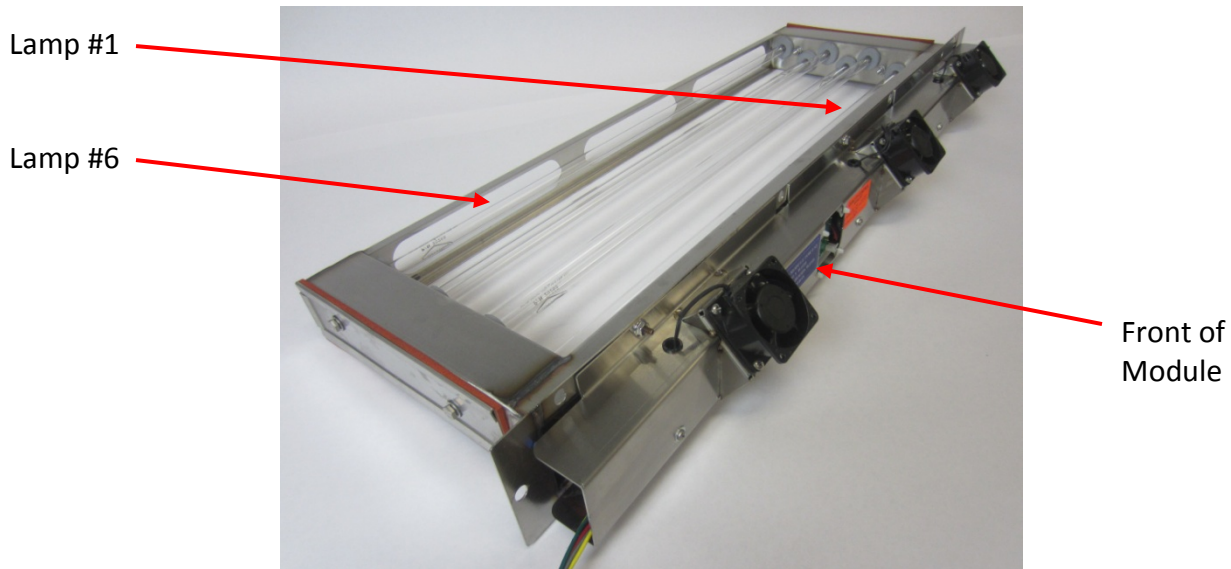

Figure 6-7-1
Typical UV Module

Table T-6-7-1

Number of UV Lamp Modules		
Active Ventilator Length	Number of 3'-0" Modules	Number of 5'-0" Modules
4'-0" – 6'-5"	1	0
6'-6" – 7'-5"	0	1
7'-6" – 9'-11"	2	0
10'-0" – 12'-5"	1	1
12'-6" – 16'-0"	0	2

Replacing UV Lamps – Cont.

Replacing UV Lamps

DANGER: Replacing UV Lamps as outlined on the following pages **MUST** be performed by a Gaylord Certified Service Agent. For a list of Gaylord Certified Service Agencies (CSA's) visit www.gaylordventilation.com and click on "Service Agencies".

SAFETY PRECAUTIONS

Tasks required to replace UV Lamps involve potential exposure to high doses of UV light and live electrical components. There is a risk of serious injury to skin and eyes from UV light. There is a risk of shock, injury, and /or death from live electrical components.

Personal Protective Equipment

1. Eye protection that prevents 100% of UV light being transmitted through the lens must be worn at all times when replacing the UV Lamps on any CG3-UVi Series Ventilator that is energized and/or has the potential to be energized and expose personnel to UV light.
2. Whenever service work is performed it is recommended that long sleeve shirts and pants be worn to minimize the potential for inadvertent exposure of the skin to UV light.

Instructions for Determining Which UV Lamps Have Failed

Caution: Determining which UV Lamps have failed requires the use of UV protective glasses as a small amount of UV light may be visible.

1. With the exhaust fan on, open the UV Module Access Door. Push and hold in the Door Safety Switch (Refer to Figure 6-12-1) and look at the UV Monitoring Status Board (Refer to Figure 6-8-1). There is one green light for each of the six Lamps and the light on the left is for Lamp #1 and on the right is for Lamp #6. A green light off indicates that specific Lamp as failed and it must be replaced.

Status Light For
Lamp #1

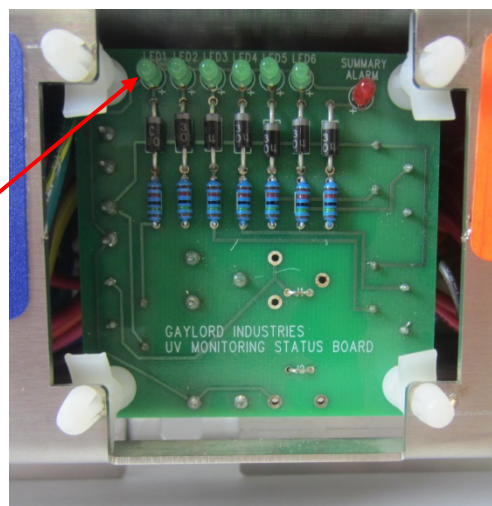

Figure 6-8-1
UV Monitoring Status Board

Replacing UV Lamps – Cont.

Instructions for Replacing UV Lamps

To replace UV lamps carefully use the following step by step instructions.

1. Turn off all power to the Gaylord Command Center.
2. Turn off all circuits that supply power to the UV Lamps.
3. Open the UV Module Access Door.
4. Disconnect the Lamp / Ballast Connector plug (Refer to Figure 6-9-1 and 6-9-2).



Figure 6-9-1
UV Module End of Plug



Figure 6-9-2
Ventilator End of Plug

5. Remove the eight nuts that hold the Module in place.
6. Carefully slide out the UV Module and place on a work bench.
7. Next, remove the Module End Caps from each end of the Module. Using a box or open end wrench, hold the End Cap Nut on the back side of the end (Refer to Figure 6-9-3) while backing out the End Cap Bolt from the front side of the End Cap (Refer to Figure 6-9-4). There is a retainer washer on the back side of the End Cap that prevents the bolt from sliding out of the End Cap.



Figure 6-9-3
End Cap Nuts

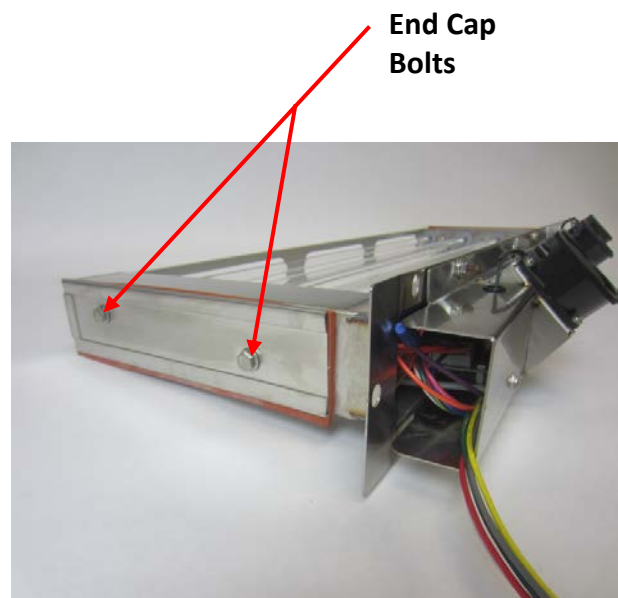

Figure 6-9-4
End Cap Bolts

Replacing UV Lamps – Cont.

8. The sockets, with wires, that slide onto the ends of the UV Lamps are called UV Lamp Sockets (Refer to Figure 6-10-1). The wires are marked from the Factory with numbers 1 through 6 on the left end and 7 through 12 on the right end (Refer to Figure 6-10-2).

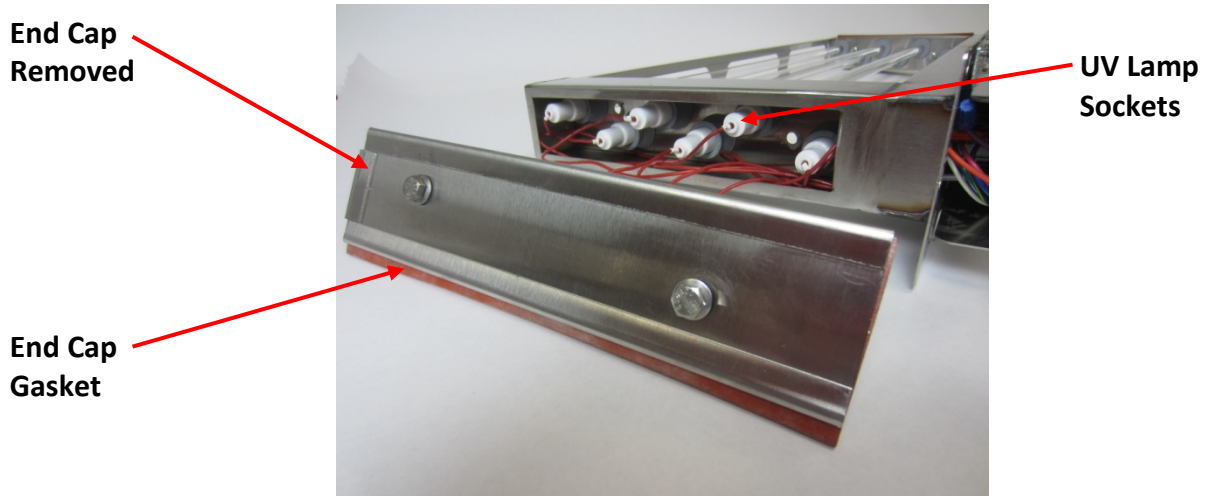

Figure 6-10-1
UV Module End Cap Removed

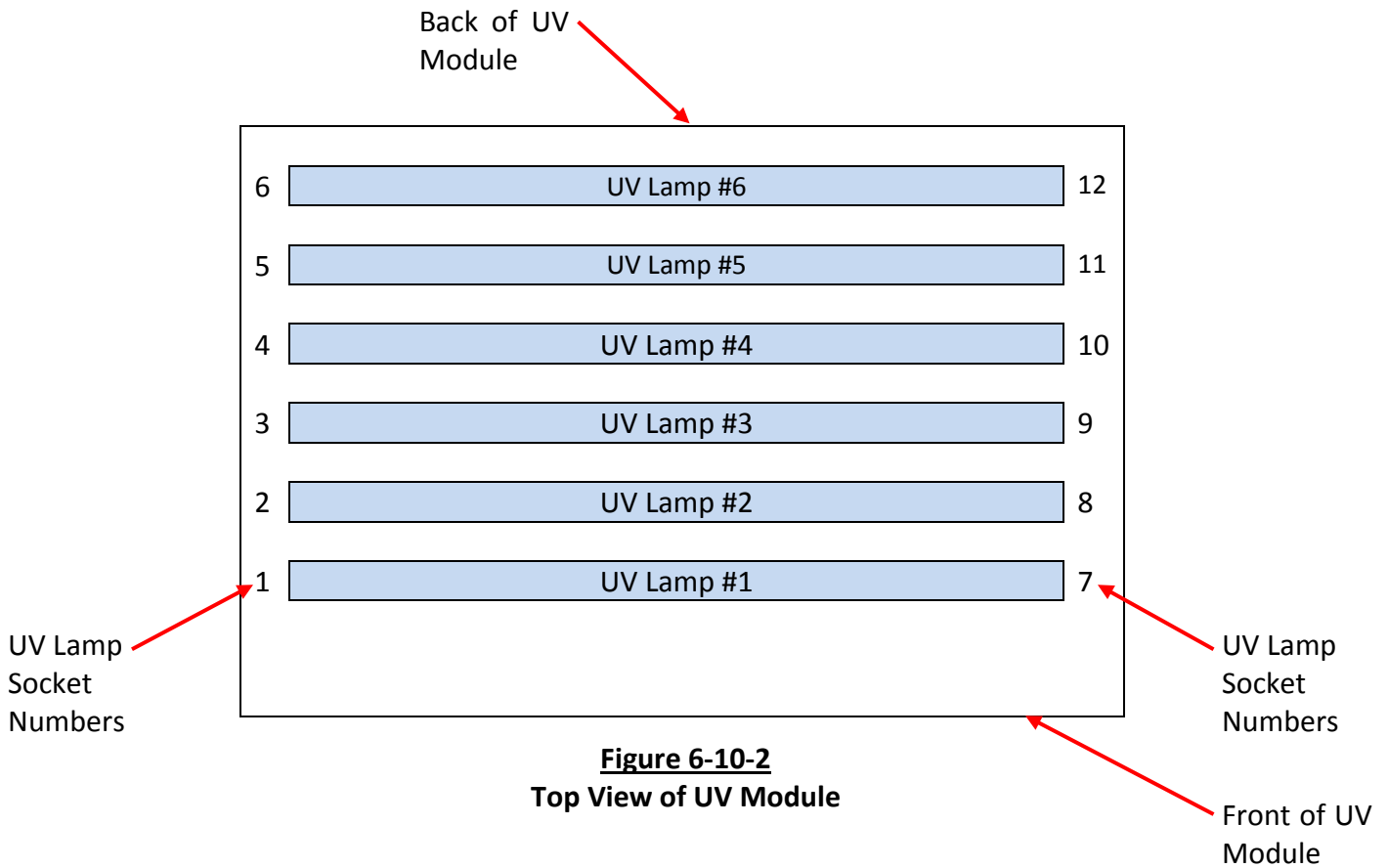

Figure 6-10-2
Top View of UV Module

Replacing UV Lamps – Cont.

9. Slide off each UV Lamp Sockets from the Lamps at each end of the Module (Refer to Figure 6-11-1).
10. Lubricate the Lamps around the Grommets on each end of the UV Lamp with a small amount of Formula G-510 or similar detergent.

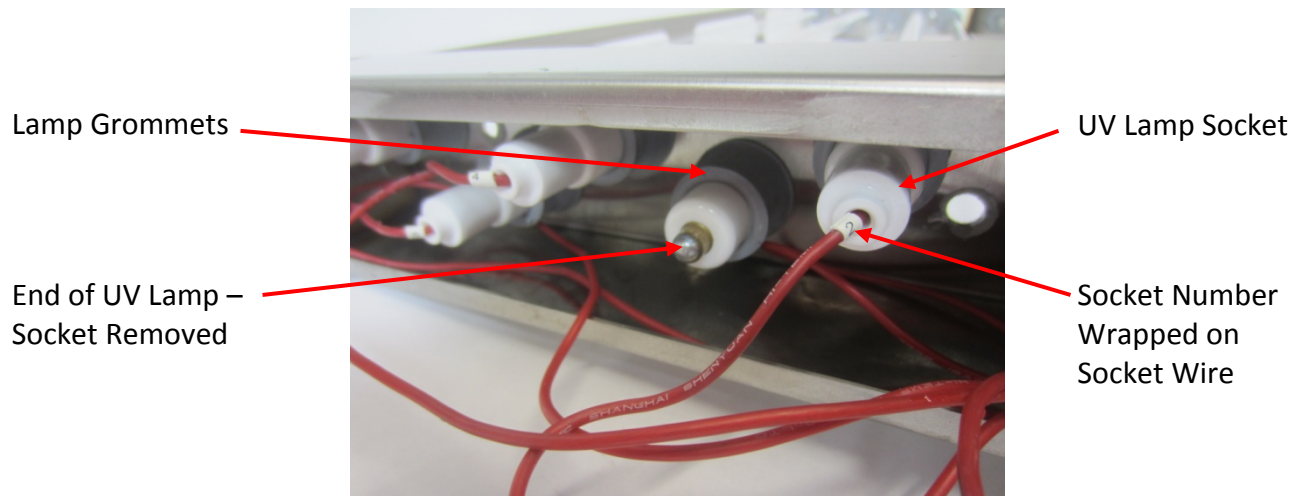

Figure 6-11-1
UV Lamp Sockets

11. CAREFULLY slide the UV Lamp out one end.
12. Inspect the Grommets around the Lamps (Refer to Figure 6-11-1). Replace any Grommet that show cracks, or any other damage.
13. Check all UV Lamp Sockets and wires for damage. Replace Lamp Sockets if the socket or wires show damage. Refer to Page 6-13 for replacement instructions.
14. Lubricate each end of the new UV Lamps before installing with a small amount of Formula G-510 or similar detergent.
15. From one end, slide in all the new UV Lamps.
16. Reconnect all the UV Lamp Sockets to the appropriate numbered Lamp as shown in Figure 6-10-2.
17. Check the Module End Cap Gaskets for cracks or deterioration (Refer to Figure 6-10-1). Replace if needed.
18. Re-install the Module End Caps with gasket and torque the bolts/nuts to 7-9 in – lbs.
19. Check the UV Module Plate Gasket for cracks or deterioration (Refer to Figure 6-12-2). Replace if needed. Refer to Page 6-41 for instructions on replacing.
20. Slide the UV Module back into the Ventilator.
21. The next step is to run a test to ensure all Lamps are operating. Secure the Module by installing one of the holding nuts at each end.

Caution: Testing the Lamps requires the use of UV protective glasses as a small amount of UV light may be visible.
22. Reconnect the Lamp / Ballast Connector plug.
23. Turn on the power to the Command Center.
24. Turn on the circuit that supplies power to the UV Lamps.

Replacing UV Lamps – Cont.

25. Push and hold in the Door Safety Switch and look at the UV Monitoring Status Board (Refer to Figure 6-8-1). There is one green light for each of the six Lamps and the light on the left is for Lamp #1 and on the right is for Lamp #6. If all the green lights are on the Lamps are operating correctly and the test is complete. If one or more lights are off, the red light will be on indicating that the wiring to that specific Lamp has a problem, such as a bad connection etc. **Caution: Always turn off the power to the Command Center and the circuit that supplies power to the UV Lamps before troubleshooting.** Troubleshoot and correct the problem and test again until all six green lights are on.
26. After all Lamps are operating properly install the eight nuts that hold the UV Module in place and torque to 7-9 inch - lbs.
27. Reconnect the Lamp / Ballast Connector plug.
28. Check the UV Module Access Door Gasket for cracks and deterioration and replace if needed. Refer to Page 6-40 for instructions on replacing.
29. Close the UV Module Access Doors.
30. Turn on all circuits that supply power to the UV Lamps.
31. Turn on power to the Gaylord Command Center.

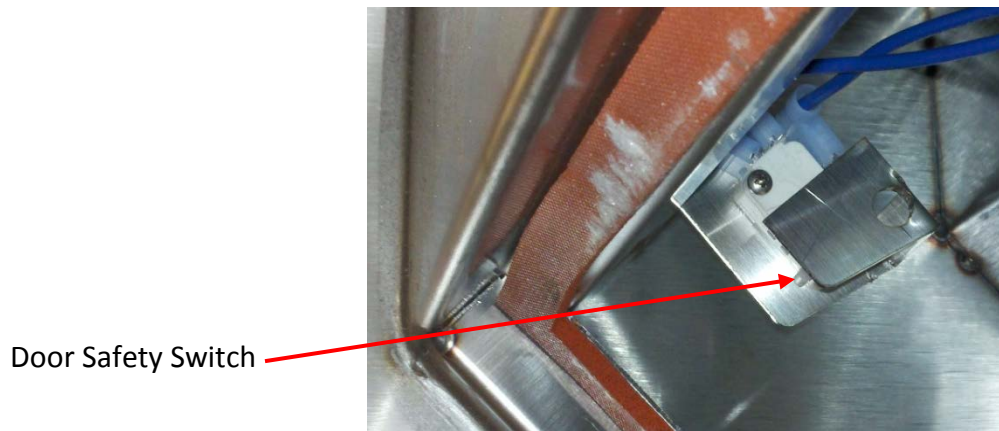

Figure 6-12-1
Door Safety Switch



Figure 6-12-2
Partial View UV Module Plate Gasket

Replacing UV Lamp Sockets

Overview

If the UV Lamp Socket or wire connected to it is damaged they must be replaced. The UV Lamp Socket and the wire come as one piece. They are not available individually. Use the following directions for replacing:

DANGER: Replacing UV Lamp Sockets as outlined on the following pages MUST be performed by a Gaylord Certified Service Agent. For a list of Gaylord Certified Service Agencies (CSA's) visit www.gaylordventilation.com and go "Service Agencies" or call Gaylord Industries at 503-691-2010.

Safety Precautions

Caution: Tasks involved in replacing UV Lamp Sockets involve potential exposure to high doses of UV light and live electrical components. There is a risk of serious injury to skin and eyes from UV light. There is a risk of shock, injury, and /or death from contact with live electrical components.

Personal Protective Equipment

1. Eye protection that prevents 100% of UV light being transmitted through the lens must be worn at all times when working on UV Lamp Modules on any CG3-UVi Ventilator that is energized and/or has the potential to be energized and expose personnel to UV light.
2. Whenever service work is performed it is recommended that long sleeve shirts and pants be worn to minimize the potential for inadvertent exposure of the skin to UV light.

Instructions for Replacing UV Lamp Sockets

To replace UV Lamp Sockets carefully use the following step by step instructions.

1. Turn off all power to the Gaylord Command Center.
2. Turn off all circuits that supply power to the UV Lamps.
3. Open the UV Module Access Door.
4. Disconnect the Lamp / Ballast Connector plug (Refer to Figure 6-9-1 and 6-9-2).
5. Remove the eight nuts that hold the Module in place.
6. Carefully slide out the UV Module and place on a work bench.
7. Next, remove the Module End Caps from each end of the Module. Using a box or open end wrench, hold the End Cap Nut on the back side of the end (Refer to Figure 6-9-3) while backing out the End Cap Bolt from the front side of the End Cap (Refer to Figure 6-9-4). There is a retainer washer on the back side of the End Cap that prevents the bolt from sliding out of the End Cap.
8. The sockets, with wires, that slide onto the ends of the UV Lamps are called UV Lamp Sockets (Refer to Figure 6-10-1). The wires are marked from the Factory with a number 1 through 6 for the left end and 7 through 12 for the right end (Refer to Figure 6-10-2 and 6-11-1).
9. Slide off each UV Lamp Sockets from the Lamps at each end of the Module (Refer to Figure 6-11-1).

Replacing UV Lamp Sockets – Cont.

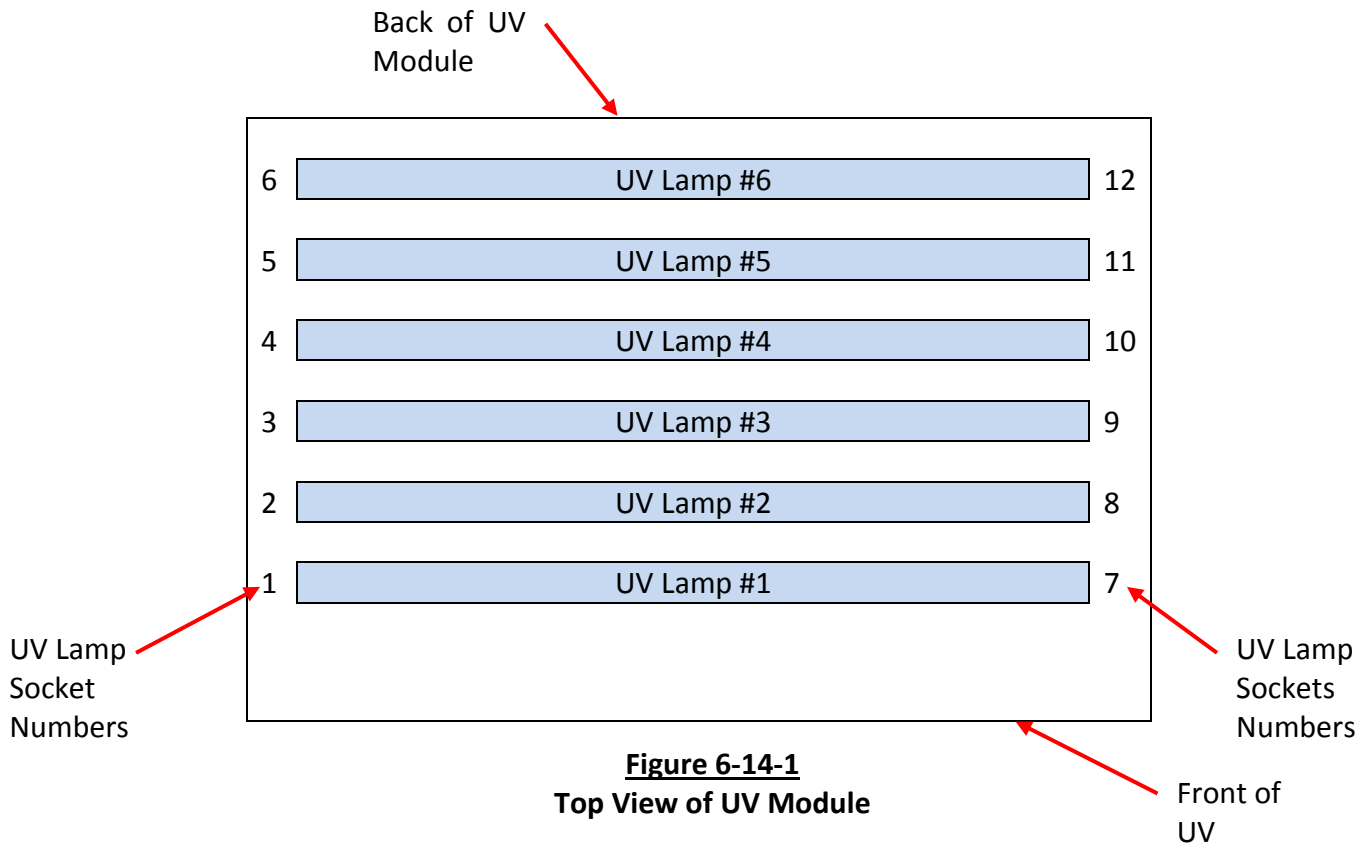

10. Next the Ballast Raceway must be removed. Using a wrench, remove the five nuts that hold the raceway to the face of the Module (Refer to Figure 6-14-2). Gently pull the Ballast Raceway off the Module as shown in Figure 6-15-1. The Ballasts are mounted to the removable Raceway (Refer to Figure 6-15-1).

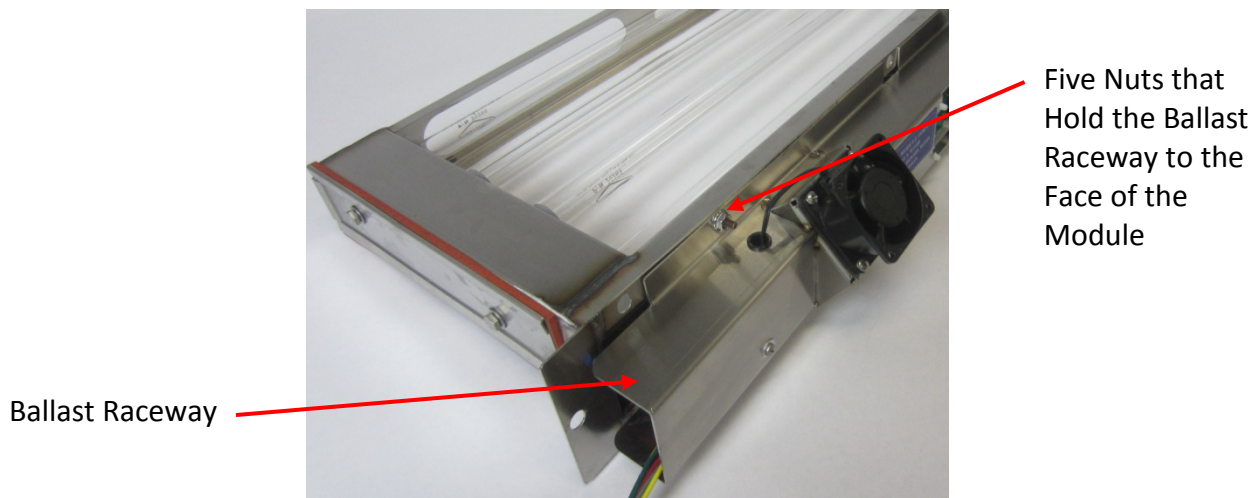

Figure 6-14-2
Removing Ballast Raceway

Replacing UV Lamp Sockets – Cont.

Explanatory Note: There are six UV Lamps and three Ballasts in an UV Module. Each Ballast serves two Lamps. The left Ballast serves Lamps #1 and #2, the middle Ballast serves Lamps #3 and #4, and the right Ballast serves Lamps #5 and #6 (Refer to Figure 6-14-1 and 6-15-1).

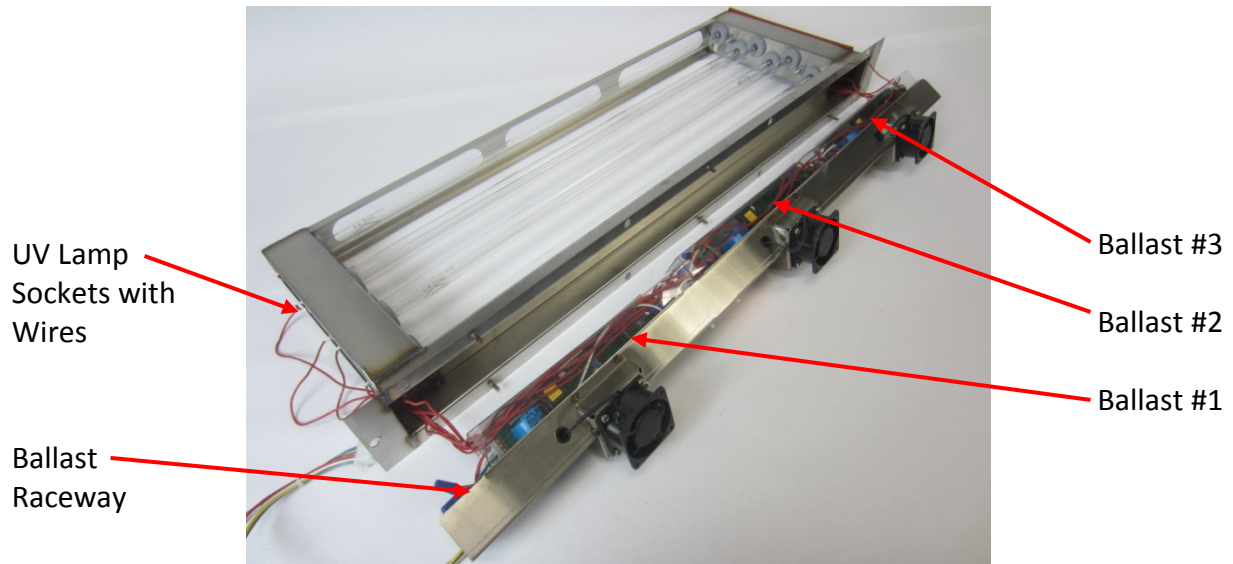

Figure 6-15-1
Ballast Raceway Removed from Module

11. Remove the two Ballast Holding Screws, with washers, for each Ballast for which the UV Lamp Sockets need replacement (Refer to Figure 6-15-2).

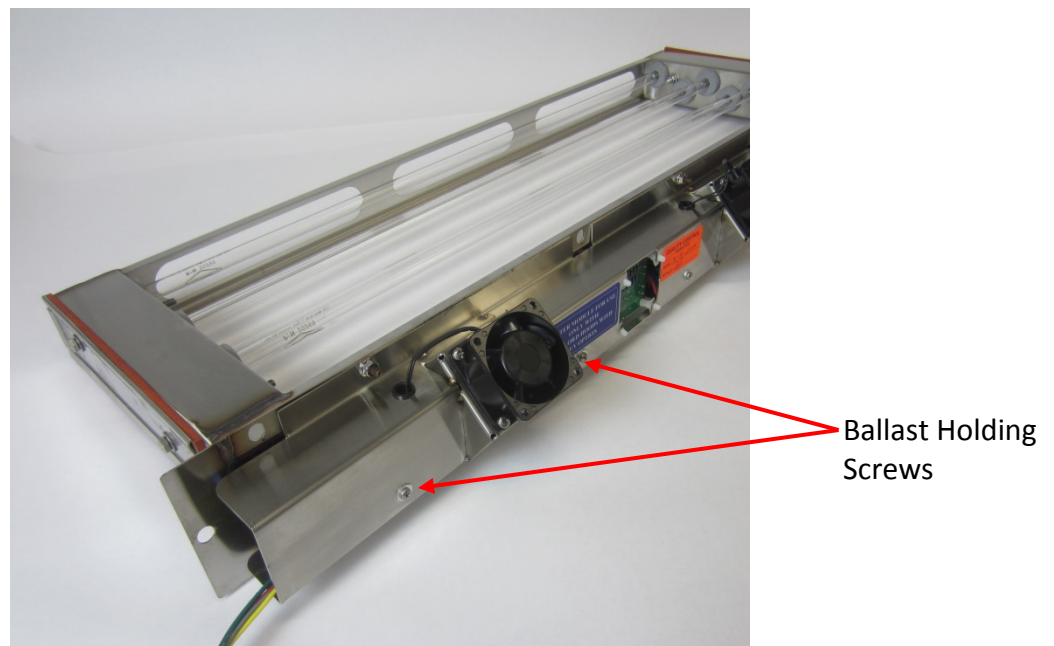

Figure 6-15-2
Ballast Holding Screws

Replacing UV Lamp Sockets – Cont.

12. Pull the Ballast away from the Raceway and rotate so the Ballast is facing you (Refer to Figure 6-16-1).

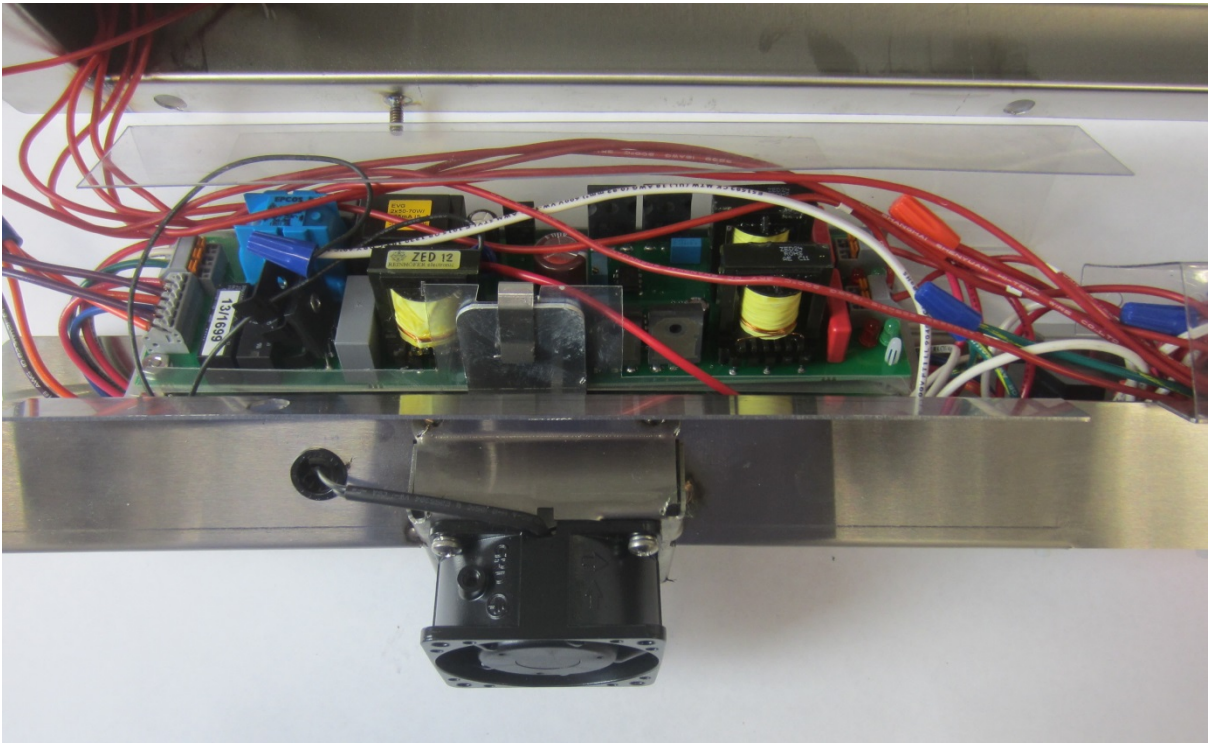
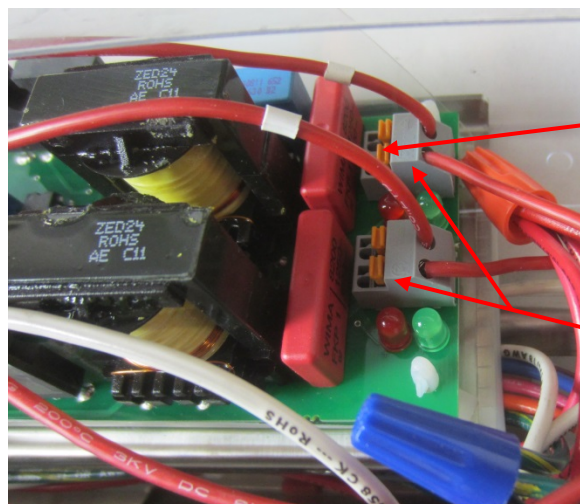

Figure 6-16-1
Ballast Rotated Up

Explanatory Note: Each Ballast has two pairs of Lamp terminals (Refer to Figure 6-16-2). Each pair serves one Lamp, with one wire going to the left end and the other going to the right. The terminals are wired to the appropriate lamp as show in Figure 6-14-1.

13. Disconnect each wire that needs replacement by using a small screwdriver and pushing down on the small orange release tab and then pulling straight up on the wire (Refer to Figure 6-16-2).



Orange Release
Tabs

Two Pairs of
Terminals

Figure 6-16-2
Ballast Lamp Terminals

Replacing UV Lamp Sockets – Cont.

14. Pull all the disconnected Lamp Sockets with wire from the Module.
15. Each pulled wire has a wrapped number on each end. As an example the wire for Lamp #1 will have one wire with the #1 on each end for the left end of the Lamp and one wire with the #7 on each end for the right end of the Lamp (Refer to Figure 6-14-1 and 6-17-2). The replacement Lamp Sockets with wire come in a standard length, long enough to reach the furthest point. Using the old wire as a guide cut the new wire the same length.
16. Strip 1/4" off the end of the wire.
17. Using number wraps, mark the wires at each end with the appropriate number.
18. Insert all the wires through the appropriate ends of the Module and through the Module End Wire Way that leads to the Ballast Raceway (Refer to Figure 6-17-1)

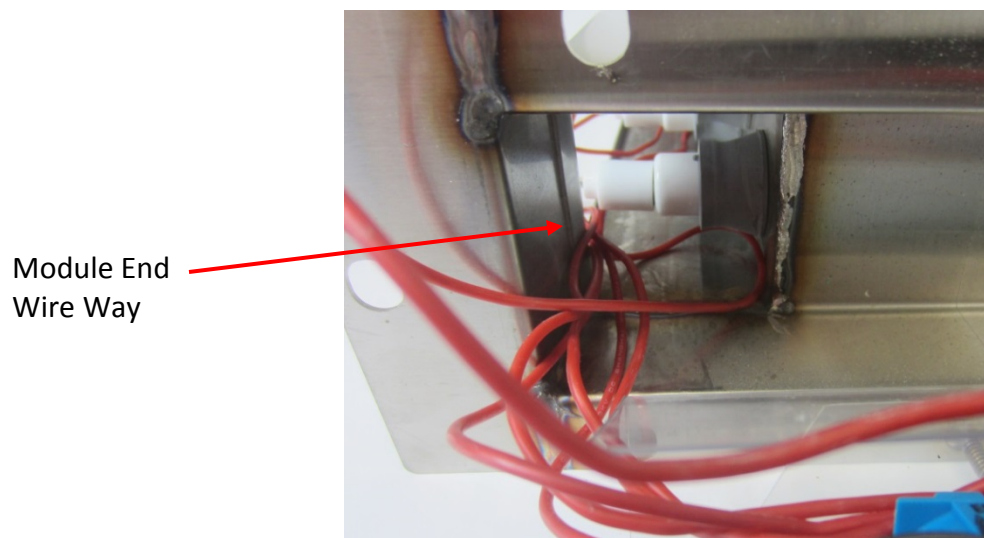

Figure 6-17-1
Module End Wire Way

19. Using Figure 6-17-2 as a guide, rout all the wires over to the appropriate terminal.
20. Using a small screwdriver push down on the small orange tab, insert the wire and release the tab. (Refer to Figure 6-16-2).

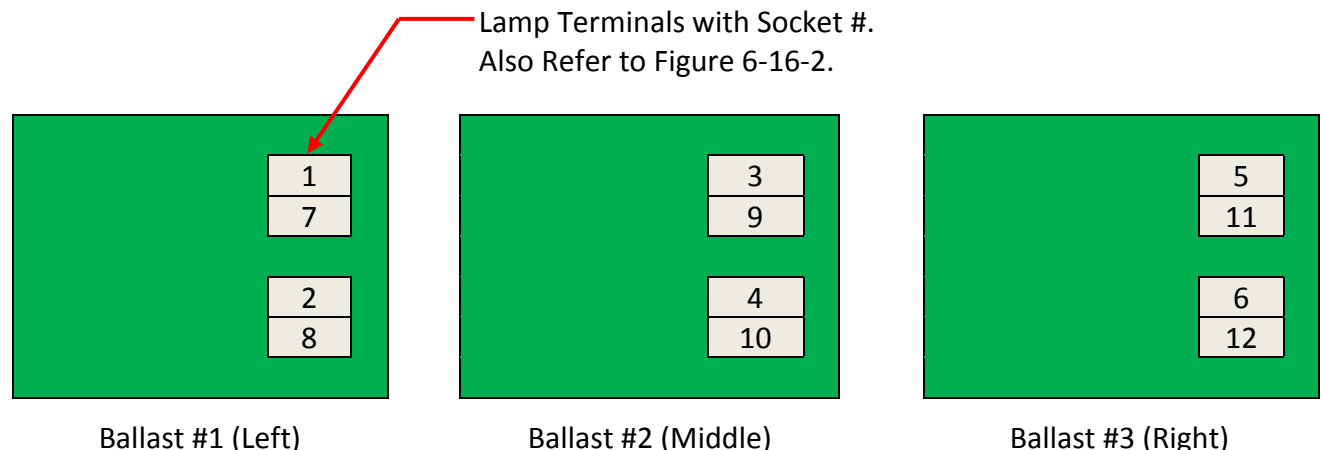

Figure 6-17-2
Illustration of Ballast and Lamp Terminal Connection Points

Replacing UV Lamp Sockets – Cont.

21. Place the Ballast back into the Ballast Raceway and secure with the two screws and washers. Torque to 7-9 in-lbs.
22. Reconnect all the UV Lamp Sockets to the appropriate numbered Lamp as shown in Figure 6-14-1.
23. Install the Ballast Raceway to the face of the Module with the five nuts and washers and torque to 7-9 in – lbs.
24. Check the Module End Cap Gaskets for cracks or deterioration. Replace if needed.
25. Install the Module End Caps with gasket and torque the bolts/nuts to 7-9 in – lbs.
26. Check the UV Module Plate Gasket for cracks or deterioration (Refer to Figure 6-41-1). Replace if needed. Refer to Page 6-41 for instructions on replacing.
27. Slide the UV Module back into the Ventilator.
28. The next step is to run a test to ensure all Lamps are operating. Secure the Module by installing one of the holding nuts at each end.

Caution: Testing the Lamps requires the use of UV protective glasses as a small amount of UV light may be visible.

29. Reconnect the Lamp / Ballast Connector plug.
 30. Turn on the power to the Command Center.
 31. Turn on the circuit that supplies power to the UV Lamps.
 32. Push and hold in the Door Safety Switch (Refer to Figure 6-18-1) and look at the UV Monitoring Status Board (Refer to Figure 6-19-1). There is one green light for each of the six Lamps and the light on the left is for Lamp #1 and on the right is for Lamp #6. If all the green lights are on the UV Lamps are operating correctly and the test is complete. If one or more lights are off, the red light will be on indicating that the wiring to that specific Lamp has a problem, such as a bad connection etc.
- Caution: Always turn off the power to the Command Center and the circuit that supplies power to the UV Lamps before troubleshooting.** Troubleshoot and correct the problem and test again until all six green lights are on.

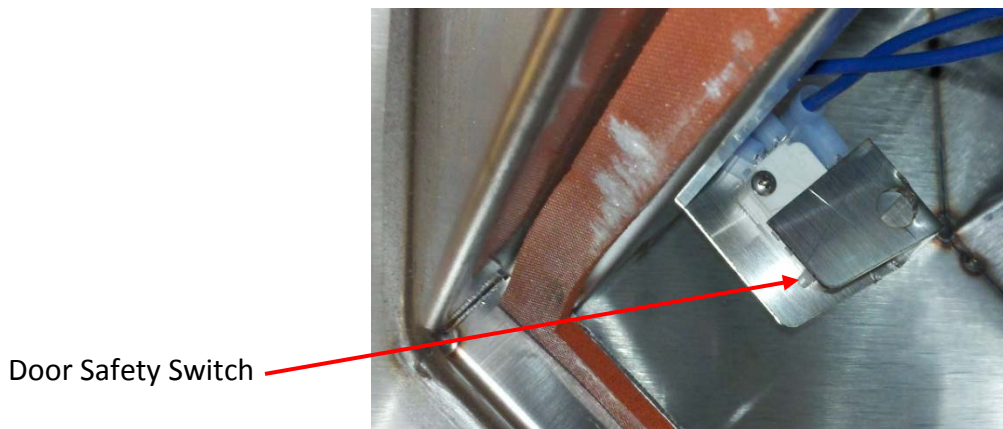

Figure 6-18-1
Door Safety Switch

Replacing UV Lamp Sockets – Cont.

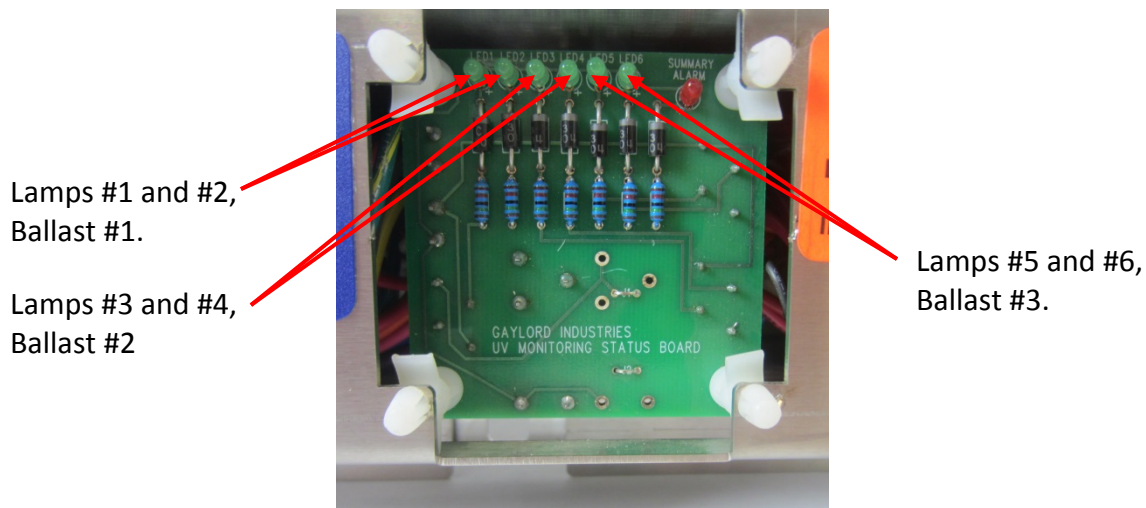

Figure 6-19-1
UV Monitoring Status Board

33. Once the testing is complete install the remaining nuts that hold the UV Module in place and torque all five nuts to 7-9 in - lbs.
34. Reconnect the Lamp / Ballast Connector plug.
35. Close the UV Module Access Doors.
36. Turn on all circuits that supply power to the UV Lamps.
37. Turn on power to the Gaylord Command Center.

Replacing UV Ballast

DANGER: Replacing UV Ballasts as outlined on the following pages **MUST** be performed by a Gaylord Certified Service Agent. For a list of Gaylord Certified Service Agencies (CSA's) visit www.gaylordventilation.com and go "Service Agencies" or call Gaylord Industries at 503-691-2010.

Safety Precautions

Caution: Tasks involved in replacing UV Ballasts involve potential exposure to high doses of UV light and live electrical components. There is a risk of serious injury to skin and eyes from UV light. There is a risk of shock, injury, and /or death from contact with live electrical components.

Personal Protective Equipment

1. Eye protection that prevents 100% of UV light being transmitted through the lens must be worn at all times when working on UV Lamp Modules on any CG3-UVi Ventilator that is energized and/or has the potential to be energized and expose personnel to UV light.
2. Whenever service work is performed it is recommended that long sleeve shirts and pants be worn to minimize the potential for inadvertent exposure of the skin to UV light.

Replacing UV Ballast – Cont.

Overview

There are three Ballasts in an UV Module. Each Ballast serves two lamps. The left Ballast serves Lamps #1 and #2, the middle Ballast serves Lamps #3 and #4, and the right Ballast serves Lamps #5 and #6 (Refer to Figure 6-14-1 and 6-15-1). There are a maximum of two UV Modules in one Ventilator section (Refer to Table T-6-7-1. If one or more Ballast has failed, in the group of SYSTEM STATUS lights mounted on the Ventilator, the UVi SYSTEM ON green light and the UVi LAMP FAILURE yellow light will be on indicating one or more Ballast(s) must be replaced (Refer to Figure 4-4-1).

How to Determine Which Ballast is Defective

To determine which Ballast is defective, proceed as follows:

1. Turn on the power to the Command Center.
2. Turn on the circuit that supplies power to the UV Lamps.
3. Push the **START FAN** button on the Command Center.
4. Open the UV Module Access Door(s).
5. Push and hold in the Door Safety Switch (Refer to Figure 6-21-1) and look at the UV Monitoring Status Board on each Module (Refer to Figure 6-20-1). There is one green light for each of the six Lamps and the light on the left is for Lamp #1 and on the right is for Lamp #6. If for example green lights for lamps #1 and #2 are off, most likely the left Ballast, Ballast #1 is defective. If light #3 and #4 are off Ballast #2 is defective, and lights #5 and #6 are off Ballast 3 is defective. Whenever one or more green lights are off, the red light will be on.
6. After determining which Ballast is defective, replace using the instructions beginning on page 6-22.

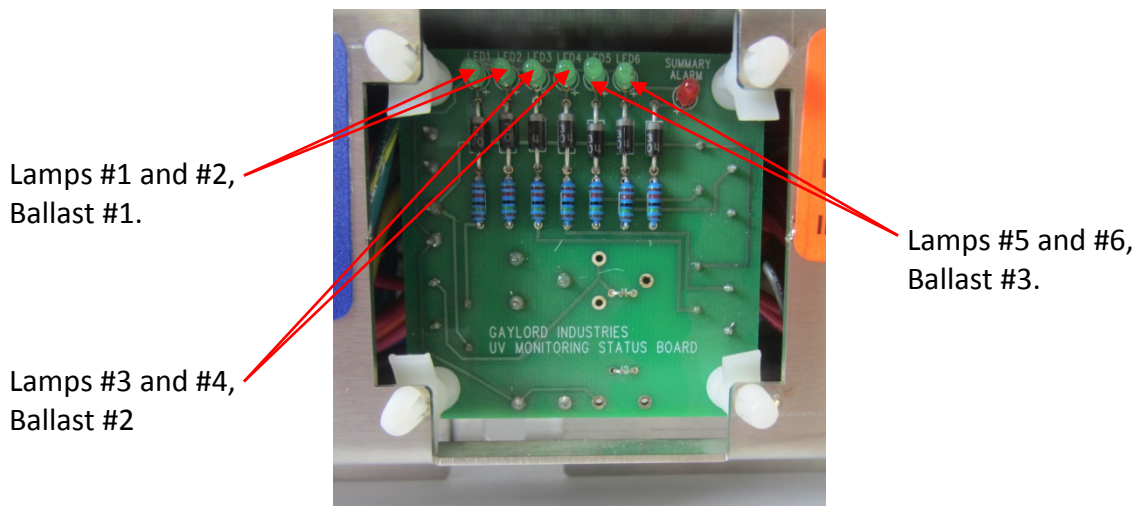

Figure 6-20-1
UV Monitoring Status Board

Replacing UV Ballast –Cont.

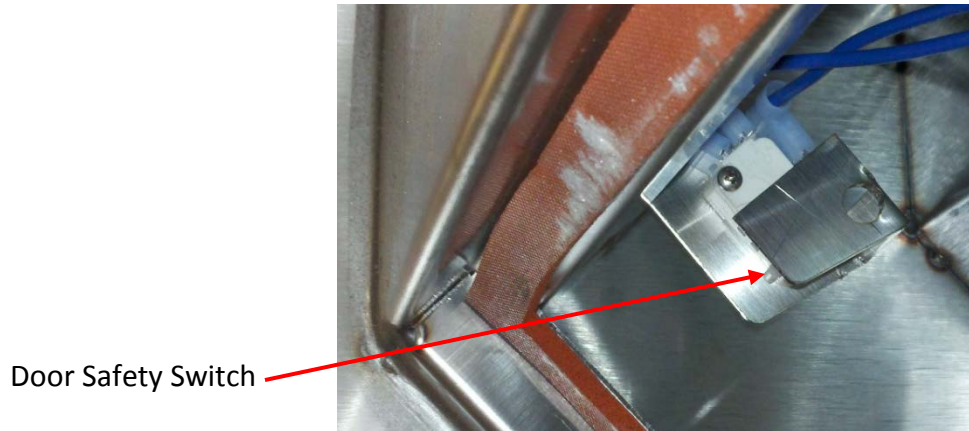

Figure 6-21-1
Door Safety Switch

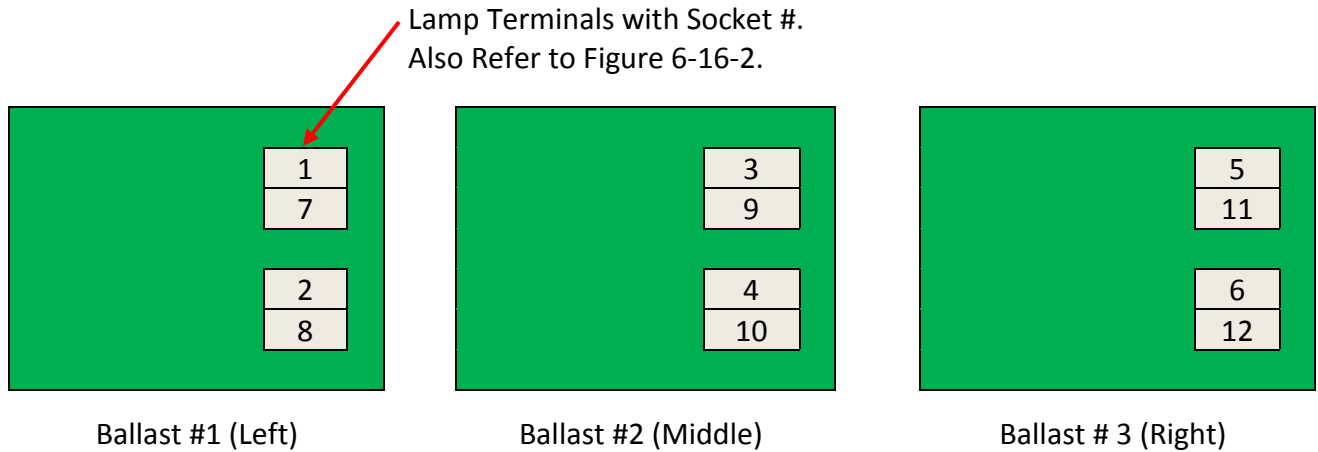

Figure 6-21-2
Illustration of Ballast and Lamp Terminal Connection

Replacing UV Ballast –Cont.

Instructions for Replacing UV Ballasts

To replace UV Lamp Sockets carefully use the following step by step instructions.

1. Turn off all power to the Gaylord Command Center.
2. Turn off all circuits that supply power to the UV Lamps.
3. Open the UV Module Access Door.
4. Disconnect the Lamp / Ballast Connector plug (Refer to Figure 6-9-1 and 6-9-2).
5. Remove the eight nuts that hold the Module in place.
6. Carefully slide out the UV Module and place on a work bench.
7. Next the Ballast Raceway must be removed. Using a wrench, remove the five nuts that hold the raceway to the face of the Module (Refer to Figure 6-22-1). Gently pull the Ballast Raceway off the Module as shown in Figure 6-22-2.

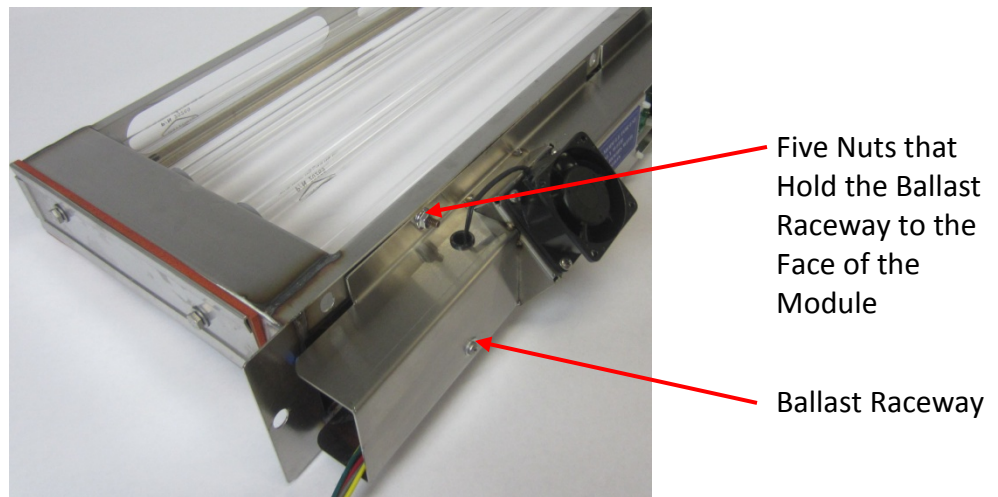

Figure 6-22-1
Removing Ballast Raceway

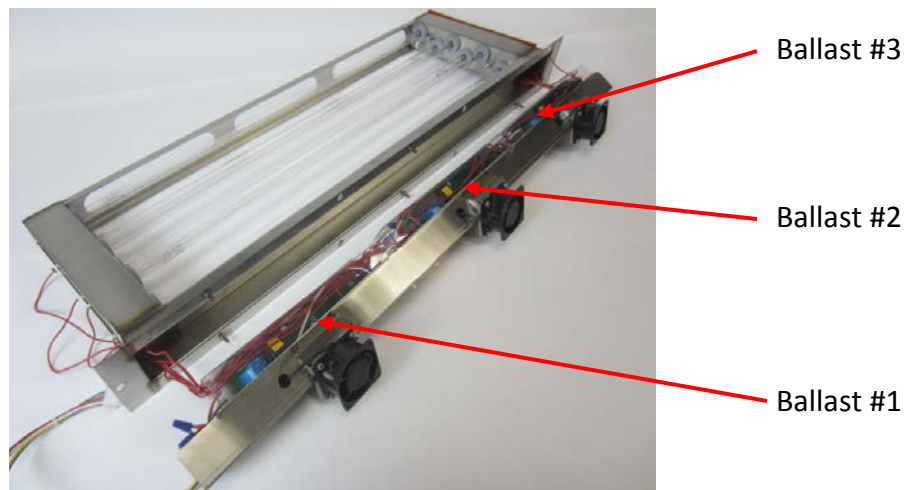

Figure 6-22-2
Ballast Raceway Removed from Module

Replacing UV Ballast –Cont.

8. Remove the two Ballast Holding Screws, for the Ballast that needs replacing, that hold the Ballast to the Ballast Raceway (Refer to Figure 6-23-1)

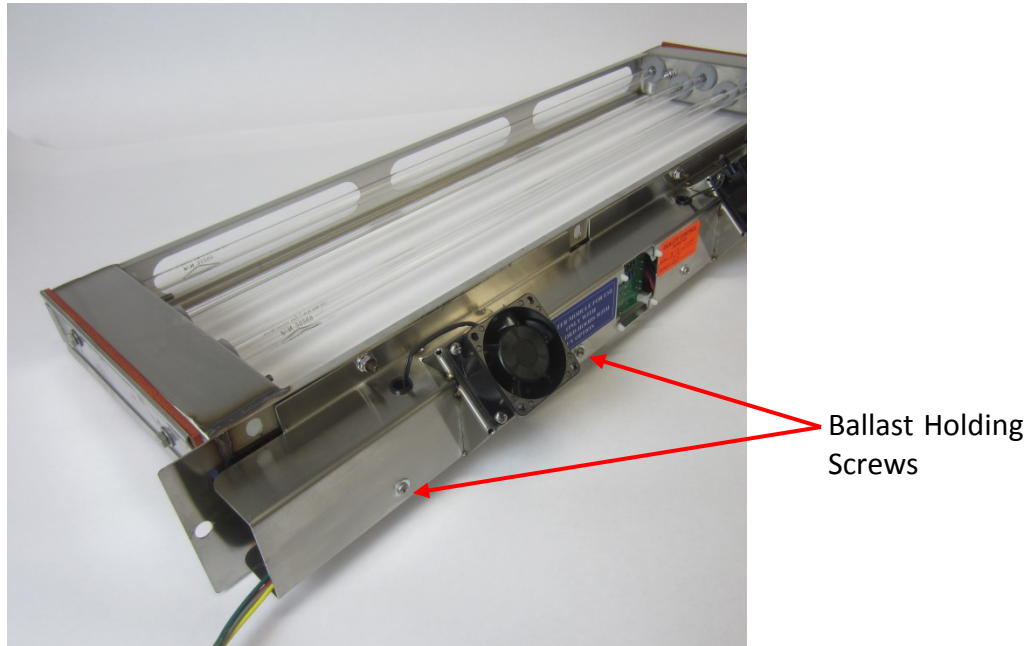

Figure 6-23-1
Ballast Holding Screws

9. Pull the Ballast away from the Raceway and rotate so the Ballast is facing up (Refer to Figure 6-23-2).

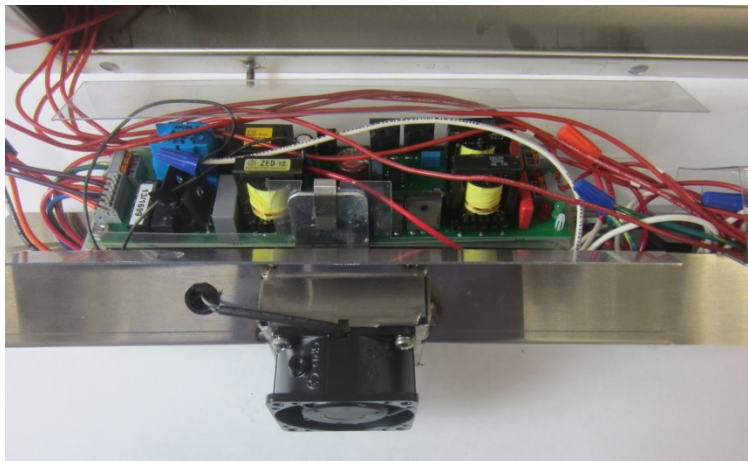

Figure 6-23-2
Ballast Rotated Up

Replacing UV Ballast –Cont.

10. Remove the four Lamp wires from the Lamp terminals on the right end of the Ballast by using a small screwdriver and pushing down on the small orange release tabs and then pulling straight up on the wire (Refer to Figure 6-24-1). **Important Note: Do not remove any of the wires from the terminals at the left end at this time.**

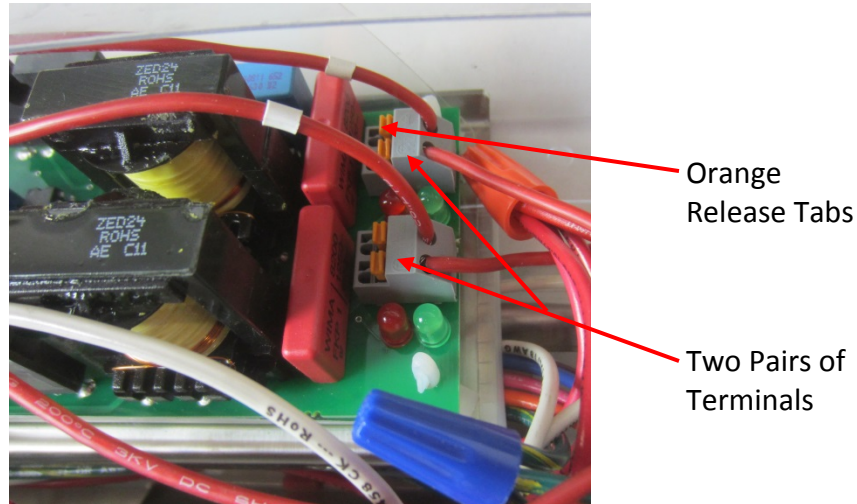

Figure 6-24-1
Ballast Lamp Terminals

11. Disconnect the two black wires going to the Module Ventilation Fan. Put the wire nuts back on the colored wire as a marker to reconnect the fan.
12. Carefully lift the Ballast out of the Raceway and place on the work table (Refer to Figure 6-24-2).
13. Remove the spring clip located in the front center of the Ballast (Refer to Figure 6-24-2).

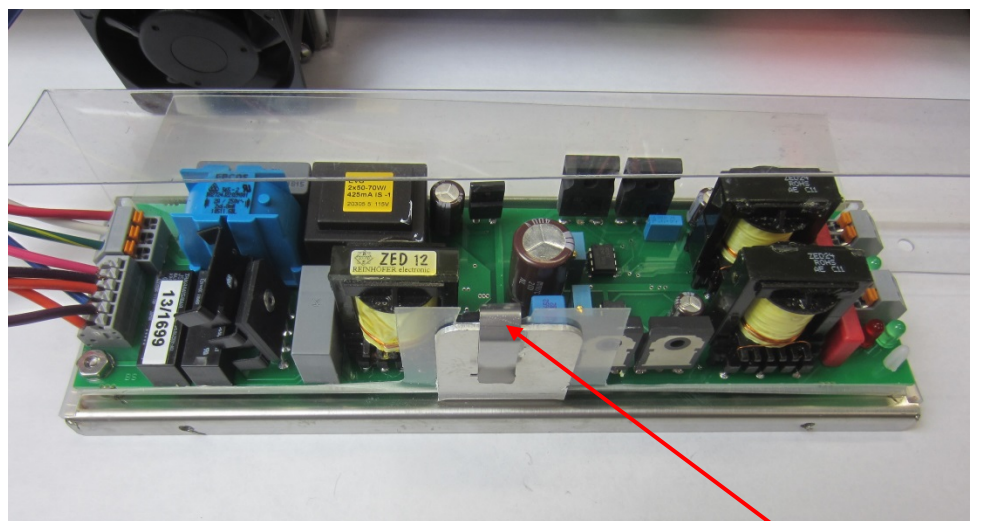

Figure 6-24-2
Ballast

Replacing UV Ballast –Cont.

14. In the bottom left corner of the Ballast remove the holding nut (Refer to Figure 6-25-1).

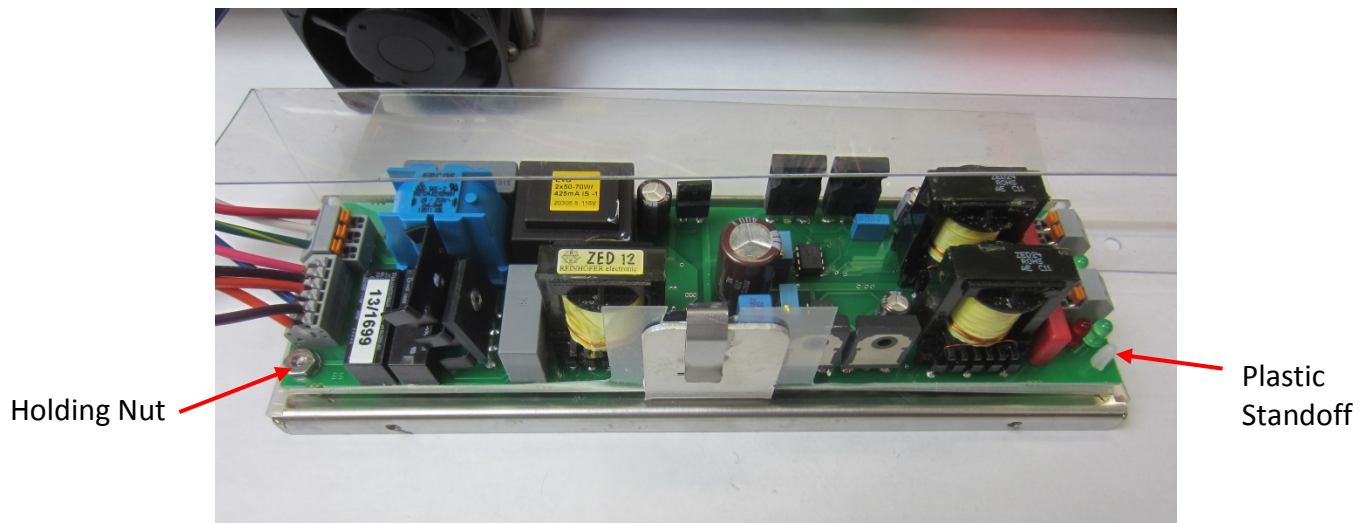

Figure 6-25-1
Module Removed from Raceway

15. On each plastic standoff that supports the remaining three points of the Ballast, use a screw driver or needle nose pliers and push in on the holding tab while prying up on the Ballast (Refer to Figure 6-25-1). Once the Ballast is loose from the Ballast chassis, place the chassis to one side and place the Ballast in front of the Raceway as shown in Figure 6-25-2

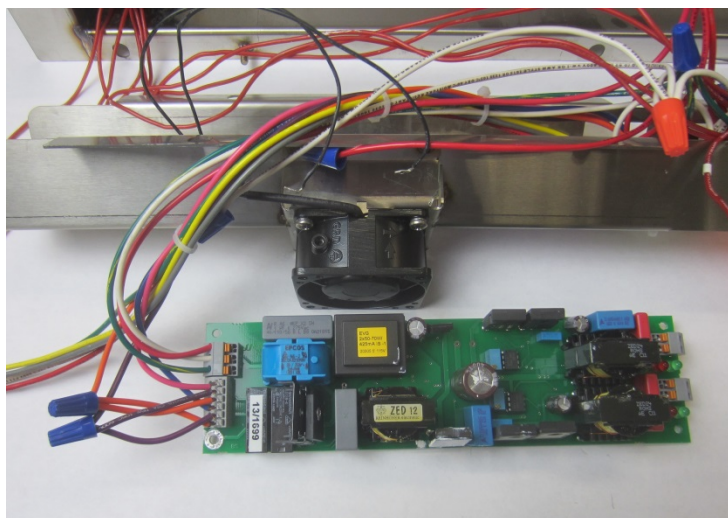

Figure 6-25-2
Ballast Removed from Chassis

Replacing UV Ballast –Cont.

16. Next the wires from the terminals at the left end of the old Ballast must be transferred to the new Ballast. Place the new Ballast in front of the old Ballast as shown in Figure 6-26-1.

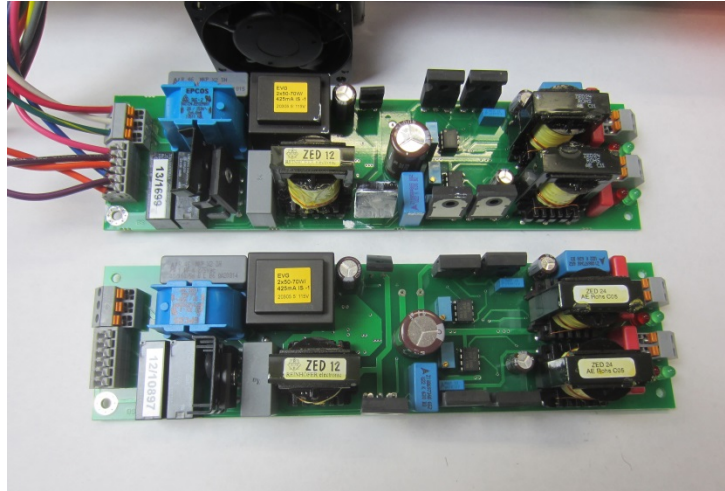

Figure 6-26-1
New Ballast in front of Old Ballast

17. It is recommended that one wire at a time be removed and inserted into the terminal of the new Ballast. If you are viewing this manual in color, use the photo in Figure 6-26-2 to assist in placing the right colored wire into the correct terminal. If you are viewing this manual in black and white, it is highly recommended that a close up photo be taken. Also, Figure 6-27-1 shows the color of wire for each terminal.

Remove and reconnect each wire by using a screwdriver and pushing down on the release tabs.

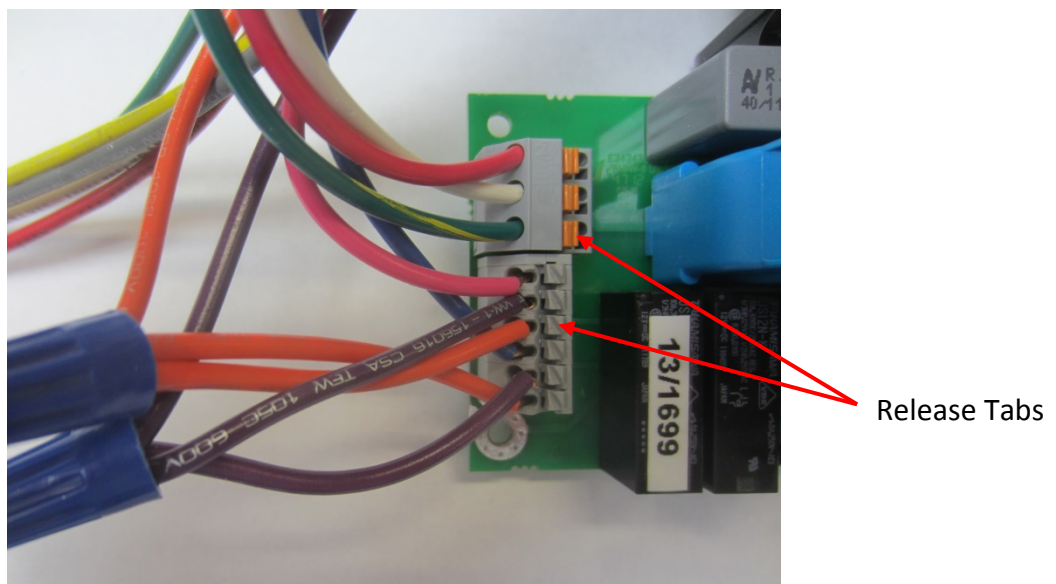

Figure 6-26-2
Wire Terminal at Left End of Ballast

Replacing UV Ballast – Cont.

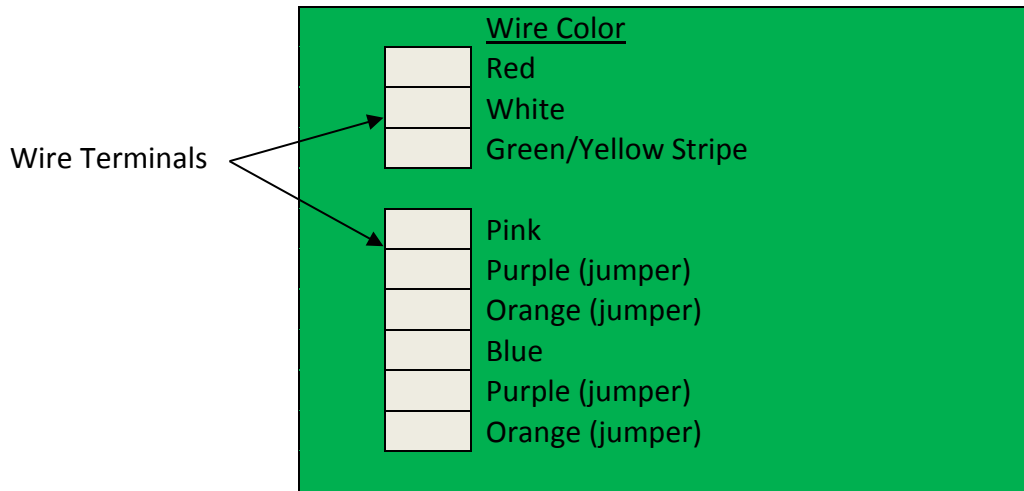

Figure 6-27-1
Ballast Terminal Wire Color

18. Once all the wires at the left end have been connected, the new Ballast can be installed on the Ballast Chassis. **Important Note:** before installing, spread a small amount of thermal transfer grease (provided with new Ballasts) on the side of the center heat sink as shown in Figure 6-27-2. When installing back into the chassis, make sure the plastic tab is between the heat sink and the aluminum angle on the chassis (Refer to Figure 6-28-1 and 6-28-2. Then slip the Ballast onto the three standoffs and the stud at the bottom left, and push down until the Ballast snaps into place.

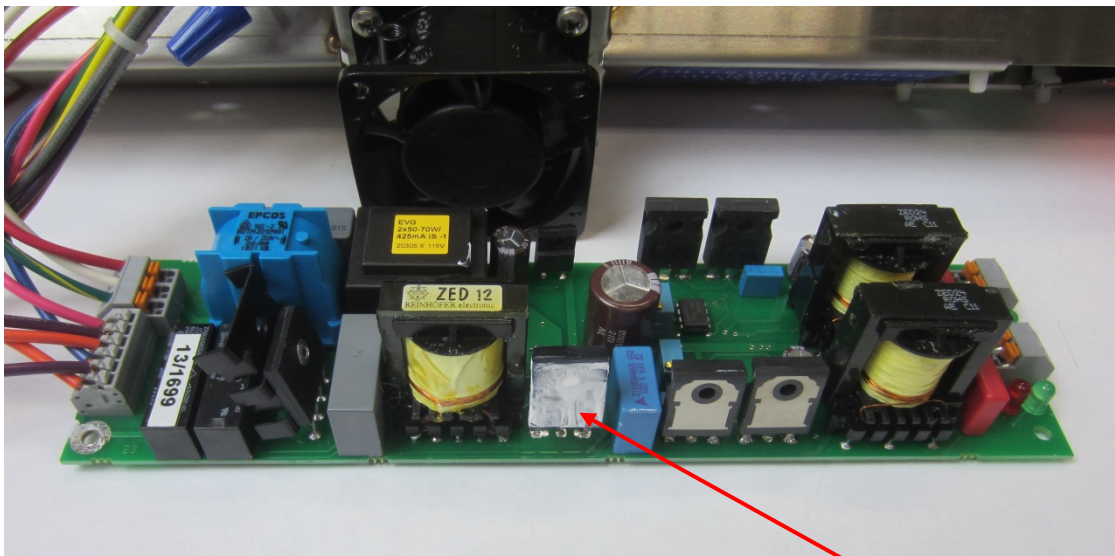
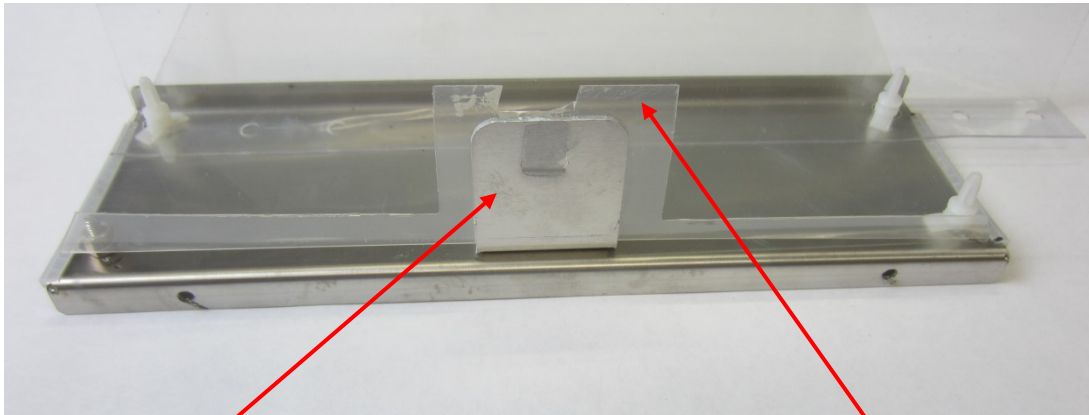

Figure 6-27-2
Applying Thermal Transfer Grease

Apply Thermal Transfer Grease To The Heat Sink Here

Replacing UV Ballast – Cont.



Aluminum
Angle

Figure 6-28-1
Ballast Chassis

Plastic Tab

19. Install the holding nut at the bottom left and tighten to 7-9 in-lbs. (Refer to Figure 6-28-2).
20. Install the spring clip over the center heat sink and aluminum angle (Refer to Figure 6-28-2).

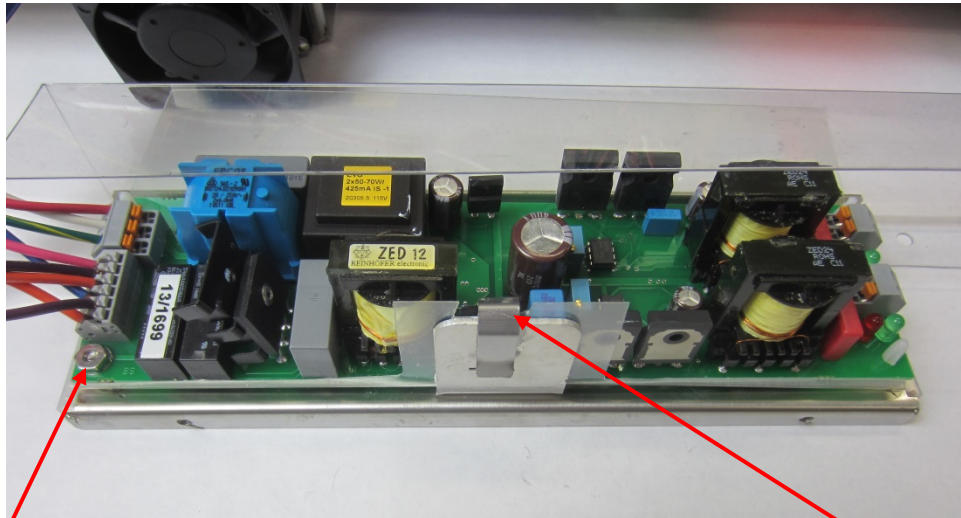

Holding Nut

Figure 6-28-2
Ballast Mounted on Chassis

Spring Clip

21. Carefully rotate the Ballast back into the Ballast Raceway, align the mounting holes, install the Ballast Holding Screws and washers, and torque to 7-9 in-lbs.
22. Reconnect the Cooling Fan wires.

Replacing UV Ballast – Cont.

23. The Lamp wires are numbered. Install the Lamp wires back into the appropriate terminal using Figure 6-29-1 as a guide.

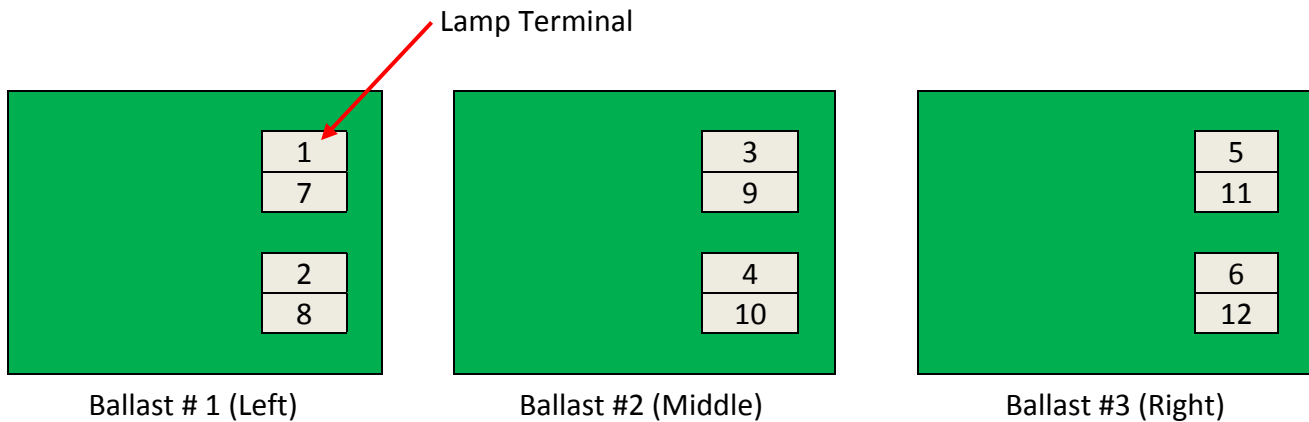

Figure 6-29-1
Illustration of Ballast and Lamp Terminal Connections Points

24. Install the Ballast Raceway to the face of the Module with the five nuts and washers and torque to 7-9 in – lbs.
25. Check the UV Module Plate Gasket for cracks or deterioration (Refer to Figure 6-41-1). Replace if needed. Refer to Page 6-41 for instruction on replacing.
26. Slide the UV Module back into the Ventilator.
27. The next step is to run a test to ensure all Lamps are operating. Secure the Module by installing one of the holding nuts at each end.

Caution: Testing the Ballasts requires the use of UV protective glasses as a small amount of UV light may be visible.
28. Reconnect the Lamp / Ballast Connector plug.
29. Turn on the power to the Command Center.
30. Turn on the circuit that supplies power to the UV Lamps.
31. Push and hold in the Door Safety Switch and look at the UV Status Light Board (Refer to Figure 6-20-2). There is one green light for each of the six Lamps and the light on the left is for Lamp #1 and on the right is for Lamp #6. If all the green lights are on the Ballast is operating correctly the test is complete. If two lights are off, the Ballast for those lamps is not operating properly. **Caution: Always turn off the power to the Command Center and the circuit that supplies power to the UV Lamps before troubleshooting.** Troubleshoot and correct the problem and test again until all six green lights are on.
32. Once the testing is complete install the remaining nuts that hold the UV Module in place and torque all five nuts to 7-9 in - lbs.
33. Reconnect the Lamp / Ballast Connector plug.
34. Close the UV Module Access Doors.
35. Turn on all circuits that supply power to the UV Lamps.
36. Turn on power to the Gaylord Command Center.

Main Electrical Raceway Ventilation Fan

Overview

The Main Electrical Raceway Ventilation Fan is located at the right end of each Ventilator section behind the Main Electrical Raceway Access Panel (Refer to Figure 6-30-1 and 6-31-1). The purpose of the Ventilation Fan is to pull air into the raceway to; 1) help cool the raceway, 2) provide air to the UV Module Ventilation Fans and 3) to slightly pressurize the raceway to prevent grease from migrating into the area. The fan pulls air through a Ventilation Snorkel located immediately above the fan and the air is discharged through an opening with a Ventilation Snorkel at the left end of the raceway. The Ventilation Snorkel helps prevent building insulation and other debris from obstruction airflow.

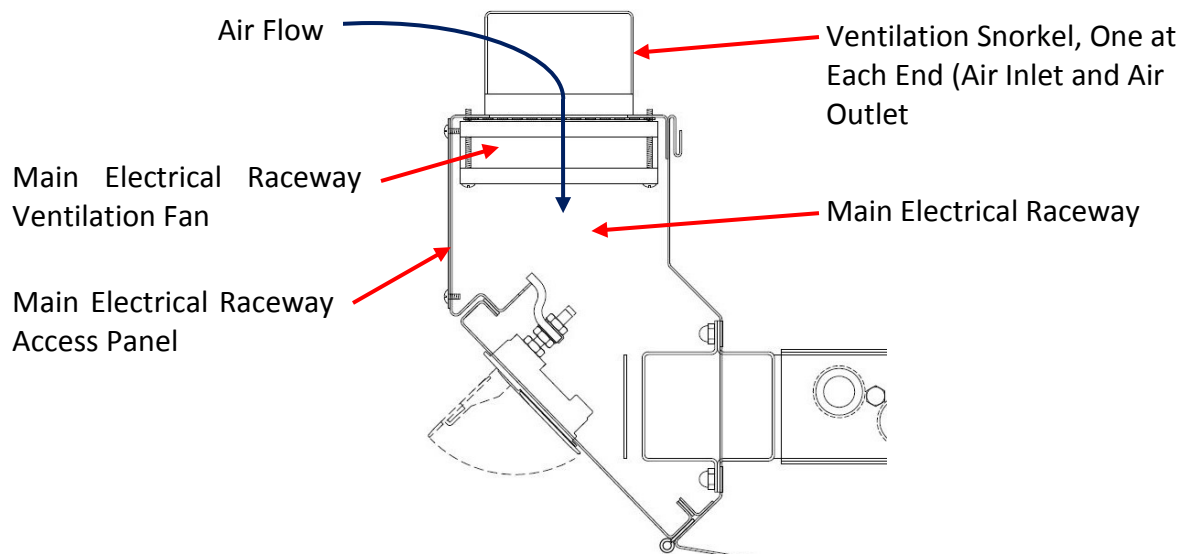

Figure 6-30-1
Section View Main Electrical Raceway

Checking the Main Electrical Raceway Ventilation Fan

The Ventilation Fan runs anytime the UV System is on. To check for proper operation proceed as follows:

1. Push the **START FAN** button on the Command Center. Check to make sure the green light on the group of UVi Status Lights mounted on the Ventilator section is on.
2. Remove the Main Electrical Raceway Access Panel at the right end of the Ventilator (Refer to Figure 6-31-1).
3. Observe the Ventilation Fan operating. If operating, reinstall the access panel and tighten the screws to 7-9 in-lbs. If not operating conduct an electrical test at the connection points for voltage. If there is voltage, the Ventilation Fan is defective and must be replaced.

Instructions for Replacing the Main Electrical Raceway Ventilation Fan

To replace Ventilation Fan use the following step by step instructions:

1. Turn off all power to the Gaylord Command Center.
2. Turn off all circuits that supply power to the UV Lamps.

Main Electrical Raceway Ventilation Fan – Cont.

3. Remove the Main Electrical Raceway Access Panel at the right end of the Ventilator (Refer to Figure 6-31-1).
4. Unplug the electrical connections at the top left corner of the fan (Refer to Figure 6-31-2).



Main Electrical Raceway
Access Panel

UV Module Access
Door Gasket

Figure 6-31-1
Main Electrical Raceway
Access Panel

5. Sliding a small screwdriver through the front flange, remove the four fan mounting screws (Refer to Figure 6-31-2).

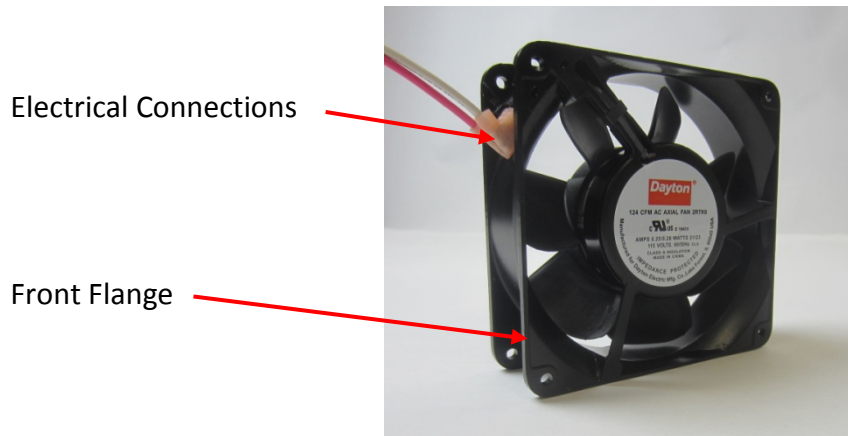

Electrical Connections

Front Flange

Figure 6-31-2
Main Electrical Raceway

6. Before installing the new fan check the Ventilation Snorkel for any obstructions.
7. Install the new fan with the label facing you and torque the screws to 7-9 in-lbs.
8. Plug in the electrical connection.
9. Turn on the power to the Command Center and the UV Lamps.
10. Push the **START FAN** button and check the Ventilation fan for proper air flow direction (Refer to Figure 6-30-1).
11. If operating properly reinstall the Access Panel and torque the screws to 7-9 in-lbs.

UV Module Ventilation Fans

Overview

There are three UV Module Ventilation Fans mounted on each UV Module (Refer to Figure 6-32-1). The purpose of the Ventilation Fans is to push air into the UV Ballast Raceway to help it cool. The fans push air into the raceway and the air then discharged through the openings at each end of the raceway.

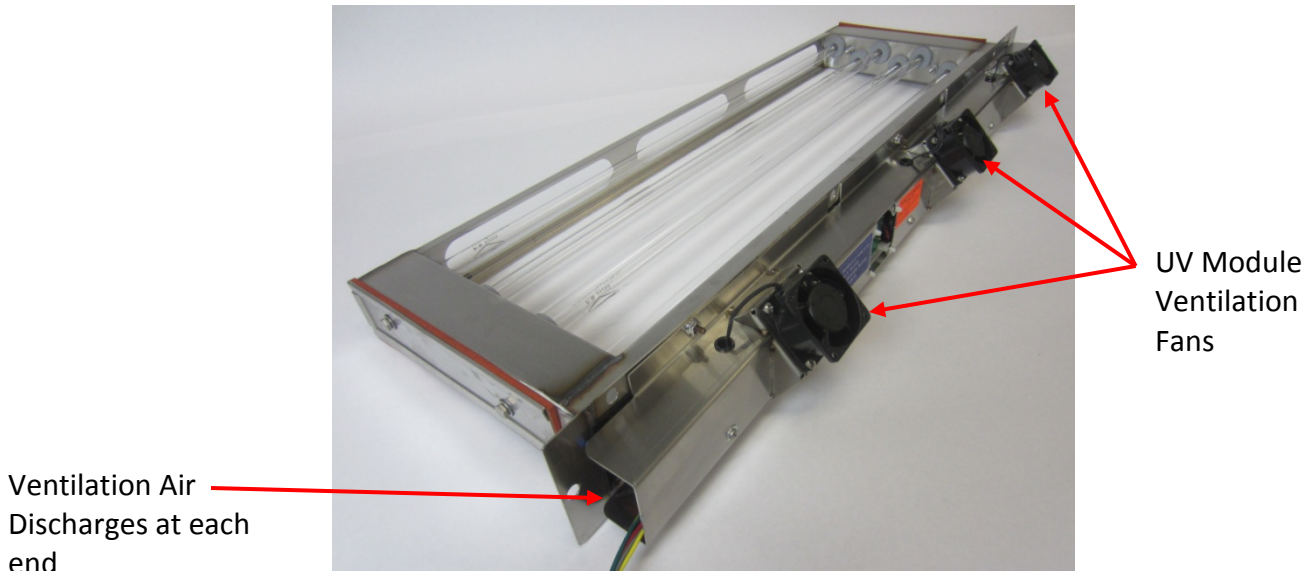

Figure 6-32-1
Typical UV Module

Checking the UV Module Ventilation Fans

The Ventilation Fans run anytime the UV system is on. To check for proper operation proceed as follows:

Caution: Testing the UV Module Ventilation Fans requires the use of UV protective glasses as a small amount of UV light may be visible.

1. Push the **START FAN** button on the Command Center. Check to make sure the green light on the group of UVi Status Lights mounted on the Ventilator section is on.
2. Open the UV Module Access Door.
3. Push and hold in the Door Safety Switch (Refer to Figure 6-33-1) and observe the Ventilation Fans operating. If operating, the test is complete and the Access Door can be closed. If not operating, conduct an electrical test at the connection points for voltage. If there is voltage, the Ventilation Fan is defective and must be replaced.

UV Module Ventilation Fans – Cont.

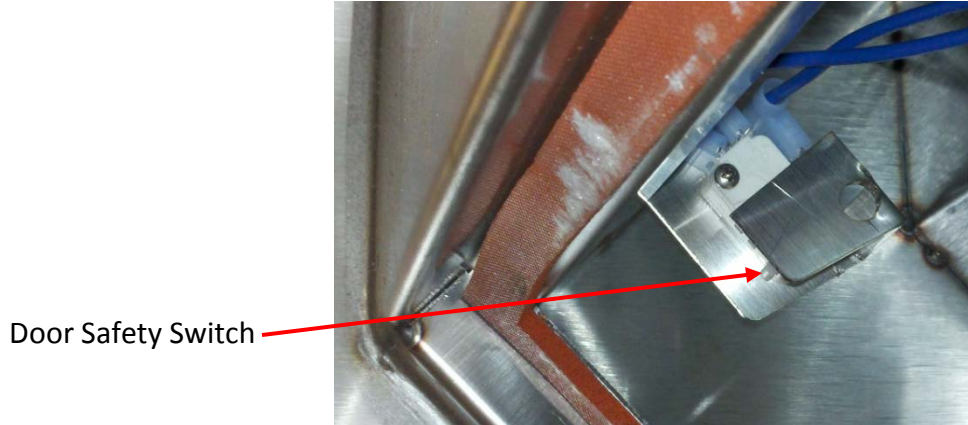

Figure 6-33-1
Door Safety SW

Instructions for Replacing UV Module Ventilation Fans

To replace UV Module Ventilation Fans carefully use the following step by step instructions.

1. Turn off all power to the Gaylord Command Center.
2. Turn off all circuits that supply power to the UV Lamps.
3. Open the UV Module Access Door.
4. Disconnect the Lamp / Ballast Connector plug (Refer to Figure 6-33-2 and 6-33-3).



Figure 6-33-2
UV Module End of Plug



Figure 6-33-3
Ventilator End of Plug

5. Remove the eight nuts that hold the Module in place.
6. Carefully slide out the UV Module and place on a work bench.
7. Next the Ballast Raceway must be removed. Using a wrench, remove the five nuts that hold the raceway to the face of the Module (Refer to Figure 6-34-1). Gently pull the Ballast Raceway off the Module as shown in Figure 6-34-2.

UV Module Ventilation Fans – Cont.

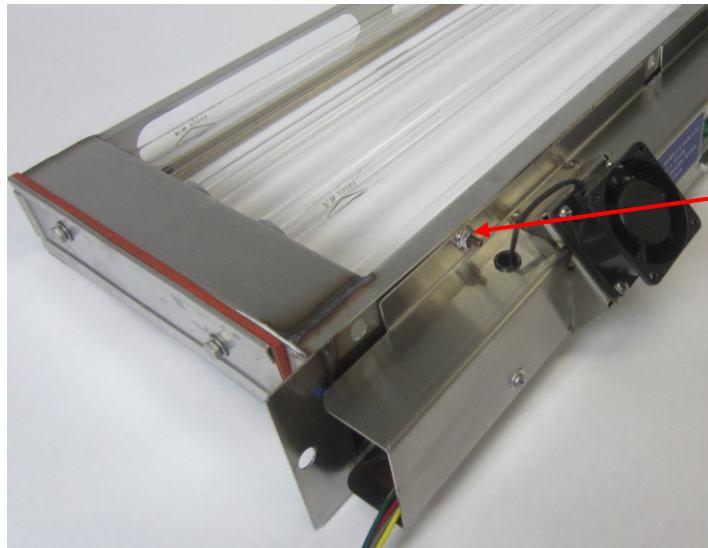

Five Nuts that Hold the Ballast Raceway to the Face of the Module

Figure 6-34-1
Removing Ballast Raceway



Figure 6-34-2
Ballast Raceway Removed from Module

8. Pull back the plastic cover, trace the two black wires from the fan back to their connection point and remove the wire nuts.
9. Sliding a small screwdriver through the front flange, remove the four fan mounting screws (Refer to Figure 6-35-1).

UV Module Ventilation Fans – Cont.

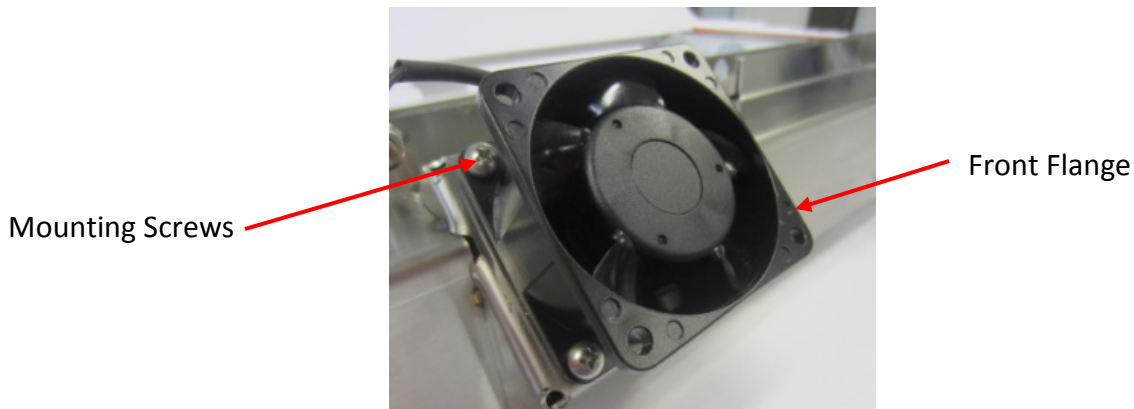

Figure 6-35-1
UV Module Ventilation Fans

10. Pull the fan from the mount along with the wires.
12. **Important Note:** When installing the new fan the label on the fan faces down on the mounting bracket as the air is pushed into the raceway. Slide the two black wires through the wire grommet.
13. Mount the new fan on the bracket with the four screws and torque to 7-9 in-lbs.
14. Reconnect the two black wires to their electrical source.
15. Slide the Ballast Raceway back into place, install the five holding nuts and torque to 7-9 in-lbs.
16. Check the UV Module Plate Gasket for cracks or deterioration (Refer to Figure 6-41-1). Replace if needed. Refer to Page 6-41 for instructions on replacing.
17. Slide the UV Module back into the Ventilator.
18. The next step is to run a test to ensure all fans are operating. Secure the Module by installing one of the holding nuts at each end.

Caution: Testing the UV Module Ventilation Fans requires the use of UV protective glasses as a small amount of UV light may be visible.
19. Reconnect the Lamp / Ballast Connector plug.
20. Turn on the power to the Command Center.
21. Turn on the circuit that supplies power to the UV Lamps.
22. Push the **START FAN** button on the Command Center.
23. Push and hold in the Door Safety Switch (Refer to Figure 6-33-1) and observe the fans operating. If operating correctly the test is complete. If the fans are not operating, troubleshoot and correct the problem and test again.
24. Once the test is complete install the remaining six nuts and torque all the holding nuts to 7-9 in-lbs.
25. **Very Important;** Carefully inspect the UV Module Access Door Gasket for cracks or deterioration (Refer to Figure 6-40-1). Replace as needed to ensure a good seal. Refer to Page 6-40 for instructions on replacing.
26. Close the UV Model Access Door.

High Temperature Shutdown Controller

Overview

A High Temperature Shutdown Controller is mounted in the Main Electrical Raceway to monitor the internal temperature of the raceway and to shut down the UV system if the temperature exceeds 118° F. (Refer to Figure 6-36-1). Temperatures above 118° may cause the components located in the Main Electrical Raceway to fail. Activation of the High Temperature Shutdown Controller will shut off the UV system, turn on the Blue “UVi System Standby” status light mounted on the Ventilator. The exhaust fan will remain on.

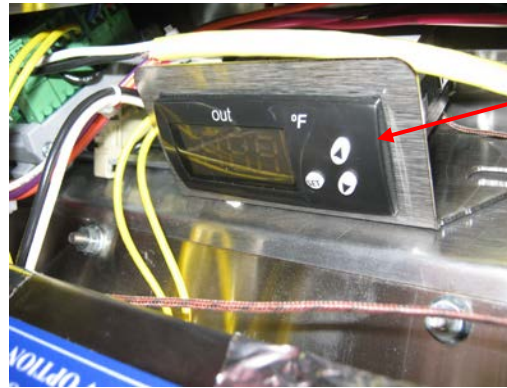

High Temperature
Shutdown Controller

Figure 6-36-1
High Temperature Shutdown Controller

Typical Activation

The High Temperature Shutdown Controller will typically activate for the following reasons:

1. The Main Electrical Raceway Ventilation Fan has failed. To replace the Ventilation Fan follow the instructions on Page 6-30.
2. The Main Electrical Raceway Ventilation Fan inlet or outlet Ventilation Snorkel is blocked by building insulation or other material (Refer to Figure 6-30-1). Corrective action: Remove any blockage from the inlet.
3. The cooking equipment under the Ventilator is in a "runaway" condition and operating too hot. Corrective action: Check with owner/equipment operator to see if cooking equipment is operating properly. If not it must be serviced.
4. Air Flow through the Ventilator is too low. Verify air volume by following the instructions beginning on Page 6-1. Correct if less than C-6-4-1 or C-6-4-2.

Important Note: The above conditions must be corrected or a UV Ballast failure will follow.

High Temperature Shutdown Controller – Cont.

Checking the High Temperature Shutdown Controller Program

The High Temperature Shutdown comes programmed from the Gaylord factory and should never need to be reprogrammed. To check the program, use the following instructions:

1. Push the **START FAN** button on the Command Center. Check to insure that the Green UVI System On status light is on.
2. Confirm controller is showing current ambient temperature (Refer to Figure 6-35-1).
3. Briefly push Set, “SP” will appear.
4. Press set a second time, then release. “118” will appear. If it does not the control is either faulty or needs to be reprogrammed. Consult a Gaylord Service Agency or call Gaylord Industries for instructions.

Safety Interlock Pressure Switch

Overview

There is a Pressure Switch mounted in the Main Electrical Raceway located above the UV Modules (Refer to Figure 6-37-1). The Pressure Switch monitors for negative pressure in the plenum of the Ventilator, created when the exhaust fan is on. If the exhaust fan should malfunction, such as slipping or broken belt, while the UV is on, the Pressure Switch will detect the reduction or absence of a negative pressure and shut down the UV System. The Pressure Switch is factory set for 0.07” static and therefore does not need adjustment.

Figure 6-37-1
Safety Interlock
Pressure Switch



UV Ventilation Control Board

Overview

The UV Ventilation Control Board (Refer to Figure 6-38-1) monitors the Safety Interlock Pressure Switch, the Extractor Inspection Doors Proximity Safety Switch and the UV Access Door Safety Switch. The UV Ventilation Control Board is located behind the removable Main Electrical Raceway Access Panels (Refer to Figure 6-38-2). When the exhaust fan is on and is operating properly, and both the Extractor Inspection and UV Access Doors are closed, the Safety Interlock Pressure Switch sends a signal to activate the Ballast Contactor allowing the UV System to operate. If the Safety Interlock Pressure Switch detects low air flow, or if an Extractor Inspection Door or UV Module Access Door is open, a signal is sent to deactivate the Ballast Contactor which turns off the UV System. The UV Ventilation Control Board has three main components, the Ballast Contactor, the Status Light Relay and the UV Monitoring Board (Refer to Figure 6-38-1).

UV Ventilation Control Board – Cont.

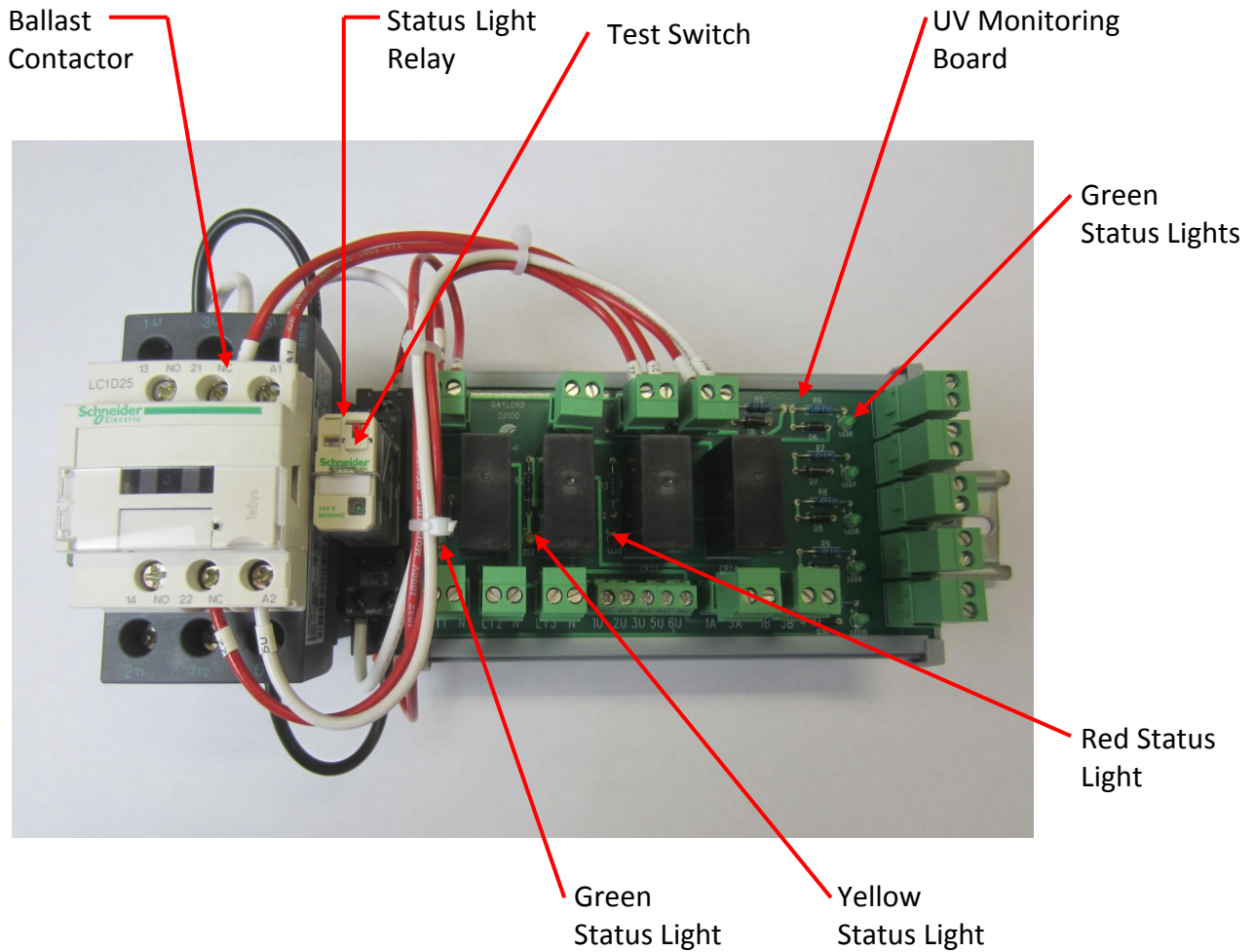

Figure 6-38-1
UV Ventilation Control Board

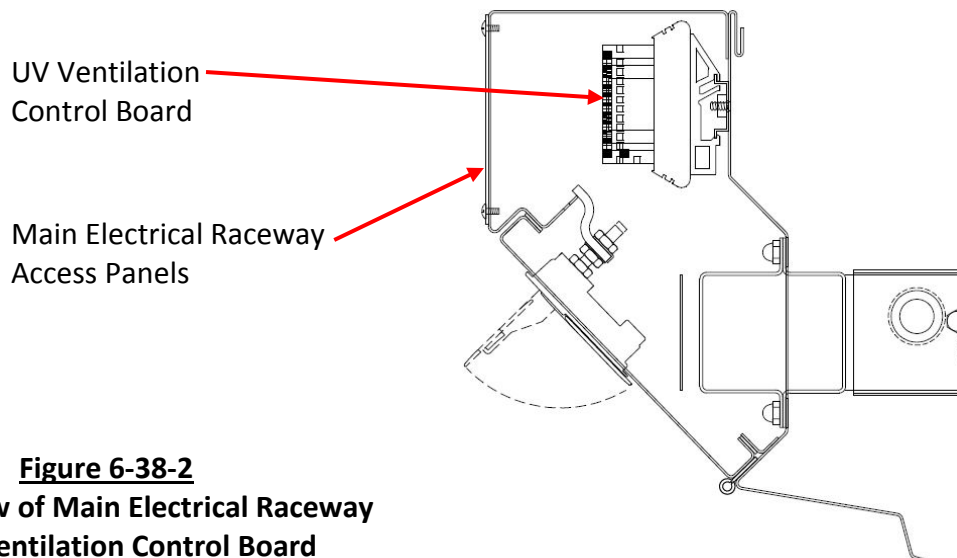

Figure 6-38-2
**Section View of Main Electrical Raceway
at UV Ventilation Control Board**

UV Ventilation Control Board – Cont.

UV Monitoring Board

The UV Monitoring Board has several Status Lights advising of proper operation or of a fault (Refer to Figure 6-38-1). The Status Lights indicate the following:

1. Green light LED1 = On whenever there is power to the Ballast Contactor.
2. Yellow light LED2 = On whenever a UV Lamp or Ballast has failed.
3. Red light LED3 = On whenever one or more lights LED1 through LED6 are off.
4. Green light LED5 = On whenever there is power to the UV Monitoring Board.
5. Green Lights LED6 through LED10 on = UV Ventilation Control Board Operating Correctly.
6. Green, Red and Yellow lights off = UV Ventilation Control Board Contactor failed, or the breaker in the building electrical panel has tripped.
7. Green light LED6 off and Red light on = Pressure switch open – low or no air flow through ventilator.
8. Green light LED7 off Red light on = First UV Module Access Door open.
9. Green light LED8 off Red light on = High Temperature Shutdown Controller shut the system down due to over 118° F. temperature in the Main Electrical Raceway.
10. Green light LED9 off Red light on = Extractor Inspection Door open.
11. Green light LED10 Red light on = Second UV Module Access Door open (if there is a second door).
12. Yellow light on = UV Lamp or Ballast failure.

Status Light Relay

The relay troubleshoots the Ballast Contactor. If LED1 is off there is no power to the contactor. If there is no power to the Ballast Contactor you can simulate power to the Ballast by flipping the Test Switch on top of the relay (Refer to Figure 6-38-1).

Ballast Contactor

The Ballast Contactor moves to the closed position sending power to the UV Modules whenever the Exhaust Fan is started and the Pressure Switch is closed (Airflow through the Ventilator), the UV Module Access Doors are closed, the Extractor Inspection Doors are closed and the High Temperature Shutdown Controller sensor has is below 118° F. If LED5, through LED10 are on and the Contactor will not engage it indicates that the Ballast Contactor has failed.

If it is determined that any of these three components are defective they must be replaced.

Caution: Turn off all power to the Command Center and to the UV Ballast Box. There is a risk of shock, injury, and /or death from live electrical components.

Replacing UV Module Access Door Gasket

Overview

A deteriorating Access Door Gasket will allow grease to migrate into the UV Module and Main Electrical Raceways and cause the UV Module and other electrical components to fail. Carefully inspect the UV Module Access Door Gasket for cracks or deterioration (Refer to Figure 6-40-1).. Replace as needed to ensure a good seal.

Figure 6-40-1
UV Module Access Door

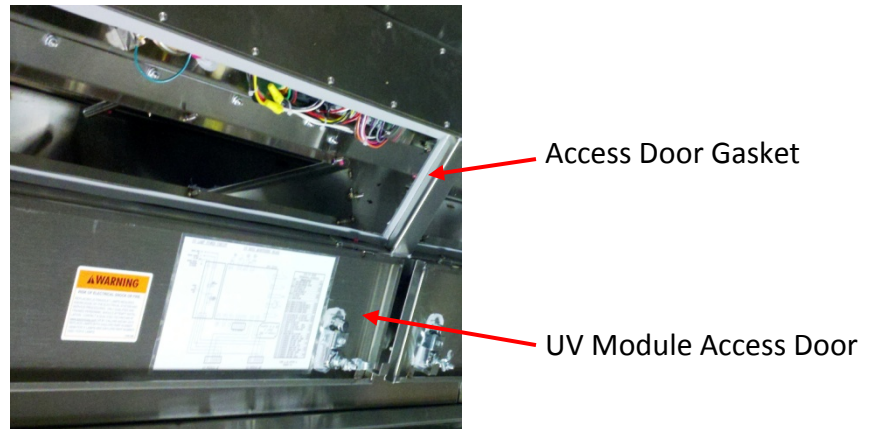

Instructions for Replacing UV Module Access Door Gaskets

1. Remove the old Door Gaskets and scrap the residual gasket material and adhesive from the stainless receiver.
2. Clean the receiving area thoroughly with alcohol.

Explanatory Note: The replacement gasket material comes in a roll and has a peel off sticky back.

3. Cut the two long horizontal gaskets to length.
4. At one end of the gasket peel back 3" or 4" of the protective backing. Beginning at one end, apply the gasket to the stainless and then continue removing the backing and applying the gasket at the same time until installed.
5. Run your finger or a smooth dull object along the gasket, pushing to insure a good bond.
6. Once the horizontal gaskets are in place, measure and cut the two vertical gaskets.
7. Install the vertical gaskets in the same manner.
8. Apply a bead of silicone to the four joint intersections of the gaskets (Refer to Figure 6-40-2).

Important Note: Do not close the Access Door until the silicone has dried.

Figure 6-40-2
UV Module Access
Door Gasket

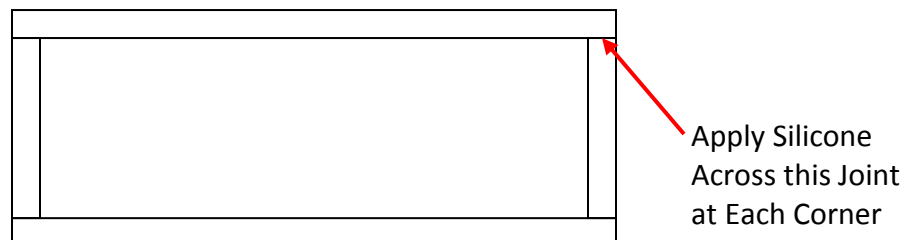

Replacing UV Module Plate Gasket

Overview

A deteriorating UV Module Plate Gasket will allow water to leak into the UV Module Electrical Raceway and cause the UV Module and other electrical components to fail. Carefully inspect the UV Module Plate Gasket for cracks or deterioration (Refer to Figure 6-41-1). Replace as needed to ensure a good seal.

Instructions for Replacing UV Module Plate Gasket

1. Turn off all power to the Gaylord Command Center.
2. Turn off all circuits that supply power to the UV Lamps.
3. Open the UV Module Access Door.
4. Disconnect the Lamp / Ballast Connector plug (Refer to Figure 6-9-1 and 6-9-2).
5. Remove the eight nuts that hold the Module in place.
6. Carefully slide out the UV Module and place on a work bench.
7. Remove the old UV Module Plate Gasket and scrap the residual gasket material and adhesive from the stainless steel.
8. Clean the receiving area thoroughly with alcohol.

Explanatory Note: The replacement gasket comes as one piece with punched holes for going over the threaded weld studs. The gasket has a peel off sticky back.

9. Starting at one end peel back about 4" of the Mylar protective cover, to expose the sticky surface, and place the gasket over the first threaded studs and apply to the stainless surface.
10. Continue peeling off the back and apply the gasket as you continue. As you apply be sure to keep the gasket straight.
11. Once the entire gasket is in place, run your finger or a smooth dull object along the gasket, pushing to insure a good bond.
12. Slide in the UV Module, install the eight nuts that hold the UV Module in place and torque to 7-9 inch - lbs.
13. Reconnect the Lamp / Ballast Connector plug.
14. Check the UV Module Access Door Gasket for cracks and deterioration and replace if needed. Refer to Page 6-40 for instructions on replacing.
15. Close the UV Module Access Doors.
16. Turn on all circuits that supply power to the UV Lamps.
17. Turn on power to the Gaylord Command Center.

Holes for
Threaded Studs

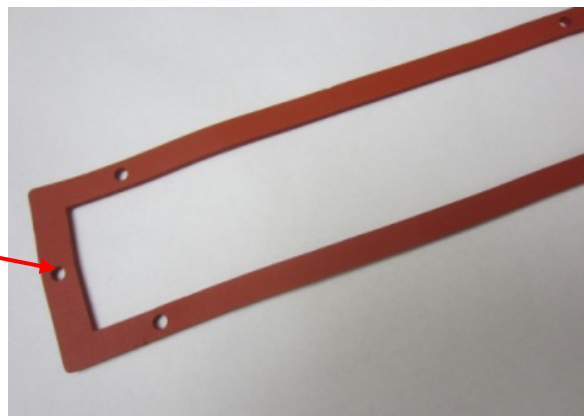

Figure 6-41
Partial View of UV
Module Plate
Gasket

Damper Motor

Overview

Model CG3-UVi Ventilators include a three position damper referred to as Baffle #1 in the Principle of Operation section of this manual (Refer to Figure 2-3-1, 2-6-1 and 2-8-1). The damper is driven by an 24 volt AC/DC Electric Damper Motor located behind an access panel at one end of the Ventilator (Refer to Figure 6-42-1 and 6-42-2). The damper motor is called a “motor drive, spring return” type motor and the mode of operation of the motor to the damper positions is as follows:

Damper Position #2 – The Damper is in the Wash Cycle or Exhaust Fan Off mode (Refer to Figure 2-6-1). The Damper is electrically driven to this position from any other position, position #1 or #3.

Damper Position #1 – The Damper is in the Exhaust Mode (Refer to Figure 2-3-1). The damper is electrically driven to this position.

Damper Position #3 – The Damper is in the Fire Mode (Refer to Figure 2-8-1). The damper is driven to this position via and internal spring in the motor no electricity required.

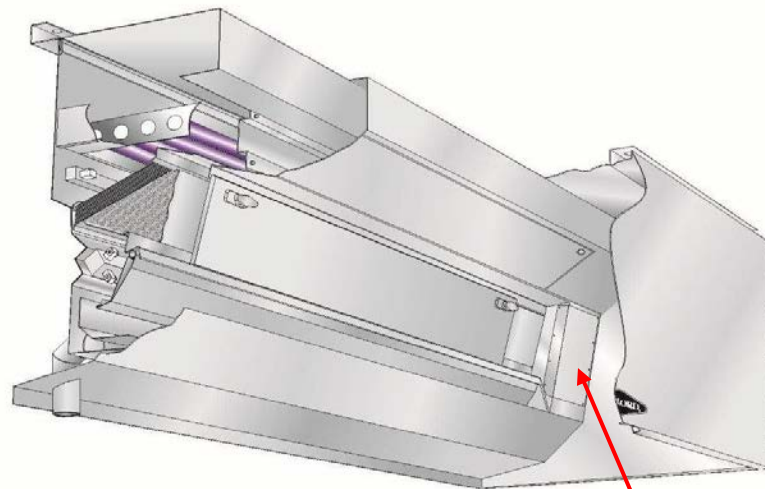

Figure 6-42-1
CG3-UV Ventilator Cut

Access Panel to
Damper Motor

Figure 6-42-2
Damper Motor



Damper Motor – Cont.

Replacing a Damper Motor

If it is determined that the Damper Motor has failed remove the old motor and install a new one as follows.

Removal

1. Turn off the electrical power to the Command Center.
2. Remove the Damper Motor Access Panel (Refer to Figure 6-42-1).
3. Loosen the two nuts on the Shaft Clamp (Refer to Figure 6-44-1).
4. Remove the holding nut at the top of the motor.
5. Slide the motor off the Damper Shaft and out of the Ventilator.
6. Remove the cove from the j-box located behind the motor and disconnect the 3 wires from the terminal strip.

Replacing

1. Next it is necessary to “set up” the motor prior to installing. Remove the “C” clip that holds the Shaft Clamp and remove the Shaft Clamp (Refer to Figure 6-44-1).

Explanatory Note: In examining the motor, note that it is two sided, with the plastic switches and markings on one side being a mirror image of the other side. The motor is always mounted vertical with the electrical cord closest to the access panel (Refer to Figure 6-44-1). Depending upon the type of cooking equipment under the Ventilator and the number of Ventilator sections in a continuous line determines which end of the Ventilator the Damper Motor is located. The location determines which side of the Motor the Shaft Clamp is mounted on.

2. With the Motor Crank provided, place the crank in the Crank Receiver (it does not matter which side of the motor) turn the crank two full turns, and while holding the crank push the Spring Drive Lock to the lock position then release the crank and then the lock (Refer to Figure 6-44-1).
3. Looking at the end of the Motor with the electrical cord closest to you, place the Shaft Clamp on the Shaft Receiver on the appropriate side, left side if the Motor is on the left end of the Ventilator and right side if mounted on the right end, with the Shaft Clamp nuts facing you. In Figure 6-44-1 the Motor is set up for mounting at the left end. As a double check of facing the Motor in the correct position, the arrow on the Crank Receiver should always be pointing towards the back of the Ventilator (Refer to Figure 6-45-1).
4. Slide in the “C” ring to lock the Shaft Clamp into position.
5. Check to see that the End Switch Positioner Switch (not used for Gaylord application) is set to the arrow that is in the same direction as the spring drive direction (Refer to Figure 6-45-2).
6. Remove and throw away the Stop Screw located next to the Shaft Clamp (Refer to Figure 6-45-1). This is not used on Gaylord applications.
7. Of the 5 wires coming out the cord, only the Red, White and Black wires are used. Tape the Pink and Orange wires back alongside the black cord. Connect the Red, White and Black wires to the terminal strip. **Note:** All wires match color for color except the white wire from the Motor connects to a light gray wire on the terminal strip. Replace the j-box cover.
8. Slide the Motor over the Damper shaft and upper mounting stud, install the nut on the upper mounting stud and torque to 7-9 in-lbs.

Damper Motor – Cont.



Stop Screw Must Be Removed

Figure 6-45-1
Stop Screw

End Switch Positioner Switch. Set So It Is Facing The Arrow that Matches the Arrow Of The Crank Receiver Arrow.



Crank Receiver

Crank Receiver Arrow

Figure 6-45-2
End Switch Positioner Switch





This Page Intentionally Left Blank

Parts

Overview

The parts shown on the following pages are available from a Gaylord Certified Service Agency (CSA). For the location of your nearest CSA please go to www.galordventilation.com and click on Service Agency Locator.

Table T-7-1-1





Parts - Ventilator			
Pc. No.	Description	Gaylord Part No.	Illustration
1	Wash Spray Nozzles Single Head Double Head High Volume (Single Head)	10303 10304 10305	
2	Cold Water Mist Nozzles	15330	
3	Extraction Chamber Inspection Door Handles Handle Complete Tongue Only	18242 18243	
4	Lift and Turn Latch for UV Module Access Door	19351	
5	100 Watt Surface Mounted Light Housing Globe	10120 10119	

Parts Cont.

Table T-7-2-1

Parts - Ventilator			
Pc. No.	Description	Gaylord Part No.	Illustration
	12 x 12 Recessed Incandescent Light with Lens (Complete light)	19623	
2	48" Long Recessed Fluorescent Light with Lens (Complete Light)	19651	
3	36" Long Recessed Fluorescent Light with Lens (Complete Light)	19681	
4	LED Lamp for Recessed Fluorescent Lights For 36" Fluorescent Lights For 48" Fluorescent Lights	20613 20614	
5	Exhaust Duct Thermostats 12" Length 250°F 15" Length 250°F	18781 18782	
6	Exhaust Duct Fire Damper Fuse Link 280°F. (For CG3-UVi-FDD and CG3-UVi-FDT Series)	10323	
7	Supply Duct Collar Fire Damper Fuse Link 165°F.	10321	

Parts – Cont.Table T-7-3-1

Parts – Ventilator – Cont.			
Pc. No.	Description	Gaylord Part No.	Illustration
1	UV Status Lamp – Green	19725	
2	UV Status Lamp – Yellow	19724	
3	UV Status Lamp – Blue	19723	
4	Autostart Sensor (Does not include mounting plate shown in photo)	20319	
5	Autostart Controller complete with box	20510	
6	Damper Control Motor	18979	

Parts Cont.**Table T-7-4-1**

Parts - UV Lamp Module				
Pc. No.	Description	Qty. per Module	Gaylord Part No.	Illustration
1	UV Module – 3'-0", with 6 lamps		75876	
2	UV Module – 5'-0", with 6 lamps		75877	
	Lamp Module End Cap Bolts, Washers & Nuts			Not Illustrated
3	1/4-20 x 3.25 Inch Hex Head Bolt	4	20284	
4	1/4 Bonded SS Sealing Washer	8	20140	
5	1/4 inch SS Hex Nut	4	20290	
6	Gasket for Lamp Module End Cap	2	20299	
7	UV Lamp Grommet	12	19312	
8	Heraeus UV Lamp 3'-0" Lamp (single lamp each) 5'-0" Lamp (single lamp each)	* *	20269 20270	
9	UV Module Ventilation Fan		20016	
10	UV Module Access Door Gasket – Peel off sticky back roll. Two rolls required for 3'-0" Module and three rolls required for 5'-0" Module.		19794	Not Illustrated

Parts – Cont.**Table T-7-5-1**







Parts - UV Lamp Module – Cont.				
Pc. No.	Description	Qty. per Module	Gaylord Part No.	Illustration
1	UV Module Plate Gasket – Peel off sticky back. For 3'-0" Module Door For 5'-0" Module Door		75878 75879	
2	UV Lamp Socket with wire – xx" long		19799	
3	UVi Ballast – 120 volt (Includes clear plastic protective cover, does not include the stainless steel raceway).		20305	

Table T-7-5-2

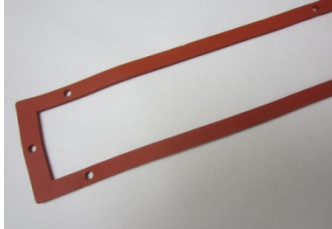

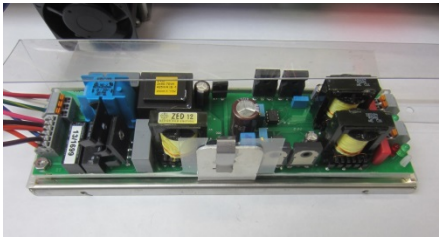
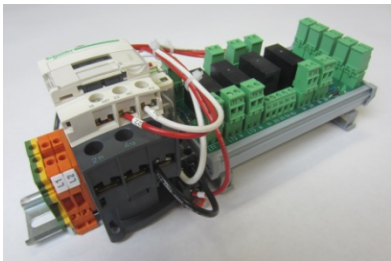
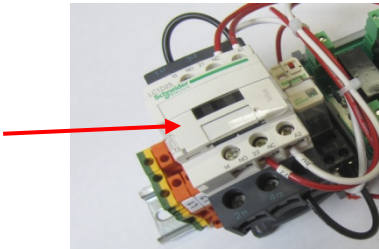
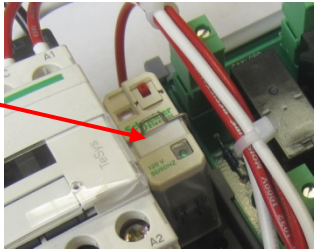
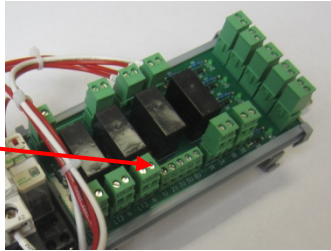
Parts – Main Electrical Raceway			
Pc. No.	Description	Gaylord Part No.	Illustration
1	UV Ventilation Control Board – Complete Mounted on Din Rail	76028	
2	Ballast Contactor	30529	

Parts – Cont.

Table T-7-6-1

Parts – Main Electrical Raceway – Cont.			
Pc. No.	Description	Gaylord Part No.	Illustration
1	Status Light Relay Relay Base	11399 11413	
2	UV Monitoring Board	20100	
3	Temperature Shutdown Controller	20421	
4	Pressure Switch	19365	
5	Main Electrical Raceway Ventilation Fan	19430	

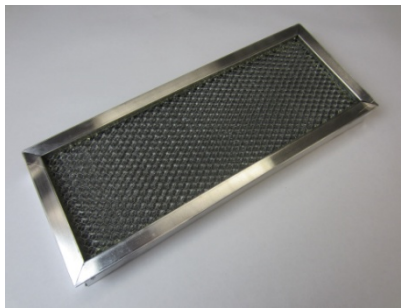
Parts – Cont.**Table T-7-7-1**

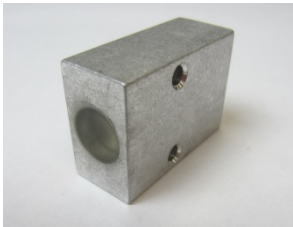
Parts – Miscellaneous			
Pc. No.	Description	Gaylord Part No.	Illustration
1	Particulate Separator 16" long, standard extractor – (UV-16)	19353	
2	Particulate Separator 20" long, standard extractor – (UV-20)	19354	
3	Particulate Separator 16" long enlarged extractor – (UV-EN-16)	19380	
4	Particulate Separator 20" long standard extractor – (UV-EN-20)	19381	
5	UV Module Access Door Safety Switch	19355	
6	Extraction Chamber Proximity Safety Switch with Wire	19416	
7	Extraction Chamber Proximity Safety Switch Magnet	19417	

This Page Intentionally Left Blank

The Wiring Diagrams on the following pages are typical for typical CG3-UVi Series Ventilators using a Model C-6000-D Command Center but may not represent your installation. Always refer to the Gaylord submittal drawings for the actual Wiring Diagrams for your installation.

Wiring Diagram – UV Ventilation Control Board

UVi LAMP POWER CIRCUIT

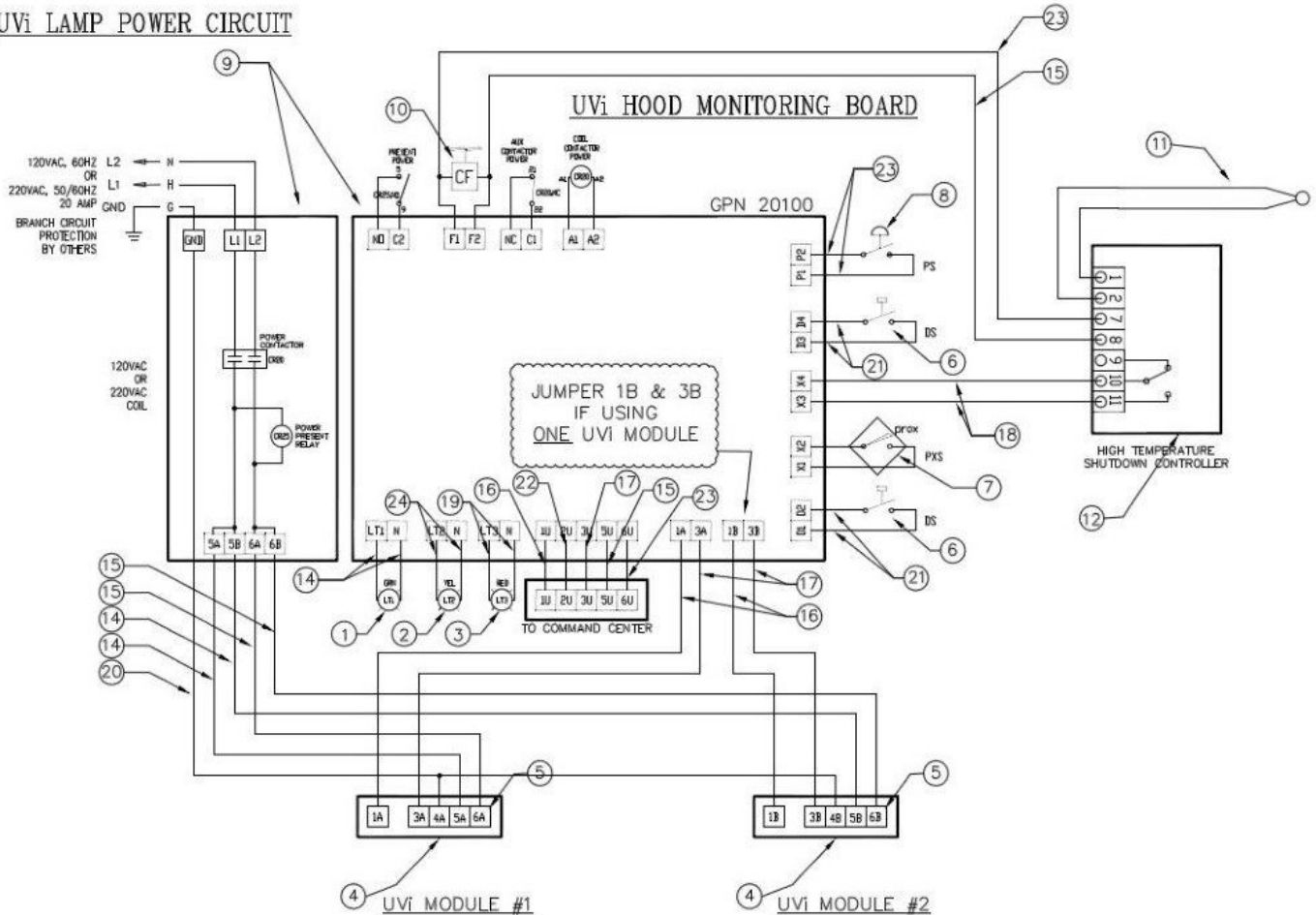

CG3-UVi HOOD TERMINAL SCHEDULE		
TRM	TERMINATION SCHEDULE	TYPE
L1	MAIN POWER CONNECTION : HOT	120VAC
L2	MAIN POWER CONNECTION : NEUTRAL	0 V
NO,C2	N.O. CONTACTS OF CR25	120VAC
F1	HOT FOR COOLING FAN	120VAC
F2	NEUTRAL FOR COOLING FAN	0 V
NC,C1	N.C. CONTACTS OF CR20	120VAC
A1	HOT FOR CR20	120VAC
A2	NEUTRAL FOR CR20	0 V
P1,P2	TERMINALS FOR PRESSURE SWITCH	120VAC
D1,D2	TERMINALS FOR UV ACCESS DOOR SWITCH #1	120VAC
D3,D4	TERMINALS FOR UV ACCESS DOOR SWITCH #2	120VAC
X1,X2	TERMINALS FOR UV PROXIMITY SWITCHES	120VAC
X3,X4	TERMINALS FOR HIGH TEMP SHUTDOWN (N.O.)	120VAC
L71	HOT FOR GREEN LIGHT - "UV SYSTEM ON"	120VAC
L72	HOT FOR YELLOW LIGHT - "UV LAMP FAILURE"	120VAC
L73	HOT FOR RED LIGHT - "UV SAFETY INTERLOCK"	120VAC
N	NEUTRAL FOR STATUS LIGHTS	0 V
1U	OUTPUT - "UV SYSTEM ON" (GREEN)	120VAC
2U	OUTPUT - "UV LAMP FAILURE" (YELLOW)	120VAC
3U	OUTPUT - "UV SAFETY INTERLOCK" (RED)	120VAC
5U	120VAC NEUTRAL LEG	0 V
6U	SWITCHED POWER FOR UV LAMP CIRCUIT	120VAC
1A	UV CONTROLLER - SUMMARY ALARM - N/C	120VAC
3A	UV CONTROLLER - SUMMARY ALARM - COMMON	120VAC
4A	UV CONTROLLER - INPUT POWER - GROUND	0 V
5A	UV CONTROLLER - INPUT POWER - HOT	120VAC
6A	UV CONTROLLER - INPUT POWER - NEUTRAL	0 V
1B	UV CONTROLLER - SUMMARY ALARM - N/C	120VAC
3B	UV CONTROLLER - SUMMARY ALARM - COMMON	120VAC
4B	UV CONTROLLER - INPUT POWER - GROUND	0 V
5B	UV CONTROLLER - INPUT POWER - HOT	120VAC
6B	UV CONTROLLER - INPUT POWER - NEUTRAL	0 V

ITEM NO.	DWG. NUMBER	DESCRIPTION	QTY.	REV
24	GPN 15245	18 AWG CONTROL WIRE (YELLOW)	VARIES	BO
23	GPN 13160	18 AWG CONTROL WIRE (PINK)	VARIES	BO
22	GPN 19384	18 AWG CONTROL WIRE (BROWN)	VARIES	BO
21	GPN 19383	18 AWG CONTROL WIRE (BLUE)	VARIES	BO
20	GPN 19389	18 AWG CONTROL WIRE (GREEN)	VARIES	BO
19	GPN 19385	18 AWG CONTROL WIRE (RED)	VARIES	BO
18	GPN 19387	18 AWG CONTROL WIRE (GRAY)	VARIES	BO
17	GPN 19388	18 AWG CONTROL WIRE (PURPLE)	VARIES	BO
16	GPN 19429	18 AWG CONTROL WIRE (ORANGE)	VARIES	BO
15	GPN 19386	18 AWG CONTROL WIRE (WHITE)	VARIES	BO
14	GPN 19382	18 AWG CONTROL WIRE (BLACK)	VARIES	BO
13	GPN 20392	LOVE / TCS TEMP CONTROLLER MOUNT (NOT SHOWN)	1	00
12	GPN 20421	LOVE / TCS SERIES TEMPERATURE CONTROLLER	1	BO
11	GPN 20394	TEMP CONTROL THERMOCOUPLE	1	00
10	GPN 19430	124 CFM OPEN AXIAL FAN	1	BO
9	GPN 76028	UVI HOOD MONITOR-02-USA-120V	1	BO
8	GPN 19365	UV-P/S 1910-00 PRESET 0.07"MG	1	BO
7	GPN 19416	PROXIMITY SWITCH - 16" CORD	1	BO
6	GPN 19355	UV ACCESS DOOR SWITCH 3AMP/250VAC/D	1-2	BO
5	GPN 11033	20-14 AWG PIN CONTACT	5 / 10	BO
4	GPN 16903	6 CIRCUIT CAP HOUSING	1	BO
3	GPN 19723	RED 130V LED 16MM IP LAMP	1	BO
2	GPN 19724	FLT YELLOW LED CHROME IND LAMP	1	BO
1	GPN 19725	GREEN 130V LED 16MM IP LAMP	1	BO

Wiring Diagram – Typical of Two Ventilator Sections – Continued on next Page

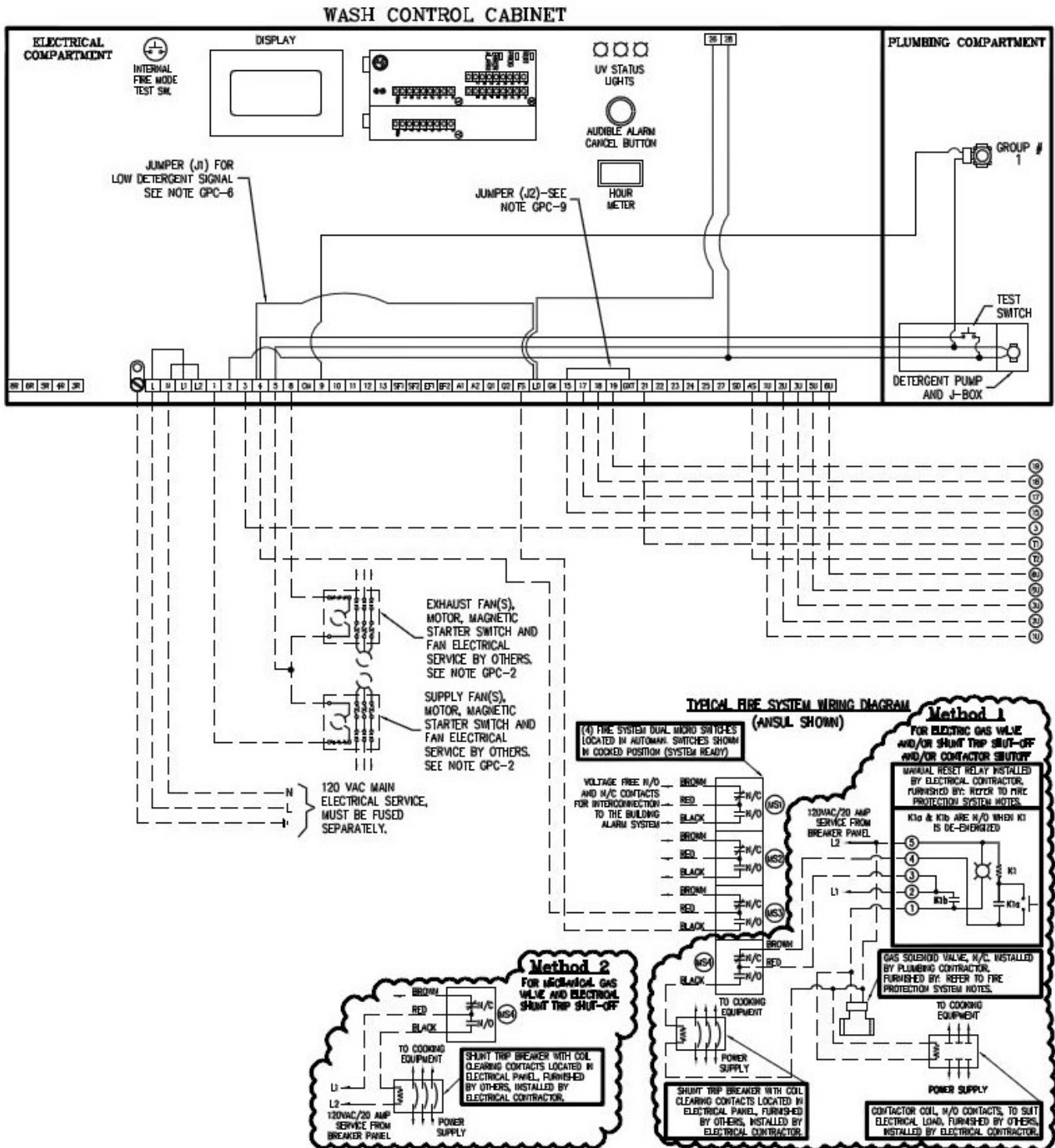

Wiring Diagram – Typical of Two Ventilator Sections

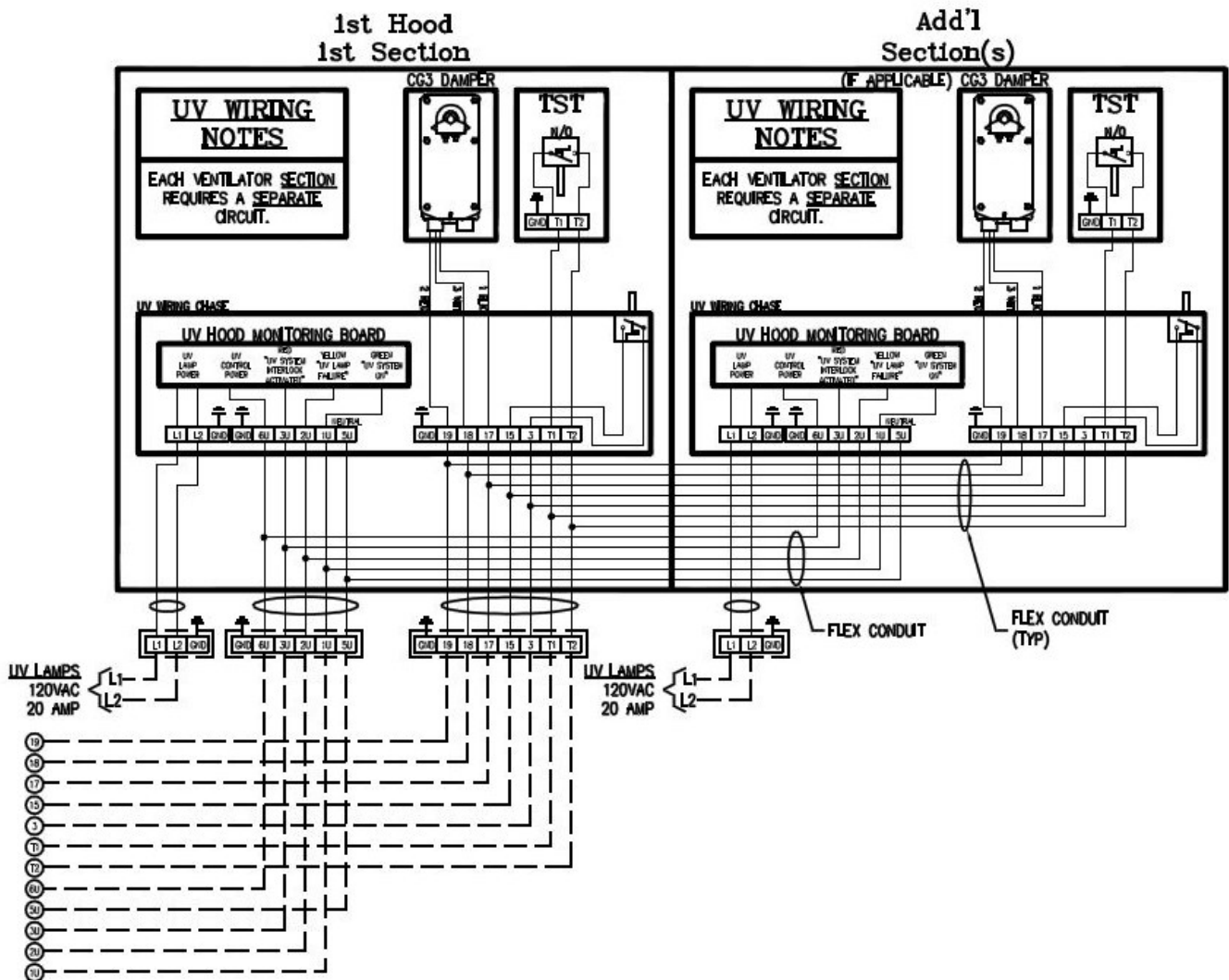

NOTE: Refer to Table T-8-4-1 on Page 8-4 for Terminal Connection Explanations

Wiring Diagram – Typical of Two Ventilator Sections

--- FIELD WIRING BY OTHERS
 — WIRING BY GAYLORD

**GAYLORD AUTOSTART
 THERMOSTAT
 "TST" NOTES**

A) INSTALLED IN HOOD
 B) PRESET TO 90F AT FACTORY
 C) IN SOME CLIMATES AND/OR CONDITIONS,
 IT MAY BE NECESSARY TO ADJUST THE
 "TST" TEMPERATURE SETTING IN THE
 FIELD BY OTHERS

**Table T-8-4-1
 Terminal Connections Points**

--- SUPPLY VOLTAGE --- 120 VAC, 60Hz 15 AMPS MAXIMUM - CONNECTED LOAD		
TRM	TERMINATION SCHEDULE	TYPE
L	MAIN POWER CONNECTION : HOT	120VAC
N	MAIN POWER CONNECTION : NEUTRAL	0 V
L1	MAIN POWER CONNECTION : HOT DO NOT CONNECT INCOMING POWER	120VAC
L2	MAIN POWER CONNECTION : NEUTRAL DO NOT CONNECT INCOMING POWER	0 V
1	OUTPUT-SUP. FAN STARTER (1 AMP MAX.)	120VAC
2	OUTPUT TO DETERGENT PUMP - HOOD(S)	120VAC
3	THERMOSTAT RETURN - HOOD(S)	24VAC
4	FUSED SUPPLY TO PLC OUTPUTS & ETC	120VAC
5	120VAC NEUTRAL LEG	0 V
8	OUTPUT-EXH. FAN STARTER (1 AMP MAX.)	120VAC
CM	OUTPUT TO COLD WATER MIST SOLENOID	120VAC
9	OUTPUT TO WASH SOLENOID VALVE #1	120VAC
10	OUTPUT TO WASH SOLENOID VALVE #2	120VAC
11	OUTPUT TO WASH SOLENOID VALVE #3	120VAC
12	OUTPUT TO WASH SOLENOID VALVE #4	120VAC
13	OUTPUT TO WASH SOLENOID VALVE #5	120VAC
SF1	N.O. DRY CONTACTS FOR SUPPLY FAN	N/A
SF2	REMOTE CONTROL CENTER	N/A
EF1	N.O. DRY CONTACTS FOR EXHAUST FAN	N/A
EF2	REMOTE CONTROL CENTER	N/A
A1	N.O. DRY CONTACTS FOR INTERFACE TO	N/A
A2	BUILDING FIRE ALARM / MONITOR SYSTEM	N/A
Q1	N.C. DRY CONTACTS FOR INTERFACE TO	N/A
Q2	BUILDING FIRE ALARM / MONITOR SYSTEM	N/A
FS	INPUT FROM REMOTE FIRE SWITCH	120VAC
LD	INPUT FROM DETERGENT FLOW SWITCH	120VAC
QK	POWER FOR QK2 DAMPER ACTUATORS	24VAC
15	OUTPUT TO THERMOSTAT(S)	24VAC
17	24VAC COMMON	0 V
18	QK3 DAMPER DRIVE SIGNAL	0-24VAC
19	POWER FOR QK3 DAMPER ACTUATORS	24VAC
GXT	THERMOSTAT RETURN FOR QK2 HOODS	24VAC
21	SUPPLY TO OUTPUTS	24VDC
22	DISABLE WASH SOLENOIDS DURING AN INT. OR EXT. FIRE MODE JUMPER	24VDC INPUT
23	INPUT - WASH START PERMISSION FROM A REMOTE LOCATION	24VDC INPUT
24	INPUT - START FAN SIGNAL FROM A REMOTE LOCATION	24VDC INPUT
25	INPUT - START WASH SIGNAL FROM A REMOTE LOCATION	24VDC INPUT
26	INPUT - LOW DETERGENT SIGNAL (SUB PANEL / ESP WASHES)	120VAC INPUT
27	INPUT - START FAN/START WASH SIGNAL FROM A REMOTE LOCATION	24VDC INPUT
28	OUTPUT - DETERGENT PUMP # 2 (SUB PANEL / RSPC-ESP)	120VAC
SD	OUTPUT - SOLENOID DRAIN	120VAC
AS	INPUT - "TST" TEMPERATURE SENSING THERMOSTAT	24VDC INPUT

TRM	TERMINATION SCHEDULE	TYPE
3R	THERMOSTAT RETURN - PCU	120VAC
4R	FUSED SUPPLY - PCU	120VAC
5R	120VAC NEUTRAL LEG - PCU	0VAC
6R	(SWITCHED) POWER FOR PCU POWER PACKS	120VAC
8R	CONTROL VOLTAGE TO MAG STARTER	120VAC

TRM	TERMINATION SCHEDULE	TYPE
1U	INPUT FROM "UV SYSTEM ON" (GREEN)	120VAC
2U	INPUT FROM "UV LAMP FAILURE" (AMBER)	120VAC
3U	INPUT FROM "UV SAFETY INTERLOCK" (RED)	120VAC
5U	NEUTRAL LEG	0V
6U	OUTPUT TO UV LAMPS CONTACTOR	120VAC

Sample Ventilator Nameplate



EXHAUST HOOD WITH EXHAUST DAMPER

ALSO LISTED AS AN EXHAUST HOOD WITHOUT EXHAUST DAMPER WHEN EQUIPPED WITH FIRE DAMPER LOCK-OUT PART NUMBER FDL.

FOR USE ONLY WITH GAYLORD INDUSTRIES LISTED SUB-ASSEMBLY CONTROL CABINET MODEL NUMBER GPC-6000-UV-SPC OR GPC-6000-ESP SERIES.

THIS EXHAUST HOOD HAS BEEN TESTED TO STANDARD UL 710 "EXHAUST HOODS FOR COMMERCIAL COOKING EQUIPMENT, UL 867 "ELECTROSTATIC AIR CLEANERS", AND WHERE APPLICABLE TO UL 710 C "ULTRAVIOLET LAMPS USED FOR REDUCTION OF GREASE LADEN VAPOR FROM COOKING EQUIPMENT".

THIS EXHAUST HOOD IS LISTED UNDER INTERTEK ETL SEMKO REPORT NUMBER 3120925CRT-001. FOR ADDITIONAL INFORMATION GO TO WWW.INTERTEK-ETLSEMKO.COM.

THIS EXHAUST HOOD MEETS ALL REQUIREMENTS OF THE LATEST EDITION OF NFPA-96 AND THE IMC (INTERNATIONAL MECHANICAL CODE)



COA #5519

WORLD HEADQUARTERS
GAYLORD INDUSTRIES
10900 S.W. AVERY STREET
TUALATIN, OR 97062 USA

PHONE: 503-691-2010
FAX: 503-692-6048
EMAIL: info@gaylordusa.com
www.gaylordusa.com

Form No. CG3-UV-SPC 0310 / 19810

ENGINEERING DATA

1. MINIMUM TOTAL EXHAUST VOLUME FOR THIS HOOD SECTION	C.F.M.
2. MAXIMUM TOTAL SUPPLY VOLUME FOR THIS HOOD SECTION	C.F.M.
3. EXHAUST STATIC PRESSURE AT DUCT COLLAR	W.G.
4. SUPPLY STATIC PRESSURE AT DUCT COLLAR	W.G.

5. THIS HOOD SECTION SUITABLE FOR APPLIANCES WITH MAXIMUM COOKING SURFACE TEMPERATURE OF:

	FOR		LINEAL FT. OF HOOD
	FOR		LINEAL FT. OF HOOD

6. REFER TO GAYLORD VENTILATOR TECHNICAL MANUAL FOR INLET SLOT VELOCITY REQUIREMENTS AND METHOD OF CHECKING VELOCITY

7. ELECTRICAL RATING OF LIGHT FIXTURES: 120 VOLT, 60 HZ. OR 220 VOLT, 50 HZ. OVERALL RATING - 12 AMPS OR LESS

8. VENTILATOR ELECTRICAL CONTROL CIRCUIT MUST BE FUSED SEPARATELY

9. CG3-FDD SERIES VENTILATORS ARE EQUIPPED WITH A FUSE LINK OPERATED EXHAUST FIRE DAMPER. USE ONLY 280° F, RATED 30 LBS. MIN. UL LISTED FUSIBLE LINK FOR REPLACEMENT.

HOOD MOUNTING REQUIREMENTS

MINIMUM DISTANCE FROM COOKING SURFACE TO FRONT LOWER EDGE OF HOOD	36"
MAXIMUM DISTANCE FROM COOKING SURFACE TO FRONT LOWER EDGE OF HOOD	48"
MINIMUM OVERHANG FROM FRONT OF HOOD CAVITY TO FRONT OF COOKING SURFACE	
MINIMUM OVERHANG FROM SIDE OF HOOD TO EDGE OF COOKING SURFACE	

SERIAL NO:

MODEL NO:

OPERATION AND MAINTENANCE INSTRUCTIONS

IF THE VENTILATOR(S) HAS A FUSE LINK OPERATED EXHAUST OR SUPPLY DUCT FIRE DAMPER THE NATIONAL FIRE PROTECTION ASSOCIATION'S PAMPHLET NFPA-96 REQUIRES INSPECTION OF THE FUSE LINK EVERY 6 MONTHS AND REPLACED ANNUALLY. REFER TO THE GAYLORD VENTILATOR TECHNICAL MANUAL FOR DETAILS REGARDING SYSTEM OPERATION, MAINTENANCE, AND SAFETY CONCERNS.

CAUTION: ALWAYS START THE VENTILATOR EXHAUST FAN BEFORE TURNING ON COOKING EQUIPMENT. ELECTROSTATIC CELLS SHOULD BE INSPECTED FREQUENTLY TO ENSURE COLLECTED GREASE IS BEING REMOVED BY THE WASH SYSTEM. CELLS WEIGH MORE THAN 45 LBS. HANDLE WITH CARE WHEN REMOVING. DO NOT DEFEAT ANY INTERLOCK - DOING SO CAN EXPOSE THE USER TO ULTRAVIOLET RADIATION AND / OR HIGH VOLTAGE SHOCK.

Exhaust CFM Here

Serial # Here

Model # Here

Figure A-1-1
Sample Ventilator Nameplate
One Mounted on Each Ventilator Section

This Page Intentionally Left Blank

Installation Requirements

Code Compliance

Ventilators must be installed to comply with all applicable codes.

1. Ventilator to be installed in accordance with NFPA-96, Standard for Ventilation Control and Fire Protection of Commercial Cooking Operations, the IMC, International Mechanical Code, and all other local applicable codes.
2. All plumbing and electrical must comply with the applicable codes.
3. Contractors must review applicable codes with code authorities before approving drawings for fabrication.
4. Special attention must be given to code regulations relative to clearances from surrounding combustible constructions (walls, ceilings, etc.).

Permits

IMPORTANT NOTE: Most building departments require the Ventilator (hood) permit separate from any other general building permit. In addition if a Fire Extinguishing System is involved a separate permit from the Ventilator permit is typically required. The Ventilator permit is typically obtained through the plan review department and the Fire Extinguishing System permit through the fire prevention bureau. The installing contractor must check with local building departments for their requirements, and to obtain necessary permits.

Ventilator Listing

The Gaylord Model CG3-UVi Series Ventilators are listed to UL 710 and Recognized by ETL. Any modification made to the Ventilator at the jobsite will void the listing.

Hanging the Ventilator

Use the following guidelines for hanging the Gaylord Ventilator:

1. The maximum section length of a Gaylord Ventilator is 16'-0". Ventilators longer than 16'-0" are made up of multiple sections.
2. The weight of the Ventilator is shown on the Gaylord Submittal Drawings.
3. Each Ventilator section has a full length Rear Mounting Bracket at the rear for bolting to the wall and/or hanging from the overhead. There are two other full length hanging brackets; the Middle Mounting Bracket and the Front Mounting Bracket for hanging from the overhead (refer to Figure A-2-1). All three Hanging Brackets have pre-punched holes for hanging from the overhead. Hanging rods to be supplied by the Ventilator installer. If the rear bracket is used for bolting to the wall the holes must be drilled by the installing contractor at a support point in the wall. Refer to Table T-C-2-1 for minimum number of mounting points.
4. It is recommended that the number of hanging rods used be no less than the recommend minimum as shown on Table T-B-2-1.
5. The Ventilator(s) must be installed at the distance from the finish floor and the minimum side overhang dimension from the end of the Ventilator to the cooking equipment as shown on the Gaylord Submittal Drawings.
6. When there is a continuous Ventilator made up of two or more sections it is recommended that each Ventilator section is hung individually. Angles are provided at the top of the sections for bolting together. The bolts are provided by Gaylord. Hem strips and bolts are provided by Gaylord for joining the Ventilators on the underside where visible.

Installation Requirements – Cont.

7. **Caution:** When installing Ventilators do not cover the Main Electrical Raceway Ventilation Fan inlet and outlet Ventilation Snorkels, located on top of the Ventilator, with building insulation. Covering these openings will cause the raceway to overheat which could result in failure of electrical components. Covering the Ventilation Snorkels will void the Ventilator Warranty.

Table T-B-2-1

Recommend Minimum Mounting Devices					
Rear Mounting Bracket, Bolting to Wall or Hanging With Rods		Middle Mounting Bracket Hanging Rods		Front Mounting Bracket Hanging Rods	
Max. Distance From End of Ventilator Section	Max. Spacing Between Supports	Max. Distance From End of Ventilator Section	Max. Spacing Between Supports	Max. Distance From End of Ventilator Section	Max. Spacing Between Supports
12"	72"	36"	72"	12"	72"

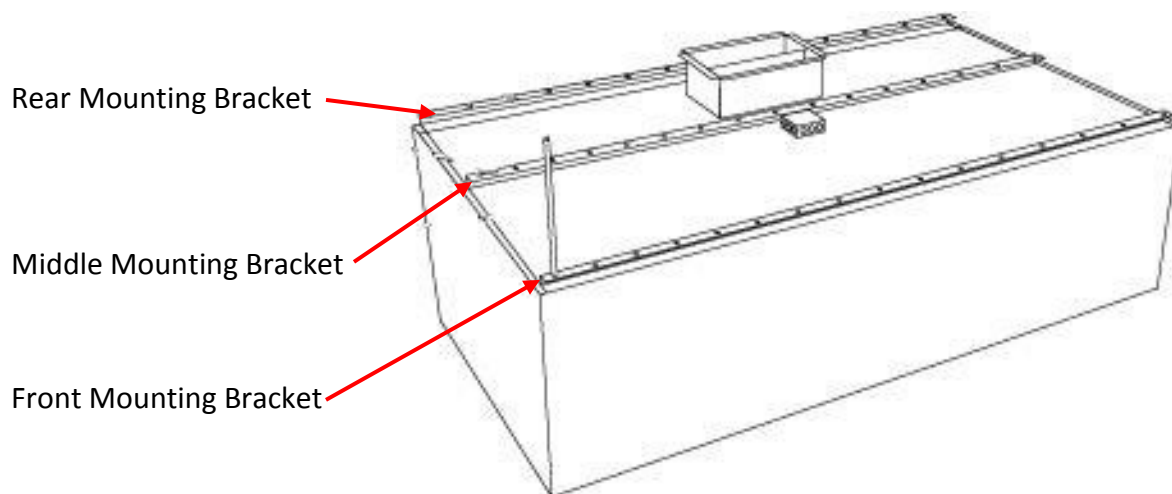

Figure B-2-1
Ventilator Hanging Points

Installation Requirements – Cont.

Ductwork

Grease exhaust ducts must be installed in compliance with NFPA-96, IMC and other applicable codes. Use the following guidelines when installing the exhaust ducts:

1. Exhaust ducts must be constructed of 16 gauge steel or 18 gauge stainless steel.
2. Exhaust ducts must be constructed with continuous external welds and be grease and water tight.
3. Exhaust duct must be continuously welded to the Ventilator duct collar.
4. All elbows should be sweeping 90's. Right angle turns or elbows less than sweeping may negatively impact the performance of the Ventilator.
5. All horizontal ducts should slope towards the Ventilator and/or towards an approved sump. Amount of slope must be in accordance with the IMC or UMC.

Electrical

Refer to the wiring diagrams on the Gaylord Submittal Drawings for specific wiring interconnections.

1. Command Center Electrical Power - Provide a 120 volt 20 amp service to the Gaylord Command Center. Optional Voltage 220 volt 50/60 Hz.
2. Wire the Command Center to the exhaust and supply fan(s).
3. Control Wires - The Ventilator is supplied with a flex conduit with 7 wires and ground extending 6 ft. beyond one end of the Ventilator. Wire to the Command Center in accordance with the electrical diagram.
4. If the Ventilator is built in multiple sections, and if they contain electric dampers, thermostats, or Autostart option, reconnect the flex conduit provided at the section breaks. The electrical contractor is responsible for making these connections.
5. Light Fixtures Electrical Power - If the Ventilator is provided with light fixtures, it is supplied with a flex conduit with 2 wires and ground extending 6 ft. beyond the end of the Ventilator. Connect to a switched lighting circuit as shown on the kitchen electrical plans. Ventilator may be equipped with built-in light switch.
6. Ventilators built in multiple sections have a flex conduit at the section breaks for interconnecting the light fixture J-boxes. The electrical contractor is responsible for making these connections.
7. UV System Electrical Power – Each Ventilator section is supplied with a flex conduit with 2 wires and ground extending 6 ft. beyond one end of the Ventilator. Wire to a separate 120 volt 20 amp service.
8. UV System Control Wiring - The Ventilator is supplied with a flex conduit with 5 wires and ground extending 6 ft. beyond one end of the Ventilator. Wire to the Command Center in accordance with the electrical diagram.
9. Ventilators built in multiple sections have a flex conduit at the section breaks for interconnecting the UV System control wiring. The electrical contractor is responsible for making these connections.
10. The UV Lamp Modules are shipped with the Ventilator in individual boxes. They are installed, and tested by a Gaylord Certified Representative at the time of initial Start Up and Demonstration. Store the UV Lamp Module boxes in a safe and secure area.

Installation Requirements – Cont.

Plumbing

Refer to the plumbing diagrams on the Gaylord Submittal Drawings for specific plumbing sizes, and plumbing interconnections.

1. Provide a hot supply to the Wash Control Cabinet. Note: water temperature requirements 140° F. Min. to 180° Max., water pressure requirements 40 psi Min. to 80 psi Max.
2. Plumb one line, size as shown on the Gaylord Submittal Drawings, from the Wash Control Cabinet to the connection points on top of each Ventilator section.
3. Run a drain line from the Ventilator drain stub out to a floor sink, or direct connect, as specified. Some Ventilators built in multiple sections the drains may interconnect. The plumbing is contractor is responsible for making these connections.
4. Run a drain line from the drain stub out on the bottom of the Wash Control Cabinet to a floor sink, or direct connect, as specified.

Air Flow Rates

The exhaust air flow rate (and supply if part of the Ventilator) must be set at the rate stamped on the Ventilator nameplate. The exhaust volumes (and supply when provided) were established under controlled laboratory conditions and greater exhaust and/or lesser supply may be required for complete grease, smoke and vapor removal in specific situations.

Fire Extinguishing System

NFPA-96 requires a Fire Extinguishing System in all Ventilators that cover grease producing cooking equipment. In many cases the Fire Extinguishing System is pre-piped by Gaylord Industries in the factory with completion of the system by a local Fire System contractor. If not pre-piped then the entire system would be installed by a local Fire System contractor. Use the following guidelines:

1. Fire Extinguishing System furnished must be in accordance with the terms of its listing and the applicable NFPA or IFC codes and standards.
2. Caution: Fire extinguishing system piping installed on the Ventilator at jobsite should be coordinated with the Gaylord Industries to ensure piping does not interfere with the Ventilator's operation and performance. Improper installation may void Listings of the Ventilator.
3. IMPORTANT NOTE: NFPA-96 requires that all gas cooking equipment, and electric cooking equipment that is protected by a Surface Fire Extinguishing System must automatically shut off upon activation of the system.
4. Most building departments require a separate Fire Extinguishing System permit from any other general building or Ventilator permit. Installing contractor to check with local building departments for their requirements, and to obtain necessary permits.

Ventilator Start-Up Inspection and Tests

Overview

As one of the benefits of purchasing a Gaylord CG3-UVi Series Ventilator is a complete Start-Up Inspection and Test is performed by a Gaylord Authorized Representative or a Gaylord Certified Service Agency. These tests must be conducted prior to use by the operator. Typically at the time the Start-Up Inspection is performed, the operation and general maintenance of the Gaylord equipment is demonstrated and described to the operating personnel. It is the responsibility of the Gaylord Authorized Representative or Agency to coordinate the date of Start-Up with any personnel such as the GC, owner, owner's rep, Fire Marshall, fire protection contractor, air balancer etc., required to witness the Start-Up.

For the CG3-UVi Series Ventilator the Authorized Representative or Agency uses the form titled Ventilator Start-Up Inspection and Test Report for Model CG3-UVi Series Ventilators, as shown on page C-3 of this manual.

Pre Start-Up Requirements

Before a Gaylord Start-Up can be performed, the responsible contractor or dealer must have the Ventilator installed and operating. The following is a check list of items that must be completed prior to a Start-Up being conducted.

Pre Start-Up Check List

- ___ Ventilator is installed above cooking equipment as per Gaylord Submittal Drawings.
- ___ The exhaust ductwork is connected to the Ventilator and the exhaust fan.
- ___ The supply ductwork is connected to the ceiling diffusers and the make-up air fan (system).
- ___ The exhaust fan is operational and is running in the correct direction.
- ___ The make-up air system is operational.
- ___ All required electrical connections between the Gaylord Command Center and the Ventilator, Building Management Systems, Remote Monitoring Systems, and Fire Extinguishing Systems are completed per plans and operational.
- ___ Ventilators built in multiple sections are inter-wired.
- ___ The Ventilator lights are wired and operational.
- ___ Hot water supply is connected to the Wash Control Cabinet.
- ___ Hot water line from the Wash Control Cabinet to the Ventilator(s) are connected and operational.

Ventilator Start-Up Inspection and Tests – Cont.

- ___ Ventilators built in multiple sections the hot water interconnections between sections are complete.
- ___ All drain(s) are plumbed to the floor sink or other drain.
- ___ Fire Extinguishing System installed and certified.

Ventilator Start-Up Inspection and Test Report

For Gaylord Model CG3-UVi Series Ventilators

Facility Name			Gaylord Representative Company Name		
Address			Gaylord Representative Name		
City	State	Zip	Signature		
Facility Contact Phone #			Date of Start-Up	Gaylord File Number	
Facility E-Mail					

Overview

Model CG3-UVi Series contain UV Lamps and therefore the Start Up Inspection and Test Report must be performed by a Gaylord Certified Service Agency (CSA). UV Lamp Modules are shipped in separate boxes from the Ventilator. The CSA installs the UV Modules when performing the Ventilator Start-Up Inspection and Test Report. Instructions to the CSA; complete this form for all Ventilator sections controlled by a single Command Center.

Installation of UV Lamp Modules

1. Open the UV Module Access Doors, remove the Blocking Plates and slide in the UV Lamp Modules. Install the 8 holding nuts and tighten to 7-9 in-lbs. Yes No
2. Connect the Lamp / Ballast Connector Plug. Yes No
3. Close the UV Module Access Doors and latch.
4. Open the Extraction Chamber Access Doors, all Particulate Separators are in place Yes No

Exhaust Volume Readings

1. Check to make sure all Extraction Chamber Access Doors are closed and latched.
2. Push the **START FAN** button on the Gaylord Command Center. The exhaust fan should come on. Note; if the Ventilator is a standard CG3-UVi Series (includes electric damper) it will take up to 45 seconds for the damper to open to the exhaust and the exhaust come up to 100%. Did the exhaust fan come on. Yes No
3. Determine the exhaust volume for each Ventilator section by following the instructions on Page 6-1 Record all readings in the Exhaust Volume Chart on Page 2 of 4. Record the Design CFM from the Gaylord Drawings or the Ventilator Nameplate. If the installation includes a Plenum Box make-up air system, take velocity readings and record on the chart.

Ventilator Start-Up Inspection and Test Report

For Gaylord Model CG3-UVi Series Ventilators

Exhaust Volume Chart - Example											
Item No.	Ventilator Description	Length	Ventilator Serial #	Make-up Air Plenum Box FPM	Inlet Slot Ht.	Inlet Velocity			CFM/Lin Ft. Design	Total CFM	
						Design	Actual	% Design		Design	Actual
K-112	Griddle Fryer Line	10'-0"		125	Std - 3"	1380	1270	92%	250	2500	2300
K-114	Broiler Line	16'-0"		110	Enl - 4"	1780	1810	102%	400	6400	6464

Exhaust Volume Chart											
Item No.	Ventilator Description	Length	Ventilator Serial #	Make-up Air Plenum Box FPM	Inlet Slot Ht.	Inlet Velocity			CFM/Lin Ft. Design	Total CFM	
						Design	Actual	% Design		Design	Actual

Make-Up Air

1. When the Exhaust Fan is on the Make-Up Air should be on. The Make-Up air on. ... Yes No
2. Type of Make-Up Air discharge.
 - Ceiling Registers located approximately _____ ft. in front of Ventilator.
 - Ceiling Plenum Box located immediately in front of Ventilator. Dimension from bottom edge of the Ventilator to discharge screen of Plenum Box. _____
 - Ceiling Plenum Box located approximately _____ ft. in front of Ventilator.
 - Linear Diffusers or registers located approximately _____ ft. in front of Ventilator.
 - Other _____

Ventilator Start-Up Inspection and Test Report

For Gaylord Model CG3-UVi Series Ventilators

Wash Cycle Test

- 1. Gaylord Command Center Model # _____
- 2. The Gaylord Command Center Serial # _____
- 3. Push the **START WASH** button on the Gaylord Command Center. Check the following:
 - a. Exhaust fan shut off. Yes ___ No ___
 - b. UV System shut off. Yes ___ No ___
 - c. Damper closed to front of Ventilator, wash position, after 45 seconds (CG3-UVi and CG3-UVi-FDL only). Yes ___ No ___

Ventilator Check

- a. Water sprays come on. Yes ___ No ___
- b. Any water leaks. Yes ___ No ___

Command Center Check

- a. Command Center displays that the Ventilator is in a Wash Cycle. Yes ___ No ___
- b. Length of Wash Cycle programmed for Min.
- c. If sequential Wash Cycle, delay between Wash Cycles programmed for Min.
- d. If sequential Wash, record the length of the Wash Cycle for each sequence;

Length of Wash Cycles (for sequence wash)			
Item #	Ventilator Description	Sequence #	Length of Wash Cycle in Min.

Wash Control Cabinet Check

- a. Any water leaks Yes ___ No ___
- b. Detergent pump is primed and pumping Yes ___ No ___
- c. Water pressure is: (40 psi Min. to 80 psi Max.) psi
- d. Water temperature is: (140° F. Min. to 180° F. Max.) ° F.
- e. Brand of detergent used

Conclusion of Wash Cycle Check

- a. At conclusion of the wash the water shut off Yes ___ No ___
- b. Did the damper stay closed in the forward position (CG3-UVi and CG3-UVi-FDL only).
..... Yes ___ No ___

Ventilator Start-Up Inspection and Test Report

For Gaylord Model CG3-UVi Series Ventilators

Internal Fire Mode Test

Important Note: This test only applies to the standard Model CG3-UVi. If the Ventilator Model number includes FDL, FDT, FDD, or ND no test is required. Proceed to next test.

Caution: Performing this test may set off the building fire alarm system and may notify the fire department. Notifying building management/maintenance and disabling the building alarm system is necessary.

The standard model CG3-UVi Ventilator has a damper at the air inlet slot and includes a thermostat, that when activated by high heat or fire, closes the damper to the fire position. This is called an Internal Fire Mode.

To test the Internal Fire Mode, push the Fire Mode Test button on the Gaylord Command Center. The following should occur:

- 1. The exhaust fan shut off. Yes No
- 2. The make-up air shut off. Yes No
- 3. The damper closed to the rear, the Fire Mode position. Yes No
- 4. The Wash Sprays should be off. Off On
- 5. The UV System shut off. Yes No
- 6. Gaylord Command Center screen displays that there is a fire in the Ventilator. Yes No

UV System Check

To test the UV System start the exhaust fan and check each Ventilator section for the following:

- 1. The Green UVi SYSTEM ON light on each Ventilator Section came on. Yes No
- 2. The Yellow UVi LAMP FAILURE light on each Ventilator Section is not on. Yes No

Caution: For tests #3 and #4 eye protection must be worn.

- 3. With the fan on open one UV Module Access Door.
- 4. With the fan on open a Ventilator Extraction Chamber Inspection Door. The Green UVi SYSTEM ON light shut off and the Blue UVi SYSTEM STANDBY light came on. Yes No
- 5. With the fan on open a UV Module Access Door. The Green UVi SYSTEM ON light shut off and the Blue UVi SYSTEM STANDBY light came on. Yes No

Installation Includes the Following Equipment

- Gaylord Autostart Control.
- Gaylord ClearAir Pollution Control Unit. (RSPC)
- Gaylord Distributor. (UDS)
- Fire Extinguishing System. Manufacturer _____

Ventilator Start-Up Inspection and Test Report

For Gaylord Model CG3-UVi Series Ventilators

Instructions from the Gaylord Certified Service Agency to the Owner/Operator/End User

After the Inspection and Tests has been successfully completed, demonstrate and review the following with the Owner/Operator/End User.

- 1. Explain the Principles of Operation as shown on pages x and x. ____ (CSA Initial)
- 2. Review the Operator Maintenance and Cleaning Instructions as described on page. ... ____ (CSA Initial)
- 3. Explain that the Ventilator and UV System must be on a scheduled maintenance program, in accordance with NFPA-96, and that it can only be performed by a Certified Service Agency. ____ (CSA Initial)
- 4. Explain the hazards of UV light if the Owner/Operator/End User services the UV System. ____ (CSA Initial)
- 5. Provide a copy of the Gaylord Technical Manual for the CG3-UVi Series Ventilator. ____ (CSA Initial)
- 6. Provide a copy of the Gaylord Command Center Technical Manual. ____ (CSA Initial)
- 7. Provide a copy of this Start-Up Inspection and Test Report. ____ (CSA Initial)

Note to Operator: You may obtain a free copy of the Gaylord Technical Manual for the CG3-UVi Series Ventilator and the Gaylord Command Center Technical Manual by visiting www.gaylordventilation.com.

Owner/Operator/End User Acknowledgement

Please sign this form to acknowledge that the Gaylord Certified Service Agent has thoroughly explained items 1 through 4 above, and provided documents listed in items 5 through 7 above.

Signature _____

Print Name _____

Company Name _____

Title _____ Date _____

Comments

This Page Intentionally Left Blank

Limited Warranty

For Model CG3-UVi Series Ventilators

Effective April 1, 2014

The Gaylord Ventilator and component parts furnished with the Gaylord Ventilator are warranted to be free from defects of material and workmanship under normal use when installed, operated and serviced in accordance with factory recommendation.

The Manufacturer's obligation under this warranty and any warranties implied by law shall be limited to repairing or replacing at its option any part of said equipment when either Gaylord Industries, or the Licensed Gaylord Manufacturer's examination shall disclose to its satisfaction to be thus defective, for a period of one (1) year from the date of beneficial use, or eighteen months from date of shipment, whichever occurs first, provided proper and acceptable evidence of such is recorded at the factory. GAYLORD INDUSTRIES AND THE LICENSED GAYLORD MANUFACTURER SHALL NOT BE RESPONSIBLE FOR INCIDENTAL OR CONSEQUENTIAL DAMAGES RESULTING FROM A BREACH OF THIS WARRANTY.

In the United States, the labor required to make repairs and replacements under this warranty shall be furnished by Gaylord Industries or the Licensed Gaylord Manufacturer or its authorized representative. Such labor shall only be provided Mondays through Fridays during the hours between 8 a.m. and 4 p.m. Requests for repairs or replacement parts should be made to GAYLORD INDUSTRIES, 10900 SW AVERY STREET, TUALATIN, OR 97062, USA. Phone 503-691-2010, or 800-547-9696.

Outside the United States, all replacement parts furnished under this warranty shall be F.O.B. Gaylord Industries, Tualatin, Oregon U.S.A. The owner shall pay the necessary freight delivery charges, and necessary labor for removal and installation of parts, and any tariffs, duties or all taxes.

Component parts not manufactured by Gaylord Industries such as electrical switches, relays, solenoid coils, etc., shall be warranted under the terms and conditions of the warranty that is published by the manufacturer of said component parts.

This warranty does not cover routine maintenance and inspection of the cleaning system as spelled out in The Gaylord Ventilator Technical Manual. This warranty also does not cover malfunctions or improper operation caused by fluctuating electrical power or power surges.

This is the sole warranty with respect to the aforesaid items. NEITHER GAYLORD INDUSTRIES OR THE GAYLORD LICENSED MANUFACTURER OR ANY OTHER PARTY MAKES ANY OTHER WARRANTY OF ANY KIND WHATSOEVER, EXPRESSED OR IMPLIED, AND ALL IMPLIED WARRANTIES OF MERCHANTABILITY AND FITNESS FOR A PARTICULAR PURPOSE WHICH EXCEED THE AFORESAID OBLIGATIONS ARE HEREBY DISCLAIMED AND EXCLUDED FROM THIS AGREEMENT.

Service and Warranty Policies

1. No warranty work shall be performed on the product without a Purchase Order from Gaylord Industries, if financial reimbursement is to be requested.
2. No warranty shall be provided on equipment that has been started up and in operation for more the 90 days unless, a product maintenance schedule has been created and performed per the requirements of this technical manual.
3. Any, and all, wearable parts are not to be considered warranty items, regardless of installation date, unless previously authorized by the factory.

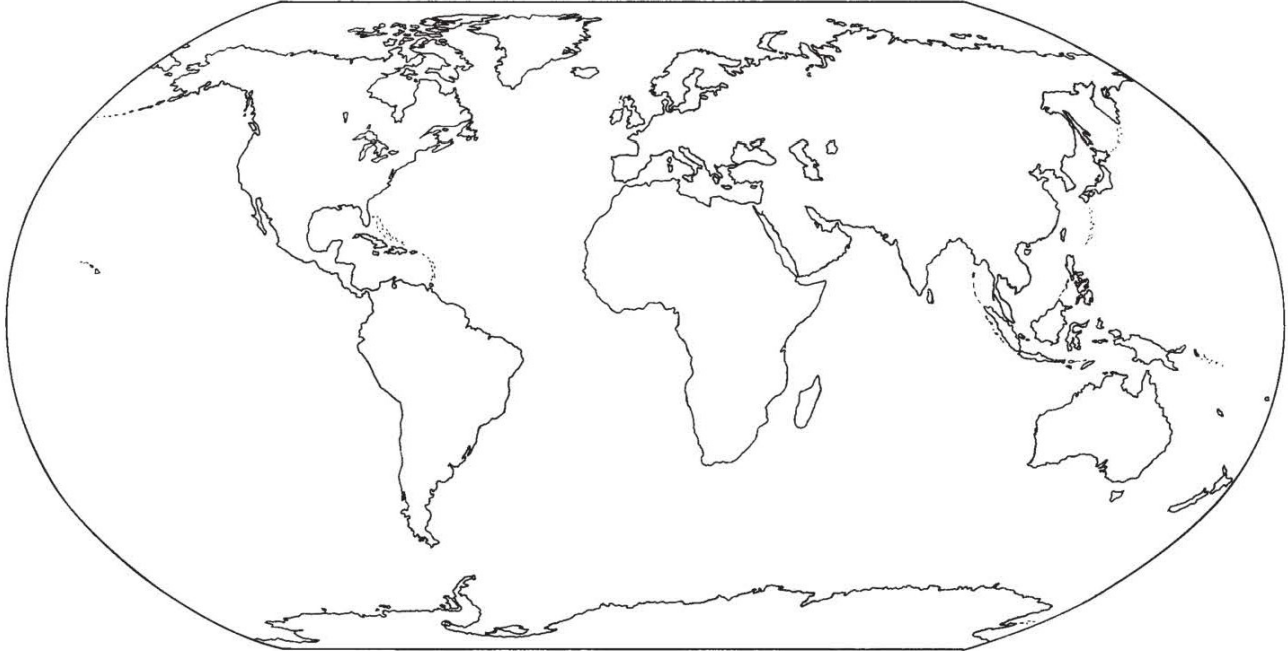

**WORLDWIDE SALES, MANUFACTURING AND SERVICE
FOR THE NAME AND LOCATION OF THE NEAREST
CERTIFIED SERVICE AGENCY, VISIT OUR WEB SITE:**

www.gaylordventilation.com

OR CONTACT US AT:

GAYLORD INDUSTRIES

10900 S.W. AVERY STREET
TUALATIN, OREGON 97062 U.S.A

email: info@gaylordventilation.com

Phone: 503-691-2010

800-547-9696

Fax: 503-692-6048

LOCAL SERVICE AGENCY