

# Operations & Service Manual

EOF SERIES  
Electric Fryers



Model: EOF-20/FFLT/24



Responsive. Reliable.

ISO 9001-2015 Registered • Committed to Quality

2750 Gunter Park Drive West • Montgomery, AL 36109 USA

Phone: 334.272.1457 • Toll Free: 800.554.4537 (USA & Canada Only)

Fax: 334.239.4117 • Website: [www.gfse.com](http://www.gfse.com)

Printed in USA, Form No. 60221 (Rel. Date: Nov.1999, Rev. Date: Oct.2017, Rev. G)

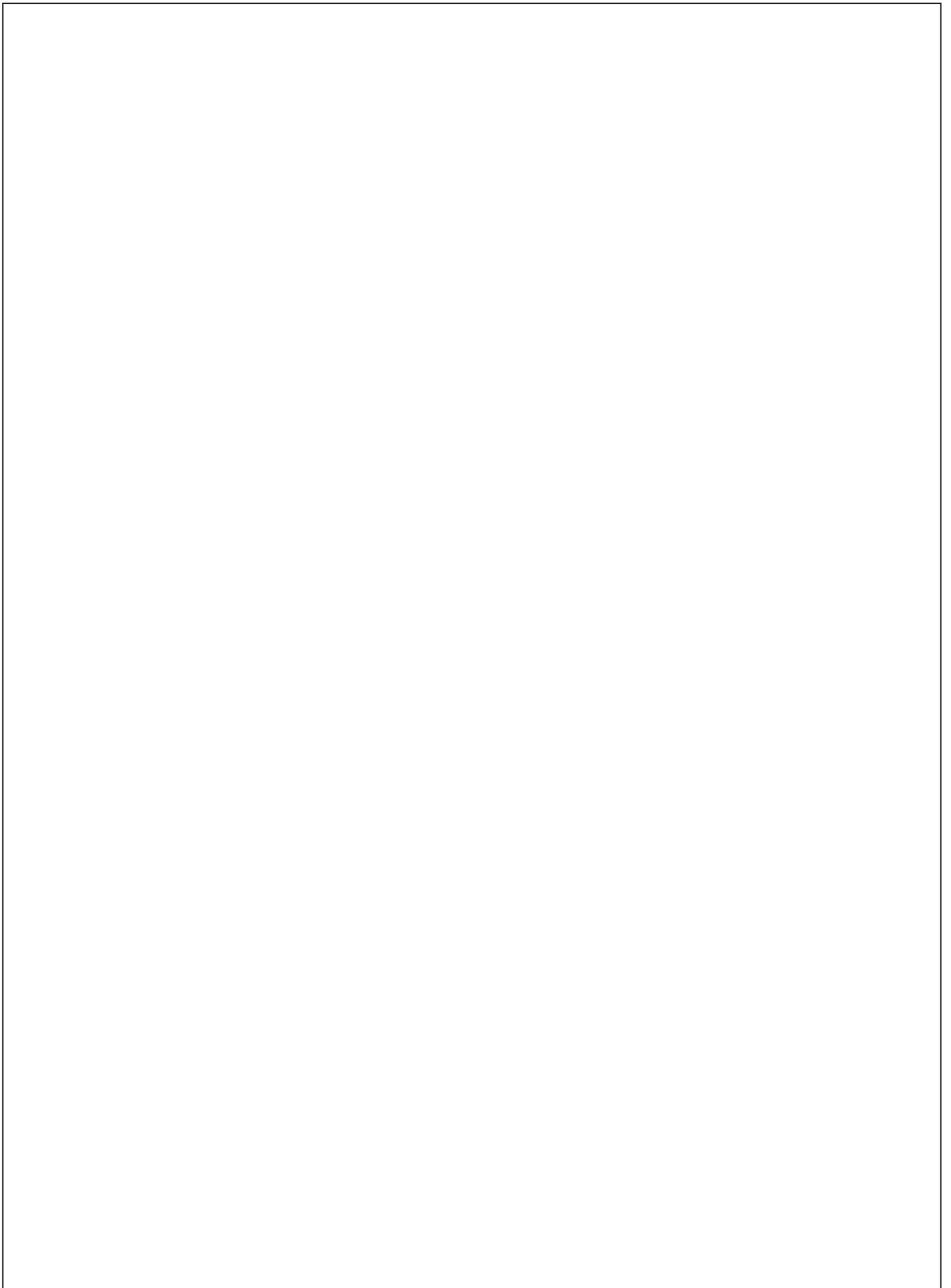



Responsive. Reliable.

## LIMITED WARRANTY

- Subject to the terms and conditions of this Limited Warranty as herein stated, all Giles Enterprises Inc. (hereafter referred to as "Giles") food service equipment and parts purchased new from an authorized Giles representative are warranted as to defects in material or workmanship for a period of twenty-four (24) months from the date of installation, provided, however, that with regard to labor costs in connection with this warranty, see below. All installations must be made by a qualified installing agency in accordance with all applicable codes and/or regulations in the jurisdiction in which installed. Limited warranty coverage is extended only to the original owner and is void if the unit is resold.
- During the Limited Warranty period, Giles will replace or recondition, at its factory, any part or parts of this unit which Giles inspectors judge defective, provided the unit has been properly installed, subjected to normal usage, and operated and maintained in accordance with specified procedures. This Limited Warranty does not cover cosmetic damage, and damage due to acts of God, accident, misuse, alteration, negligence, abuse, or use of unorthodox repair methods. All parts replaced under this Limited Warranty carry only the unexpired term of this Limited Warranty. Limited Warranty service may be furnished only by an authorized Giles service representative.
- If Limited Warranty service is requested, Giles will dispatch factory-authorized service representatives to inspect, repair, recondition, or replace units of its manufacture with such labor being rendered without cost to owner for twenty-four (24) months from the date of installation. Otherwise, service, including labor and transportation charges or other expenses, in connection with the removal or installation of any part or parts supplied under this Limited Warranty, are specified on the original sales contract between the purchaser and the authorized Giles representative.
- **Failure to use Giles OEM replacement parts and Giles OEM filters may void this Warranty.**
- Giles reserves the right to change or improve its equipment and/or parts in any way without obligation to alter such equipment or parts previously manufactured.
- Giles makes no further warranties, express or implied, including implied warranties of merchantability or fitness for a particular purpose, and has no other obligation or liability not specifically stated herein.
- Repair or replacement as provided under this limited warranty is the exclusive remedy. Giles shall not be liable for any incidental or consequential damages for breach of any express or implied warranty on this product, except to the extent prohibited by applicable law. Any implied warranty of merchantability or fitness for a particular purpose on this product is limited in duration to the duration of this limited warranty.
- Used Giles foodservice equipment or parts, or Giles foodservice equipment or parts not purchased from an authorized Giles representative, carry no warranties, express or implied.

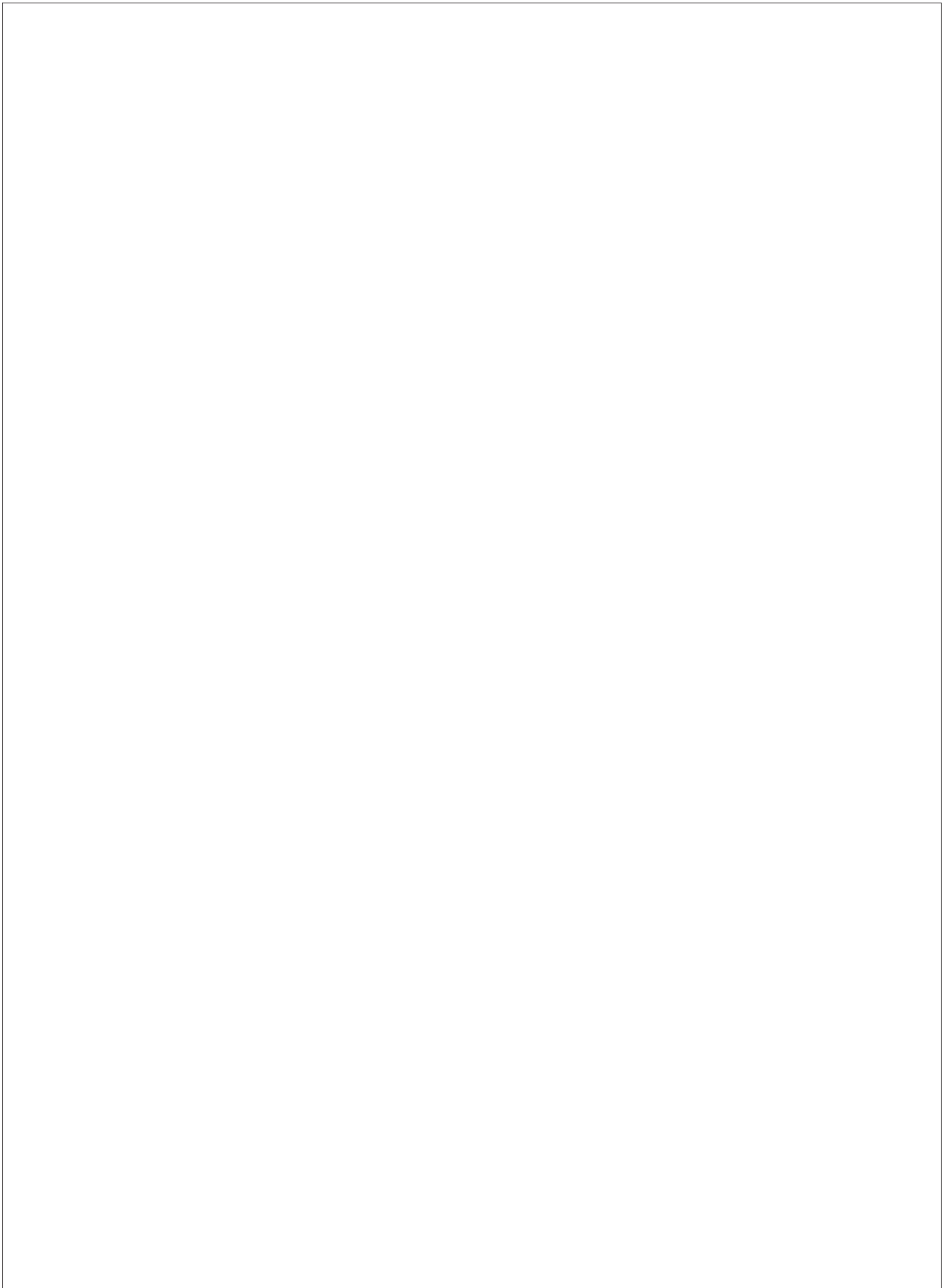

<b>Safety</b> .....	<b>vii</b>
Safety Overview .....	vii
Specific Safety Precautions .....	viii
<b>1. Introduction</b> .....	<b>1</b>
1.1. Construction .....	1
1.2. Standard Features .....	1
1.3. Optional Features .....	1
1.4. Specifications .....	2
1.4.1. Overall Unit Dimensions .....	2
1.4.2. Agency Certifications .....	3
1.4.3. Basket Size .....	3
1.4.4. Vat Size and Capacity .....	3
1.4.5. Shipping Specifications (Crated) .....	3
<b>2. Installation</b> .....	<b>5</b>
2.1. Appliance Location .....	5
2.2. Unpacking .....	6
2.3. Shipping Bars .....	7
2.4. Electrical Requirements .....	7
2.4.1. Electrical Specifications .....	8
2.5. Electrical Connections .....	8
2.5.1. Electrical Connection Diagram .....	9
2.6. Ventilation of Fryer .....	9
<b>3. Overview</b> .....	<b>11</b>
3.1. Baskets and Auto-Baskets Lifts (if installed) .....	12
3.2. Basket Hanger and Baskets (Fryer Unit without Lifts) .....	14
3.3. Control Panel (EOF10-10 Dual Display) .....	16
3.4. Control Panel (EOF-20 & EOF-24) .....	18
3.5. Control Panel (FFLT Dump Station) .....	20
3.6. Lower Cabinet (EOF10-10 Split Vat) .....	22
3.7. Lower Cabinet (EOF-20 & EOF-24) .....	24
3.8. FFLT Dump Station .....	26
3.9. FFLT Lower Cabinet (Filter Pan) .....	28
3.10. Filter Pan Assembly Detail .....	30
3.11. Accessories Included with Unit .....	32
3.12. Accessories Not Included with Unit (Purchased Separately) .....	35
<b>4. Installation Checkout &amp; Preparation</b> .....	<b>37</b>
4.1. Setup for Initial Checkout .....	37
4.2. Power Check .....	39
4.3. Heating Element Test .....	40
4.4. Filter Pump Test .....	41

4.5.	Perform Boil Out Procedure . . . . .	42
4.6.	Initial Cleaning . . . . .	42
<b>5.</b>	<b>Fryer Operation . . . . .</b>	<b>43</b>
5.1.	Computer Controller . . . . .	44
5.1.1.	Keys and Functions. . . . .	44
5.1.2.	Controller - General Operation . . . . .	46
5.1.3.	Setting the Cooking Temperature. . . . .	47
5.1.4.	Manually Setting the Cook Time. . . . .	49
5.1.5.	Working with Menus . . . . .	51
5.1.5.1	Editing a Menu Preset. . . . .	52
5.1.5.2	Selecting a Menu Preset for Cooking . . . . .	55
5.1.6.	Cooking Cycle - General Overview. . . . .	57
5.1.7.	Other Controller Features . . . . .	59
5.1.7.1	Manually Operating the Basket Lifts (If Equipped) . . . . .	59
5.1.7.2	COOL Mode. . . . .	60
5.1.7.3	AUTO-COOL Feature. . . . .	61
5.1.7.4	BOIL-OUT Mode . . . . .	61
5.1.8.	User Settings - Accessing & Editing . . . . .	62
5.1.9	PASSWORD Protection. . . . .	63
5.1.10	Power Up Procedure . . . . .	63
5.1.11	Controller Errors & Alarms . . . . .	64
5.1.11.1	Resolving Controller Errors & Alarms. . . . .	65
5.2.	Cooking Procedure . . . . .	66
5.3.	Filtering Used Cooking Oil . . . . .	71
5.4.	Removal of Waste Cooking Oil from Fryer. . . . .	74
5.5	<b>Optional</b> Renewable Filter Media Screen (SSFS) . . . . .	77
5.6.	Normal Shut-Down. . . . .	78
5.7.	Emergency Shut-Down . . . . .	78
<b>6.</b>	<b>Cleaning . . . . .</b>	<b>79</b>
6.1.	Boil-Out Procedure - Cleaning the Fry Vat. . . . .	79
6.2.	Cleaning the Filter Pan & Renewing Filter Media . . . . .	82
<b>7.</b>	<b>Troubleshooting. . . . .</b>	<b>84</b>
7.1.	Temperature Control System . . . . .	84
7.2.	Oil Filtration System. . . . .	86
7.3.	Basket Lift System (Only if Equipped). . . . .	87
<b>8.</b>	<b>Parts List . . . . .</b>	<b>89</b>
8.1.	Parts Ordering and Service Information. . . . .	89
8.2.	EOF-20 Front Header & Control Panel . . . . .	90
8.3.	EOF-24 Front Header & Control Panel . . . . .	92
8.4.	EOF10-10 Front Header & Control Panel. . . . .	94
8.5.	EOF10-10 Front Lower Cabinet. . . . .	96

8.6.	EOF10-10 Rear Upper & Lower Cabinet . . . . .	98
8.7.	EOF-20 Front Lower Cabinet . . . . .	100
8.8.	EOF-20 Rear Lower Cabinet . . . . .	102
8.9.	EOF-24 Front Lower Cabinet . . . . .	104
8.10.	EOF-24 Rear Lower Cabinet . . . . .	106
8.11.	FFLT Cabinet Front . . . . .	108
8.12.	FFLT Cabinet Rear . . . . .	110
8.13.	Filter Pan . . . . .	112



**Notes:**

---

## Safety

### Safety Overview:

The instructions contained in this manual have been prepared to aid in learning the proper procedures for installing, operating and servicing the **Giles Model GBF Series Electric Fryer**.

Throughout the manual, safety precautions are identified by a hazard alert symbol and key words such as **DANGER**, **WARNING** or **CAUTION**. Alert information precedes the tasks to which it applies. Suggested, recommended, or other noteworthy information is identified as **NOTES**, or will be noted as **IMPORTANT!**. Additionally, certain words are used to indicate a specific meaning, or to add emphasis as follows:

- Shall:** understood to be mandatory.
- Should:** understood to be advisory.
- May:** understood to be permissive.
- Will:** indicates a future event or condition to occur.

 **Hazard Alert Symbols** are used in conjunction with key words, such as **DANGER**, **WARNING**, or **CAUTION**, to alert Users to potential personal injury hazards and/or poor operating practices. These will immediately precede precautionary measures pertaining to avoiding such hazards or practices. Adhere to all information following these symbols to avoid possible injury, or even death. Failure to do so may also void the factory warranty.

#### **DANGER**

Indicates an imminently hazardous situation which, if not avoided, will result in serious personal injury, even death.

#### **WARNING**

Indicates a potentially hazardous situation which, if not avoided, could result in serious injury, even death.

#### **CAUTION**

Indicates a potentially hazardous situation which, if not avoided, may result in minor to moderate injury. This notification is also used as an alert to unsafe practices.

#### **CAUTION**

If used without the safety alert symbol, indicates a potentially hazardous situation which, if not avoided, may result in equipment and/or property damage, and may void the factory warranty.

#### **NOTE or IMPORTANT!**

Identifies suggested, recommended, or other important information.

## Specific Safety Precautions:

For your safety, please observe the following precautions when operating or servicing **EOF Electric Fryers**. Adhering to the following important safety precautions will help Users to avoid personal injury and/or damage to the equipment.

### **DANGER**

- Before cleaning or performing maintenance, place power switch in the **OFF** position. Unplug power cord or turn **OFF** power at the electrical panel supplying power to remove all power from the appliance.
- **DO NOT** wash down the Fryer interior or exterior with water spray.
- Failure to comply with **DANGER** notices will result in serious injury, even death; or damage to equipment and/or property and may void the factory warranty.

### **WARNING**

- Prior to installation, consult a qualified electrician to ensure that installation complies with all electrical requirements and codes.
- **The unit must be adequately and properly grounded. Improper grounding may result in electrical shock to User. Always refer to local electrical code to ensure proper grounding of this or any other electrical equipment.**
- **Check the rating label on the unit to determine the proper power supply required. Always consult with an electrician, or other qualified service technician, to ensure that circuit breakers and wiring are of sufficient rating and gauge to power this equipment. A Wiring Diagram has been provided with the unit as an aid for technicians. Appliance must be installed and electrically grounded in accordance with local code, or in the absence of local code, in accordance with the National Electrical Code, NFPA 70.**
- Improper installation, adjustment, alteration, service, or maintenance could result in serious injury, even death; equipment and/or property damage; and will potentially void the factory warranty.
- **DO NOT** use or store flammable liquids, or materials that produce flammable vapors, in the vicinity of this or any other appliance!
- **DO NOT (or ALLOW OTHERS) for any reason, stand or step onto the top of the appliance.** Cooking oil in Fryers can be **EXTREMELY HOT (excess of 330°F [166°C])**. Bodily contact will cause extremely serious injury. Lids used to sometimes cover cooking vats/pots are not designed to, and **WILL NOT**, support the weight of a person. 
- Failure to comply with **WARNING** notices could result in serious injury, even death; damage to equipment and/or property; and will potentially void the factory warranty.

## CAUTION

- The appliance must remain in an upright position.
- Exercise care when removing the unit from shipping pallet.
- **DO NOT** operate the appliance, unless its components and their intended functions are fully understood (see **Section 3**). After reading and fully understanding **Section 3**, closely follow the presented procedures and instructions in order to avoid equipment damage or malfunction.
- **To avoid personal injury, it is recommended that thermal hand protection (gloves or mitts) be worn while tended the appliance.** Certain parts of the Fryer will become very **HOT** during operation; temperatures inside cabinet may exceed **150°F (65.5°C)**! Exercise caution when operating and cleaning.
- Placing foods containing excessive moisture into hot oil, or attempting to load larger than recommended batch sizes can cause a “surge boil” and result in an overflow of **HOT** cooking oil. Exercise due care when loading food by observing how oil is reacting before continuing.
- Be sure the appliance is positioned in a stable, safe location with the casters in the locked position. **DO NOT** operate appliance if not secured. Some jurisdictions may require special anchoring for this type appliance; check local code.
- Allow the appliance to cool for 15-20 minutes before cleaning or servicing.
- This appliance is not intended for use by persons (including children) with reduced physical, sensory, or mental capabilities, or lack of experience and knowledge, unless they have been given adequate instruction and/or supervision concerning its use by a person responsible for their safety. Children should not be allowed to play with, or around, this appliance.
- Prior to sale, cooked food products must be maintained at a minimum temperature of 150°F (65.5°C), or in accordance with governing health regulations.
- Failure to comply with **CAUTION** notices may result in minor to moderate personal injury, damage to equipment or property, and potentially void the warranty.

## CAUTION

- Components exposed on the Control Panel surface are impact-sensitive. To avoid damage and maintain proper operation, exercise care when working around or using carts/rolling tables near the appliance.
- **DO NOT** install the unit near combustible walls and materials. Failure to maintain safe distance may result in fire.
- When cleaning the appliance:
  - **DO NOT** steam clean.
  - **DO NOT** use products containing chlorine, or other corrosive chemicals.
  - **DO NOT** use abrasive products, steel wool or scouring pads.
  - **DO NOT** use oven cleaners.
- **DO NOT** alter, add attachments, or otherwise modify this equipment!
- Failure to comply with **CAUTION** notices may result in damage to equipment or property, and void the factory warranty.

## NOTE:

- Users must comply with all appropriate state and/or local health regulations regarding food service operations, and cleaning and sanitization of food service equipment.

## 1. Introduction

**THANK YOU** for purchasing the **Giles EOF Series Fryer**, manufactured by *GILES Food Service Equipment*; Montgomery, Alabama (USA), hereafter referred to as "Giles". **EOF Series Fryers** are high-volume banked units with either two (2), three (3) or four (4) wells, in combinations of 10", 20" and 24" wide. Every unit is thoroughly inspected and tested prior to shipment in efforts to ensure that it will operate flawlessly when received. With proper care and maintenance the appliance will provide years of trouble-free service.

To help protect your investment in this state-of-the-art cooking equipment, we recommend that you take a few moments to become familiar with the installation, operational, cleaning, and maintenance procedures contained in this Manual. Adherence to these recommended procedures will minimize the potential for costly "downtime" and future repair expense. Please retain this manual for future reference.

**NOTE:** Due to continuing improvements and product enhancements, some of the illustrations shown in this manual might not exactly depict current models.

### 1.1 Construction

Appliance exterior cabinet and fry vats are constructed of 430 Series Stainless Steel of applicable gauge.

### 1.2 Standard Features

**Computer Controller:** Controls cooking oil temperature and cook time (separate timer for each Basket). Features fifty (50) programmable Menu Item cooking presets. Monitors fryer status, and displays various operational warnings (DRAIN OPEN, MAX ELEMENT TEMP, etc.) and operational instruction prompts. Features BOIL-OUT program, COOL-MODE, FORCE FILTER function, available password security, and multiple language selections. Controller displays operational instructions to ensure smooth operator interface.

**Built-in Oil Filtration System:** Completely self-contained; helps to extend the life of cooking oil. Designed to perform a filter cycle within approximately five (5) minutes. Service each fryer well in the battery.

**Dump Station (FFLT - Fried Food Landing Table):** Built-in dump station; convenient location to dump product for draining after cooking. Oil drainage is returned to the Filter Pan underneath.

**10-10 Split Vat:** EOF10-10 Models feature one fryer unit with a split cooking vat, providing two (2) completely separate 10" wells for cooking different food types, such as poultry and seafood, without significant cross-contamination of the cooking oil.

**Automatic Basket Lift:** Automatically lowers Basket at beginning of cooking cycle and lifts cooked product from hot cooking oil when programmed cooking time has expired. Helps prevent over-cooking. Standard feature on the 20" and 10" wells.

### 1.3 Optional Features

**Automatic Basket Lift:** Can be added as optional feature for 24" vats. Automatically lowers Basket at beginning of cooking cycle and lifts cooked product from hot cooking oil when programmed cooking time has expired. Helps prevent over-cooking.

1.4 Specifications

1.4.1 Overall Unit Dimensions

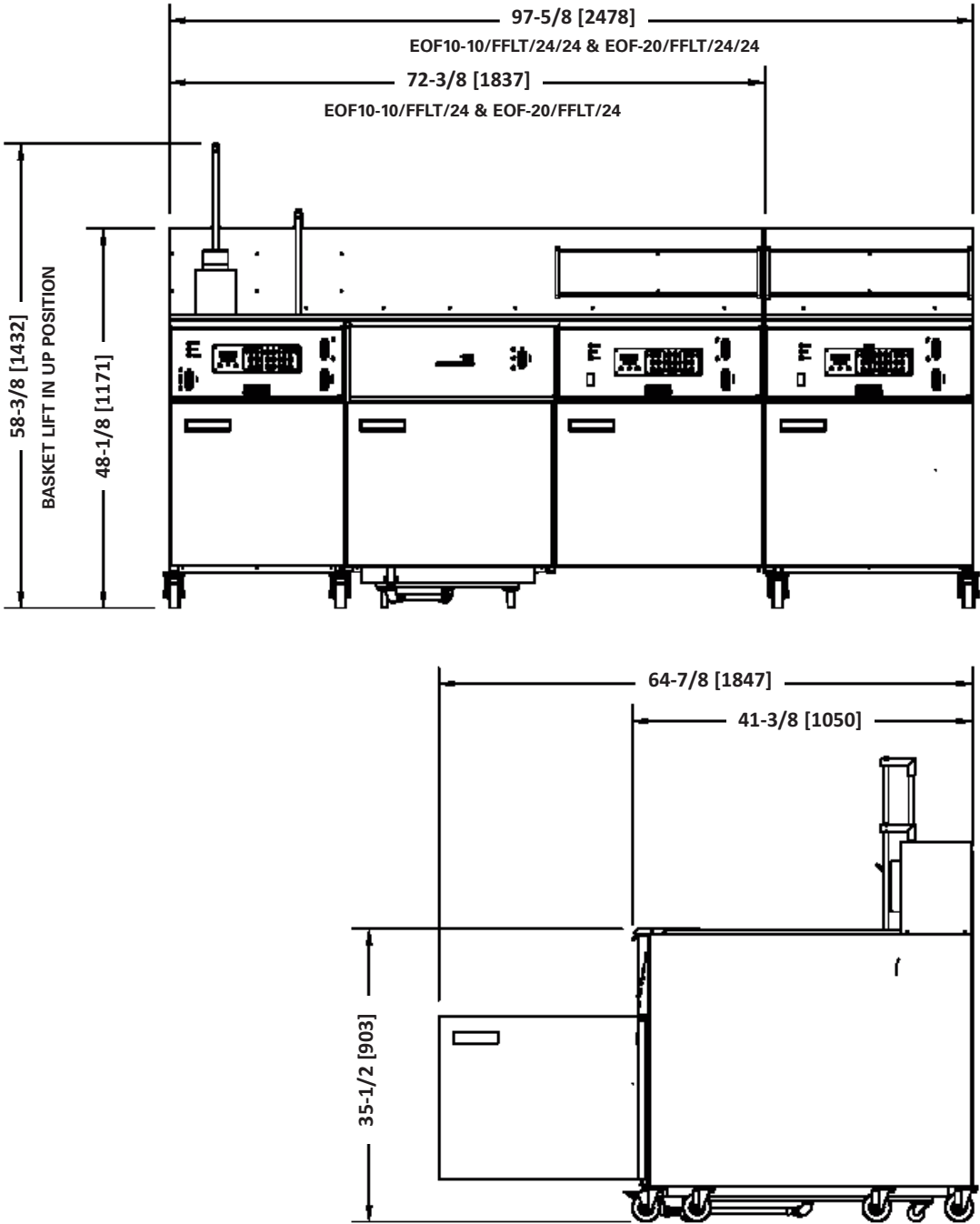

Inches [mm]

## 1.4.2. Agency Certifications



## 1.4.3. Basket Size (\* Optional)

Model	Length	Width	Depth	Volume
EOF10-10 / EOF-20	18-1/2" [469.9 mm]	9" [228.6 mm]	5-1/2" [139.7 mm]	811 cu in [0.013 c m]
EOF-24*	22-3/4" [587 mm]	11" [279 mm]	5" [127]	1,176 cu in [0.019 c m]

## 1.4.4. Vat Size & Capacity (each Vat)

Model	Length (Inside)	Width (Inside)	Depth (Top of Element to "FULL" Level)	Cooking Oil Capacity (Bottom of vat to "FULL" Level)	
EOF-10	20" [508 mm]	10" [254 mm]	4-1/2" [114 mm]	55 lbs [25 kg]	8 gals [30 l]
EOF-20	20" [508 mm]	20" [508 mm]	4-1/2" [114 mm]	110 lbs [50 kg]	16 gals [59 l]
EOF-24	24" [610 mm]	24" [610 mm]	4-1/2" [114 mm]	160 lbs [73 kg]	23 gals [86 l]

## 1.4.5. Shipping Specifications (Crated)

Model	Gr. Wt.	Crated Size			Cube
		Length	Width	Height	
EOF10-10/FFLT/24	1,071 lbs [486 kg]	108" [2,743 mm]	50" [1,270 mm]	61" [1,549 mm]	193.8 cu.ft [5.5 cu.m]
EOF10-10/FFLT/24/24	1,311 lbs [595 kg]	108" [2,743 mm]	50" [1,270 mm]	61" [1,549 mm]	193.8 cu.ft [5.5 cu.m]
EOF-20/FFLT/24	910 lbs [413 kg]	108" [2,743 mm]	50" [1,270 mm]	61" [1,549 mm]	193.8 cu.ft [5.5 cu.m]
EOF-20/FFLT/24/24	1,258 lbs [571 kg]	108" [2,743 mm]	50" [1,270 mm]	61" [1,549 mm]	193.8 .ft [5.5 cu.m]



## 2. Installation

The following section describes procedures necessary for proper installation of **EOF Series Fryers**. To avoid possible personal injury or equipment damage, please ensure these procedures are followed.

To ensure compliance with applicable building, health and fire codes, it is advisable that this appliance be installed by a professional kitchen equipment contactor, or service company. **All costs for installation, including materials, labor and fees are the responsibility of the customer.**

### 2.1. Appliance Location



**DO NOT MODIFY, ADD ATTACHMENTS OR OTHERWISE ALTER THIS EQUIPMENT**

1. Appliance and surrounding area must be free and clear of combustible materials. Maintain 3" [7.6 cm] clearance.
2. Allow for adequate space to allow easy access for future servicing and proper operation. Provide adequate ventilation in the operating area, as required.
3. Be sure that electrical service available in the intended location is of a voltage and amp rating adequate to power the appliance. **NOTE:** A banked battery requires a separate electrical service for each Fryer unit.
4. Be sure unit is to be installed on level floor, in a stable position and will not unintentionally move. Unit has locking brakes on front casters ... be sure they are locked. Some commercial codes may require that the unit be secured to an immovable structure (wall, etc.) by means of a restraining cable to restrict movement.
5. The appliance shall be installed, operated, and maintained in accordance with the **Standard for Ventilation Control, and Fire Protection of Commercial Cooking Operations, NFPA 96.**

These steps will help to ensure proper installation. If there are questions concerning these procedures, contact **Giles Technical Support** at **800.554.4537** or email **services@gfse.com**.

## 2.2. Unpacking

Fryer is shipped on a wooden pallet; secured with high-tensile plastic strapping and enclosed by wooden framework. The entire unit is wrapped in machine-applied stretch wrap. Certain auxillary items (Filter Pan, baskets, fryer tools, etc.) will be packed on top of the unit or contained inside the vats.

### CAUTION

- The appliance must remain in an upright (vertical) position during the unpacking process. Exercise care when lifting or moving the unit. Appropriate lifting equipment will be required to remove the unit from the shipping pallet. **DO NOT attempt to manually lift the unit, it is extremely heavy.**
- Exercise care when removing the wooden framework from around the unit.
- Failure to comply with these **CAUTION** notices may result in minor or moderate injury, equipment or property damage, and void the factory warranty.

### IMPORTANT!

If crate exhibited evidence of damage or mishandling, immediately inspect the unit and all accessory items and notify the freight carrier of any damages. Typically it is the purchaser's responsibility to file and negotiate freight damage claims.

1. Carefully cut and remove the plastic shipping wrap and strapping. Using appropriate tools remove the crating framework from the pallet and dispose of it properly
2. Filter Pan and Fryer accessories (Baskets, Screens, etc) are packed inside the Fryer Cabinet and Vat. Remove these items and set aside in a safe place.
3. Carefully remove the Fryer from the shipping pallet. Unit is extremely heavy. It is strongly recommended to use only motorized lift truck, equipped with **extended forks**, to lift the unit. Approach unit from the end and ensure that forks rest completely on the internal tubular framework. Slowly lift unit only high enough for casters to clear the pallet risers, then have helpers slide the skid from underneath the unit. Carefully lower unit to floor. Be sure all casters are unlocked; the Fryer bank can then be easily maneuvered manually.

### IMPORTANT!

**Giles shall not be liable for damages caused to the unit by improper use of material handling equipment or poor work practices. Giles shall not be liable for personal injury or property damage which may be incurred during installation of this equipment. Installation is the sole responsibility of the purchaser. Failure to follow these instructions could void the factory warranty.**

## 2.3. Shipping Bars

Reinforcement bars are attached to the framework, at the front and rear of the Fryer bank. These bars are provided as a stabilizing reinforcement during shipping and the installation process. Please note the following:

1. The bars must remain in place until the fryer is positioned in the designated final operating position.
2. Use the procedure previously recommended when removing unit from skid.

### CAUTION

Caution must be used when lifting the Fryer bank to be sure that piping, or other components on the underside of unit, are not impacted and damaged by lifting equipment or techniques.

3. After the Fryer unit is located in its final operating position, remove the front reinforcement bar. **IMPORTANT! Bar must be removed to allow installation of the Fryer Filter Pan.**
4. The rear reinforcement bar can remain in place and will not affect fryer operation.
5. Remove the front bar by removing all screws holding it to the unit framework. Note that the bar is fastened to the fryer at each of the vertical uprights.
6. It is advisable to note how the bar is attached, and retain it along with mounting hardware. In the event that the unit is moved to a different location in the future, the reinforcement bar should be reinstalled before it is moved.
7. After the front bar is removed, follow the instructions provided in this Manual for the remaining installation and operation of the equipment.

## 2.4. Electrical Requirements

### CAUTION

- Fryers must be properly grounded in accordance with local code, or in the absence of local code, with the National Electrical Code, ANSI/NFPA 70. Improper grounding may result in electrical shock to Users. Check local electrical code to ensure that proper grounding techniques are used.
- Always consult a certified electrician, or other qualified service technician, prior to installation to ensure that electrical circuits are of sufficient rating for the appliance load.
- EOF Fryers are manufactured for various Voltage/Hz/Phase shown in **Section 2.4.1** below. Check the Serial/Data Label inside the Cabinet or attached to the Rear Panel to determine the electrical service required for the Unit. **Each Unit in the banked battery requires a separate power service.**

## 2.4.1. Electrical Specifications (per Fryer Unit) \*EOF10-10 Total for Both Wells

Model	Voltage	Phase	Hz	Watts	Amps	Circuit Breaker Required
*EOF10-10	208	3	60	24,000	68	85
	480	3	60	24,000	33	45
EOF-20	208	3	60	24,000	76	80
	480	3	60	24,000	33	45
EOF-24	208	3	60	30,000	100	125
	480	3	60	30,000	43	55

## 2.5. Electrical Connections

**NOTE:**  
 Each unit in the Fryer bank requires a separate power supply.  
 All electrical installation materials (circuit breakers, conduit, wire, etc.) and installation labor shall be supplied by the customer. Work should be performed by a qualified electrician, or service technician.  
 Installation must comply with local code requirements. Giles shall not be responsible for code compliance with regard to installation and use of this appliance.

1. As needed, install appropriate circuit breaker(s) in main electrical panel. See **Section 2.4.1.**
2. **(Recommended)** Install a disconnect switch box between main panel and Fryer.
3. See **Figure 2.5.1.** Connect 1-1/4" flexible conduit from disconnect to the Fryer. Attach conduit to rear of the Fryer Service Box with appropriate conduit fittings. Allow enough length so that the Fryer can be moved easily for cleaning and servicing.
4. See **Figure 2.5.1.** Open Fryer Cabinet Door and remove Service Box Cover.
5. Connect a ground wire between the Ground Lug and a proper earth ground.
6. Route appropriately sized power wires from the disconnect box panel through to the front Service Box.
7. See **Figure 2.5.1.** Connect the supply power wires to Distribution Block located in the Service Box.
8. Reinstall Service Box Cover. Be sure all lugs are tight and secure.
9. Each Fryer unit in the battery will be connected in like manner.

## 2.5.1. Electrical Connection Diagram

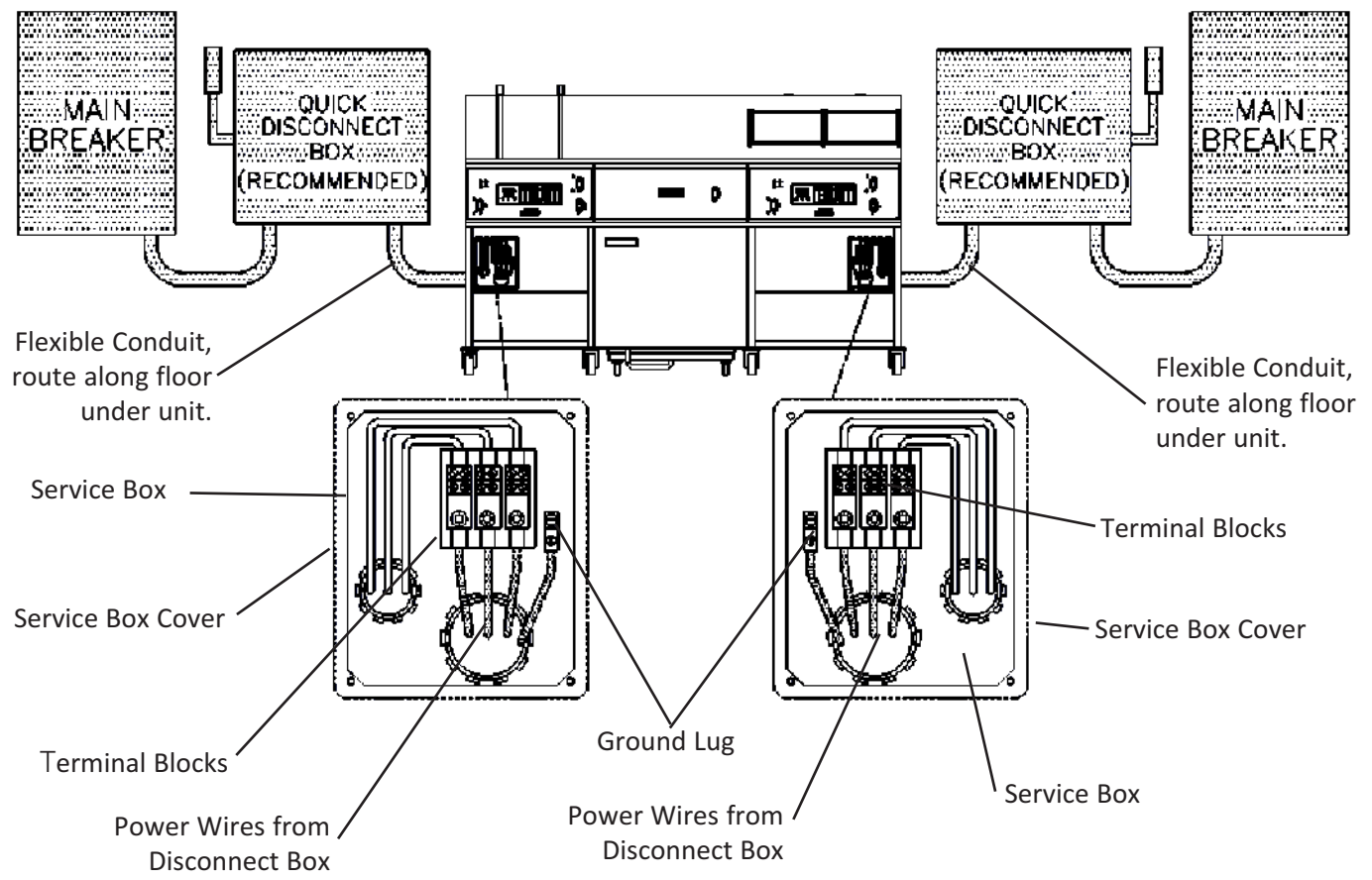

## 2.6. Ventilation of Fryer

**NOTE:**  
Guidelines and codes for ventilation system requirements may differ from locale to locale. Always consult with the local authorities having jurisdiction to ensure compliance.

Consult a professional ventilation or HVAC company for assistance in determining whether existing systems are sufficient to accommodate this equipment, or in designing a ventilation hood system to comply with local code requirements.



## 3. Overview

The following section provides a brief overview of the components, functions, and accessories associated with EOF Series Electric Fryers. Please review carefully before attempting operation.

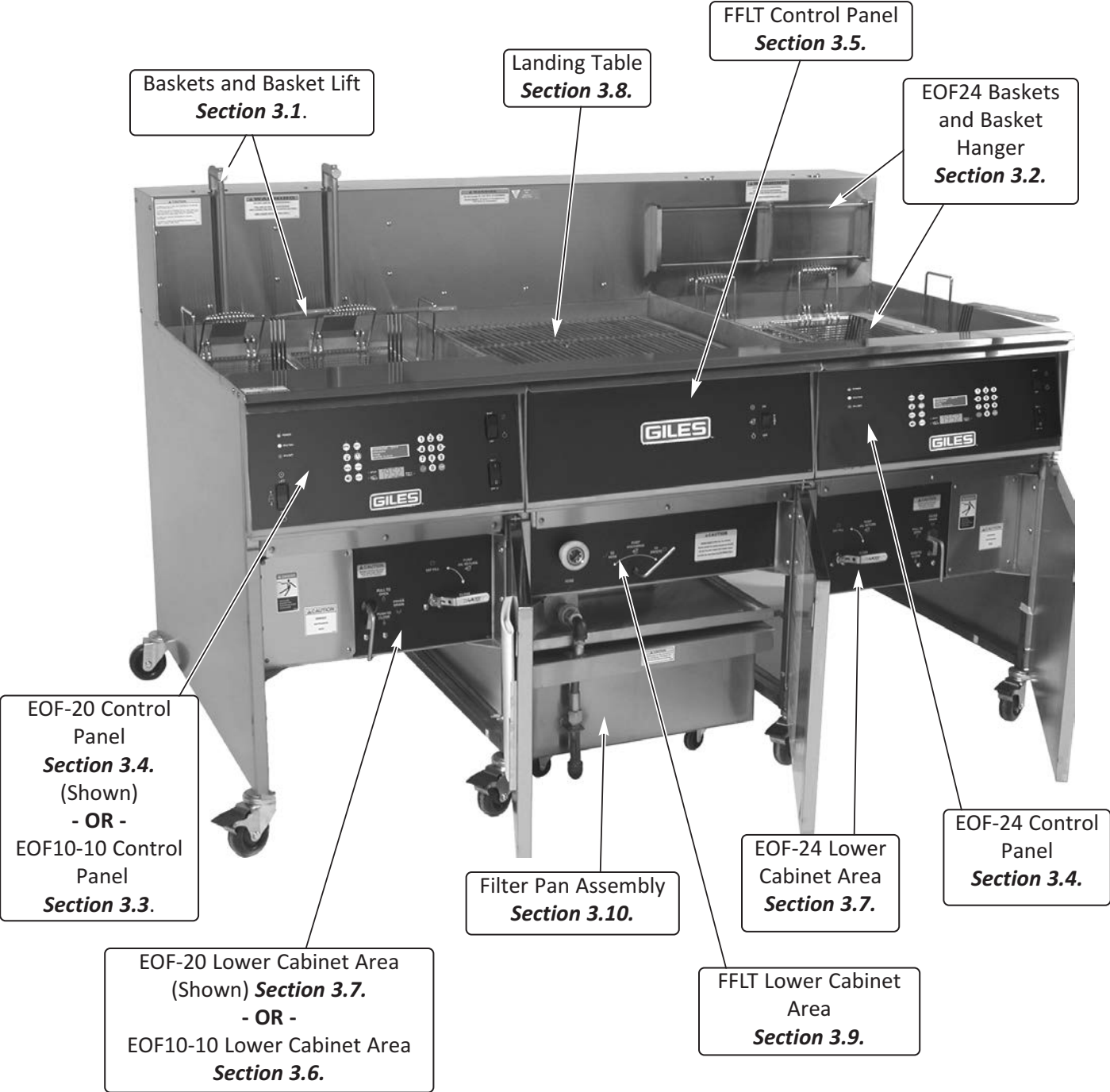

3.1. *Baskets & Auto-Basket Lifts (Optional for EOF-24)*

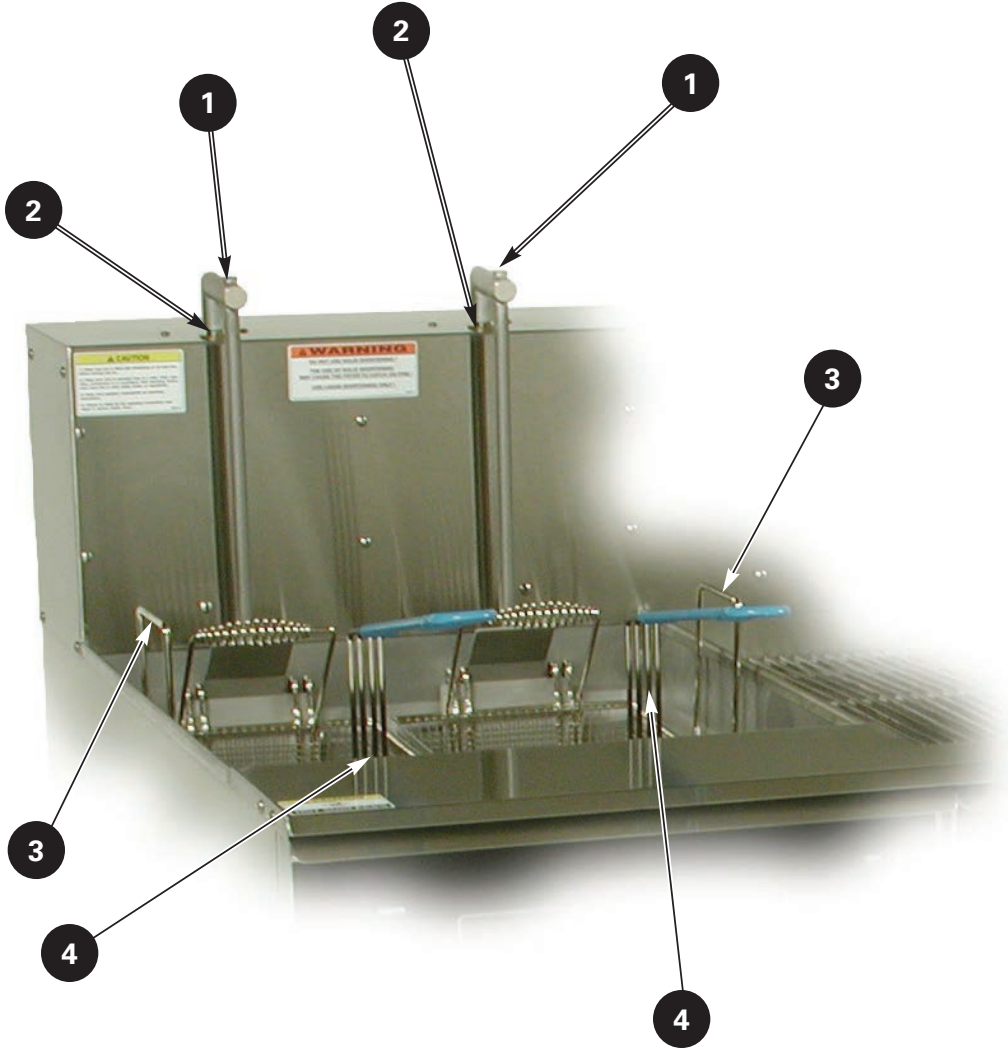

3.1. <i>Baskets &amp; Auto-Basket Lifts (Optional for EOF-24)</i>		
Item	Description	Function
1	Basket Carrier (2)	Attaches to the Basket Lift shaft and holds the Cook Basket for the automatic Basket Lift to lower and raise it into and out of the Fry Vat.
2	Basket Lift (2) (Hidden)	Automatically lowers and lifts the Basket into and out of the Fry Vat.
3	Crumb Screen	Placed inside the Fry Vat to prevent breading crumbs and cooking residue from accumulating around the heating elements. EOF10-10 contains two (2) small Screens.
4	Basket (2)	Contains food product while cooking.



Always wear thermal protection, such as Oven Mitts when handling any of these parts during normal operation ... they can become very hot!

## 3.2. Basket Hanger & Baskets (Fryer Unit without Lifts)

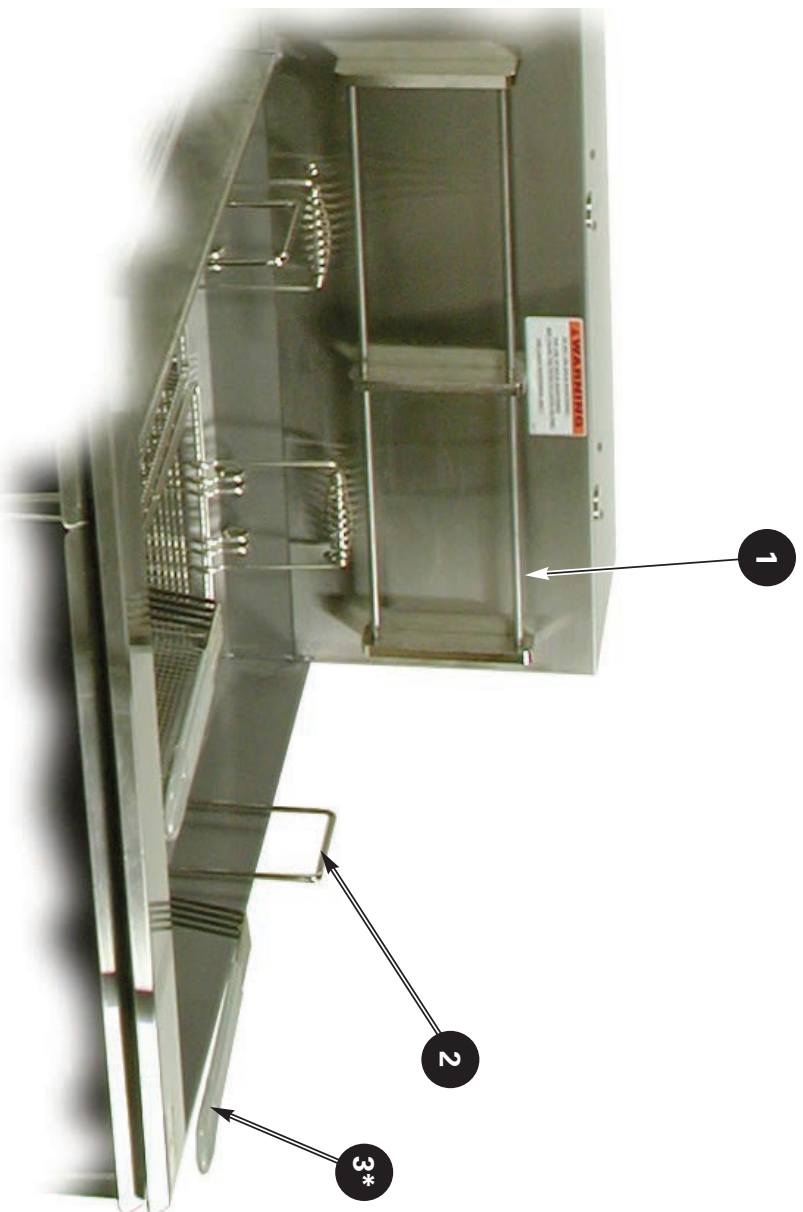

\* Optional for EOF24, not included as standard

3.2. Basket Hanger & Baskets (Fryer Unit without Lifts)		
Item	Description	Function
1	Basket Hanger	Holds Basket, allowing excess oil to drain from cooked product, or when loading food product for cooking.
2	Crumb Screen	Placed inside the Fry Vat to prevent breading crumbs and cooking residue from falling onto and accumulating around the heating elements.
3*	Basket (2)	Contains food product while cooking. <b>Not included as a standard item for the EOF-24 Fryer unit (must be purchased separately).</b>



Always wear thermal protection, such as Oven Mitts when handling any of these parts during normal operation ... they can become very hot!

\* Optional for EOF24, not included as standard

3.3. Control Panel (EOF10-10 Dual Display)

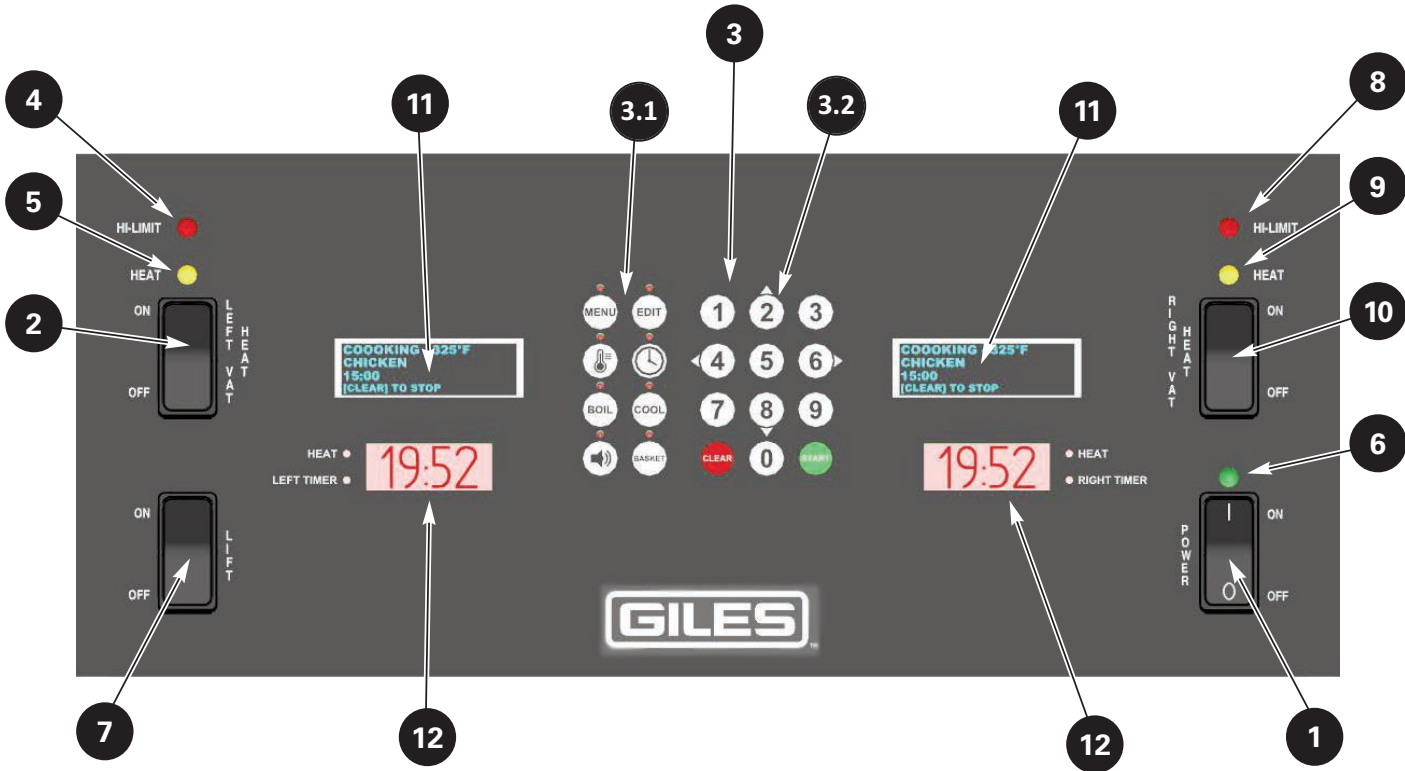

3.3. Control Panel (EOF10-10 Dual Display)		
Item	Description	Function
1	Power Switch	The Power Switch turns Fryer power <b>ON</b> and <b>OFF</b> .
2 / 10	Heat Switch (Left / Right Vat)	Heat Switch enables the heating elements. Place in <b>[OFF]</b> position to disable heat; when ready to heat oil (or boil-out), place in the <b>[HEAT]</b> position to enable elements . In certain circumstances elements will <b>NOT</b> turn <b>ON</b> even with switch in the <b>[HEAT]</b> position.
3	Computer Controller (Dual Display)	Monitors and regulates Fryer operation ... cooking oil temperature, cooking timers, basket lifts (if equipped), provides fryer status, operational prompts, and alarm conditions. Stores fifty (50) programmable Menu Item cooking presets, provides cook timer for each basket. Separate display for each Vat.
3.1	Function Keys	Keys activate various Controller functions.
3.2	Controller Keypad	Input menu numbers, time & temp values, start & cancel features, etc. Keys <b>[2]</b> - <b>[4]</b> - <b>[6]</b> - <b>[8]</b> act as arrow keys for various functions.
4 / 8	High-Limit Indicator (Left & Right Vat)	Light is illuminated to indicate shutdown of the heating elements due to excessive heating condition. Should this light turn on during operation, <b>DISCONTINUE COOKING ACTIVITIES</b> and refer to <b>Troubleshooting, Section 7. DO NOT ATTEMPT TO CONTINUE COOKING UNTIL CAUSE OF THE CONDITION IS DETERMINED!</b>
5 / 9	Heat Indicator Light (Left & Right Vat)	Light is illuminated when the Heat Switch is in the <b>[HEAT]</b> position and the heating elements are energized. This light will cycle <b>ON</b> and <b>OFF</b> during normal operation as the Controller maintains the set-point temperature.
6	Power Indicator Light	Light is illuminated whenever the main Power Switch is in the <b>[ON]</b> position.
7	Basket Lift Switch <b>(OPTIONAL)</b>	Enables or disables Basket Lifts. In the <b>[LIFT]</b> position, basket lift lowers when a cook cycle starts and is raised when cook time expires. In the <b>[OFF]</b> position, both lifts are disabled and will not operate. <b>NOTE: Switch is present only if the Basket Lift option is installed, otherwise position is plugged.</b>
11	Upper Display (OLED)	Displays Fryer setting information, alarm error messages, menu item preset settings, and various operational messages and instructional prompts. One display for each Vat.
12	Lower Display (7-Segment)	Main display for actual timer countdown and current actual oil temperature. Also displays various status and/or error codes. One display for each Vat.

3.4. Control Panel (EOF-20 & EOF-24)

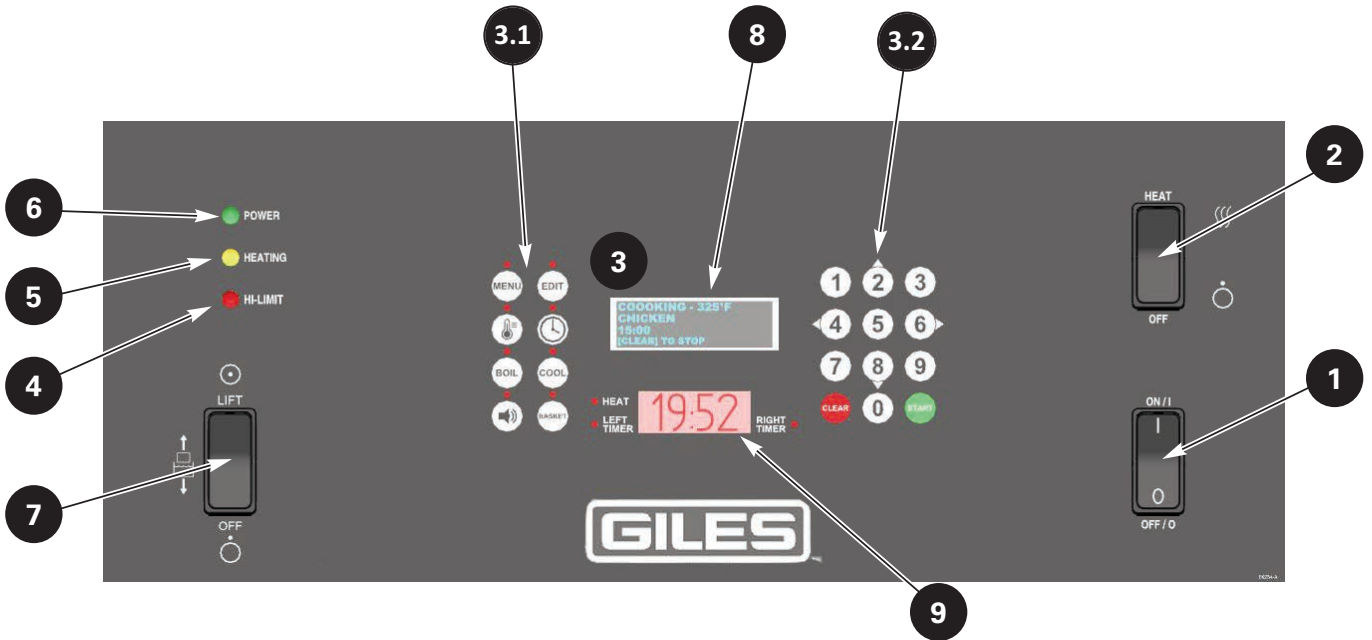

3.4. Control Panel (EOF-20 & EOF-24)		
Item	Description	Function
1	Power Switch	The Power Switch turns Fryer power <b>ON</b> and <b>OFF</b> .
2	Heat Switch	Heat Switch enables the heating elements. Place in <b>[OFF]</b> position to disable heat; when ready to heat oil (or boil-out), place in the <b>[HEAT]</b> position to enable elements . In certain circumstances elements will <b>NOT</b> turn <b>ON</b> even with switch in the <b>[HEAT]</b> position.
3	Controller	Monitors and regulates Fryer operation ... cooking oil temperature, cooking timers, basket lifts (if equipped), provides fryer status, operational prompts, and alarm conditions. Stores fifty (50) programmable Menu Item cooking presets, with cook timer for each basket
3.1	Function Keys	Keys activate various Controller functions.
3.2	Controller Keypad	Input menu numbers, time & temp values, start & cancel features, etc. Keys <b>[2]</b> - <b>[4]</b> - <b>[6]</b> - <b>[8]</b> act as arrow keys for various functions.
4	High-Limit Indicator	Light is illuminated to indicate shutdown of the heating elements due to excessive heating condition. Should this light turn on during operation, <b>DISCONTINUE COOKING ACTIVITIES</b> and refer to Troubleshooting, Section 7. <b>DO NOT ATTEMPT TO CONTINUE COOKING UNTIL THE CAUSE OF THIS CONDITION IS DETERMINED!</b>
5	Heat Indicator Light	Light is illuminated when the Heat Switch is in the <b>HEAT</b> position and the heating elements are energized. This light will cycle <b>ON</b> and <b>OFF</b> during normal operation as the Controller maintains the set-point temperature.
6	Power Indicator Light	Light is illuminated whenever the main Power Switch is in the <b>[ON]</b> position..
7	Basket Lift Switch <b>(OPTIONAL)</b>	Enables or disables Basket Lifts. In the <b>[LIFT]</b> position, basket lift lowers when a cook cycle starts and is raised when cook time expires. In the <b>[OFF]</b> position, both lifts are disabled and will not operate. <b>NOTE: Switch is present only if the Basket Lift option is installed, otherwise position is plugged.</b>
8	Upper Display (OLED)	Displays Fryer setting information, alarm error messages, menu item preset settings, and various operational messages and instructional prompts.
9	Lower Display (7-Segment)	Main display for actual timer countdown and current actual oil temperature. Also displays various status and/or error codes.



3.5. Control Panel (FFLT Dump Station)

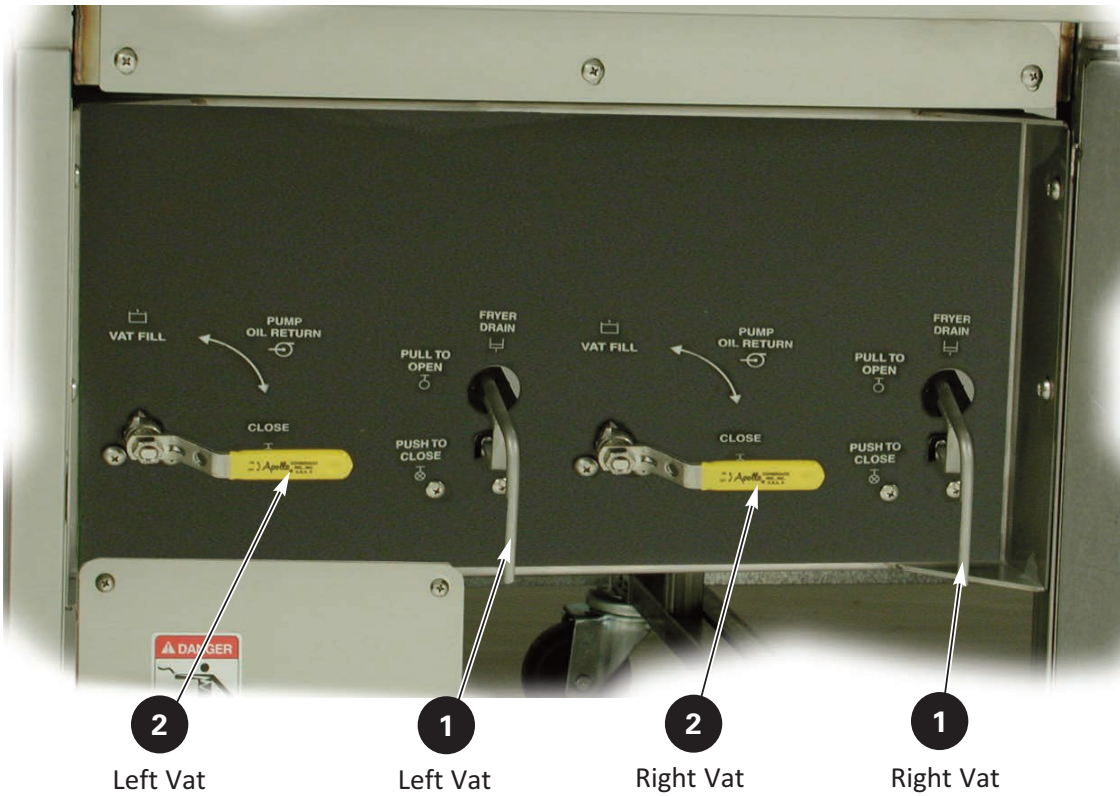

<b>3.5. Control Panel (FFLT Dump Station)</b>		
<b>Item</b>	<b>Description</b>	<b>Function</b>
1	Pump Switch	Turns the Filter Pump <b>ON</b> or <b>OFF</b> to circulate oil through the oil filtration system and return it to a selected Fry Vat, or to pump waste oil from the Filter Pan to an appropriate waste oil disposal container.

3.6. Lower Cabinet (EOF10-10 Split Vat)



3.6. Lower Cabinet (EOF10-10 Split Vat)		
Item	Description	Function
1	Drain Valve Handle	<p>Opens and closes the cook vat Drain Valve. Always be sure the valve is fully <b>CLOSED</b> (tab on handle hooked through panel opening) prior to adding cooking oil, or boil out solution. <b>Fryer will not heat if the Drain Valve is not completely closed!</b></p> <p> <b>DANGER</b> Even though safety interlocks are built in, always be sure the Heat Switch on Control Panel is in the [OFF] position before opening this valve. Failure to do this could result in fire, causing serious injury, even death, damage to equipment or property, and void the warranty.</p> <p> <b>WARNING</b> NEVER drain oil from more than one (1) Fryer at a time into the Filter Pan. Doing so will cause the Filter Pan to <b>OVERFLOW!</b> Always pump oil from Filter Pan back to Fryer vat or to an oil disposal container before draining oil from another vat.</p>
2	Oil Return Valve Handle	<p>When in the [VAT FILL] position, oil is pumped from the Filter Pan back to the Fry Vat, during the filter cycle.</p>

## 3.7. Lower Cabinet (EOF-20 & EOF-24)

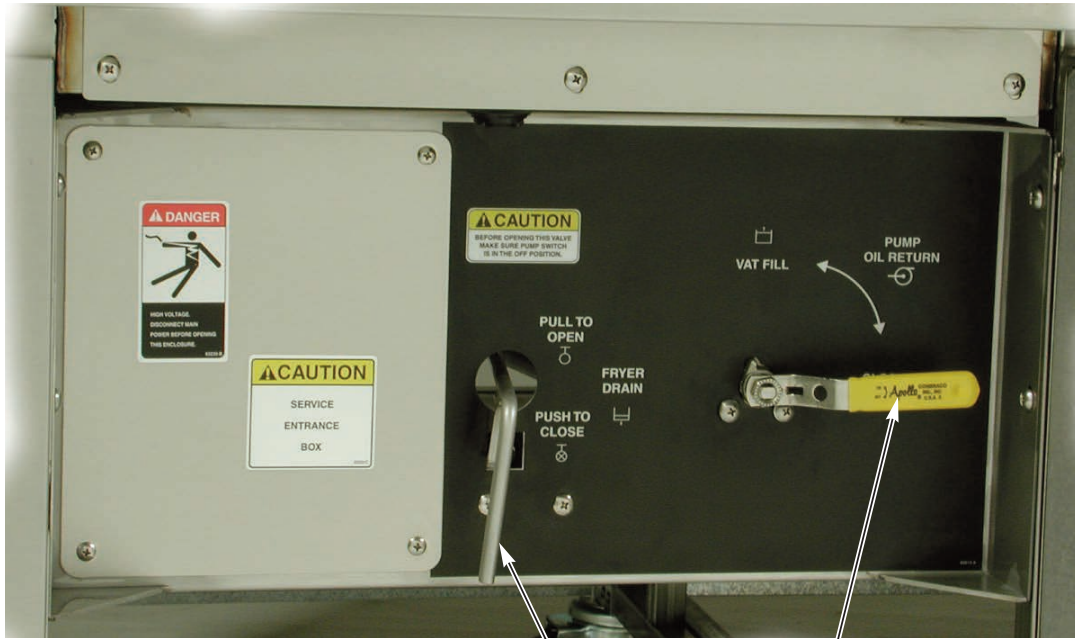

EOF-20

1

2



EOF-24

2

1

3.7. Lower Cabinet (EOF-20 & EOF- 24)		
Item	Description	Function
1	Drain Valve Handle	<p>Opens and closes the cook vat Drain Valve. Always be sure the valve is fully <b>CLOSED</b> (tab on handle hooked through panel opening) prior to adding cooking oil, or boil out solution. <b>The Fryer will not heat if the Drain Valve is not completely closed!</b></p> <p><b>⚠ DANGER</b> Even though safety interlocks are built in, always be sure the Heat Switch on Control Panel is in the [OFF] position before opening this valve. Failure to do this could result in fire, causing serious injury, even death, damage to equipment or property, and void the warranty.</p> <p><b>⚠ WARNING</b> NEVER drain oil from more than one (1) Fryer at a time into the Filter Pan. Doing so will cause the Filter Pan to <b>OVERFLOW!</b> Always pump oil from Filter Pan back to Fryer vat or to an oil disposal container before draining oil from another vat.</p>
2	Oil Return Valve Handle	When in the [VAT FILL], oil is pumped from the Filter Pan back to the Fry Vat, during the filtering process.

3.8. *FFLT Dump Station*



<b>3.8. FFLT Dump Station</b>		
<b>Item</b>	<b>Description</b>	<b>Function</b>
1	Landing Table	Dump area for cooked product. Small drain tube under Screen directs drainage into Filter Pan underneath.
2	Landing Table Ribbed Screen	Allows excess oil to drain from the freshly cooked product.

3.9. FFLT Lower Cabinet (Filter Pan)

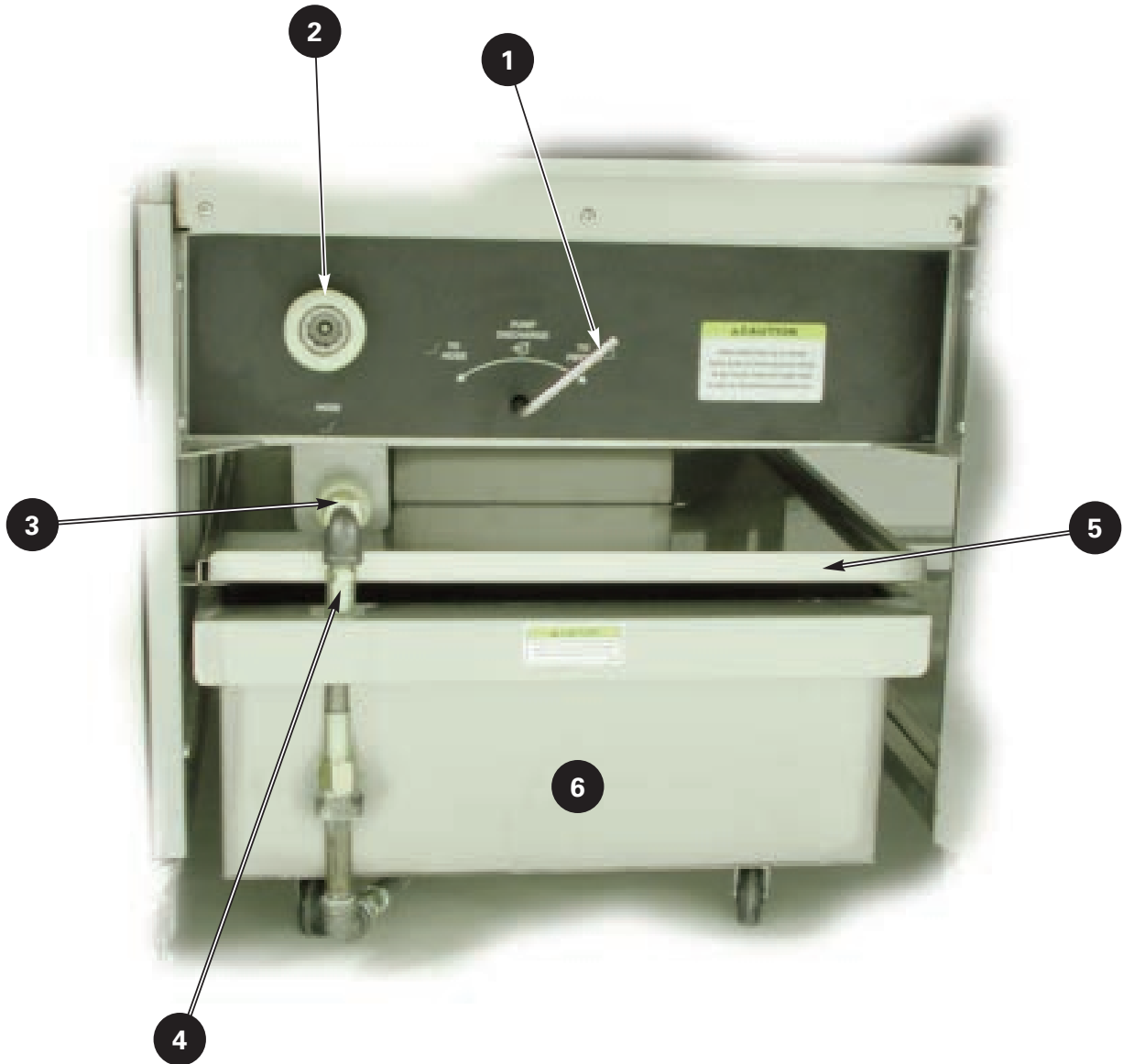

3.9. FFLT Lower Cabinet Area		
Item	Description	Function
1	Diverter Valve Handle	Directs flow from the Filter Pump to either the Fry Vat or the Waste Oil Discharge Hose.
2	Quick-disconnect for Oil Discharge Hose	Connection fitting for the Waste Oil Discharge Hose for removing used cooking oil from a Fryer.
3	Quick-disconnect Fitting for Filter Pan Hose	Fitting for connecting the Filter Pan quick-disconnect hose to the oil filtration system.
4	Filter Pan Hose	Connects Filter Pan assembly to the oil filtration system.
5	Filter Pan Cover	Helps to contain splash and splatter when draining oil into the Filter Pan and prevent possibility of foreign material contaminating oil during filtering cycles.
6	Filter Pan	Collects and contains oil drained from a Fry Vat. Contains filter media for filtering cooking oil at designated intervals. Each vat of the banked unit drains into this single Pan.

**⚠ WARNING**

- Never remove the Filter Pan while it contains liquid shortening. Oil spillage and/or burn injuries are possible. Please see *Section 5.4, Removal of Liquid Shortening*.
- Never drain oil from more than one (1) vat at a time into the Filter Pan. Capacity is designed to contain a volume of oil for only a single vat. Attempting to add more can result in overflow of hot oil and present an injury hazard.

**⚠ CAUTION**

- Always wear thermal protection, such as oven mitts, when handling these parts. They can become very HOT during normal operations!
- Never drain boil-out solution into the Filter Pan. It is corrosive and will damage the Filter Pan and components, and the Filter Pump. See *Section 6.1, Boil-Out Procedure*.

3.10. Filter Pan Assembly Detail







3.10. Filter Pan Assembly		
Item	Description	Function
1	Hold-Down Lever (4)	Secures Hold-Down Frame tightly against the filter media to create a seal with the Pan bottom.
2	Hold-Down Frame	Holds and seals the filter media (paper or screen) against Filter Pan bottom.
3	Filter Paper Media	Filters residue from cooking oil during the filtering process. At least (1) sheet of Filter Paper must be used.
3*	Filter Screen Media <b>(Optional SSFS)</b>	Renewable, stainless steel Filter Screen. Optional substitute for Filter Paper. With proper care, Screen should be usable for several months.
4	Crumb Screen	Provides additional filtering. Captures large crumbs and residue as oil is being drained into Filter Pan.
5	Filter Pan	Collects oil drained from Vat for filtering or disposal. Contains filter media. Casters provide portability, making it easily to remove for cleaning and renewal of filter media. The permanent perforated filter support screen in the Pan bottom supports the filter media and aids in keeping unintended large debris out of the filter system. <b>IMPORTANT! THIS IS NOT A FILTER; FILTER MEDIA (PAPER OR SCREEN) MUST BE USED.</b>
6	Filter Pan Quick-Disconnect	Connects Filter Pan to the Fryer oil filtration system. Hose must be properly and securely connected or pump suction may will be lost.





## WARNING





- Never remove the Filter Pan while it contains liquid shortening. Oil spillage and/or burn injuries are possible. Please see *Section 5.4, Removal of Liquid Shortening*.
- Never drain oil from more than one (1) vat at a time into the Filter Pan. Capacity is designed to contain a volume of oil for only a single vat. Attempting to add more can result in overflow of hot oil and present an injury hazard.

## CAUTION

- Always wear thermal protection, such as oven mitts, when handling these parts. They can become very HOT during normal operations!
- Never drain boil-out solution into the Filter Pan. It is corrosive and will damage the Filter Pan and components, and the Filter Pump. See *Section 6.01, Boil-Out Procedure*.

<b>3.11. Accessories Included with Unit</b>		
<b>Part</b>	<b>Description/Part Number</b>	<b>Function</b>
	Drain Brush P/N: <a href="#">71025</a>	Use for cleaning certain areas of a Fry Vat.
	Drain Brush, Small P/N: <a href="#">73235</a>	Main use is for cleaning the FFLT Dump Station drain tube.
	Stir Paddle P/N: <a href="#">77775</a>	Use to stir cooking oil during preheat, and to separate and stir product being cooked to prevent sticking, and promote even cooking.
	Fry Vat Brush P/N: <a href="#">71100</a>	Use to scrub Fry Vat sides, and heating elements.
	Crumb Shovel P/N: <a href="#">30059</a>	Use to remove filter sediment from the surface of filter media after filtering cooking oil.

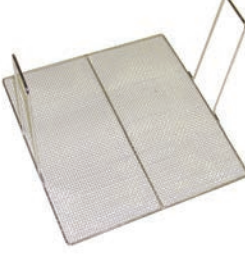

3.11. Accessories Included with Unit - continued		
Part	Description/Part Number	Function
	L- Shaped Brush P/N: 73233	Use to clean between, and underneath heating elements.
	Vat Drain Clean Out Tool P/N: 36577	Use to clear excessive crumb build-up from the vat drain opening.
	Oil Discharge Hose P/N: 33667	Use to remove waste cooking oil from the unit for disposal. <b>IMPORTANT! Not intended for use as a Fry Vat wash-down tool.</b>
	FFLT Drain Screen P/N: 70085	Allows for better draining of excess oil from freshly cooked product.

<b>3.11. Accessories Included with Unit - continued</b>		
Part	Description/Part Number	Function
	<p>(2) EOF-20 Fry Basket (Blue Handle) P/N: <a href="#">70420</a></p>	<p>Contains product when cooking in the EOF10-10 / EOF-20.</p>
	<p>Scoop Basket P/N: <a href="#">70430</a></p>	<p>Use to removing cooked product when batch cooking without using Fry Baskets.</p>
	<p>EOF-20 Crumb Screen P/N: <a href="#">70083</a></p>	<p>Prevents breading crumbs and cooking residue from falling into bottom of vat and accumulating around the heating elements.</p>
	<p>EOF-24 Crumb Screen P/N: <a href="#">70084</a></p>	
	<p>(2) EOF-10-10 Crumb Screen P/N: <a href="#">71110</a></p>	

## 3.12. Accessories Not Included with Unit (Purchased Separately)

Part	Description/Part Number	Function
	Stainless Steel Filter Screen (SSFS) P/N: <a href="#">41017</a>	Renewable, reusable filter media; direct replacement for Filter Paper. Can be cleaned and reused. <b>IMPORTANT! Not to be used with filter paper.</b>
	Filter Paper P/N: <a href="#">60328</a>	Filters cooking oil during filtering process.
	Filter Powder P/N: <a href="#">72004</a>	Filter aid is required for an effective filtering process. Reconditions oil by removing soluble impurities.
	Fryer Boil-Out P/N: <a href="#">72003</a>	Mix with water during the Boil-out procedure to clean Fry Vats.

**3.12. Accessories Not Included with Unit (Purchased Separately) - continued**

Part	Description/Part Number	Function
	<p>EOF-24 Fry Basket P/N: 70421</p>	<p>Contains product when cooking in the a EOF-24 Fryer Unit.</p>
	<p>Fryer Tool Caddy/Splash Guard  P/N 71523  <b>(Tools shown come standard with Fryer; extras can be purchased separately)</b></p>	<p>Dual purpose Fryer attachment (no tools required to install)  Store and organize Fryer Tools right at the fryer.  Also serves as a Splash Guard to keep oil splatter or splash off the floor and/or adjacent equipment.</p>
	<p>Giles Oil Caddy P/N: 79187</p>	<p>A portable waste oil disposal container with manually operated pump. Unit has capacity for 80 lbs of liquid waste oil.  <b>Note: Use only with filtered, warm oil only. Pump cannot handle crumbs and cooking debris.</b></p>

## 4. Installation Check-out & Prep

Giles takes pride in the quality of its workmanship. Each unit passes rigorous quality control inspection and testing prior to shipment, and every effort has been made to ensure that the unit is in perfect operating condition when received. To further ensure a smooth start-up, a brief operational check-out of the new fryer should be conducted as described in this section.

Start-up assistance and basic operational training by a factory-approved service agent can be arranged if desired. Such service is **not included** as part of the Fryer purchase and the cost of such service is the responsibility of the purchaser. Call Giles at 800.554.4537 for more details.

### CAUTION

Before attempting to operate the Unit, please refer to *Section 3* and become familiar with the various controls and their function. After you have read and fully understand *Section 3*, please follow the steps described below ... precisely follow them to avoid possible equipment damage or malfunction.

### 4.1. Set-up for Initial Checkout

Please ensure Control Panel switches and Lower Cabinet valves are set as follows before proceeding to each test. The check-out procedures described in the subsequent Sections should be performed for each unit of the banked unit.

1. Power Switch ① and Heat Switches ② are in the [OFF] position.

**NOTE:** Each Fryer in the bank must be set accordingly.



EOF-20 or EOF-24



EOF10-10

Continued on Next Page

## 4.1. Set-up for Initial Checkout - continued

- 2. Open the FFLT Cabinet Door and remove the Filter Pan.
- 3. Ensure the Drain Valve Handle on each unit is in the [CLOSE] and Locked (3) position (tab through opening & tucked behind panel).
- 4. Ensure the Oil Diverter Valve is in the [TO FRYER] (4) position.
- 5. Remove Crumb Screen(s) and Baskets from all cook Vats.

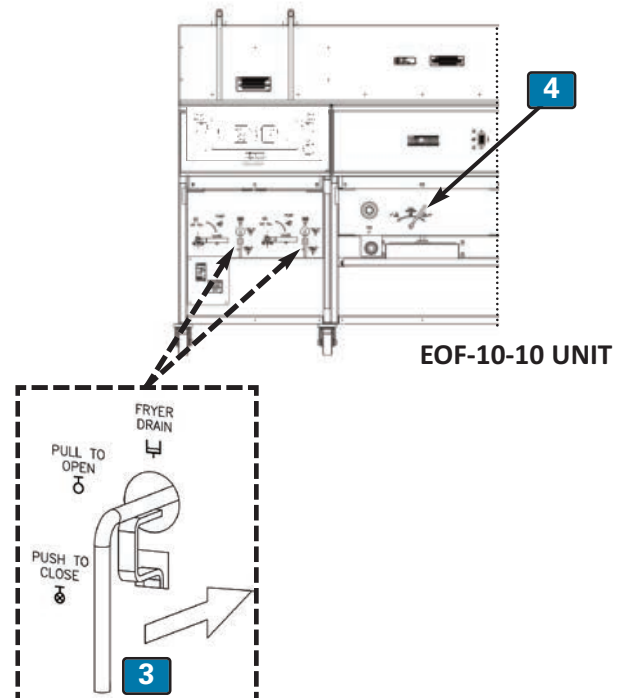
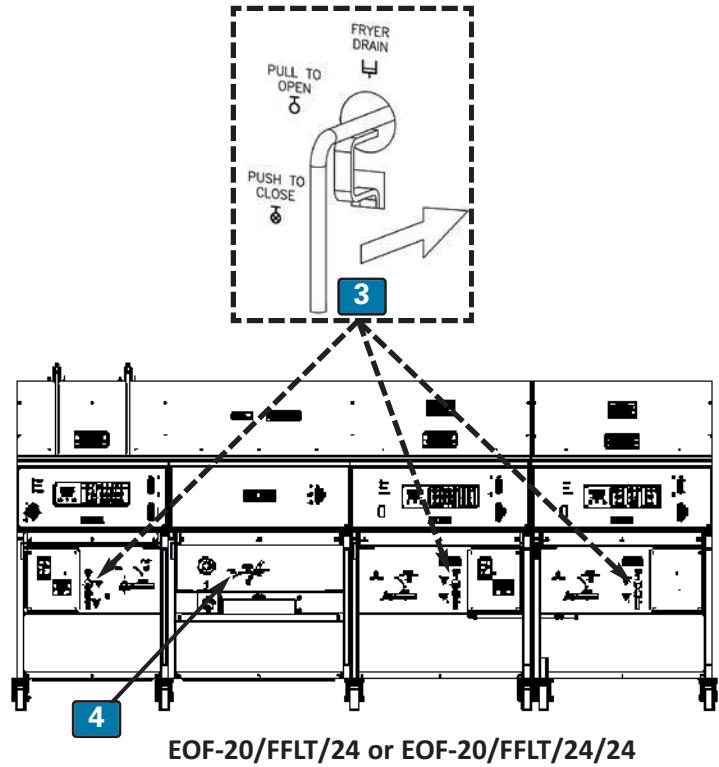

## 4.2. Power Check

The following test will ensure the unit has power. Perform test on each unit in the bank.

1. Set-up as described in **Section 4.1**.
2. Be sure the main circuit breaker supplying power the unit is **ON**. If a Disconnect Switch Box is installed, be sure it is **ON**.
3. Place the Power Switch **①** in the **[ON]** position. If the green POWER light **②** illuminates and the Computer Controller powers-up and sounds an alarm tone after a few seconds, unit is receiving power. Return power switch to **[OFF]** and proceed to **Section 4.3**.

If the POWER light does not come on or the Controller does not power-up, refer to **Section 7.1, Troubleshooting**.



EOF-20 or EOF-24



EOF10-10

## 4.3. Heating Element Test

The following test will ensure the Heating Element is being powered. **Perform this test on each unit.**

⚠ DANGER

The Heating Elements become extremely hot when energized! Any skin contact with them may result in severe burns.

1. Set-up as described in **Section 4.1**.
2. Be sure Power Switch is in the **[OFF]** position.
3. Liberally dampen a sponge with water and wipe down the Heating Element **①**, leaving visible moisture on the surface.
4. Place the Power Switch **②** in the **[ON]** position.
5. **EOF-20 or EOF-24:** Wait for the Controller to power-up, sound the alarm signal and display the message **"POWER FAILURE PRESS [START] TO PREHEAT"** on the **Upper OLED Display** and **[HOLD]** on the **Lower 7-Segment Display** **③**.
6. Press the **[START]** key **④** ... the alarm signal will silence, and the Controller will indicate **PREHEAT**.  
**EOF10-10 Unit Only:** Message **"START WHICH SIDE ... [4]=LEFT, [5]=BOTH, [6]=RIGHT"** is shown on the **Upper OLED Display** ... select **BOTH [5]**; Controller will indicate **PREHEAT**.
7. Set the Heat Switch **⑤** (both on EOF10-10) to the **[HEAT]** position. The **HEAT** light(s) should turn on. Leave switch(es) in the **[HEAT]** position for **NO MORE THAN 10 to 12 SECONDS**.  
**Note:** During this time, should the **HEAT** light turn off, an alarm sound and the **Upper OLED Display** show a **"MAX ELEMENT TEMP"** error; return Power Switch to the **[OFF]** position and proceed on to the next step.
8. Return Heat Switch(es) **⑤** to the **[OFF]** position. Leave Power Switch in the **[ON]** position.
9. The moisture on the heating elements should quickly dry and heat should be felt rising from the Vat. Proceed to **Section 4.4**.  
 If the moisture does not dry within a few seconds, or no heating is detected, refer to **Section 7.1, Troubleshooting**.

**8 EOF-20 or EOF-24**

**EOF-10-10**

40

## 4.4. Filter Pump Test

The following test will ensure the Filter Pump is operating correctly.

1. Set-up as described in **Section 4.1**.
2. Open Landing Table (FFLT) Cabinet Door. Remove the Filter Pan if in place.
3. Be sure that the Power Switch of the left-hand unit is still in the **[ON]** position.
4. Place the palm of your hand over the Filter Pan quick-disconnect fitting **①**.
5. Place the Pump Switch **②** in the **[ON]** position and allow it to briefly run, then return switch to **[OFF]**. If suction is felt at the fitting, the pump is operating correctly. Return Power Switch to **[OFF]** and proceed to **Section 4.5**.

If no suction is detected, or if air seems to be blowing outward, refer to **Section 7.2, Troubleshooting**.

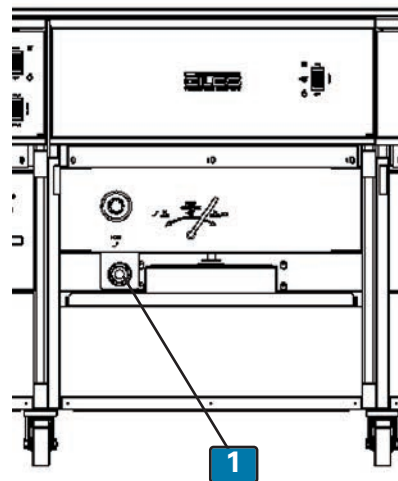

### IMPORTANT!

Should any of the previously described check-out tests fail to produce acceptable results and Troubleshooting Procedures explained in **Section 7** cannot correct the situation, please contact **GILES Technical Support** at **800.554.4537**. It may be necessary to have a factory-authorized service company dispatched to evaluate and/or repair the unit. New Giles equipment is warranted against defects in material or workmanship for a period of twenty-four (24) months from date of installation. **This Limited Warranty applies for the original owner only.**

## 4.5. *Perform Boil Out Procedure*

Perform a Boil Out Procedure on each cook vat to remove dirt and debris that may have accumulated during shipping, and to remove any residue from manufacturing processes. See **Section 6.1, Boil Out Procedure**. After boil-out is complete, proceed to see **Section 4.6, Initial Cleaning**.

## 4.6. *Initial Cleaning*

- Disassemble and thoroughly clean the Filter Pan to remove dirt and debris that may have accumulated during shipping, and to remove any oils or residue that may remain from manufacturing processes. See **Section 6.2, Cleaning Filter Pan & Replacing Filter Paper after Boil-Out**.

**NOTE:** It is normal for surface rust to possibly form on the Hold-down Frame and steel Support Frame in the Filter Pan during warehousing and shipment. Typically, this type of rust can be easily removed with a wire brush or steel wool. Once unit is in service, it is unlikely that rust will form again.

- Wash all accessory items (Screens, Baskets, Basket Scoop, Brushes, tools, etc.) in warm soapy water and dry thoroughly.
- Remove any adhesive protective film that may remain on sheet metal surfaces. This has been left on the unit to help protect the exterior finish during shipment. Clean exterior surfaces with a good quality stainless steel cleaner/polish.

**Fryer preparation is now complete; proceed to the Fryer Operation Section.**

## 5. Fryer Operation

**EOF Series Fryers** are high capacity electric open Fryers, banked together into a single unit that features a built-in Dump Station for receiving the product after cooking and a single oil filtration system. The fryer bank is available with several different optional configurations: **Model EOF20/FFLT/24, EOF20/FFLT/24/24, EOF10-10/FFLT/24 & EOF10-10/FFLT/24/24**. EOF20 is a 20" square vat unit; EOF24 is a 24" square vat unit; EOF10-10 is single fryer unit with a split-vat design featuring two 10" x 20" cook vats, each independently controlled by a single Controller.

### DANGER

- Turn off the Fryer power switch and main supply power at the main electrical panel before cleaning or performing maintenance.
- **DO NOT** wash down the Fryer interior or exterior with water from a spray hose, or any other pressure-type washing equipment.
- Failure to comply with **DANGER** notices will result in serious injury, even death, damage to equipment or property and void the factory warranty

### WARNING

- **DO NOT** use or store flammable liquids, or materials that produce flammable vapors, in the vicinity of this or any other appliance!
- **DO NOT (or ALLOW OTHERS) for any reason, stand or step onto the top of the appliance.** Cooking oil in Fryers can be **EXTREMELY HOT (excess of 330°F [166°C])**. Bodily contact will cause extremely serious injury. Lids used to sometimes cover cooking vats/pots are not designed to, and **WILL NOT**,  support the weight of a person.
- Failure to comply with **WARNING** notices could result in serious injury, even death; damage to equipment and/or property and will void the factory warranty.

### CAUTION

- Be sure the Fryer is positioned in a stable, safe location with the casters in the locked position.
- Consult an electrician to be certain that all electrical specifications have been met and the unit is properly grounded. A wiring diagram is provided with the unit to aid an electrician.
- Due to the high temperature of cooking oil in the Fryer during cooking, it is extremely important that the user exercise due caution in operating this equipment to avoid personal injury. It is recommended that thermal protective gear, such as mitts or gloves, be worn to prevent burn injuries.
- This appliance is not intended for use by persons (including children) with reduced physical, sensory, or mental capabilities, or lack of experience and knowledge, unless they have been given adequate instruction and/or supervision concerning its use by a person responsible for their safety. Children should be supervised, or otherwise restricted, to ensure they do not play with or around this appliance.

## 5.1. Computer Controller

The following sections explain the functions, features, programming, and operational procedures for the two different Computer Cooking Controllers used on EOF Series Fryers ... Single/Dual Timer & Dual Display.

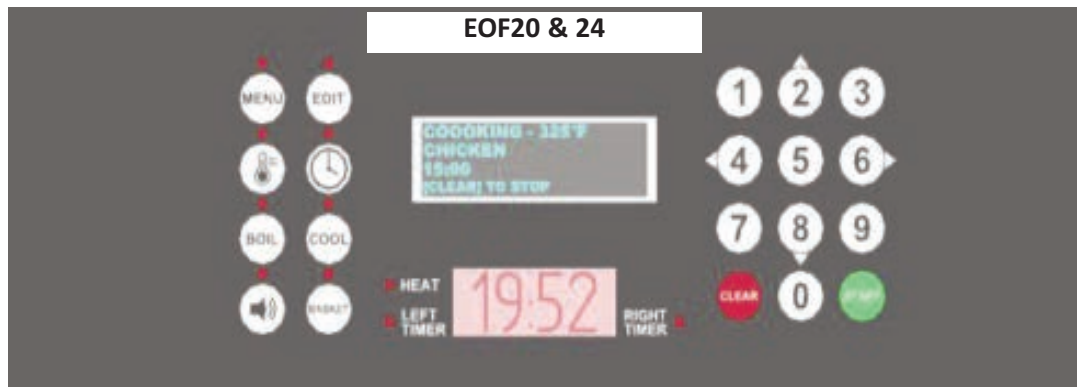

### 5.1.1. Keys and Functions



**Numeric Keypad:** Used for entering Fryer settings and to edit preset Menu Item cooking parameters. The [2-4-6-8] keys are also used as **[ARROW KEYS]** for operating Basket Lifts (if installed), selecting timer, navigating lists, moving cursor for editing, etc. [2-8] = UP/DOWN ... [4-6] = LEFT/RIGHT. The keys will illuminate to indicate when they are active as **ARROW KEYS**.

**[START]:** Function key used to start cook cycles, select items, save settings, and exit editing, etc.

**[CLEAR]:** Function key used to cancel cook cycles, exit certain functions, etc.

## 5.1.1. Keys and Functions - continued



**MENU Key:** Action key which is pressed in combination with other keys to access programmed menu presets. Fifty (50) different Menu Item cooking presets can be programmed.



**EDIT Key:** Action key which is pressed in combination with other keys to enter edit mode to change or create Menu Item preset settings.



**TEMP Key:** Press this key to set the cooking oil temperature setpoint. Pressing this key twice (2x) will display **ACTUAL OIL TEMPERATURE** on the **Lower Display** for approximately 20 seconds.



**CLOCK Key:** Press this key to begin manually setting a cooking time (mm:ss).



Press this key during preheat to enter the **BOIL OUT** mode. Temperature setpoint and time changes to the **BOIL TEMP** and **BOIL OUT TIME** as specified in **USER SETTINGS** (see *Section 5.1.7, Access & Edit User Settings*). **Default = 200°F & 30 minutes.**



Press this key to enter **COOL** mode, which allows the Fryer to idle at a lower temperature during inactive periods to save energy. Temperature setpoint changes to the **COOL TEMP** specified in **USER SETTINGS** (see *Section 5-01.7, Access & Edit User Settings*) ... **default setting = 275°F.**



**ALARM Reset Key:** Pressing this key silences the Controller alarm and acknowledges certain status messages.



**BASKET Key:** Activates the **UP/DOWN [2 - 8]** keys to manually operate Fryer Basket Lifts. Key is disabled during **PREHEAT** phase to prevent lowering product into oil that is not yet at cooking temperature. **This key is ONLY active if Basket Lifts are installed.**



**Upper OLED Display:** Displays menu preset information, Fryer status information, and operational prompts and instructions.



**Lower 7-Segment Display:** Displays various status information, cook cycle time countdown, temperature, etc.



**Indicators:** **[HEAT]** illuminates to indicate that Controller is calling for heating elements to energize. **[LEFT/RIGHT Timer]** illuminates to indicate which Timer is active.

## 5.1.2. Controller - General Operation

The following is general operational information only. Detailed procedures and instructions are covered in subsequent sections. During operation, certain instructions and prompts will be shown on the **Upper OLED Display** to step Users through processes. Some Controller keys and indicator lights will illuminate to further guide the User.

- **POWER UP:**  
Place **Power Switch** in [ON] position. Controller will power up, then an alarm sounds. The message **“POWER FAILURE [PRESS START TO PREHEAT]”** is shown on the **Upper Display**. **This is normal**, intended to prevent Fryer from beginning to heat after power interruptions until attended by an operator. Pressing the [START] key silences the alarm and places Fryer into **PREHEAT** mode. If the **Heat Switch** is in the [HEAT] position, and temperature setpoint is higher than the current actual oil temperature, heating elements will turn **ON** and cooking oil will begin to heat.
- **PREHEAT:**  
During the **PREHEAT** phase, the real-time actual oil temperature is displayed on the **Lower 7-Segment Display**. When oil reaches the programmed setpoint, an alarm tone sounds, the **Upper OLED Display** will display message **“ALARM, STIR OIL”**. Vigorously stir the cooking oil, and press [ALARM] key. Typically, oil temperature will drop when stirred. Controller has a 10 second delay and if oil temperature drops below setpoint, **PREHEAT** continues until oil returns to setpoint. **This process helps ensure that temperature is more uniform throughout the total volume of oil, leading to better cooking performance.** Upon reaching setpoint, the alarm sounds again and the **Upper Display** reads **“ALARM - SETPOINT REACHED”**. Pressing the [ALARM] key, places the Fryer in **READY** state.
- **READY STATE:**  
Fryer is ready for cooking. The current cooking temperature setpoint will be shown on the **Lower Display** and the last used cooking parameters (preset or input information) are shown on the **Upper Display**.

While in **PREHEAT** or **READY** state, User can select (or change) a Menu Item Preset, see **Section 5.1.4.1, Selecting a Menu Preset -OR-** User can manually set a different cooking time and/or oil temperature, see **Section 5.1.3, Set a Manual Temperature & Cook Time.**

**NOTE: If the PASSCODE ENABLE is set to ON, User cannot manually set Time without first entering the proper password. This lockout feature provides a measure of control over cooking procedures.**

- **START:**  
Current cook settings will be shown on the **Upper OLED Display** for each Basket or Vat (dual display). To start the cooking timer:
  - (a). EOF20/24, press the [START] key + select BASKET side: [4] = Left, [6] = Right, [5] = Both
  - (b). EOF10-10, press the [START] key + [4] for LEFT VAT or [6] for RIGHT VAT.

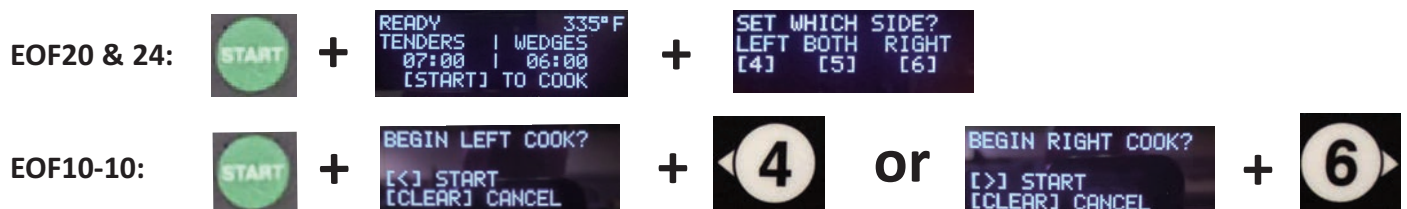

## 5.1.3. Setting the Cooking Temperature

Cooking temperature setpoint is input as shown below. **Menu Item presets in the Controller do not contain cooking temperature settings.**

Instructions are shown on the **Upper OLED Display** to help guide User through the process.

### SINGLE DISPLAY CONTROLLER - EOF20 & EOF24 FRYER UNITS:

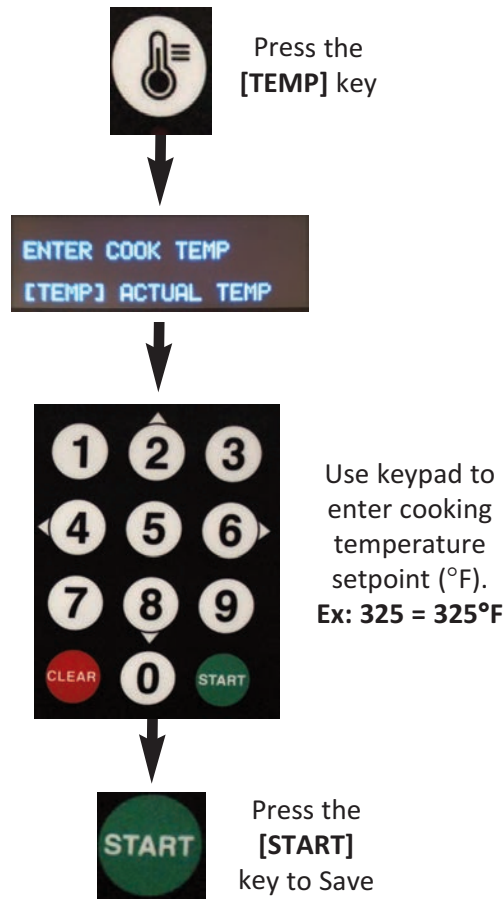

- If actual oil temperature is lower than the entered setpoint temperature when [START] is pressed, the Controller enters **PREHEAT** mode (red **HEAT** indicator beside **Lower 7-Segment Display** turns **ON**), but before oil will actually begin heating, the **Heat Switch must be placed in the [HEAT] position**; the amber **HEAT** indicator on the Fryer Control panel will turn **ON** to indicate heating elements are energized.
- If the oil temperature is already equal to or greater than the entered setpoint, an alarm sounds and the message **SETPOINT REACHED** is displayed. Press the **[ALARM]** key and the Controller will enter **READY** state. Fryer is ready for cooking.

While heating, the real-time actual oil temperature will show on the **7-Segment Display**. After setpoint is reached, the display shows the temperature setpoint.

**NOTE:**

Pressing the [TEMP] key twice (2x) will display the actual oil temperature for 20 seconds.  
Cook Temperature default unit is °F ... can be changed in **USER SETTINGS**, see **Section 5.1.8**.

## 5.1.3. Setting the Cooking Temperature - continued

### DUAL DISPLAY CONTROLLER - EOF10-10 FRYER UNITS:

Each side of the EOF10-10 Fryer unit is a separate cook vat capable of maintaining different cooking temperatures. **Menu Item Presets** stored in the Dual Display Controller include temperature settings, as well as names and cooking times. Rather than selecting one of the presets, temperature may also be manually set, as described below.

Information will be shown on the **Upper OLED Display** to help guide Users through the process. **NOTE: The left-hand display is always active when entering settings.**

**IMPORTANT!**  
If **PASSCODE** feature is enabled, cooking temp **cannot** be manually input without the required password. Without password, Users can only choose from the programmed **Menu Presets**, see **Section 5.1.5, Working with Menus**.

**NOTE:**  
Pressing the **[TEMP]** key twice (2X) will display actual oil temperature of each Vat side for 20 seconds on the respective **Lower 7-Segment Display**.  
  
Cook Temperature default unit is **°F** ... can be changed in **USER SETTINGS**, see **Section 5.1.8**.

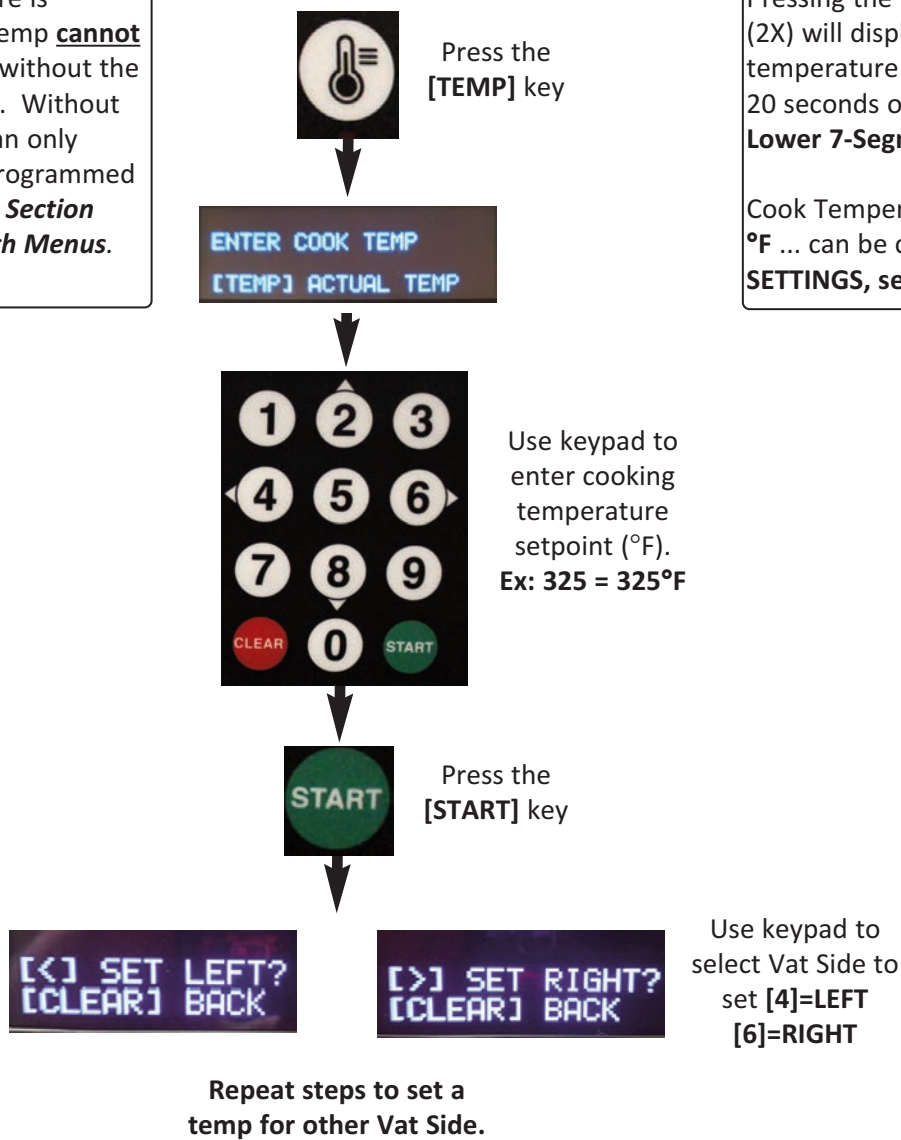

**NOTE:** Menu Presets contain an Item Name which is normally displayed on the **Upper OLED Display**. When a cooking temp is manually input, the Name displayed changes to **[MANUAL]**.



## 5.1.4. Manually Setting the Cooking Time

The following describes the procedure for manually inputting a cooking time, rather than selecting a Menu Preset.

### IMPORTANT!

If **PASSCODE** feature is enabled, cooking time **cannot** be manually input without the required password. Without password, User can only choose a programmed **Menu Presets**, see **Section 5.1.5, Working with Menus**.

### SINGLE DISPLAY CONTROLLER - EOF20 & EOF24 FRYER UNITS:

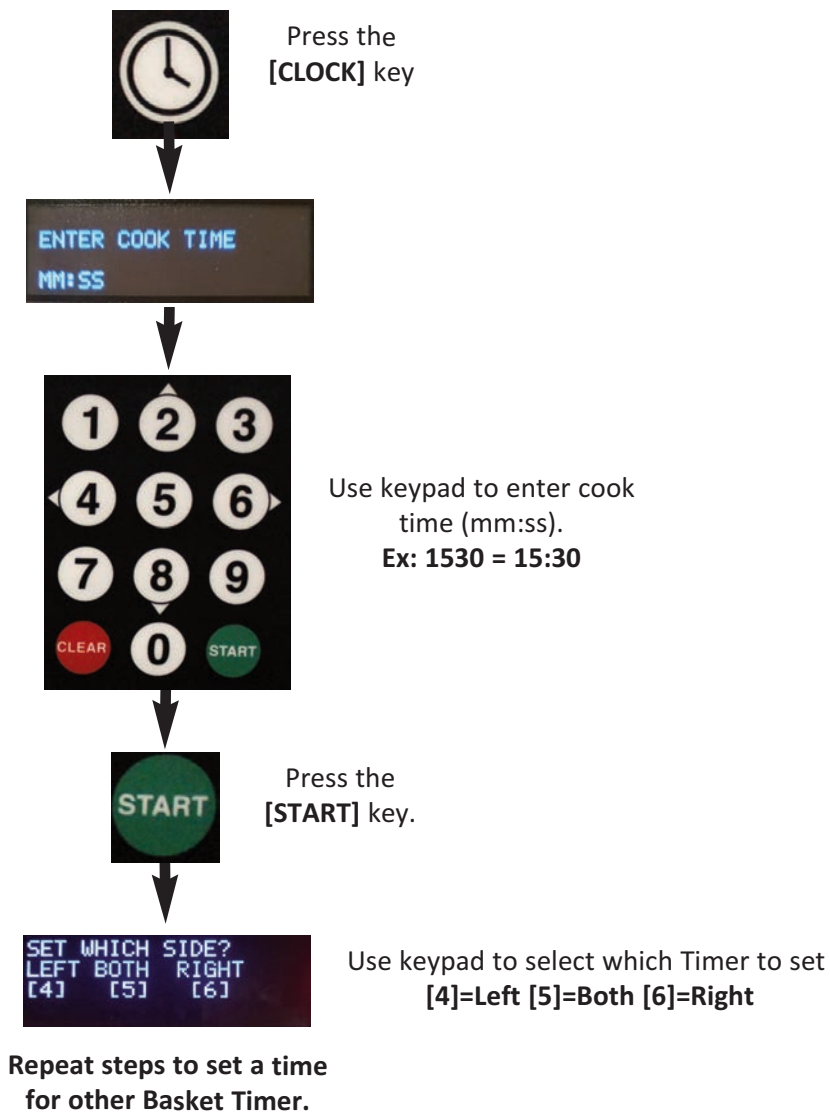

**NOTE:** Menu Presets contain an Item Name which is normally displayed on the **Upper OLED Display**. When a cooking time is manually input, the Name displayed changes to **[MANUAL]**.



Continued on Next Page

## 5.1.4. Manually Setting the Cooking Time - continued

### DUAL DISPLAY CONTROLLER - EOF10-10 FRYER UNITS:

The following procedure manually inputs a cooking time, rather than selecting a Menu Preset. Information is shown on the **Upper OLED Display** to help guide Users through the process. **NOTE: Left-hand Display is always active when entering settings.**

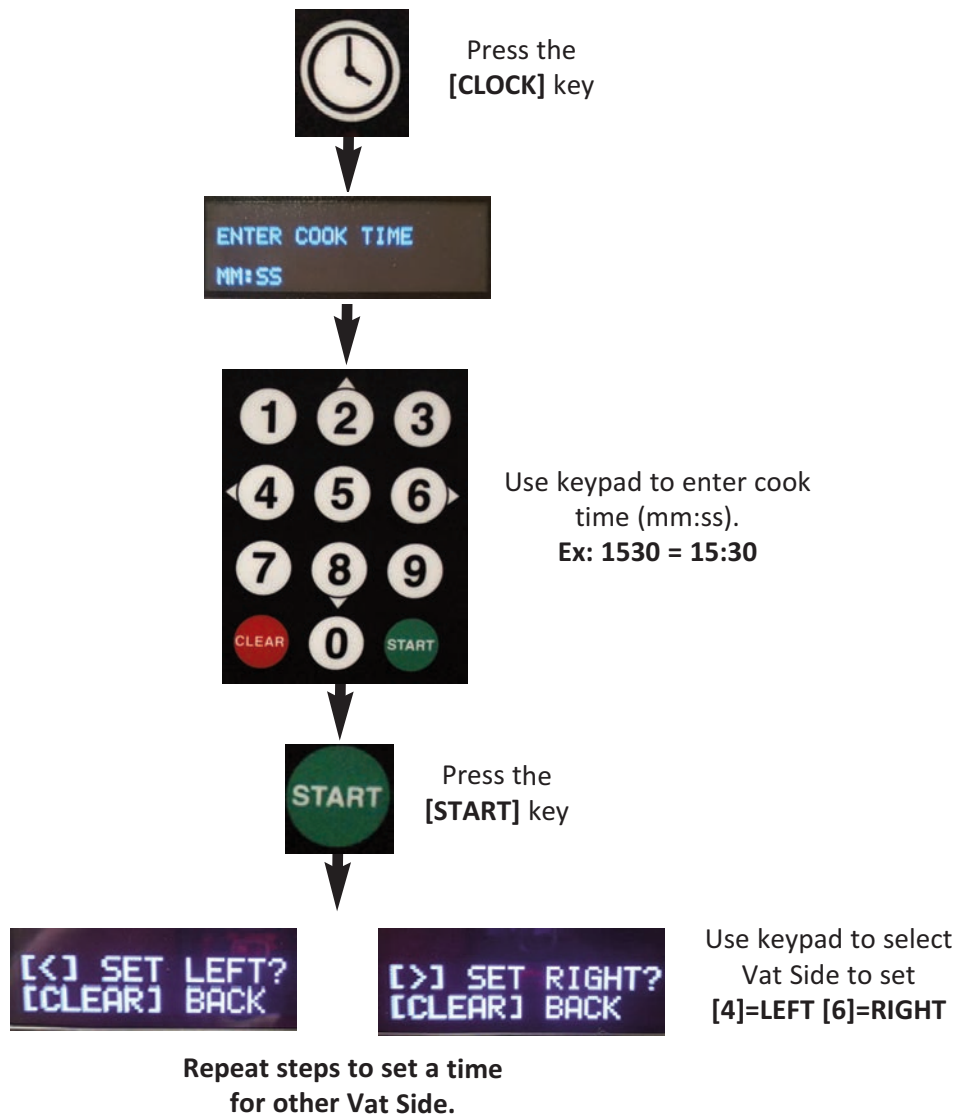

**NOTE:** Menu Presets contain an Item Name which is normally displayed on the **Upper OLED Display**. When a cooking time is manually input, the Name displayed changes to [MANUAL].



## 5.1.5. Working with Menus

**NOTE:**

Menu Item Presets stored in the Single Display Controller (EOF20/24) **do not** include Cooking Temperature settings. Cooking temp must always be input manually, see **Section 5.1.3, Setting the Cooking Temperature.**

Fifty (50) **Menu Item Preset** cook settings are stored in the Controller, each includes:

- **Menu #** - Sequential ID number
- **Menu Name** - Name of the food product assigned to the preset.
- **Cooking Time** - Cook time setting for the specific menu item.
- **Cooking Temperature (EOF10-10 Unit ONLY)** - Cooking oil temperature setting for the specific menu item. Temperature setpoint is automatically changed to this setting when the Preset is selected for cooking.
- **STIR OVERRIDE** - Users may wish to override the Controller global **STIR ALARM** setting in **USER SETTINGS** for certain menu items. **Factory default = [NORMAL], use global setting.**
- **FISH FILTER** - To prevent flavor transfer, establishments cooking seafood products may wish to force an oil filtering after only **one (1) batch** of a particular seafood item is cooked. The setting overrides the global **FORCE FILTER** setting in **USER SETTINGS**. **Factory default = [OFF], use global setting.** Also, a **SNOOZE** feature can be selected which will allow **two (2) batches** of the product to be cooked before filtering is forced.

All 50 **Menu Presets** are factory-programmed with default settings. The first ten (10) are set to specific menu names and settings for some popular menu offerings (Table below). All others contain the general settings shown on the last line of the table. Users can edit any settings as needed to customize for specific applications and menus.

Details for working with Menu Item Presets are covered in the following sections.

MENU NO.	MENU NAME	*TEMP (F°)	TIME (MM:SS)	STIR OVERRIDE	FISH FILTER
1	BONE-IN-CHICKEN	335°	13:00	NORMAL	OFF
2	TENDERS	335°	7:00	NORMAL	OFF
3	WEDGES	335°	6:00	NORMAL	OFF
4	BONE-IN-WINGS	335°	8:00	NORMAL	OFF
5	BONELESS WINGS	335°	7:00	NORMAL	OFF
6	POPCORN CHICKEN	335°	3:00	NORMAL	OFF
7	LIVERS	335°	4:00	NORMAL	OFF
8	CORNDOGS	335°	10:00	NORMAL	OFF
9	CHEESE STICKS	335°	3:00	NORMAL	OFF
10	FISH	335°	3:00	NORMAL	OFF
<b>11 thru 50</b>	<b>MENU XX</b>	<b>335°</b>	<b>2:00</b>	<b>NORMAL</b>	<b>OFF</b>

**\* TEMP applies ONLY to EOF10-10 Unit w/Dual Display Controller**

## 5.1.5.1. Editing a Menu Preset

**NOTE:** Left-hand side on Dual Display Controller is active when editing Menu Items.

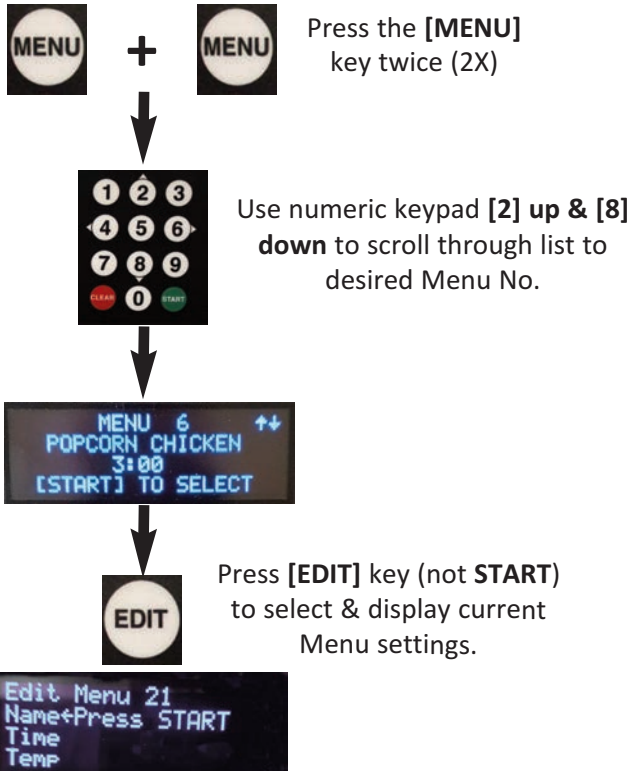

Use numeric keypad [2]-up & [8]-down to select what to edit

- [NAME]
- [TIME]
- \* [TEMP]
- [STIR]
- [FISH FLTR]

"<-Press START" points to setting to be edited.

\* [TEMP] is NOT available for edit on the EOF20/24 Controller



Two different methods may be used to edit NAME, see instructions (A) & (B) on the right.

### A. Edit [NAME] - Method 1: Enter NAME letter by letter.

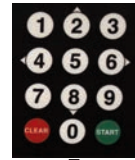

Select edit **NAME** as shown on left. Flashing cursor is positioned at 1st letter. Use keypad [2]-up or [8]-down to scroll letters, character changes at cursor position while scrolling. Stop at desired character, then use [4]-left or [6]-right to move cursor to next character; repeat to spell **NAME**.

When finished editing **NAME**, press [START] to **Save** -OR- press [CLEAR] to **Cancel and Exit** without saving



### B. Edit [NAME] - Method 2: Select NAME from Catalog of programmed names.

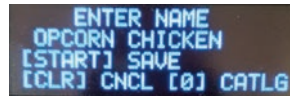

Select edit **NAME** as shown on left. Flashing cursor is positioned at 1st letter. Press [0] key to open Catalog of programmed names and use keypad [2]-up or [8]-down to scroll through list. Press [START] to copy **NAME** into the Menu Item being edited and return to previous display.



If done, press [START] to **Save** -OR- press [CLEAR] to **Cancel and Exit** without saving -OR- [0] to re-open catalog.



Pressing [CLEAR] 2X will **Exit** from **Editing**.

Continued on Next Page

## 5.1.5.1. Editing a Menu Preset - continued

C. Edit COOKING TIME: Scroll to and select [TIME] as explained on Page 52.

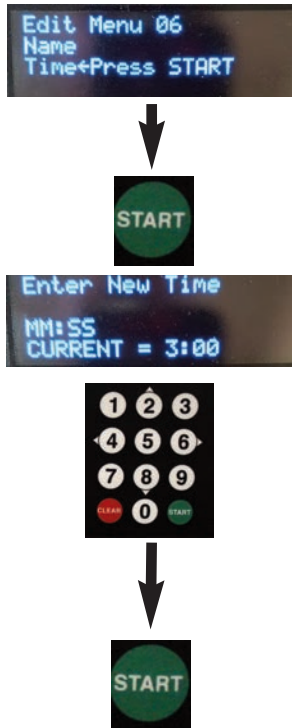

Current time setting will be displayed.  
 Use numeric keypad to enter a new **TIME** (mm:ss)  
**NOTE: All digits must be entered, ex: 500 = 5:00.**  
 When entering, [CLEAR] key backspaces to delete an incorrect input, allowing correction.

After entering new **TIME** value press  
**[START]** to Save  
 -OR-  
 press **CLEAR** to exit without Saving



Pressing [CLEAR] 2X will Exit  
 from Editing.

D. Edit SETPOINT TEMPERATURE (ONLY applies to EOF10-10 UNIT): Scroll to and select [TEMP] as shown on Page 52.

**NOT** a preset Menu Item setting on EOF-20/24 Units ... **TEMP** must be input manually.  
 See Section 5.1.4, *Manually Setting the Cooking Temperature* (Single Display Controller)

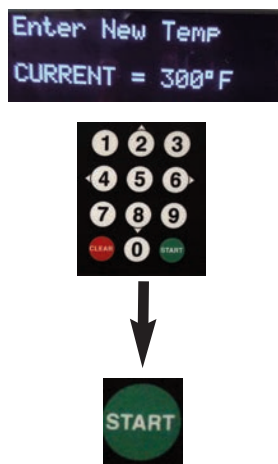

Current temperature setting will be displayed.  
 Use numeric keypad to enter a new **TEMP** (°F)  
 Ex: 325 = 325°F  
 When entering, [CLEAR] key backspaces to delete an incorrect input, allowing correction.  
**NOTE: TEMP** unit can be changed to (°C) in **USER SETTINGS**, see Section 5.1.8

After entering new **TEMP** value press  
**[START]** to Save  
 -OR-  
 press **CLEAR** to exit without Saving



Pressing [CLEAR] 2X will Exit  
 from Editing.

## 5.1.5.1. Editing a Menu Preset - continued

### E. Edit STIR OVERRIDE Setting:

Certain food products may, or may not, require stirring during the cook cycle, regardless of how the global **STIR ALARM** setting in **USER SETTINGS (Section 5.1.8)** is specified. **STIR OVERRIDE** is provided so that the global setting can be overridden, as needed, for particular menu items. Options are **[SKIP]**, **[FORCE]**, or **[NORMAL]**. When set to **[SKIP]** or **[FORCE]** the stir alarm will either be skipped or forced **ON**, regardless of the global setting. When set to **[NORMAL]**, the stir alarm will follow the global setting ... **Factory-default = [NORMAL]**

To edit **STIR OVERRIDE** setting, scroll to and select **[STIR]** as shown on **Page 52 ... [>]** pointing to **[STIR]**

Pressing the **[START]** key toggles between the available options.



---

### D. Edit FISH FILTER Setting:

To minimize potential for flavor transfer, establishments cooking seafood items may wish to force operators to filter oil after only **one (1) batch** of a seafood item is cooked. When **FISH FILTER** is set to **[ON]**, the unit will enter **FILTER MODE** after completing **one (1)** cook cycle of the specific menu item. If **FORCE FILTER SNOOZE** is set to **[ON]** in **USER SETTINGS (Section 5.1.8)**, operator is allowed to cook one (1) additional batch of a seafood item before being forced to filter oil. If **FORCE FILTER=[OFF]** in **USER SETTINGS** a filter warning message is displayed on the Controller; if **FORCE FILTER=[ON]**, the fryer is locked out until the filter cycle is completed.

To edit **FISH FILTER** setting, scroll to and select **[FISH FLTR]** as shown on **Page 52 ... [>]** pointing to **[FISH FLTR]**

Pressing the **[START]** key toggles between the available options.

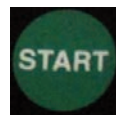

When finished with editing a Menu Item Preset, press the **[CLEAR]** key. Settings for the edited preset are displayed for confirmation. If correct, press **[CLEAR]** key again to return to the **READY** display.

To edit another Menu Item, press the **[EDIT]** key once again; scroll through list with arrow keys **[2]** and **[8]** to find Item to be edited.

## 5.1.5.2. Selecting a Menu Preset for Cooking

**Direct Entry:** The two (2) methods described below can be used when a desired Menu No. is known.

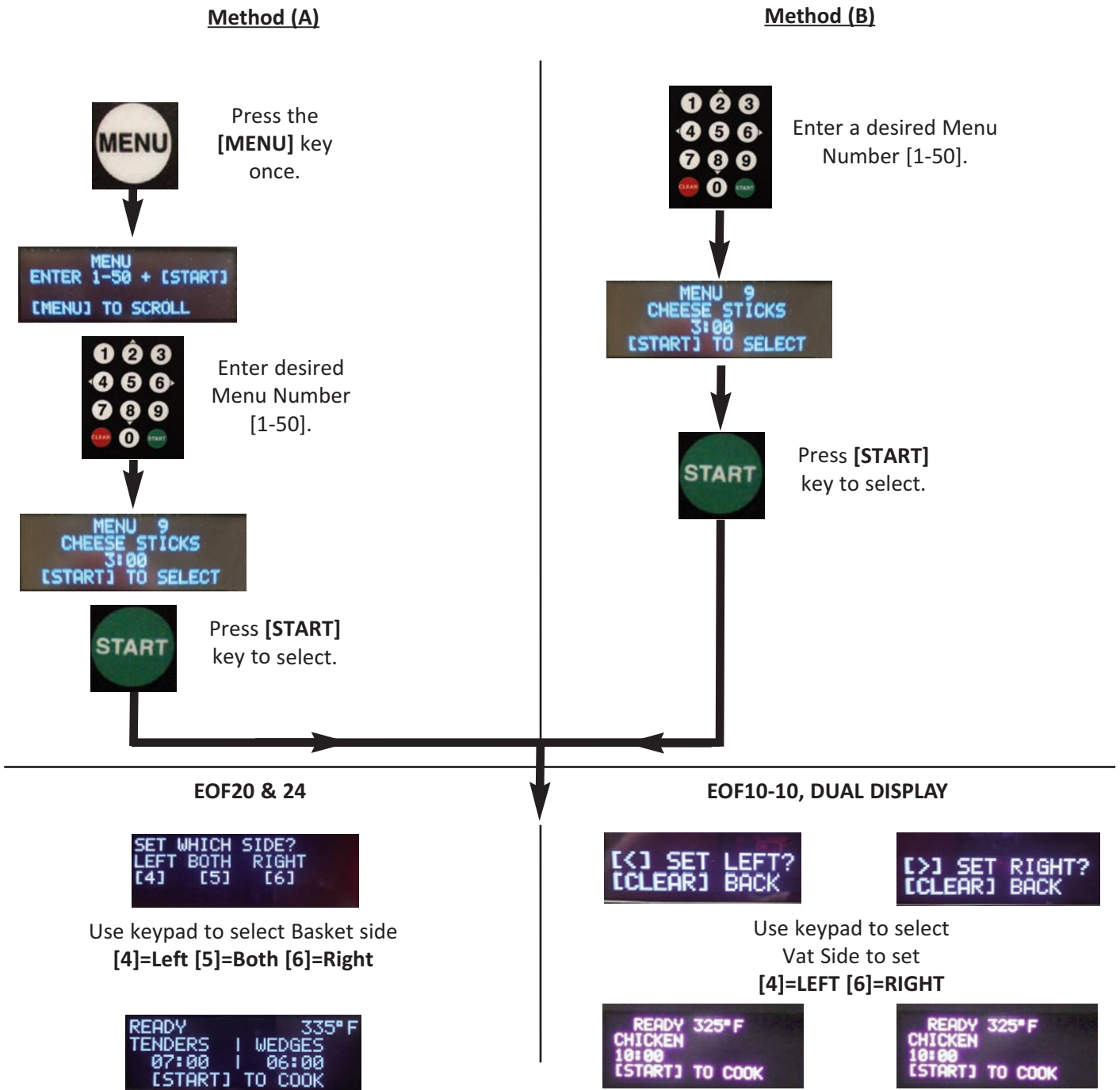

If the Fryer is in the **READY** state, the cooking cycle can be started; see *Section 5.1.6, Cooking Cycle, General Overview*.

## 5.1.5.2. Selecting a Menu Preset for Cooking

**Scroll Method:** If the Menu No. is not known, User can scroll through list of **Menu Item Presets** to select the desired item ... settings for each preset will appear on the **Upper Display**.

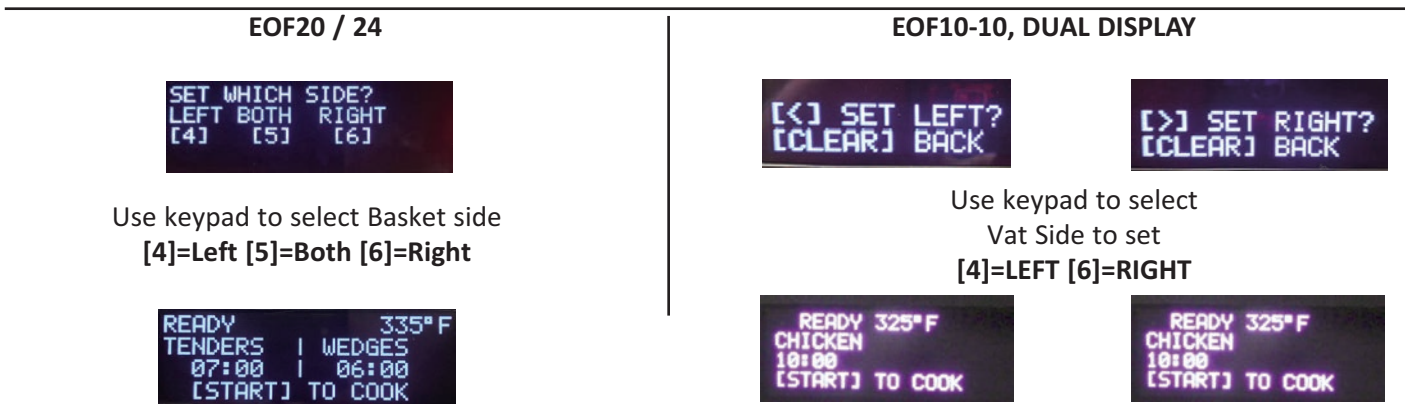
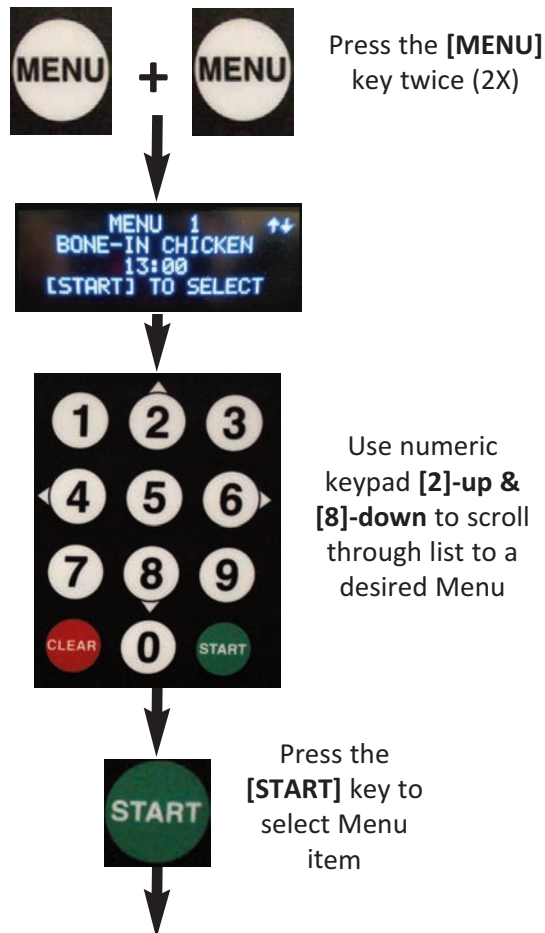

If the Fryer is in the **READY** state, the cooking cycle can be started; see *Section 5.1.6, Cooking Cycle, General Overview*.

## 5.1.6. Cooking Cycle - General Overview

EOF-20 / 24, SINGLE DISPLAY:



Active cooking settings [**NAME, TEMP, COOK TIME**], either Presets or manual entry, for each Basket side are shown on the **Upper OLED Display**.



When in **READY** state the **TEMP** setpoint is shown on **Lower 7-Segment Display**. The **READY** message indicates that the Fryer is at the set temperature and ready for cooking.

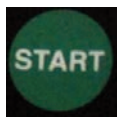

Pressing the [**START**] key once begins the sequence.

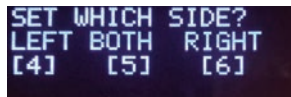

User is prompted to select which Basket side to start. Using numeric keypad, select **LEFT - BOTH - RIGHT**.

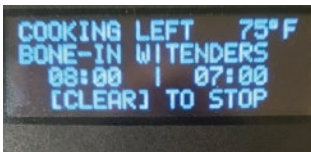

After selecting the Basket side, Controller enters **COOK** state. If Fryer is equipped with automatic Basket Lifts, the Basket will be lowered into the cooking oil and programmed cooking time will begin counting down on the **Lower 7-Segment Display**. The **Upper OLED Display** shows which side's cycle is cooking, as well as displaying the temperature setpoint. If both side are cooking, the display indicates "**COOKING BOTH**". The **Timer Indicator** for the timer being displayed will be illuminated.

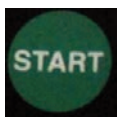

A different cook cycle can be started for the other Basket if desired. To start the cook cycle press the [**START**] key once.



User prompt to select the available Basket side. Press the appropriate arrow key [**4**]-left or [**6**]-right to start the other Timer. **Lower 7-Segment Display** and the **Timer Indicator** will change to reflect the timer just started.



x 2

When both Timers are cooking and counting down, pressing the [**TIME**] key twice will swap the **7-Segment Display** and **Timer Indicator** to reflect the active timer.

## 5.1.6. Cooking Cycle - General Overview - continued

EOF10-10, DUAL DISPLAY:



Active cooking settings **[NAME, TEMP, COOK TIME]**, either Presets or manual entry, are shown on the **Upper OLED Display** of each vat.



When in **READY** state the temperature setpoint is shown on **Lower 7-Segment Display** of each Vat. The **READY** message indicates that the cooking oil is at proper temperature and the Vat is ready for cooking.



Pressing the **[START]** key once begins the sequence.

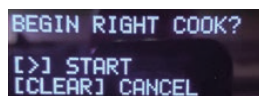

**Upper Display** for each side displays prompt for side to start. Using numeric keypad, select **LEFT [4]** or **RIGHT [6]**.

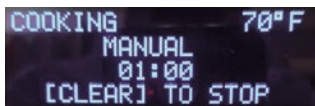

After selecting Vat, the Controller enters **COOK** state. If the Fryer is equipped with automatic Basket Lifts, the Basket will be lowered into the cooking oil and the programmed cooking time will begin counting down on the **Lower 7-Segment Display** of that Vat. The **Upper OLED Display** shows that the Vat is **COOKING**, as well as displaying the programmed setpoint temperature. The **Vat Timer Indicator** is illuminated.

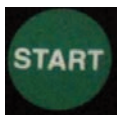

The other Vat Timer can be started if desired. To start the cook cycle press the **{START}** key once.



Prompt is displayed on the idle side display to select the other Vat. Pressing the appropriate arrow key **[4]** or **[6]** will start Timer. **7-Segment Display** of that Vat begins countdown.

## 5.1.6. Cooking Cycle - General Overview - continued

**STIR ALARM:** Sounds an audible alarm at a specific time during the cook cycle, signaling operator it is time to stir the cooking product to help promote even cooking and prevent sticking. The feature must be enabled in **USER SETTINGS, Section 5.1.8** and the point in the cycle when alarm is to sound [**STIR ALARM %**] must be set ... e.g. If [**STIR ALARM %**] is set at **60**, during a 10 minute cook cycle, the alarm will sound after **6 mins.** have elapsed. **Factory-set default = ENABLED w/ [STIR ALARM %] = 62.** If [**STIR OVERRIDE**] is set to [**FORCE**] or [**SKIP**] for the Menu Item cooking, **STIR ALARM** will act accordingly regardless of **USER SETTING**.

On **EOF-20 / 24** Fryer unit, a message prompt indicates which basket side to stir (**LEFT - RIGHT - BOTH**).

When the cooking cycle time is complete, an alarm will sound; if Fryer is equipped with Basket Lifts, the cook Basket is automatically raised from the oil. **EOF-20/24 Single Display** unit ... message **"DONE COOKING - LEFT, RIGHT or BOTH"** is displayed. **EOF10-10 Dual Display** unit ... message **"DONE COOKING"** is shown on the appropriate vat's display. Pressing [**ALARM**] key silences the alarm and the Fryer re-enters **READY** state, ready to cook the next load of product.

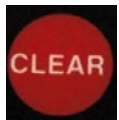

x 2

To cancel a running cook cycle press the [**CLEAR**] key once, then press it again to cancel **-OR-** press [**4**] to continue cooking.

## 5.1.7 Other Controller Features

### 5.1.7.1 Manually Operating the Basket Lifts (If Equipped)

#### EOF20/24, SINGLE DISPLAY

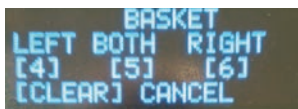
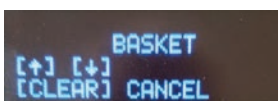

Press the **BASKET** Key once

Use keypad [**2**]-up & [**8**]-down keys to Raise or Lower Basket Lift  
Press [**CLEAR**] to Cancel the operation.



#### EOF10-10, DUAL DISPLAY

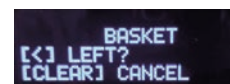
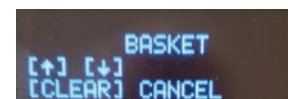

Use keypad to select side  
**EOF20/24**  
[**4**]=LEFT [**5**]=BOTH [**6**]=RIGHT

**EOF10-10**  
[**4**]=LEFT [**6**]=RIGHT

#### NOTE:

- **Lift Switch on Control Panel must be in the [ON] position.**
- Manual Basket Lift operation is disabled while the Controller is in **PREHEAT** state as a safeguard against attempting to cook product in oil that is not yet at the proper cooking temperature.
- Once activated, Basket Lift cannot be actuated again for approximately 20 seconds.

## 5.1.7.2 COOL Mode

**CCOOL Mode** is an energy-saving feature that changes oil temperature setpoint to a lower value. Use to put Fryer into an idle (standby state) during downtime periods. **COOL** mode temperature is significantly lower than cooking temp, but not so low that recovery will require too much time.

To enter **COOL Mode**, press the **[COOL]** key. The temperature setpoint will be changed to the **COOL TEMP** setting specified in **USER SETTINGS**, see *Section 5.1.8, Edit User Settings*. **Factory-set default = 275°F**. Setting can be edited by User in the range of **200°F to 350°F**.

### EOF20/24, SINGLE DISPLAY:



Press **[COOL]** key once.

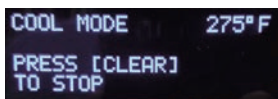

Display changes to indicate **COOL Mode** is in effect.

### EOF10-10, DUAL DISPLAY:



Press **[COOL]** key once. Each Vat side can be placed into **COOL Mode** separately.

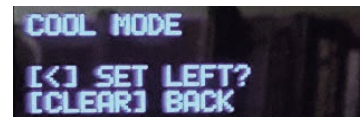

Use keypad to select Vat side  
**[4]=LEFT [6]=RIGHT**

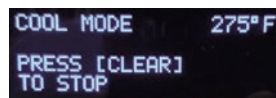

The display of the selected Vat changes to indicate **COOL Mode** is in effect.



- **To exit COOL Mode:** press the **[CLEAR]** key once, then press **[4]** key to stop **COOL Mode -OR-** press **[CLEAR]** key again to continue **COOL Mode**.
- Upon exit, the temperature setpoint returns to the previous active value and Fryer enter **PREHEAT** until temperature is reached.

## 5.1.7.3 AUTO-COOL Feature

When the **AUTO-COOL** feature is turned **[ON]**, the Fryer automatically enters **COOL Mode** after no cook cycles are started within the amount of time specified by the **AUTOCOOL TIME** setting in **USER SETTINGS**, see **Section 5.1.8, Edit User Settings**. **Factory-default = [OFF] ... AUTOCOOL TIME = 30**. Setting can be enabled/edited by User in the range of **1 to 510 mins**.

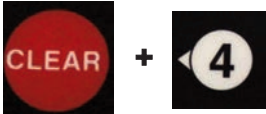

Exit **AUTO-COOL** same as **COOL** ... press the **[CLEAR]** key, then press **[<4]** to exit **COOL** - OR - press **[CLEAR]** again to continue **COOL Mode**.

Upon exit, the temperature setpoint will return to the previous active value and Fryer will enter **PREHEAT** mode until temperature is reached.

## 5.1.7.4 BOIL OUT Mode

**BOIL OUT Mode** is a pre-programmed cleaning cycle for the cooking Vat that can be started by simply pressing the **[BOIL]** key while the Controller is in **PREHEAT** state. Temperature and time settings change to the **[BOIL TEMP]** and **[BOIL OUT TIME]** specified in **USER SETTINGS**, see **Section 5.1.8**. **Factory-setting: [BOIL TEMP] = 200°F ... [BOIL OUT TIME] = 30 minutes**. Settings can be edited by the User within the ranges of **[BOIL TEMP] = 185° to 208°F ... [BOIL OUT TIME] = 1 to 45 minutes**.



Fryer must be in **PREHEAT** to enter **BOIL OUT Mode** ... Press **[BOIL]** key once.

- Temperature setting changes to **200°F**.
- Time setting changes to **30 minutes** and begins to countdown.
- **EOF10-10**: Both Vat sides will enter **BOIL OUT** at the same time.

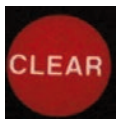

- **To exit BOIL OUT Mode:** press the **[CLEAR]** key once, then ...  
**EOF20/24:** press **[4]** key to **STOP** the **BOIL OUT** cycle.  
**EOF10-10:** press **[4]** key to **STOP** left side ... **[6]** key to **STOP** right side.  
 -OR- press **[CLEAR]** again to continue **BOIL OUT Mode**.

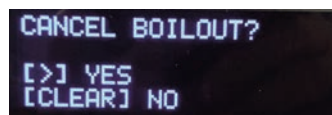
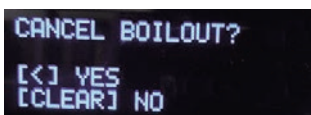

**IMPORTANT!** Fryer must be properly drained, rinsed and prepared for cooking after a Boil Out cycle. See **Section 6, Cleaning**.

## 5.1.8. User Settings - Accessing & Editing



Press the **TIME** key

+ 9999 +



Press the **START** key

Use numeric keypad [4] - [6] (left/right) to scroll through list until desired Setting is shown on the **Upper OLED Display**.



To edit the setting press the [EDIT] key. Use numeric keypad [2] - [8] (up/down) to change the value. Press [EDIT] again to save the new value.



To exit the **USER SETTINGS** menu, press the [CLEAR] key.

**NOTE:**

The message **TOO LOW** or **TOO HIGH** will be displayed if a value being entered is outside the allowable range and would cause a Controller error for the current state of the Fryer.

NAME	DESCRIPTION	RANGE	DEFAULT
TEMP SCALE	Temperature scale	°F or °C	°F
FORCE FILTER	When <b>ON</b> , forces user to filter oil after the specified number of cook cycles are complete ... locks-out Fryer.	ON - OFF	ON
FORCE FILTER SNOOZE	Allows (1) more cook cycle after FORCE FILTER count exceeded when FORCE FILTER = ON.	ON -OFF	OFF
FILTER COUNT	Number of cook cycles before user is required to filter.	1 to 20	4
GUARD BAND	Cooking not allowed if oil temperature is outside of the setpoint by amount of guard band	1 to 990	900
MAX SETPOINT	Maximum oil setpoint allowed.	32°F to 350°F	350°
AUTOCOOL	After a specified amount of time, unit will go into COOL mode.	ON - OFF	OFF
AUTOCOOL TIME (MINUTES)	If <b>AUTOCOOL</b> is <b>ON</b> , then after fryer is idle for the amount of time specified here, the unit will go into <b>COOL</b> mode.	1 to 510 minutes	30
AUDIBLE ALARM (SECONDS)	Duration of the audible alarm in seconds.	5 to 120 seconds	10
COOL TEMP	Temperature of the <b>COOL</b> mode	200°F to 350°F	275°F
BOIL TEMP	Temperature of the <b>BOIL OUT</b> mode	185°F to 208°F	200°F
FILTER RESET	Temperature that allows exiting of filter mode	200°F to 325°F	290°F
BOIL OUT TIME	Time (in minutes) for <b>BOIL OUT</b> mode	1 to 45 minutes	30
STIR ALARM ENABLE	If enabled, allows the stir alarm to come on during a cook cycle.	ON - OFF	ON
STIR ALARM %	When <b>STIR ALARM</b> is <b>ON</b> , the alarm will sound after this % of the cooking cycle is complete.	10% to 90%	62%
KEY BEEP ENABLE	If enabled, audible sound generated with each key press.	ON - OFF	OFF
LANGUAGE	Sets the Controller language	English-Spanish-French	English

## 5.1.9 PASSWORD Protection

It is possible to add **PASSWORD** protection for certain Controller functions and settings. This feature is a **FACTORY SETTING** that is typically **DISABLED**. If **PASSCODE ENABLE** is set to **[ON]**, User is prompted to enter a password before adding or editing **Menu Item Presets**, entering or changing a manual cook time setting, or accessing the **User Settings Menu**.

If you desire to have Password protection enabled, or have questions concerning this feature, call **Giles Technical Services at 800.554.4537** to request the passcode and instructions as to how to enable this feature.

## 5.1.10. Power Up Procedure

- Initially, ensure that **Heat Switch ①** is in the **[OFF]** position.
- Place **Power Switch ②** in the **[ON]** position. The green **Power Light ③** will illuminate; Computer Cooking Controller will power-up, perform memory check and then an audible alarm sounds. The message **“POWER FAILURE [PRESS START TO PREHEAT]”** is shown on the **Upper OLED Display ④**. This is normal, intended to prevent the Fryer from beginning to heat after a power interruption without being attended by an operator. Pressing the **[START] key ⑤** silences the alarm and puts the Fryer into the **PREHEAT** state. The cook settings shown on the **Upper OLED Display** will be the last used. The Controller will indicate that Fryer is heating, but until the **Heat Switch ①** is placed in the **[HEAT]** position, the heating elements will not be energized. **DO NOT** place **Heat Switch** in the **[HEAT]** position until the fry vat has been filled with cooking oil.
- See **Section 5.2, Cooking Procedures**.

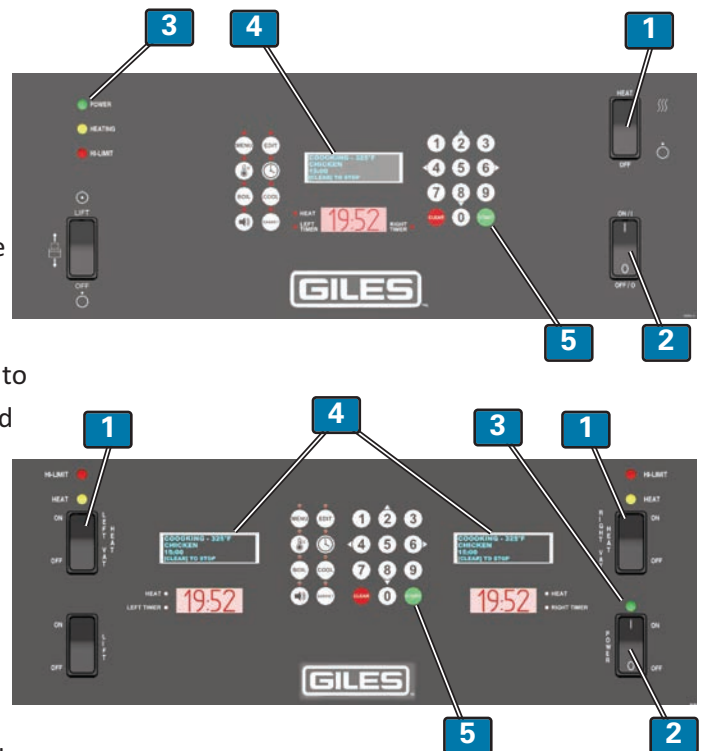

## 5.1.11 Controller Errors & Alarms

Certain conditions, which can cause unsafe operation or damage to the unit, such as open valves, low oil level, high temp, malfunction, etc. will activate error codes and sound an alarm tone. Error Codes will show on the **Lower 7-Segment Display**; error information is shown on the **Upper OLED Display**. Typically, heating elements are disabled until error conditions are corrected. Pressing the **[ALARM]** key silences the alarm tone, but does not clear the error. Error Codes are shown on the following Table; details are presented in the following section.

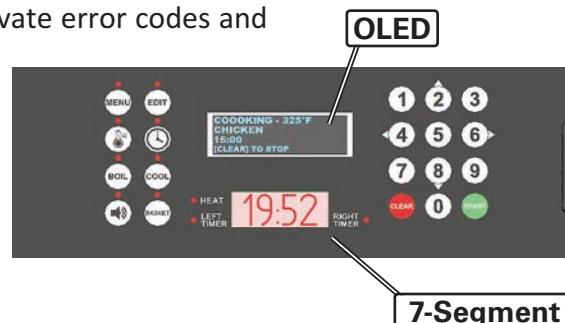

ERROR CODE	DESCRIPTION (OLED Display)	PROBLEM
OPEN	DRAIN IS OPEN	Drain valve is open, or not completely closed. Basket will be raised if it is down. Close drain to clear error.
----	CHECK OIL LEVEL, ENSURE VAT IS FULL, IF FULL THEN PRESS [START]	This is a secondary error displayed after closing drain clears the OPEN error; allows confirmation of oil level.
ER07	MAX ELEMENT TEMP – PRESS [START] (Post Warning)	Error is displayed after MAX element temperature (ER19) has occurred and the element has cooled below MAX temperature, .
ER13	OIL PROBE Error	Problem with the Variable Oil Temp Probe. <b>Service technician required.</b>
ER15	ELEMENT PROBE Error	Problem with the Element Temp Probe, typically attached directly to heating element. <b>Service technician required.</b>
ER19	MAX ELEMENT TEMP Error	The maximum heating element temperature has been exceeded. This is a safety device; <b>NEVER bypass this Probe.</b>
ER21	BAFFLE FILTER MISSING	<b>Not Applicable</b>
ER22	CHARCOAL FILTER MISSING	<b>Not Applicable</b>
ER23	FILTER CLOGGED	<b>Not Applicable</b>
ER24	EAC CELL DIRTY	<b>Not Applicable</b>
ER25	GUARD BAND EXCEEDED	Actual oil temperature deviates from setpoint by the Guard Band amount. Allow oil to cool, or heat, to within range. Factory default is 900°F ... <b>Error should not occur.</b>
ER37	EEPROM Error	An error occurred while saving settings to the EEPROM. <b>Contact Giles Tech Service (800.554.4537).</b>
ER38	Internal ADC Error	The ADC (Analog-to-Digital Converter) chip that reads output from thermocouples is not working. MCB1 board must be replaced. <b>Contact Giles Tech Service (800.554.4537).</b>

## 5.1.11.1 Resolving Controller Errors and Alarms

- **DRAIN OPEN (Error Code OPEN)** - If the pot Drain Valve is open (even slightly) while Fryer power is **ON**, an alarm tone sounds, 7-Segment Display shows **OPEn**, and the OLED Display reads “**ERROR ALARM - DRAIN IS OPEN**”. If the Basket Lift is down, it will be raised. Heating Elements are disabled as long as the condition exists.  
  
Press the **[ALARM]** key to silence alarm tone. Completely close the Drain Valve to clear the error. When error is cleared, alarm tone sounds again and the OLED Display reads “**CHECK OIL LEVEL, ENSURE VAT IS FULL, IF FULL THEN PRESS [START]**”. This is a post-error alarm to alert user to confirm that cooking oil in the pot is still at the **FULL** level. Add oil if needed, then press the **[START]** key to return to **PREHEAT** mode.
- **MAX. ELEMENT TEMP (Error Code 19)** - Heating Element has exceeded the maximum temperature allowed by the Controller. The alarm tone sounds, 7-Segment Display shows **Er19**, and the OLED Display shows “**ERROR ALARM - MAX ELEMENT TEMPERATURE**”. Heating Element is automatically turned **OFF**. It must cool to an acceptable temperature to clear the error. Typical cause of this error is low oil level, which has exposed the heating element. It is possible for a false alarm to occur when preheating cold oil at the initial startup of a new day. Vigorously stirring oil during preheat will usually prevent, or clear, a false alarm of this type.
- **MAX ELEMENT TEMP Post-error Warning (Error Code 07)** - After **Error 19** is cleared, a warning alarm occurs. The 7-Segment Display shows **Er07**, and the OLED Display reads “**MAX ELEMENT TEMP - PRESS [START]**”. This alarm alerts user that a maximum element temperature error occurred and is now cleared. Press **[START]** key to enter **PREHEAT** mode. Heating Element will not turn **ON** until **[START]** is pressed.
- **BAFFLE FILTER MISSING (Error Code 21 - N/A)**
- **CHARCOAL FILTER MISSING (Error Code 22 - N/A)**
- **CLOGGED FILTER (Error Code 23 - N/A)**
- **E.A.C. DIRTY (Error Code 24 - N/A)**

**NOTE: If an error condition cannot be resolved, please contact a factory-authorized service agent, or call 800.554.4537 for Giles Technical Support.**

## 5.2. Cooking Procedure

This section describes procedures for cooking product on **EOF Series Fryers**. Procedures presented assume beginning with a clean empty Fryer.

1. Set cooking oil temperature to a desired setpoint; see **Section 5.1.3, Manually Setting the Cooking Temperature**, or select from Menu Item presets; see **Section 5.1.5.2, Selecting a Menu Preset for Cooking**.

**For an EOF20 / 24 Fryer unit, the cooking temp must be manually set.**

2. Ensure that the Power Switch **①** is in the **[OFF]** position.
3. Ensure that the Heat Switch(es) **②** are in the **[OFF]** position.

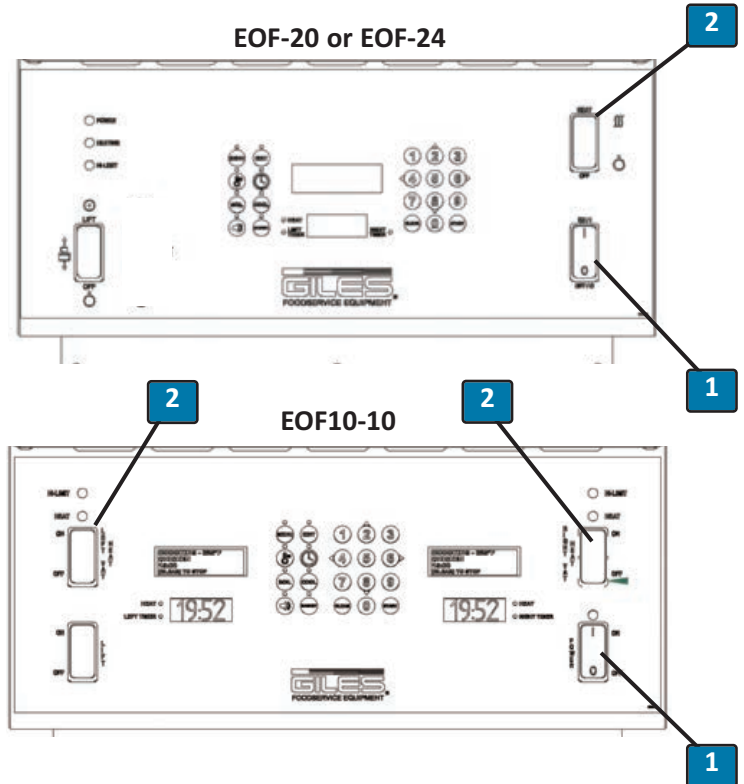

4. Be sure Drain Valve Handle **③** is pushed in and locked in the **[CLOSE]** position (**tab on Handle is through panel opening and tucked securely behind**).
5. Fill the Vat with liquid frying shortening. Fill only to the **ADD** mark **④** at this time to allow for expansion as oil is heated to cooking temperature.

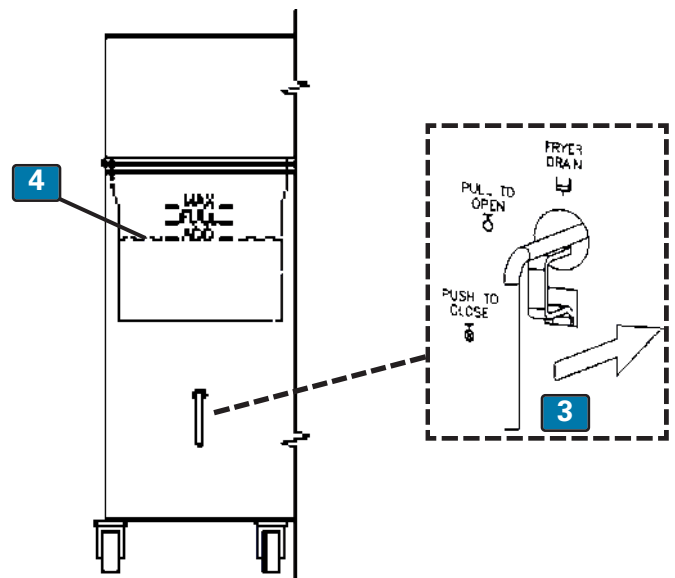

Continued on Next Page

## 5.2. Cooking Procedure - continued

- Set the Power Switch (1) to the [ON] position. The Power Light (5) will turn ON. If the Fryer unit is equipped with Basket Lifts, and if User wants to enable them, place the Basket Lift Switch (6) in the [LIFT] position. **If Lifts are not installed, there is no Lift Switch on the Panel.**

**NOTE:**

If an alarm sounds when Power Switch is placed in the [ON] position and Upper OLED Display (8) shows the message "ERROR ALARM DRAIN IS OPEN", verify that the Drain Valve is tightly closed, press the [ALARM] key (10) and follow Controller prompts.

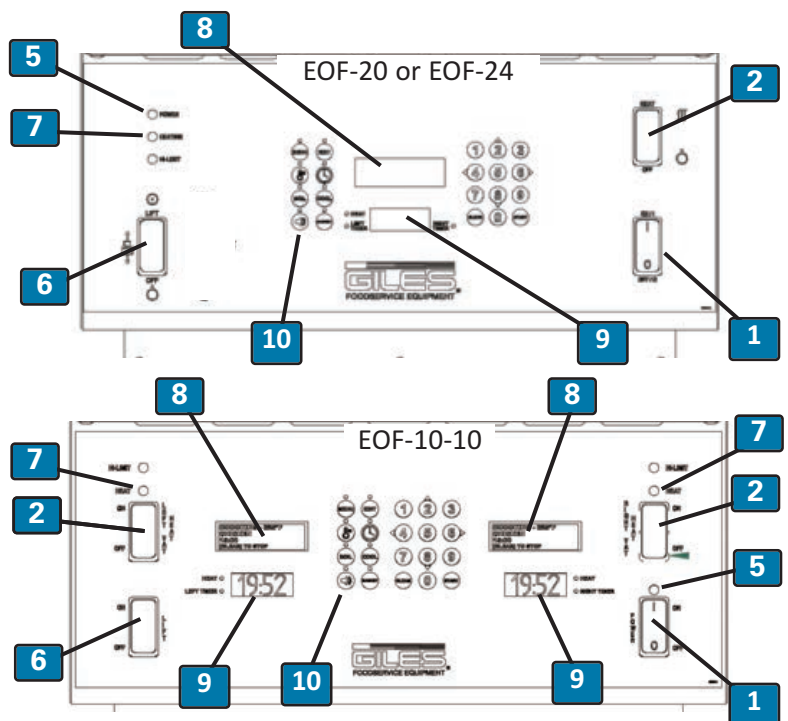

- Place Heat Switch (2) in the [HEAT] or [ON] position; the Heat Light (7) will illuminate and oil should begin heating. The Upper OLED Display (8) will show PREHEATING and the Lower 7-Segment Display (9) shows real-time oil temperature while heating.



**CAUTION** Cooking oil is extremely HOT! Always wear thermal protection, such as oven mitts or gloves, when stirring hot oil.

- It is recommended that oil be stirred occasionally while heating to prevent occurrence of false HI-LIMIT or MAX TEMP alarms. Stir all the way to the bottom of the vat. This is especially important during the initial heat-up of the day, when shortening may be cool and in a thickened state.
- When cooking oil initially reaches the programmed setpoint, an alarm sounds and the Upper OLED Display (8) reads "ALARM STIR OIL". Press the [ALARM] key (10) and vigorously stir the oil. There is a 10 second delay, during which, if temperature drops below setpoint when oil is stirred, the Controller remains in PREHEAT until setpoint is reached again. A second alarm then sounds and the Upper OLED Display reads "ALARM SETPOINT REACHED". Press the [ALARM] key and Controller enters READY state.

Cooking oil should now be evenly heated and ready for cooking.

## 5.2. Cooking Procedure - continued

- 10. Check the oil level, it should now be at the **FULL** Mark (11). Add shortening if needed and stir. If the **HEAT** light turns **ON** after adding additional oil, continue stirring until it turns **OFF** again before cooking.
- 11. Place the Fry Screen (12) into vat with the handles to the side.
- 12. If Basket Lift option is installed, place the Cooking Baskets (13) onto the Basket Carriers (14), otherwise hang baskets on Hanger Bars.

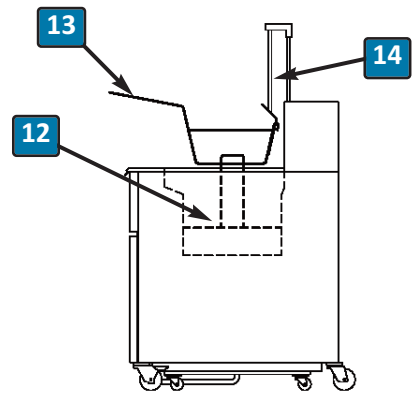
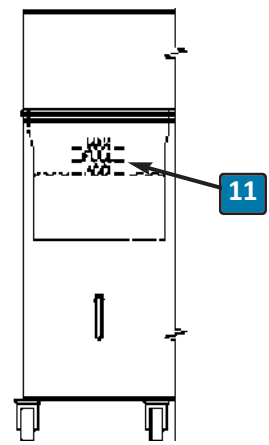

**NOTE: Basket Lift Models:**  
If not desiring to use the Basket Lifts, move Lifts to the raised position and use Basket Carriers (14) as Hangers.

**⚠ WARNING**

During cooking operations, oil level **MUST** be maintained above the indicated minimum (ADD) level. If not maintained above that level, controller alarms will likely occur and heating elements may shutdown. Condition can also cause smoking and poor food quality.

- 13. When cook Baskets are used, it is recommended that uncooked product be placed into them before placing into the hot oil, while held on either Basket Lift Carrier or Basket Hanger. Basket Lift automatically lowers product into oil when cook cycle is started. Uncooked product may also be placed into Baskets after they are placed into oil.

Some Users prefer to use a “batch” cooking method for high-volume operations. In such cases, Baskets are not used. Product is dropped directly into oil and then remove with a scoop-style basket when done.

## 5.2. Cooking Procedure - continued

**CAUTION** Use extreme caution when dropping product directly into HOT cooking oil! There is potential for severe burn injury should unprotected hands contact hot oil, or should an unexpected splash occur. Loading excessively wet food items or larger than recommended load sizes into the cook vat can lead to surge boil and result in an overflow of HOT cooking oil. Exercise due caution when loading food items ... observe how hot oil reacts before continuing.

- If Fryer unit is equipped with Lifts and if necessary, raise Lift to the full [UP] position, see *Section 5.1.7.1, Manually Operating the Basket Lifts*. Position cook Baskets as needed on Lift Carriers or Hanger.
- Confirm or select a Menu Item Preset, or manually enter a desired cooking time for the specific product. See *Section 5.1.5.2, Selecting a Menu Preset for Cooking* or *Section 5.1.4, Manually Setting the Cooking Time*.
- Carefully load product into Basket(s) or directly into the desired “batch” cook vat.

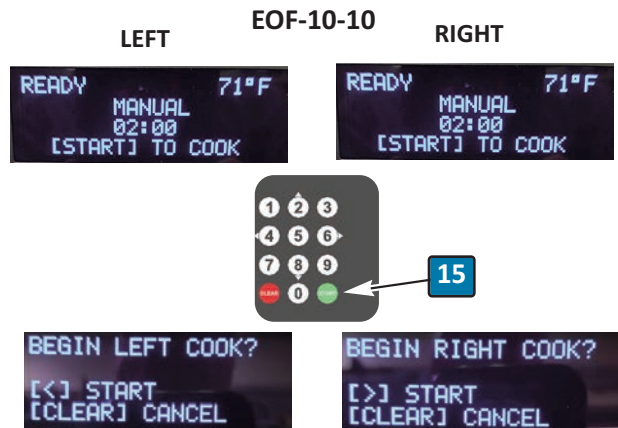
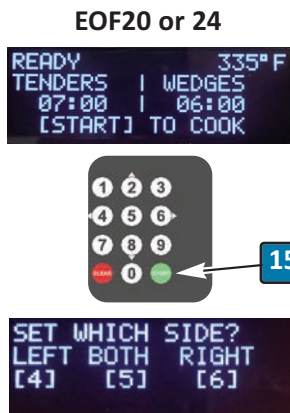

- Press [START] key (15):

**EOF20 or 24** - use keypad to select which Basket side to begin cooking; [4]=LEFT, [5]=BOTH or [6]=RIGHT. Cook settings for both Basket sides are shown on the **Upper OLED Display**.

**EOF10-10** - select Vat side to start ... [<]=LEFT, [6]=RIGHT. Cook settings for each vat are shown on the vat's **Upper OLED Display**.

Programmed cook time begins to countdown on the **Lower 7-Segment Display** as soon as side selection is made.

- As needed, place Baskets with product into vat; manually placed baskets rest on Fry Screen (12).
- If Lifts are installed, cook Basket(s) are automatically be lowered into vat.

- Upper OLED Display** will indicate “COOKING” ... EOF20/24 shows [LEFT - RIGHT or BOTH] ... EOF10-10 shows on applicable vat display. The **Lower 7-Segment Display** shows the cook time remaining and counting down.

## 5.2. Cooking Procedure - continued

**CAUTION** Always wear thermal protective gear, such as oven mitts or gloves, when handling hot Baskets.

19. [STIR ALARM] feature - see *Section 5.1.6, Cooking Cycle Overview* and *User Settings, Section 5.1.8* for details.

If enabled, after a preset amount of the programmed cook time has elapsed, an alarm sounds and the **Upper OLED Display** on EOF20/24 reads **“ALARM STIR LEFT RIGHT or BOTH SIDE”** ... on EOF10-10 each vat side displays separately.

Press the [ALARM] key ⑰ and using the provided stirring utensil ⑯ stir the cooking product. If using Basket Lifts, be careful not to dislodge Basket from Basket Lift Carrier while stirring.

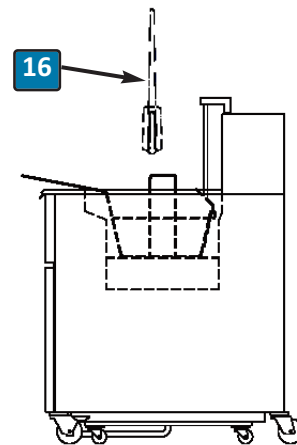

20. When programmed cook time has elapsed, an alarm will sound. EOF-20/24: **Upper OLED Display ⑱** reads **“ALARM DONE COOKING - LEFT RIGHT or BOTH”** ... Appropriate EOF10-10 display ⑱ will read **“ALARM DONE COOKING - LEFT or RIGHT”**. If Lifts are installed, cook Basket(s) will automatically be raised from the hot oil. Press the [ALARM] ⑰ key to silence alarm.

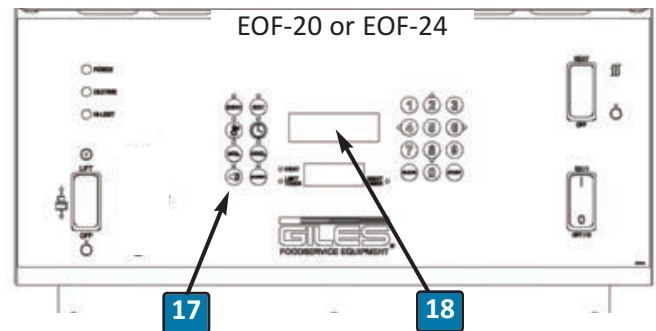

21. As necessary, remove Baskets with cooked product from vat, or Basket Lift, and dump product into Dump Station for draining.

If “batch” cooking large quantity of product, use the provided scoop-style Basket to dip product from oil and place into Dump Station.

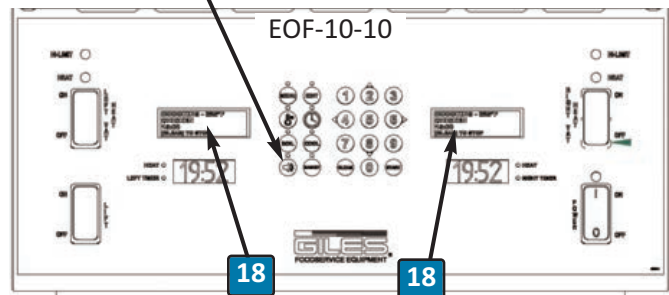

23. After allowing product to adequately drain and while it is still hot, place into food pan for handling according to User standard practices.

23. To continue cooking return to **Step-10**.

To shut-down unit, see *Section 5.7, Normal Shut-Down*.

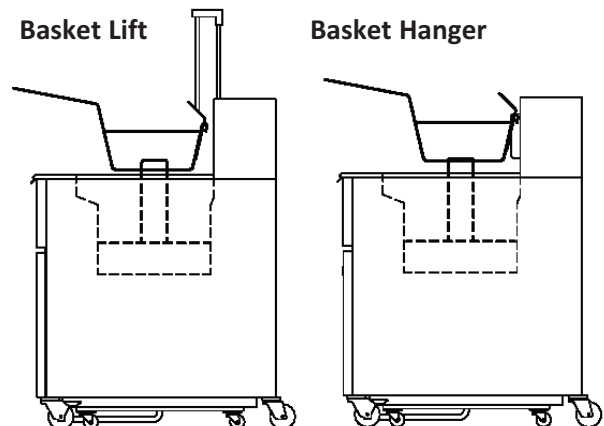

## 5.3. Filtering Used Cooking Oil

This section explains use of the built-in Oil Filtration System, which filters and reconditions cooking oil after use by circulating it through filter media in the Filter Pan. Performing this process as prescribed can effectively increase the useful life of cooking oil by as much as 50%.

Controller has a **FORCE FILTER** feature (see **Section 5.1.8, User Settings**) that can force Users to perform routine oil filtration. **When set to [ON]**, Fryer enters **FILTER MODE** after a certain number of cook cycles [**FILTER COUNT**] have been completed and will be locked-out of further operation until filter cycle is performed. **When set to [OFF]**, Controller only prompts User to filter at completion of every subsequent cook cycle after the filter count is exceeded, until filter a cycle is performed.

**FISH FILTER Menu Item Setting:** When set [**ON**] in a Menu Item Preset, overrides the global **FORCE FILTER** setting to force filtering after only (1) or (2) batches cooked for that Menu Item (typically seafood), see **Section 5.1.5.1, Editing a Menu Item Preset** for more detail.

**Factory-set default:** **FORCE FILTER=[ON]** with **FILTER COUNT=4** ... **FISH FILTER=[OFF]**.

**FORCE FILTER SNOOZE** feature allows one (1) additional cook cycle after **FILTER COUNT** is exceeded. **Factory-set default = [OFF]**. It may be enabled in **User Settings**.



**Never attempt to perform the filter process when shortening is cold. Doing so can clog the filter pump and damage the unit. Oil must be heated to at least 200°F (93°C) for filtering.**

**Always wear thermal protective gear, such as oven mitts, while performing the filtering process. Fryer parts inside the cabinet will be extremely HOT!**

1. It is recommended that oil be filtered after every fourth (4th) load cooked ... **FORCE FILTER** is factory set as described above.
2. Place the Heat Switch (1) of the unit requiring filtering in the **[OFF]** position. **Power Switch MUST remain [ON]**.
3. Open the FFLT Cabinet Door. Disconnect the Filter Pan Hose (2), push the white collar "in" while pulling the Hose from connector. Remove Filter Pan (3) from unit. **Any previous filter residue should have been removed.**
4. **Using Filter Paper:** Ensure that (1) sheet of Filter Paper is installed correctly in Filter Pan and that Hold-down Frame is securely locked in place.  
**Using Steel Mesh Screen:** Ensure screen is free of residue and properly seated in the Filter Pan. Be certain that no debris is trapped underneath the gasket and that Hold-down Frame is securely locked in place.
5. Add approximately 5 oz. of a suitable Filter Powder (**available from Giles, P/N 72004**), distributing evenly over the filter media surface. Use of a good quality filter aid is important to remove soluble impurities and recondition (polish) the oil.
6. Replace Cover (4), if removed, reposition Pan and reconnect Filter Pan Hose, push white collar "in" while inserting brass fitting into connector. Fit must be tight and secure.

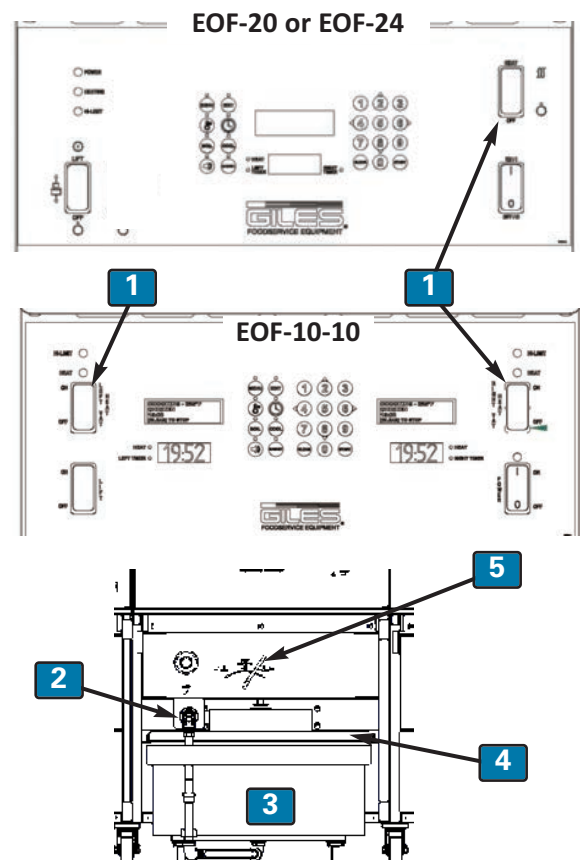

Continued on Next Page

## 5.3. Filtering Used Cooking Oil - continued

**⚠ DANGER** During the next steps cooking oil is drained from the vat, exposing the heating elements. Even though safety interlocks are in place, failure to place the HEAT Switch in the [OFF] position before draining could result in fire. **ALWAYS CONFIRM THAT THE HEAT SWITCH IS [OFF] BEFORE DRAINING COOK VAT.**

**⚠ WARNING**

- Never drain more than one (1) vat at a time into the Filter Pan! The pan only has capacity to hold the oil from one (1) cook vat.
- Never disconnect and attempt to remove the Filter Pan from unit while it contains cooking oil.

7. Confirm that **HEAT** Switch for the unit being filtered remains in the [OFF] position. In the lower FFLT Cabinet ensure the Pump Diverter Valve Handle (5) is in the [OIL RETURN] position.

**On the unit being filtered:** Unhook and slowly pull Drain Valve Handle (6) out to the [OPEN] position. Cooking oil should begin draining into the Filter Pan.

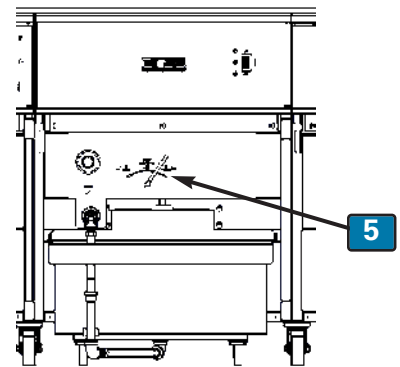

**NOTE:**  
If oil does not readily drain, use the provided Drain Brush and/or Drain Clean-out Tool to break up crumbs or residue that might be blocking the vat drain opening.

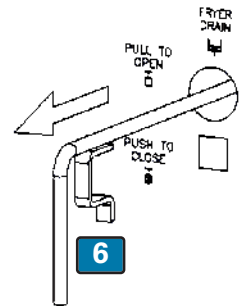

8. **On the Fryer unit being filtered:** Set the Oil Return Valve handle (7) to the [VAT FILL] position.

**IMPORTANT!**  
Oil Return Valves on all other vats **MUST** be in the [CLOSE] position.

9. Allow **ALL** oil to completely drain into the Filter Pan then place the Pump Switch (8) on the FFLT Panel to the [ON] position.

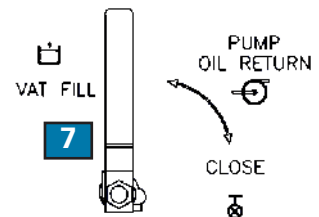
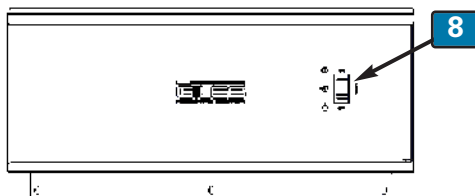

Continued on Next Page

## 5.3. Filtering Used Cooking Oil - continued

10. Used cooking oil will begin to circulate ⑨ through the filter media in the Pan and return to the fry vat. Leave the Drain Valve open and allow oil to continually circulate through the system for about **five (5) minutes**. During this time, remove Crumb Screen from vat and use the various provided brushes to scrub the vat surfaces and heating elements, allowing residue to be flushed into the Filter Pan.

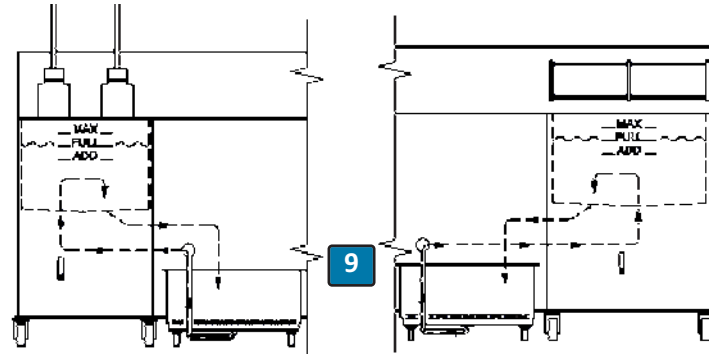

11. After about 5 minutes, replaced the Crumb Screen if removed, push in and lock the Drain Valve Handle ⑩ in the [CLOSE] position. Allow the vat to refill with the reconditioned oil. When all oil has been pumped back to the vat, air bubbles will appear at the pump discharge inside the vat.

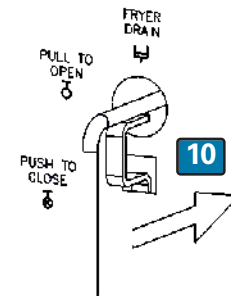

12. After the Vat has refilled, place the Pump Switch ⑪ in the [OFF] position.

13. Position the Pump Oil Return Lever ⑫ on the unit being filtered to the [CLOSE] position.

14. Be sure the vat contains the proper level of cooking oil ... add if needed.

15. Fryer unit should now be ready to **PREHEAT** back to the setpoint temperature. If **FORCE FILTER** is [ON], the unit will remain in **Filter Mode** until the actual oil temperature registered by the Controller drops below **290°F**. Typically, the filtering process will reduce oil temperature sufficiently to reset Fryer to normal operation.

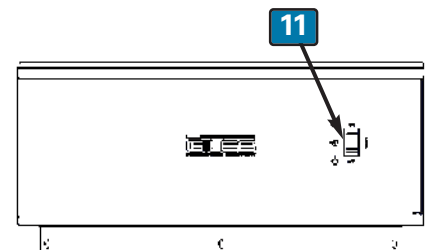

15. To continue cooking, See **Section 5.2, Cooking Procedure**.

To discontinue cooking, See **Section 5.6, Normal Shut-Down**.

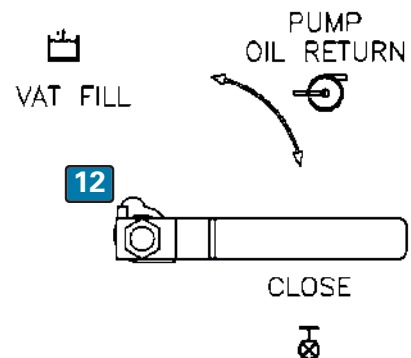

## 5.4. Removal of Waste Cooking Oil from Fryer

This section explains the procedure for removing waste cooking oil from Fryer for disposal. Oil must be removed before a **Boil-Out procedure** can be performed. In this section a Giles Oil Caddy (**not included**) is depicted for oil disposal; any suitable disposal system can be used.

### CAUTION

Never attempt to pump cold shortening. Doing so can clog the filter pump and damage the unit. Oil must be heated to at least 200°F (93°C) before attempting to pump.

1. If cooking oil is cold, heat to at least 200°F (93°C).
2. Confirm the Power Switch ① and Heat Switch ② are in the [OFF] position.
3. Be sure the Filter Pan ③ and the Filter Pan Cover ④ are in place. Confirm the Filter Pan Hose ⑤ is properly connected to the unit. Verify the Pump Discharge Valve Handle ⑥ inside the FFLT Cabinet is in the [TO FRYER] position.

### DANGER

During the next steps cooking oil is drained from the vat, exposing the heating elements. Even though safety interlocks are in place, failure to place the HEAT Switch in the [OFF] position before draining could result in fire. **ALWAYS CONFIRM THAT THE HEAT SWITCH IS [OFF] BEFORE DRAINING COOK VAT.**

### WARNING

- Never drain more than one (1) vat at a time into the Filter Pan! The pan only has capacity to hold the oil from one (1) cook vat.
- Never disconnect and attempt to remove the Filter Pan from unit while it contains cooking oil.

5. Slowly unlock and pull the Drain Valve Handle ⑦, of the Fryer unit being serviced, to the [OPEN] position and allow ALL oil to completely drain into the Filter Pan.

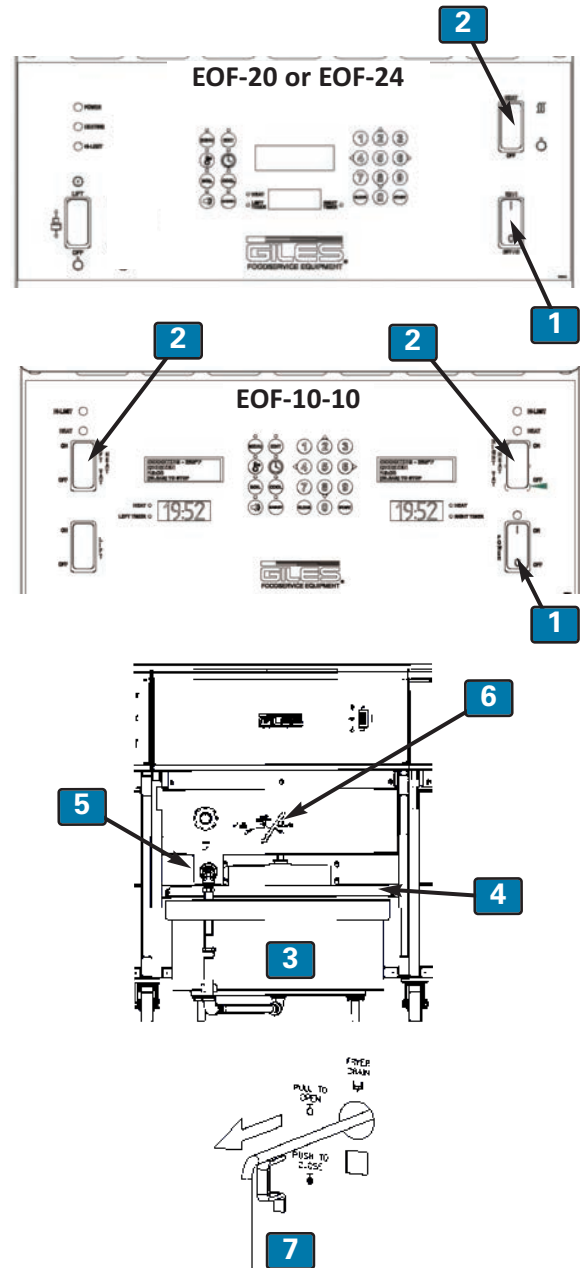

Continued on Next Page

## 5.4. Removal of Waste Oil Cooking from Fryer - continued

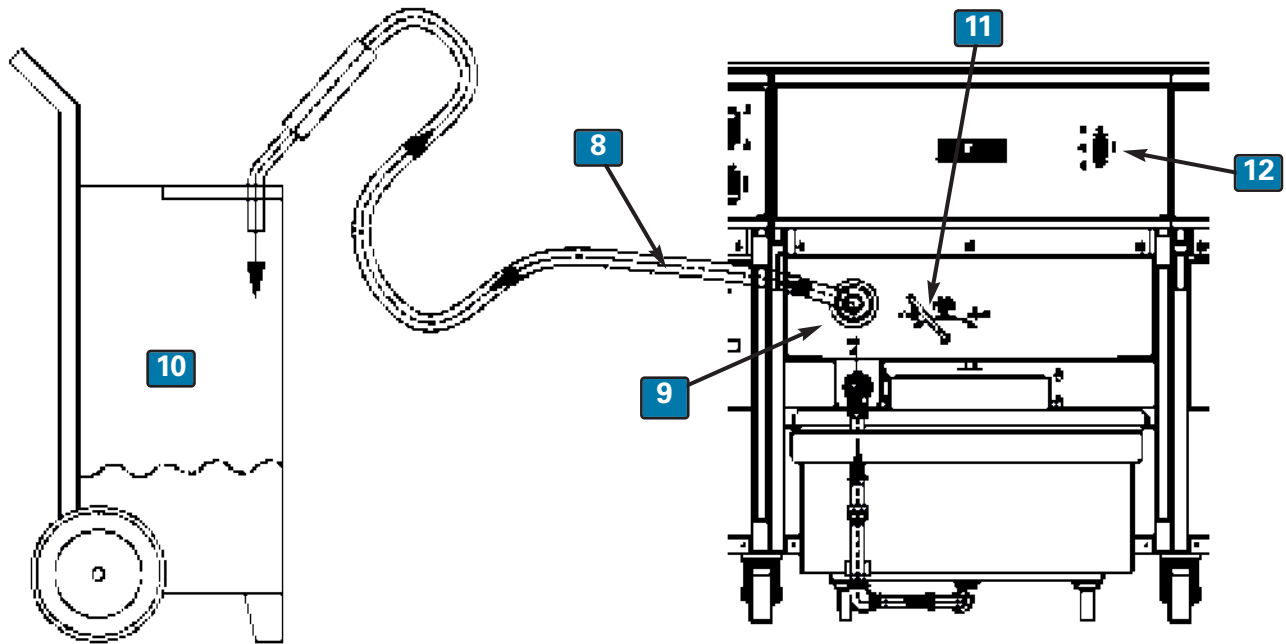

6. Connect the supplied Waste Oil Discharge Hose (8) to the Discharge Hose Coupling (9).
7. Place the discharge wand end into an appropriate waste oil Disposal Container (10) (Giles Oil Caddy is shown). **Container must be heat-resistant.**
8. Rotate the Pump Discharge Valve Handle (11), inside the FFLT Cabinet, to the [TO DISCHARGE HOSE] position.

### **WARNING**

If intending to hold the Discharge Hose during the next step, be sure to wear some type of thermal hand protection, such as mitts or gloves. Parts of the hose assembly can become very HOT!

9. Place the Pump Switch (12) in the [ON] position. Allow the pump to run until all waste oil has been pumped into the waste oil Disposal Container.
10. After waste oil has been removed from the Filter Pan, return Pump Switch to the [OFF] position.

## 5.4. Removal of Waste Cooking Oil from Fryer - continued

11. Confirm Power Switch (13) is in the [OFF] position.
12. Push the Drain Valve Handle (14) to the [CLOSE] position, tuck tab behind panel.
13. Place the Pump Discharge Valve Handle (15), inside the FFLT Cabinet, in the [TO FRYER] position.

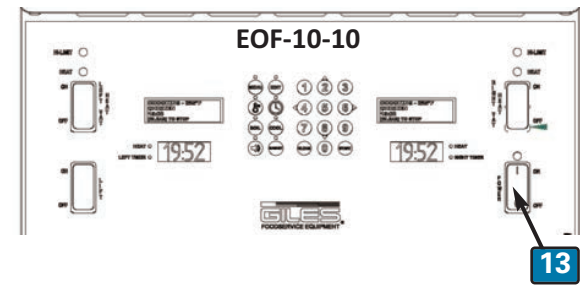
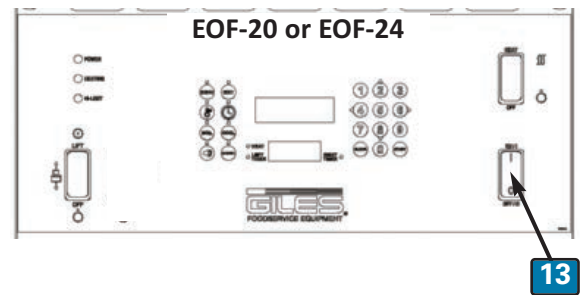

**⚠ WARNING**

When performing the next steps be sure to wear thermal protection, such as oven mitts or gloves. Some parts of the Discharge Hose assembly and coupling will become very HOT!

14. Remove the Discharge Hose from the Discharge Hose Coupling and drain any oil remaining in the hose into the waste oil Disposal Container.
15. Allow the Filter Pan to thoroughly cool. Remove and thoroughly clean the Filter Pan and Filter Pan Cover, see *Section 6.2, Cleaning the Filter Pan & Renewing Filter Media*.
16. To perform a Boil Out on the unit see *Section 6-01, Boil Out Procedure*.

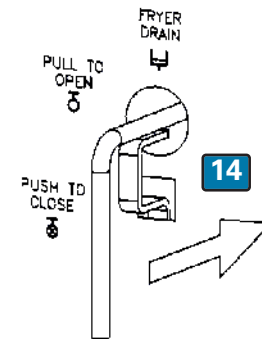

To shut down the unit see *Section 5-06, Normal Shut-Down*.

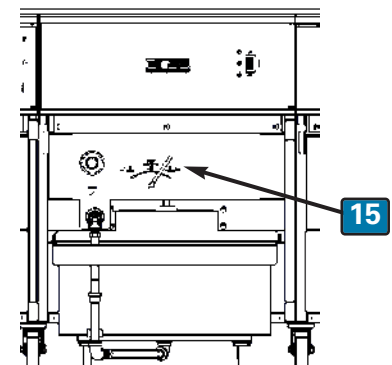

## 5.5. *Optional Renewable Filter Media Screen (SSFS)*

This section describes use and care of the renewable, stainless steel, **Filter Screen (SSFS)**. The **SSFS** is a direct replacement for paper filter media that can be cleaned and reused many times. It is an optional item (**Giles #41017**) that is purchased separately as a filter paper alternative.

### USAGE INSTRUCTIONS:

---

1. In a clean, dry Filter Pan, place the **SSFS** in Pan same as filter paper. **DO NOT use filter paper and Screen together.**
2. Be sure that the edge gasket is flat against Pan bottom. Position the Hold-down Frame and lock into place with the locking levers. Levers may not fully close when using the Screen ... this will not affect performance.
3. For best filtering results, always use a good quality filter aid, such as **Giles #72004 Filter Powder**. Distribute the prescribed amount evenly over the surface, same as with filter paper.
4. After performing a regular filtering cycle, see **Section 5.3, Filtering Used Cooking Oil**, clean accumulated filter sediment from the **SSFS** surface with the supplied Crumb Scoop, or other suitable utensil, and discard. It might be necessary to remove the Screen to brush remaining residue from its surface.
5. If Screen is removed, do not allow filter residue to fall into the Filter Pan bottom and be sure to wipe any residue from the edge gasket. Reinstall screen with the soiled side up.



### SCREEN CLEANING INSTRUCTIONS:

---

1. It is not necessary to clean the **SSFS** Filter Screen after every filtering cycle.
2. At least **WEEKLY**, remove the **SSFS Screen** and clean in the sink. Use **ONLY** hot water and a soft bristle brush. **DO NOT USE SOAP or OTHER DETERGENT CLEANERS** when washing the Screen. Soap residue cannot effectively and completely be rinsed from the screen and will eventually be transferred to cooking oil over time, affecting oil life and quality. **DO NOT USE OVEN CLEANERS or CAUSTIC PRODUCTS** to clean the Screen. Hazardous residue can be transferred to cooking oil and these chemicals will damage the silicone edge gasket.
3. Before reinstalling the clean **SSFS** in the Filter Pan, shake off excess water and dry with a clean towel. Be certain screen is completely dry before using. If possible, it is best to allow screen to dry overnight.
4. Take care not to cut or tear the silicone edge gasket.  
Inspect Screen weekly for damage, such as fraying, holes, damaged gasket, etc. A damaged screen should be removed from service and replaced immediately.

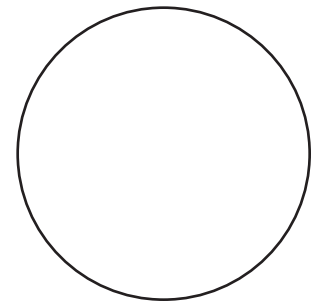

## 5.6. Normal Shutdown

1. Set Heat Switch ① on all Fryers to [OFF] position.
2. Place Power Switch ② on all Fryers in the [OFF] position. Green Power lights will turn [OFF].
3. If required, turn off supply power to each Fryer unit at the main electrical panel.

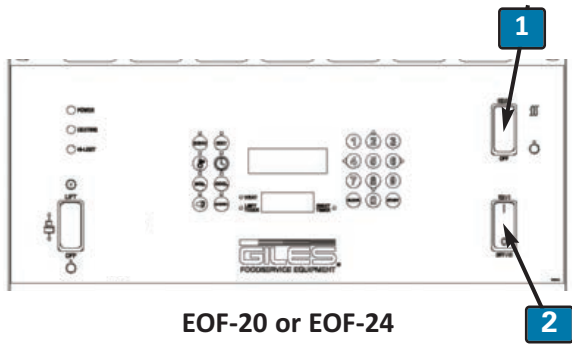

EOF-20 or EOF-24

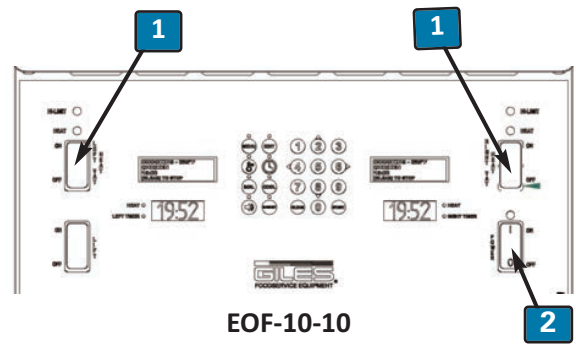

EOF-10-10

## 5.7. Emergency Shutdown

In case of emergency, remove all supply power to the unit by switching off the main building circuit breaker.

## 6. Cleaning

This section explains cleaning procedures for **EOF Series Banked Fryers**. Giles recommends that general cleaning, including Filter Pan cleaning, be performed on a daily basis, at a minimum.

**⚠ DANGER**

- **DO NOT** wash down the unit interior or exterior with water from a spray hose or any pressure-type washer.
- Failure to comply with **DANGER** notices will result in death or serious injury, equipment or property damage, and void the warranty.

### 6.1. Boil-Out Procedure - Cleaning the Fry Vat

This section explains use of the Boil-Out procedure for cleaning the Fryer cook vats. A Boil-Out procedure must be performed before cooking in new equipment and should be performed each time the cooking oil is changed. For proper fryer maintenance and operation, a Boil-Out Procedure should be performed every 7 to 14 days, at a minimum.

**⚠ WARNING**

**DO NOT** leave the Fryer unattended during this procedure as it may become necessary to adjust the heat setting to prevent a rolling boil and vat overflow. An overflow can result in serious equipment damage.

1. Remove waste oil from the fryer unit, see *Section 5.5, Removal of Waste Cooking Oil from Fryer*.
2. Ensure the Drain Valve Handle **①** is pushed in and locked in the **[CLOSE]** position and the Power Switch **③** is in the **[OFF]** position.
3. Fill the vat with clean water to the **FULL** level mark **②**.
4. Use a reputable **Boil-Out/Fryer Cleaning** product and follow the manufacturer's usage instructions. Add the recommended amount of product to water in the vat and stir to mix.

Fryer cleaner is available from Giles ... Order part number: **72003-1**, 8-Lb Container or **72003**, Case of 4 Containers.

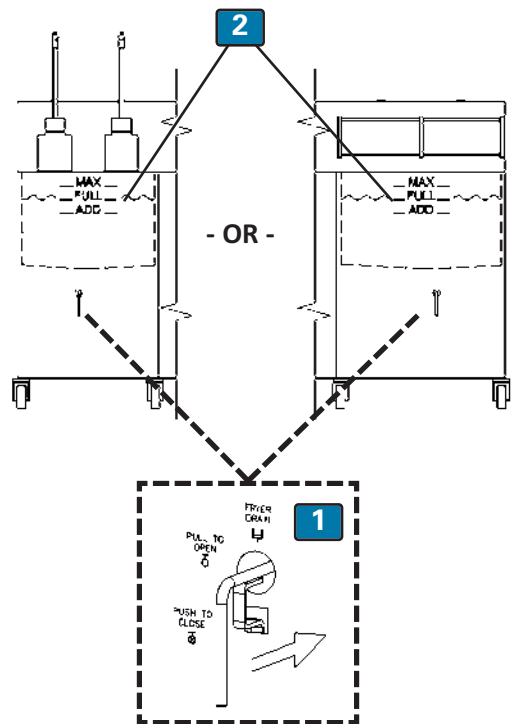

**⚠ CAUTION**

Closely follow the product manufacturer's usage instructions and hazard warnings. Many commercially available cleaners contain caustic chemicals and require special precautions when used. Improper use could damage the fryer and potentially present a personal injury hazard.

Continued on Next Page

## 6.1. Boil-Out Procedure - Cleaning the Fry Vat - continued

5. Place Power Switch (3) in the [ON] position and proceed through power-up, see *Section 5.1.10, Power Up Procedure*.
6. Place Heat Switch (4) in the [HEAT] or [ON] position.
7. When the fryer enters PREHEAT, press the [BOIL] key (5). Controller enters **BOIL OUT MODE**, temperature setpoint changes to **200°F**, and cycle time begins to countdown from **30 minutes**. Boil-Out solution will begin to heat. **EOF10-10**: Both vat sides begin boil-out simultaneously.

**NOTE:** If a different boil-out temperature or time is required, the settings can be changed in *USER SETTINGS, Section 5.1.8*. [BOIL TEMP] is variable between 185° - 208°F. [BOIL OUT TIME] is variable between 1 - 45 minutes.

**CAUTION** DO NOT allow a “rolling boil”, which can result in the vat overflowing, cause damage to the unit and possible personal injury. This is not necessary to achieve cleaning action.

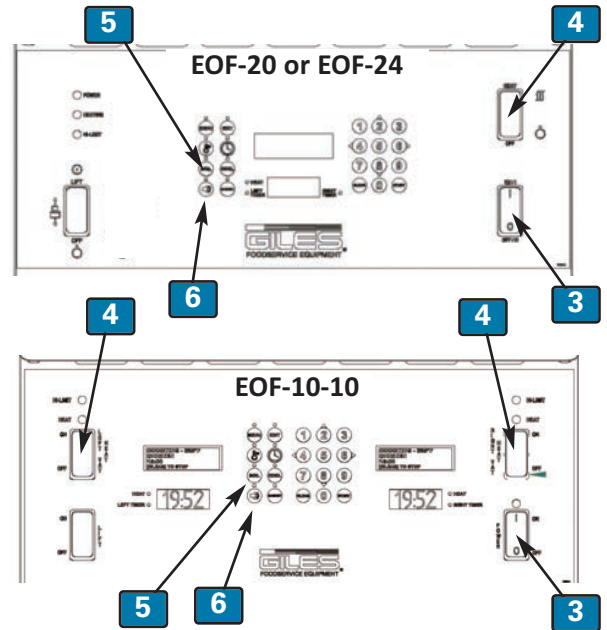

8. At the completion of the Boil-Out cycle time, an alarm sounds and the **Upper Display** shows the message “**DONE COOKING**”.
9. Press the [ALARM] key (6).
10. Return Power Switch (3) and Heat Switch (4) to the [OFF] position.

**WARNING** NEVER drain boil-out solution into the Filter Pan or run it through the filter system using the Filter Pump. The solution is caustic and will damage the pump and other components. Warranty will be void!

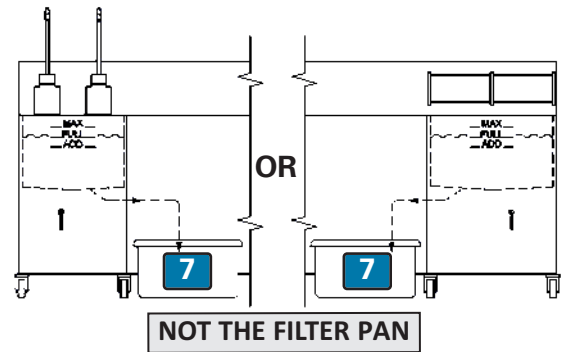

11. Position a suitable **Heat Resistant Container (7)** (not supplied) beneath the Fryer Drain. **IMPORTANT!** General purpose plastic containers are typically not suitable as they may break or melt, resulting in spillage.
12. Unlock and slowly pull the Drain Valve Handle (8) to the [OPEN] position.

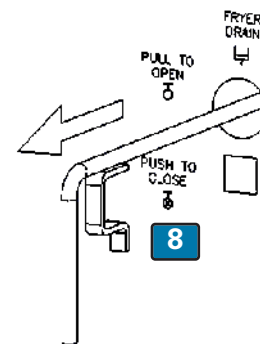

## 6.1. Boil-Out Procedure - Cleaning the Fry Vat - continued

13. Remove Screen from the vat and, as needed, use Pot Brush & Element Brush to scrub residue from vat surfaces and heating elements. Rinse and flush the vat thoroughly with clean warm water. **Note: Take care to avoid damage to the temperature probes located inside the vat front and attached to heating elements. IMPORTANT! While draining and rinsing vat, give close attention to the catch container to avoid overflowing ... empty container as necessary.**

14. Completely dry vat and heating elements with a clean, sanitized, dry towel. Properly dispose of the used boil-out solution.

15. Push in and lock Drain Valve Handle (8) in the [CLOSE] position.

16. Clean Filter Pan and replace Filter Media. See *Section 6.2, Cleaning the Filter Pan & Renewing Filter Media.*

17. Re-install Filter Pan Cover (9).

18. Position Filter Pan (10) under unit and connect Filter Pan quick-disconnect Hose (11).

19. Restart the fryer for cooking. *See Section 5.2, Cooking Procedure.*

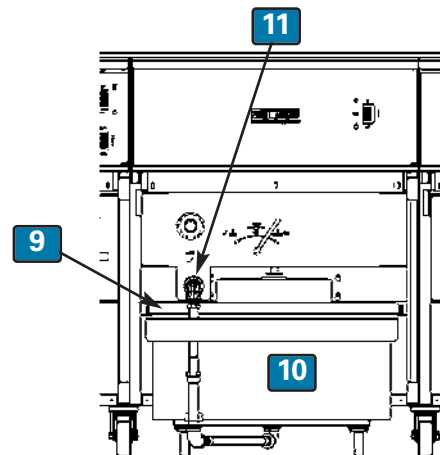
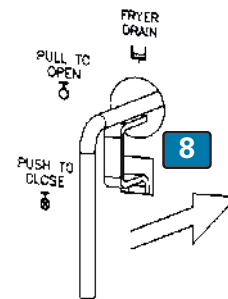

## EOF SERIES FRYERS

## Cleaning

### 6.2. Cleaning the Filter Pan & Renewing Filter Media

This section explains the procedure for cleaning the Filter Pan and refreshing the filter media - either disposable filter paper or reusable steel mesh screen (SSFS). At a minimum, this cleaning should be performed **once per day of operation**, and each time a Boil-Out procedure (**Section 6.1.**) is performed.

**CAUTION** Wear thermal protective gear to protect hands from potentially hot parts.

**NOTE:** Unless otherwise noted, parts can be cleaned with warm soapy water or a mild, biodegradable degreaser, such as Simple Green®. After cleaning parts should be thoroughly rinsed with clean water and dried completely.

1. With Filter Pan removed from Fryer, remove and clean Crumb Screen (1), if being used.
2. Use the supplied metal **Crumb Scoop** to remove as much of the accumulated filter sediment as possible from the filter media surface, particularly around the edges. This will help prevent debris from falling through the perforated support screen and potentially causing the filter pump to clog.
3. Remove and clean the **Filter Pan Cover** (2). Dry thoroughly.
4. Turn the four Levers (4) to disengage the **Hold-down Frame** (5). Remove, clean and dry Frame thoroughly.
5. Remove the soiled Filter Media (6), either Paper or Mesh Screen (SSFS).

**Paper:** Carefully roll up soiled sheet and discard; avoid allowing filter debris to fall through the permanent perforated support screen (7) in the Filter Pan bottom.

**SSFS Screen:** Remove the screen; avoid allowing filter debris to fall through the permanent, perforated support screen (7) in the Filter Pan bottom. Using only hot water and a soft bristle brush, clean Screen in sink. Shake out water and dry with clean dry towel. Screen must be completely dry before re-installing in Filter Pan. See **Section 5.5, Optional Renewable Filter Media Screen.**

**DO NOT use soaps or cleaners of any kind for washing the Filter Screen!**

6. Thoroughly clean and dry the Filter Pan (8). Flush out any debris that may have fallen through the perforated support screen. Be sure to flush and drain all water from the Filter Pan hoses.

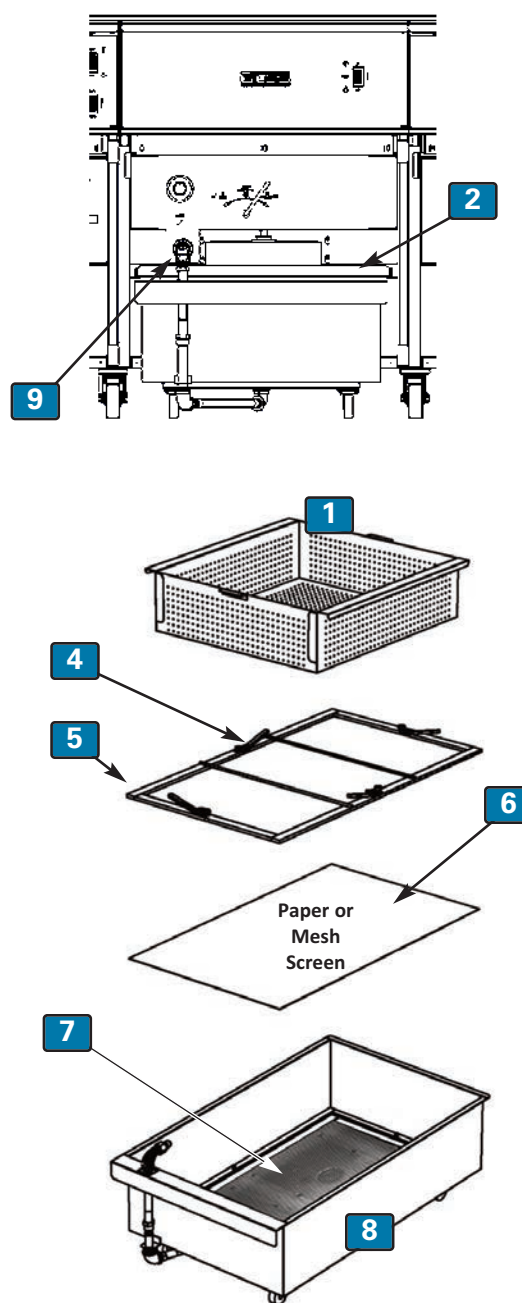

## 6.2. *Cleaning the Filter Pan & Renewing Filter Media - continued*

7. As applicable, reassemble the Filter Pan with either (1) new sheet of Filter Paper, or a clean dry **SSFS Screen**.
8. Reinstall Filter Pan Cover on unit, position assembled Filter Pan under Fryer and re-connect the quick-disconnect Hose **9**.

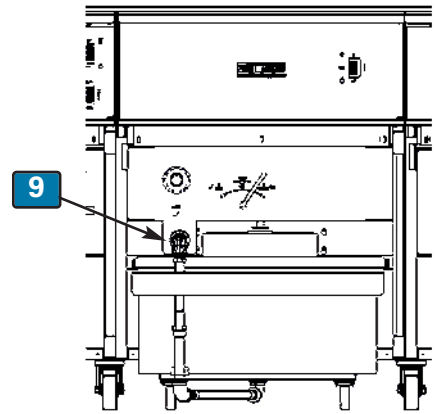

**NOTE: Stainless Steel Filter Screen (SSFS)**

With proper use and care, this reusable filter screen should have a long service life. It should be replaced if it becomes torn, punctured, frayed or if the silicone sealing gasket around the edge becomes significantly deteriorated.

Proper use of a suitable filter aid is essential to the performance of this mesh filter.

**7. Troubleshooting**

This section describes troubleshooting procedures. **IMPORTANT! Most troubleshooting and repairs should only be performed by qualified service technicians.** Users should only attempt actions involving operational procedures. For more detailed professional evaluation, wiring diagrams are provided for each unit; attached to the Back Panels.

**7.1. Temperature Control System**

Problem	Probable Cause	Corrective Action
<b>FRYER WILL NOT TURN ON:</b> No power light	A. Not connected to power supply	Connect to proper power supply
	B. Supply power circuit breaker tripped	Check circuit breakers in electrical panel
	C. Blown fuse on unit	Check fuses on back of unit (access covers must be removed)
	D. Faulty fuse holder	Replace fuse holder on unit (access covers must be removed)
	E. Faulty power switch	Replace power switch
	F. Incorrect power supply voltage	Connect unit to proper power supply
<b>FRYER WILL NOT HEAT:</b> Power light <b>ON</b> ; Heat light <b>OFF</b>	A. Heat Switch not placed in the <b>[HEAT]</b> or <b>[ON]</b> position	Place Heat Switch in correct position for operation.
	B. Power-up not complete, <b>“POWER FAILURE”</b> message displayed	Press <b>[START]</b> key to enter <b>PREHEAT</b>
<b>FRYER WILL NOT HEAT:</b> Power light <b>ON</b> Heat Switch in <b>[HEAT]</b> / <b>[ON]</b> position Heat Light is <b>OFF</b>	A. Temperature setpoint is below the actual oil temperature	Set controller to higher temperature to verify; if setpoint is correct begin cooking,
	B. Drain Valve is open; alarm sounding, error msg displayed	Close & lock Drain Valve, press alarm reset on controller
	C. Faulty unit Controller	Replace Controller
	D. Variable temperature sensor is shorted, or open	Replace sensor
	E. Loose or faulty wiring in heat control circuit	Inspect and repair wiring
	F. Faulty Contactor	Replace faulty Contactor
	G. Faulty heating element	Replace faulty element
	H. Faulty Heat Switch	Replace Heat switch
	I. Alarm condition exists or fryer in Filter Mode <b>[FORCE FILTER]</b> .	Address error, consult Manual <b>Section 5</b>

<b>7.1. Temperature Control System - continued</b>		
Problem	Probable Cause	Corrective Action
<b>FRYER HEATING SLOWLY:</b> Slow recovery Heat Light staying <b>ON</b> continuously	A. Incorrect cooking procedures	Consult Operation Manual for proper procedures
	B. Heating element failing	Replace faulty element
	C. Contactor failing	Replace faulty contactor
	D. Loose wiring in heat control circuit	Inspect and repair wiring
	E. Faulty power switch	Replace power switch
	F. Low power supply voltage	Correct the power supply
<b>FRYER HEATS SLOWLY:</b> Short Cycling; Heat Light <b>CONTINUOUSLY</b> cycling <b>ON &amp; OFF</b>	A. Low power supply voltage	Correct the power supply
	B. Variable temperature sensor too close to heating element	Reposition sensor to proper location
	C. Faulty cooking Controller	Replace Controller
<b>ERRATIC OIL TEMPERATURE:</b>	A. Faulty temperature sensor	Replace sensor probe
	B. Contactor failing	Replace faulty contactor
	C. Faulty cooking Controller	Replace Controller
	D. Loose wiring in heat control circuit	Inspect and repair wiring
<b>OIL SMOKING:</b>	A. Oil is old, used too long	Boil-out vat, fill with fresh oil
	B. Cooking temperature too high	Check temperature setting, adjust
	C. Heating elements are dirty	Clean vat (boil-out), scrub elements with provided brushes
	D. Faulty heating element	Replace faulty element
	E. Improper voltage for elements installed in unit	Supply proper voltage power to unit
	F. Oil level is <b>LOW</b>	Keep oil at <b>FULL</b> level (without product)

<b>7.1. Temperature Control System - continued</b>		
<b>Problem</b>	<b>Probable Cause</b>	<b>Corrective Action</b>
<b>FRYER WILL NOT HEAT:</b> Power Light <b>ON</b> Heat Switch in <b>[HEAT] / [ON]</b> position High-Limit Light <b>ON</b>	A. Power surge	Place Power Switch in <b>[OFF]</b> for 5 seconds, return to <b>[ON]</b>
	B. Contactor is sticking	Replace faulty Contactor
	C. High-Limit board has failed	Replace faulty control board
	D. High-Limit sensor shorted, or open	Replace sensor probe
	E. Incoming power line noise	Install line filter, or remove source of line noise

<b>7.2. Oil Filtration System</b>		
<b>Problem</b>	<b>Probable Cause</b>	<b>Corrective Action</b>
<b>OIL WILL NOT PUMP THROUGH FILTER SYSTEM, BACK TO FRYER VAT:</b>	A. Pump Switch on FFLT Dump Station panel has not been placed in <b>[ON]</b> position	Place Pump Switch (on the FFLT Panel) in the <b>[ON]</b> position
	B. Air leak in system piping	Check all connections, hoses, filter pan, etc.
	C. Pump motor has failed	Replace faulty motor
	D. Oil Pump is clogged or seized (boil-out run thru pump)	Clean out, free pump and re-oil
	E. Diverter Valve handle inside Dump Station cabinet not in the <b>[TO FRYER]</b> position	Place valve handle (inside FFLT cabinet) in proper position
	F. Pump Oil Return Valve handle is in the <b>[CLOSE]</b> position	Position handle to the <b>[VAT FILL]</b> position
	G. Oil allowed to sit in pump too long; has congealed	Run clean, warm oil through pump
	H. Oil has become too cold to pump, below 200°F (93°C)	Manually remove cold oil from the Filter Pan
	I. Filter Pan not assembled correctly	Assemble Pan correctly (see Manual)
	J. Filter Pan excessively dirty, too much residue accumulation	Clean Filter Pan

<b>7.3. Basket Lift System (Only if Equipped)</b>		
Problem	Probable Cause	Corrective Action
<b>BASKET LIFT WILL NOT OPERATE (UP OR DOWN):</b>	A. Power not <b>ON</b>	Place Power Switch in <b>[ON]</b> position
	B. Basket <b>Lift Switch</b> is not in the <b>[ON]</b> position	Place <b>Lift Switch</b> in <b>[ON]</b> position to enable Basket Lifts
	C. Faulty cooking Controller	Replace cooking Controller
	D. Micro-switch on the Lift assembly out of adjustment	Adjust switch
	E. Faulty Micro-switch on the Lift assembly	Replace switch
	F. Faulty Lift motor	Replace motor
	G. Controller still in <b>PREHEAT</b>	Allow fryer to enter <b>READY</b> state



**NOTES:**

---

## 8. Parts List

This section lists various parts that are, typically, field replaceable on EOF Electric Fryers. It is provided to aid qualified service technicians who are servicing or repairing this equipment. Repair of this equipment should only be attempted by professional kitchen equipment service technicians.

### 8.1 Parts Ordering & Service Information

If assistance or repairs are required, please contact a Giles Manufacturer's Representative to assist with locating an authorized service provider in your area. For further assistance you may contact **GILES Technical/Customer Service Support** as follows:

**IN THE UNITED STATES & CANADA call: 800.554.4537**

**ALL OTHERS call: 334.272.1457**

Normal business hours are 8:00 AM to 5:00 PM Central Time ... calls are handled by an automated answering system. Please follow the recorded prompts to reach appropriate support. If necessary after hours, leave voicemail message ... a representative should respond within 30 minutes.

Website: [www.gfse.com](http://www.gfse.com) Email: [services@gfse.com](mailto:services@gfse.com)

Our goal at Giles is to provide the highest possible quality of service and assistance. To help us accomplish this, please have the following information readily available when calling, along with a brief description of the problem being experienced. Please record the unit information in the table below for quick reference.

<b>Model:</b>	
<b>Serial Number:</b>	
<b>Voltage:</b>	
<b>Phase:</b>	

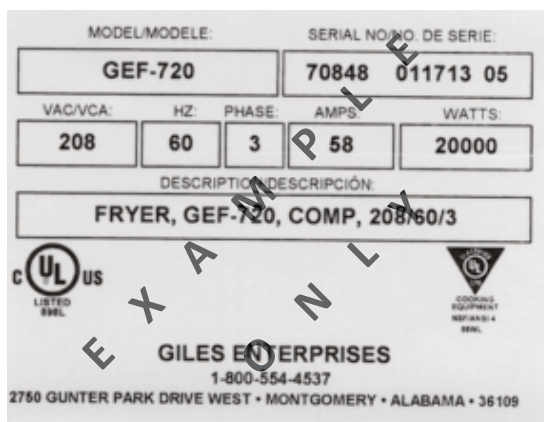

The information can be found on the Serial/Data Label located inside the Fryer cabinet, or on rear cabinet panels.

8.2. EOF-20 Front Header & Control Panel

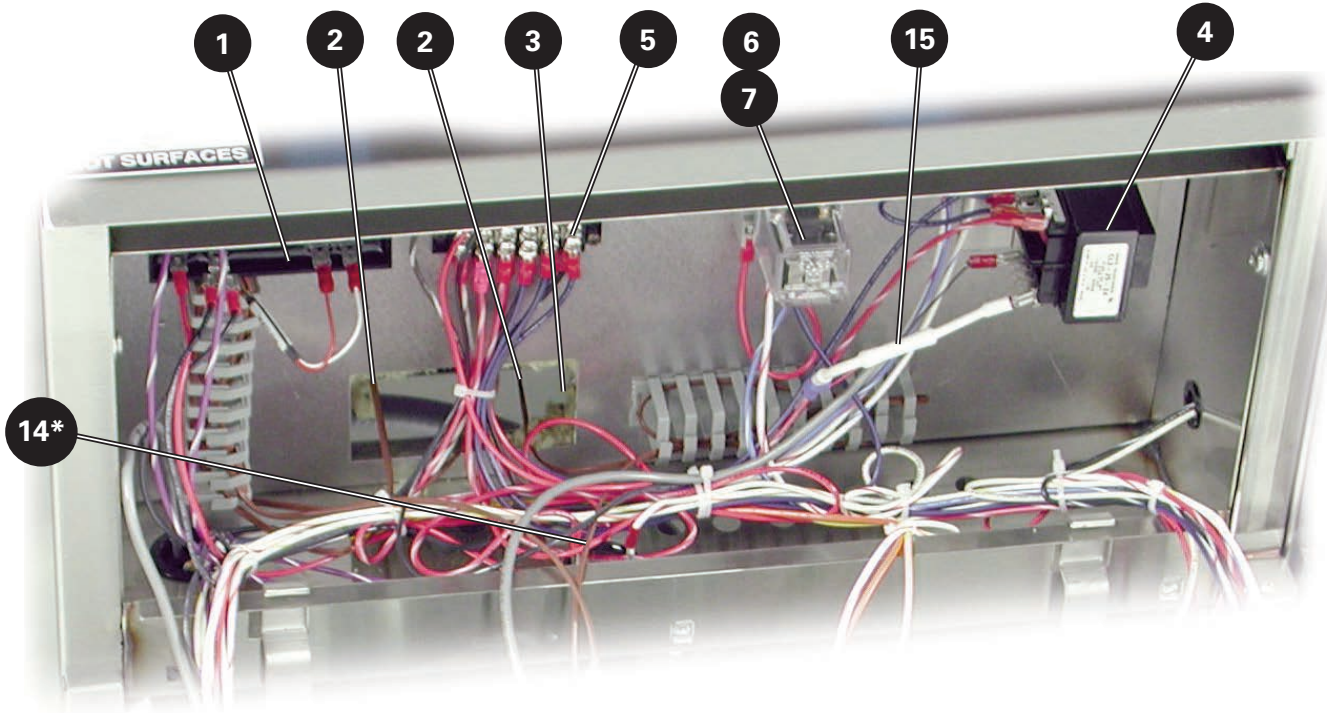

\* Hidden

## 8.2. EOF-20 Front Header & Control Panel

Item	Part Number	Qty	Description
1	<a href="#">23755</a>	1	THERMOSTAT, SAFETY, 450°F
2	<a href="#">20315</a>	2	THERMOCOUPLE, J-TYPE, 13.5, UNGROUNDED (Requires # <a href="#">45111</a> , FERRULE)
3	<a href="#">23900</a>	1	THERMOCOUPLE, J-TYPE, 3, GROUNDED (Requires # <a href="#">45111</a> , FERRULE)
4	<a href="#">20366</a>	1	TRANSFORMER, 20VA, 115/230V, 60HZ, CL2
5	<a href="#">23751</a>	1	TERMINAL BLOCK, 6-POLE
6	<a href="#">21101</a>	1	SOCKET, RELAY, 8 PIN, 300V, 10A
7	<a href="#">21102</a>	1	RELAY, 8 PIN, 240V, 10A
8	<a href="#">21190</a>	1	SWITCH, ROCKER, D.P.S.T. 250V, 10A
9	<a href="#">21052</a>	1 or 2	SWITCH, ROCKER, D.P.D.T. 250V, 10A
10	<a href="#">21379</a>	1	CONTROLLER, CC10, DUAL TIMER
11	<a href="#">20399</a>	1	INDICATOR LIGHT, AMBER, 250V, 0.5W
12	<a href="#">20402</a>	1	INDICATOR LIGHT, RED, 250V, 0.5W
13	<a href="#">20398</a>	1	INDICATOR LIGHT, GREEN, 250V, 0.5W
14*	<a href="#">23782</a>	1	SONALERT, CONTINUOUS TONE, 250V
15	<a href="#">38365</a>	1	FUSE ASSEMBLY, 1A, CONTROLLER POWER TRANSFORMER
16	66234	1	LABEL, CONTROL PANEL, CC10, EOF20

ITEM #9: Only (1) required if unit is not equipped with Auto Basket Lifts

\* Hidden

8.3. EOF-24 Front Header & Control Panel

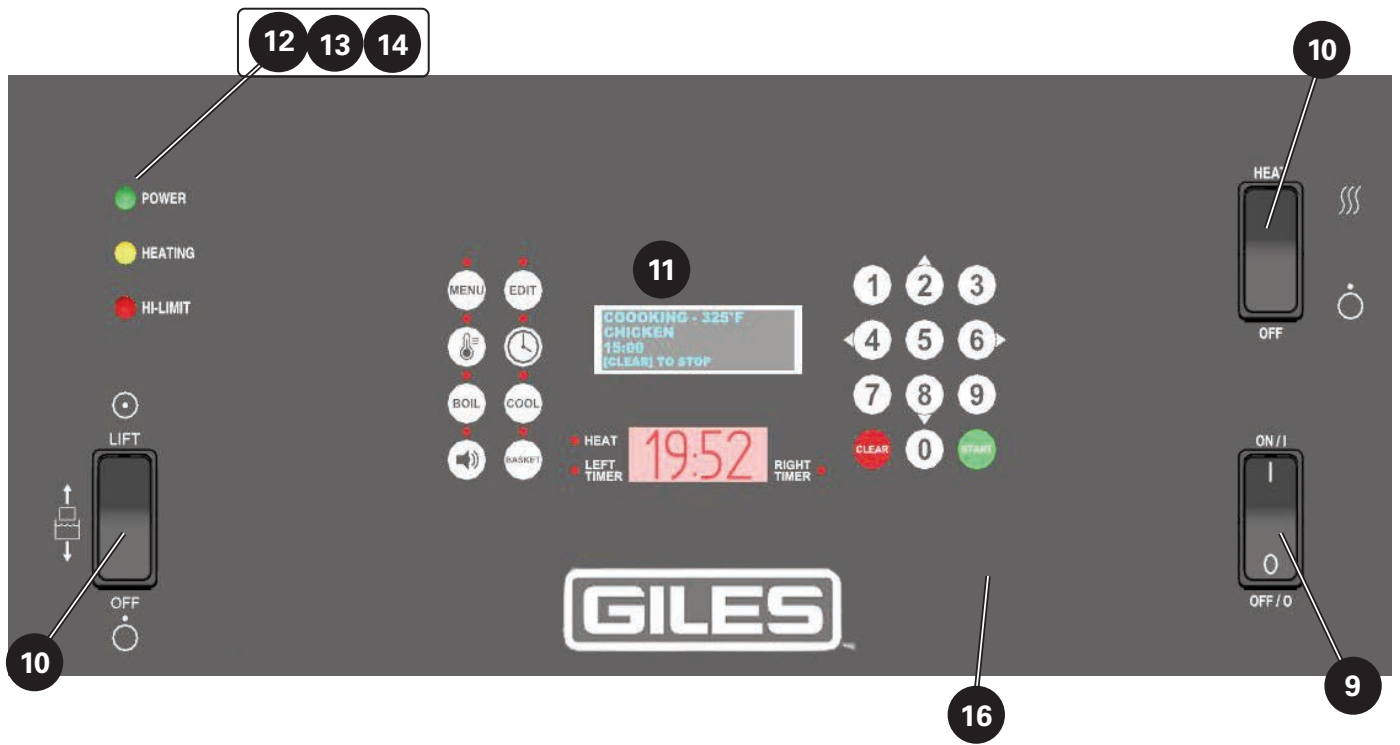
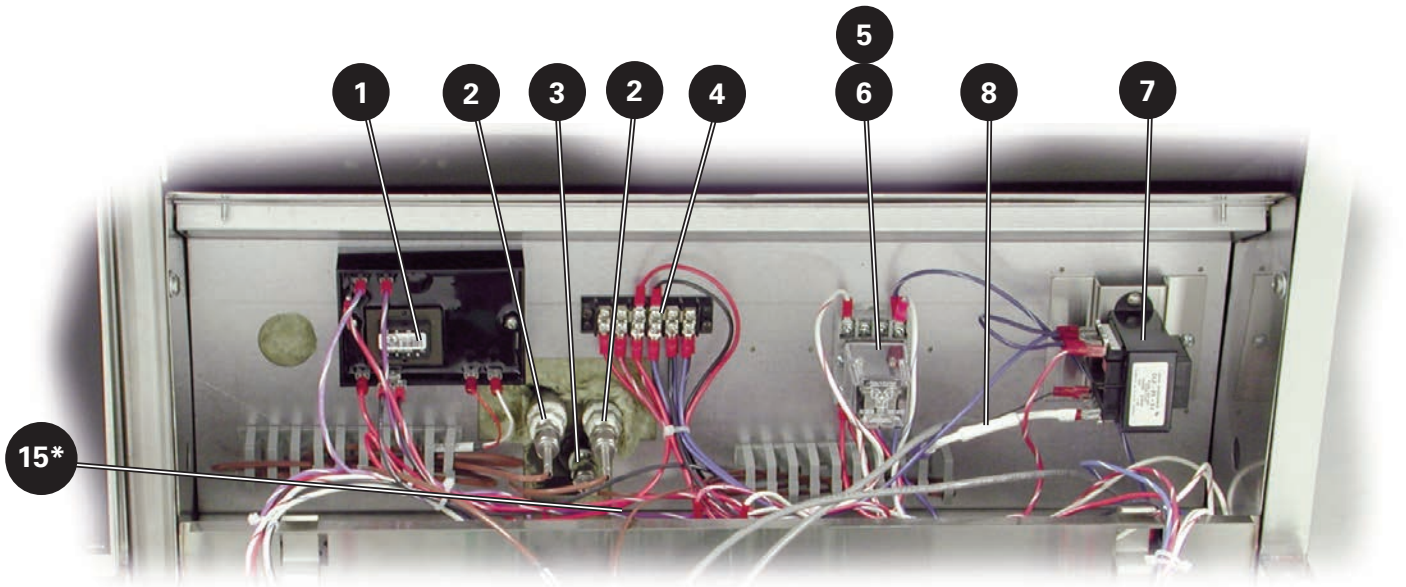

\* Hidden

## 8.3. EOF-24 Front Header & Control Panel

Item	Part Number	Qty	Description
1	<a href="#">23755</a>	1	THERMOSTAT, SAFETY, 450°F
2	<a href="#">20315</a>	2	THERMOCOUPLE, J-TYPE, 13.5", UNGROUNDED <b>(Requires #45111, FERRULE)</b>
3	<a href="#">24222</a>	1	THERMOCOUPLE, J-TYPE, 7", BENT, GROUNDED <b>(Requires #45111, FERRULE)</b>
4	<a href="#">23751</a>	1	TERMINAL BLOCK, 6-POLE
5	<a href="#">21101</a>	1	SOCKET, RELAY, 8 PIN, 300V, 10A
6	<a href="#">21102</a>	1	RELAY, 8 PIN, 240V, 10A
7	<a href="#">20366</a>	1	TRANSFORMER, 20VA, 115/230V, 60HZ, CL2
8	<a href="#">38365</a>	1	FUSE ASSEMBLY, 1A, CONTROLLER POWER TRANSFORMER
9	<a href="#">21190</a>	1	SWITCH, ROCKER, D.P.S.T. 250V, 10A
10	<a href="#">21052</a>	1 or 2	SWITCH, ROCKER, D.P.D.T. 250V, 10A
11	<a href="#">21379</a>	1	CONTROLLER, CC10, DUAL TIMER
12	<a href="#">20398</a>	1	INDICATOR LIGHT, GREEN, 250V, 0.5W
13	<a href="#">20402</a>	1	INDICATOR LIGHT, RED, 250V, 0.5W
14	<a href="#">20399</a>	1	INDICATOR LIGHT, AMBER, 250V, 0.5W
15*	<a href="#">23782</a>	1	SONALERT, CONTINUOUS TONE, 250V
16	66236	1	LABEL, CONTROL PANEL, CC10, EOF24

**ITEM #10: Only (1) required if unit is not equipped with Auto Basket Lifts**

\* Hidden

8.4. EOF10-10 Front Header & Control Panel

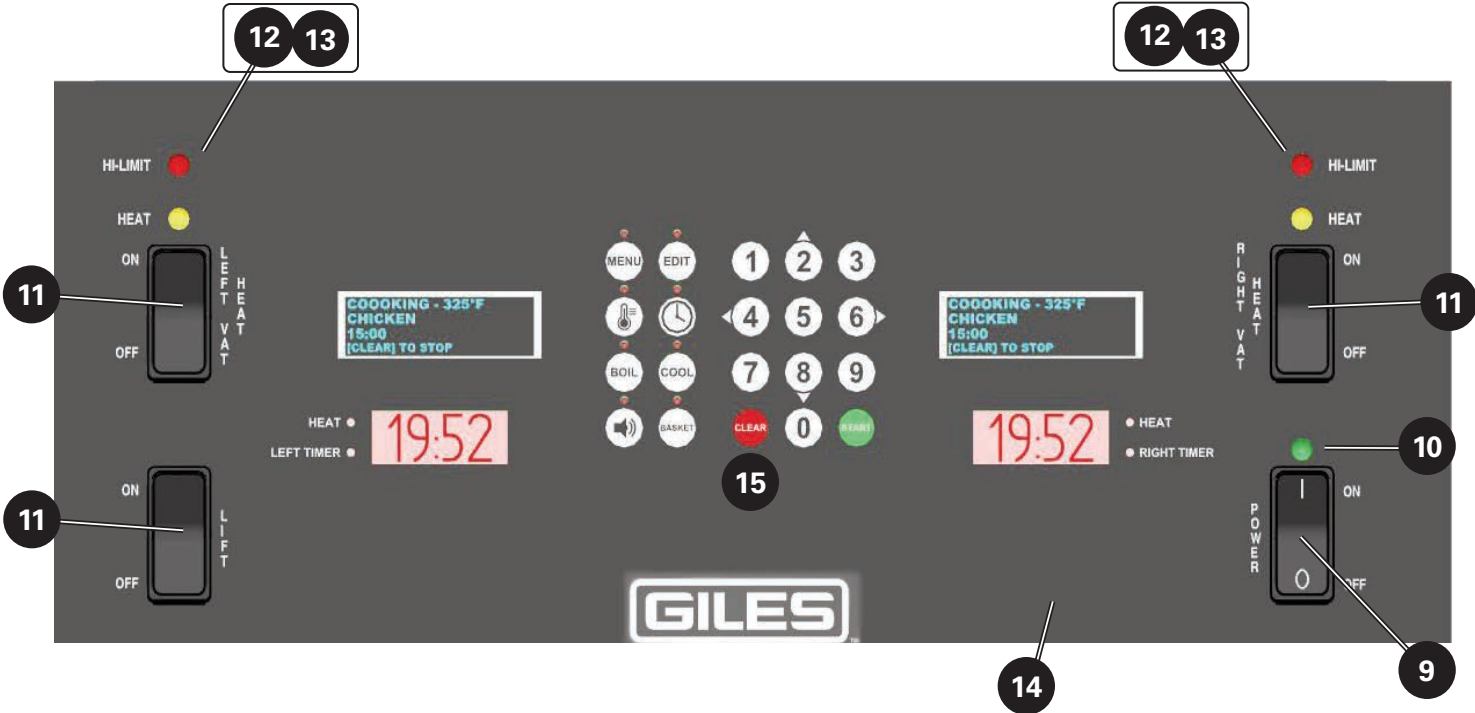
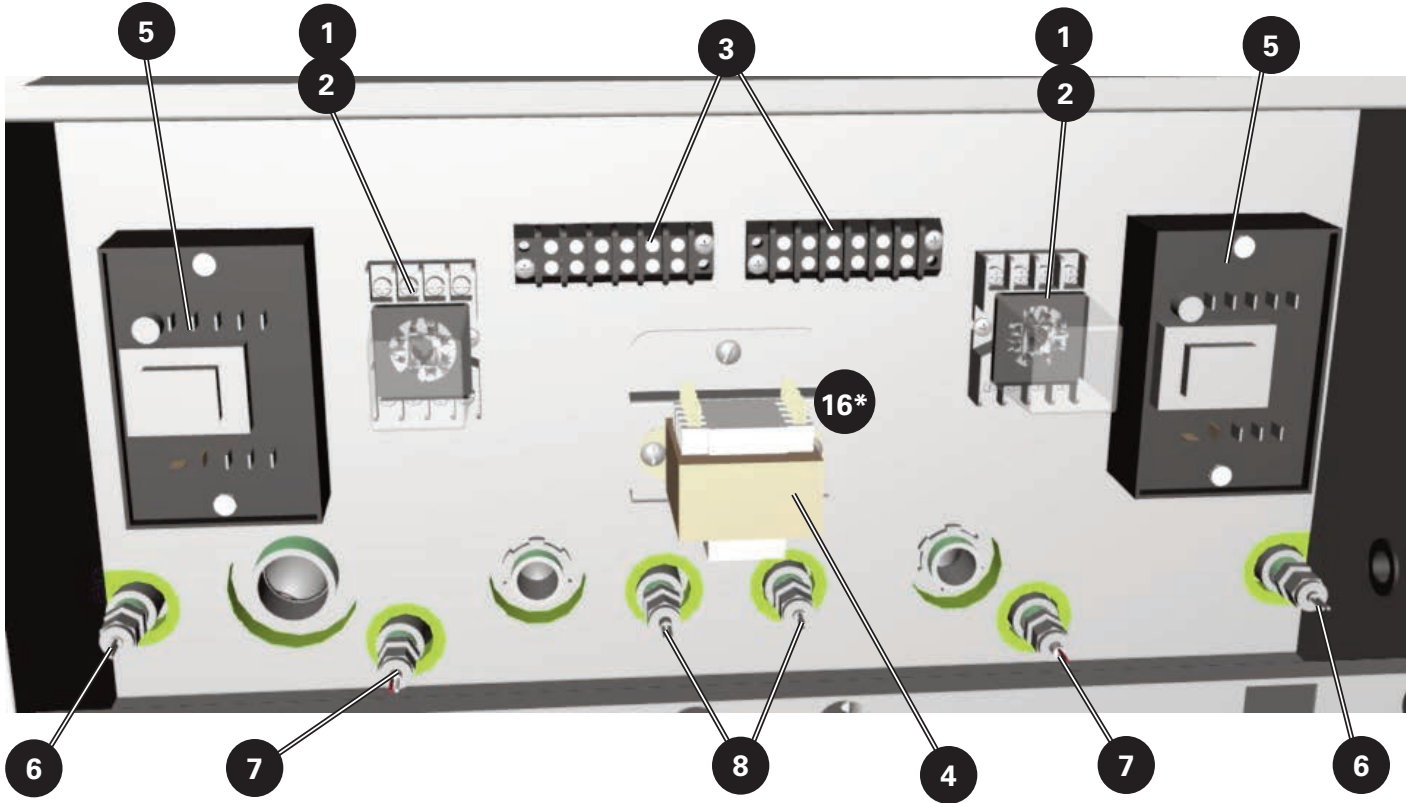

\* Not shown

## 8.4. EOF10-10 Front Header & Control Panel

Item	Part Number	Qty	Description
1	<a href="#">21101</a>	2	SOCKET, RELAY, 8 PIN, 300V, 10A
2	<a href="#">21102</a>	2	RELAY, 8 PIN, 240V, 10A
3	<a href="#">23751</a>	2	TERMINAL BLOCK, 6-POLE
4	<a href="#">20366</a>	1	TRANSFORMER, 20VA, 115/230V, 60HZ, CL2
5	<a href="#">23755</a>	2	THERMOSTAT, SAFETY, 450°F
6	<a href="#">20315</a>	2	THERMOCOUPLE, J-TYPE, 13.5, UNGROUNDED (Requires # <a href="#">45111</a> , FERRULE)
7	20362	2	THERMOCOUPLE, J-TYPE, 7.5, UNGROUNDED (Requires # <a href="#">45111</a> , FERRULE)
8	20365	2	THERMOCOUPLE, J-TYPE, 12", GROUNDED (Requires # <a href="#">45111</a> , FERRULE)
9	<a href="#">21190</a>	1	SWITCH, ROCKER, D.P.S.T. 250V, 10A
10	<a href="#">20398</a>	1	INDICATOR LIGHT, GREEN, 250V, 0.5W
11	<a href="#">21052</a>	2 or 3	SWITCH, ROCKER, D.P.D.T. 250V, 10A
12	<a href="#">20399</a>	2	INDICATOR LIGHT, AMBER, 250V, 0.5W
13	<a href="#">20402</a>	2	INDICATOR LIGHT, RED, 250V, 0.5W
14	66129	1	LABEL, CONTROL PANEL, CC10, EOF10-10
15	<a href="#">21380</a>	1	CONTROLLER, CC10, DUAL DISPLAY, EOF10-10
16*	<a href="#">38365</a>	1	FUSE ASSEMBLY, 1A, CONTROLLER POWER TRANSFORMER

\* Not shown

8.5. EOF10-10 Front Lower Cabinet

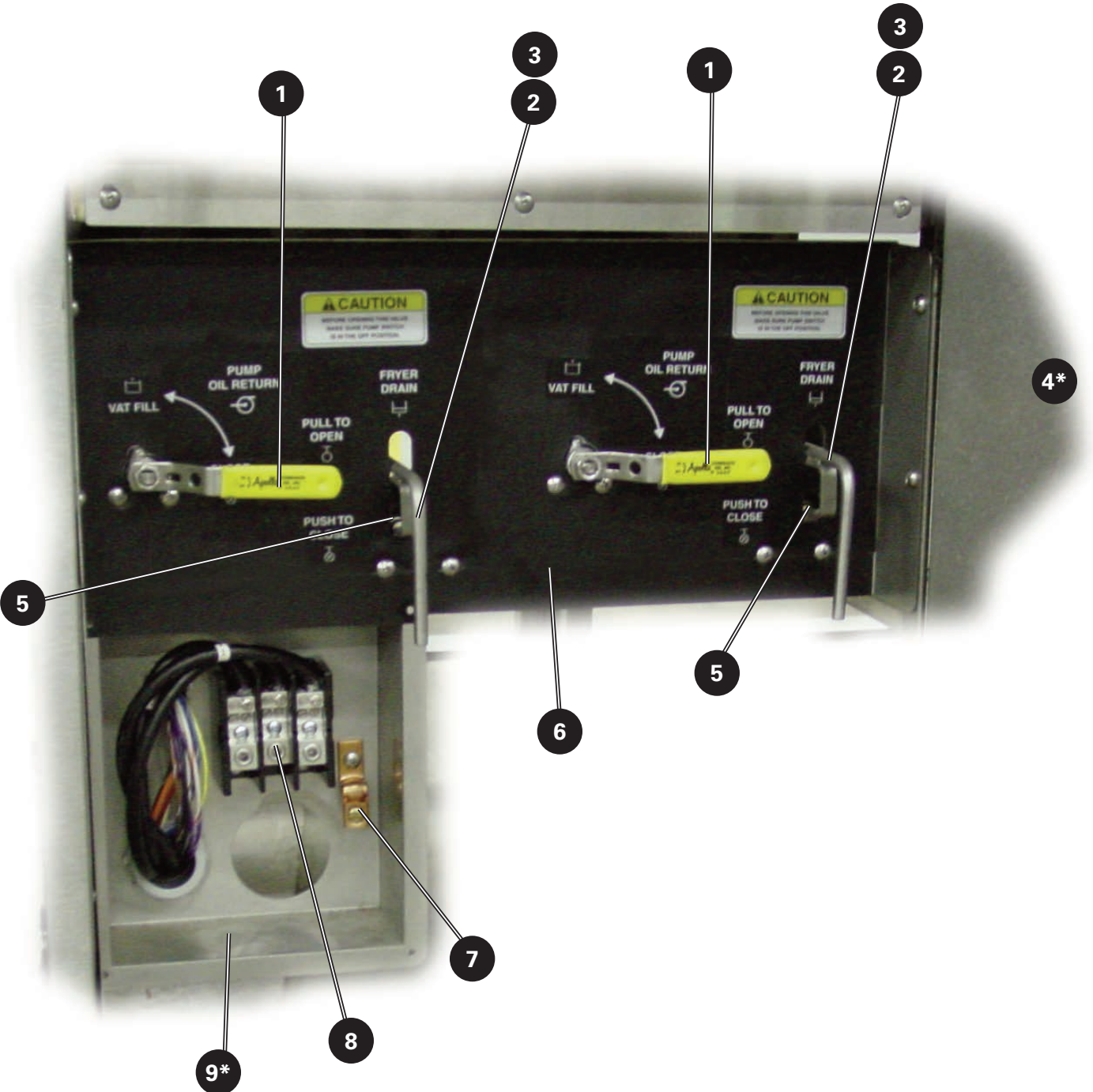

\* Not shown

## 8.5. EOF10-10 Front Lower Cabinet

Item	Part Number	Qty	Description
1	<a href="#">40784</a>	2	VALVE, BALL, 1/2-IN, S/S W/NONSTICK SEALS
2	<a href="#">39258</a>	2	DRAIN PULL HANDLE
3	<a href="#">40818</a>	2	VALVE, BALL,1-1/4, DRAIN, SGL.THREAD END
4*	<a href="#">35151</a>	1	DOOR ASSEMBLY (WITHOUT PLASTIC HANDLE)
5	<a href="#">21157</a>	2	LIMIT SWITCH, DRAIN, 15A, 250V
6	63986	1	LABEL, FRONT BRACE, EOF10-10 UNIT
7	21051	1	GROUND LUG, 1/0-2/0, 125A, 1/4" HOLE
8	<a href="#">21164</a>	1	POWER DISTRIBUTION BLOCK
9	<a href="#">39978</a>	1	COVER, SERVICE CONNECTION BOX

\* Not shown

8.6. EOF10-10 Rear Upper & Lower Cabinet

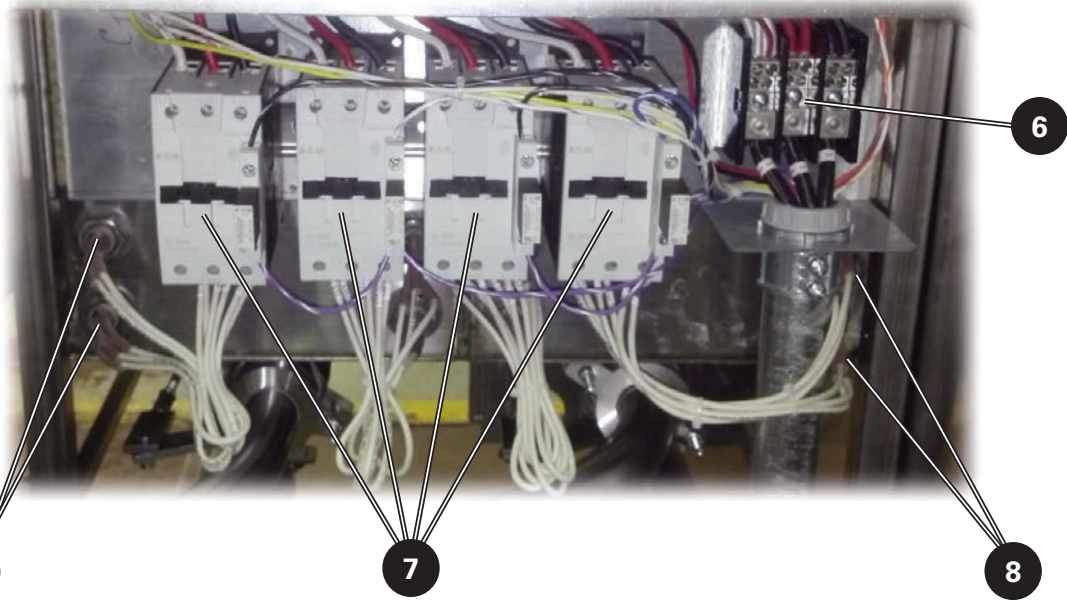
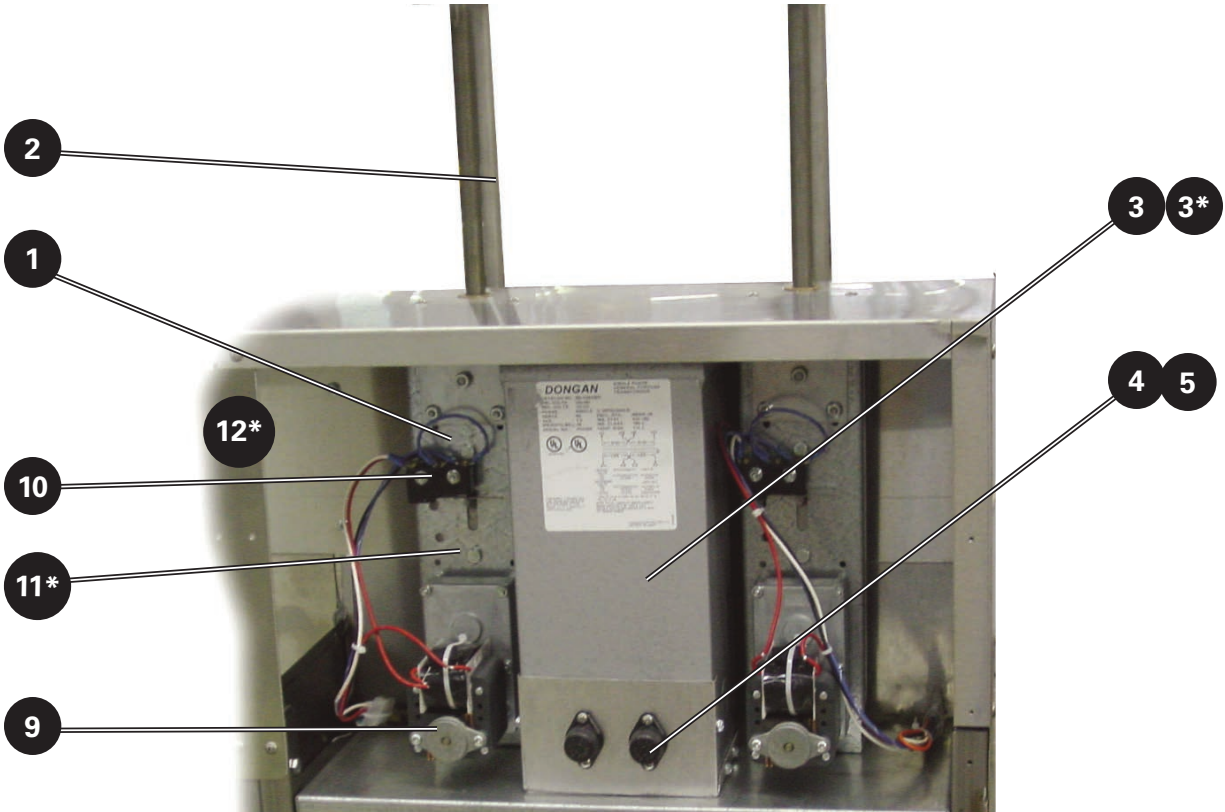

\* Not shown

## 8.6. EOF10-10 Rear Upper & Lower Cabinet

Item	Part Number	Qty	Description
1	<a href="#">35166</a>	2	BASKET LIFT ASSEMBLY (COMPLETE W/MOTOR)
2	<a href="#">39403</a>	2	BASKET CARRIER ASSEMBLY (COMPLETE)
3	<a href="#">24277</a>	1	TRANSFORMER, 480V TO 240V, 1.5 KVA <b>(480V UNIT, TRANSFORMER ONLY)</b>
3*	<a href="#">20513</a>	2	CIRCUIT BREAKER, 50A, 6-POLE <b>(208V UNIT, BREAKERS ONLY)</b>
4	<a href="#">21950</a>	2	FUSE HOLDER, 300V, 15A, SC-0 TO 15
5	<a href="#">21900</a>	2	FUSE, 15A, SC-15
6	<a href="#">21164</a>	1	TERMINAL BLOCK, POWER DISTRIBUTION
7	<a href="#">21245</a>	4	CONTACTOR, 60A, 3-POLE, MULTI-VOLT COIL
8	<a href="#">20359</a>	4	ELEMENT, 6000W, 480V, FIREBAR
8	<a href="#">20357</a>	4	ELEMENT, 6000W, 208V, FIREBAR
9	<a href="#">36457</a>	2	BASKET LIFT MOTOR ASSEMBLY <b>(MOTOR W/QUENCHARC ONLY, INCLUDED WITH ITEM #1)</b>
10	22787	2	SWITCH, DOUBLE SNAP ACTION, 250V, 10A <b>(INCLUDED WITH ITEM #1)</b>
11*	<a href="#">30921</a>	2	CHAIN ASSEMBLY <b>(INCLUDED WITH ITEM #1)</b>
12*	<a href="#">34971</a>	1	BACK CABINET PANEL

\* Not shown

8.7. EOF-20 Front Lower Cabinet

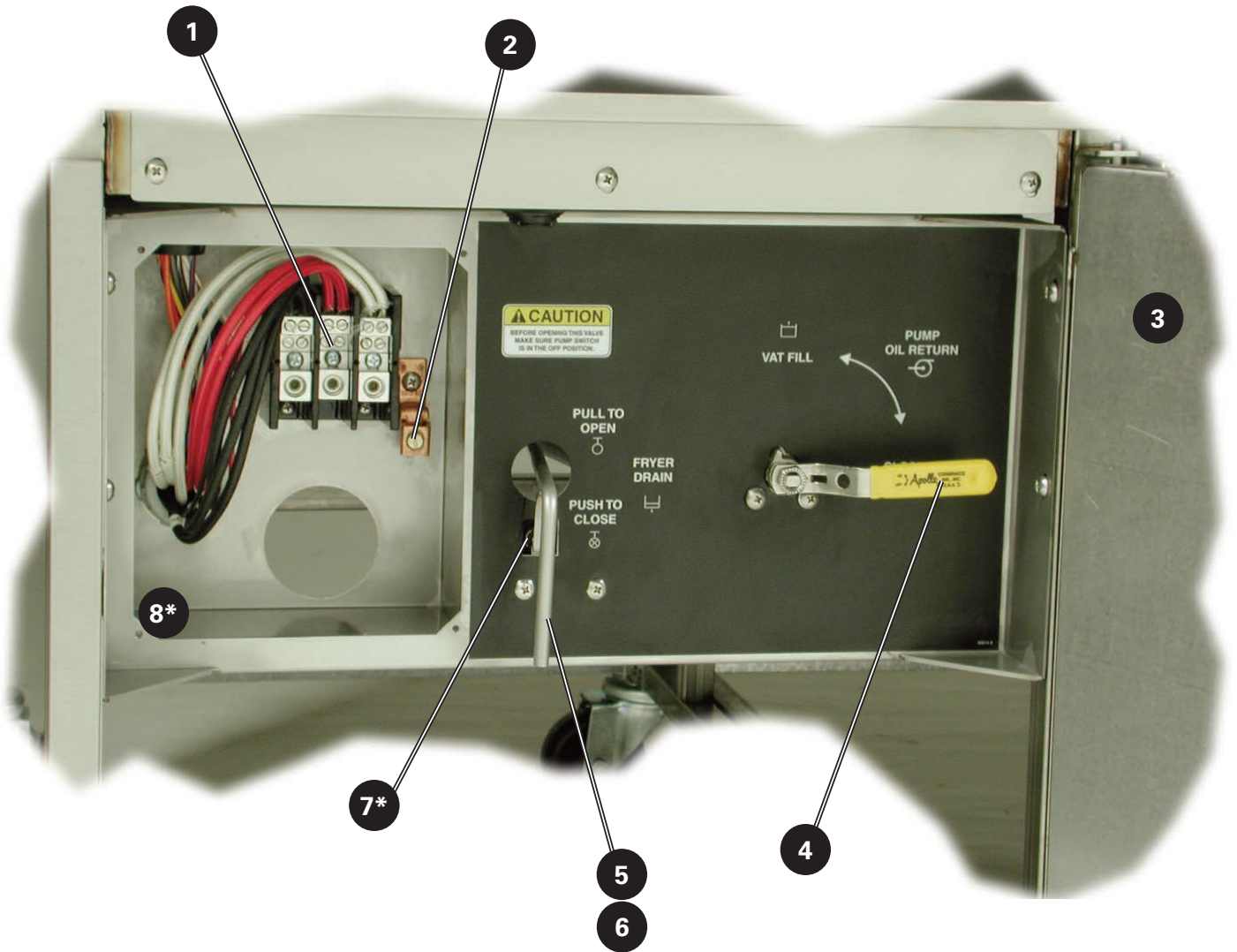

\* Not shown

## 8.7. EOF-20 Front Lower Cabinet

Item	Part Number	Qty	Description
1	<a href="#">21164</a>	1	POWER DISTRIBUTION BLOCK
2	21051	1	GROUND LUG, 1/0-2/0, 125A, 1/4" HOLE
3	<a href="#">35151</a>	1	DOOR ASSEMBLY (WITHOUT PLASTIC HANDLE)
4	<a href="#">40784</a>	1	VALVE, BALL, 1/2-IN, S/S W/NONSTICK SEALS
5	<a href="#">39258</a>	1	DRAIN PULL HANDLE
6	<a href="#">40818</a>	1	VALVE, BALL,1-1/4, DRAIN, SGL.THREAD END
7*	<a href="#">21157</a>	1	LIMIT SWITCH, DRAIN, 15A, 250V
8*	<a href="#">35236</a>	1	COVER, SERVICE CONNECTION BOX, EOF-20/24

\* Not shown

8.8. EOF-20 Rear Lower Cabinet

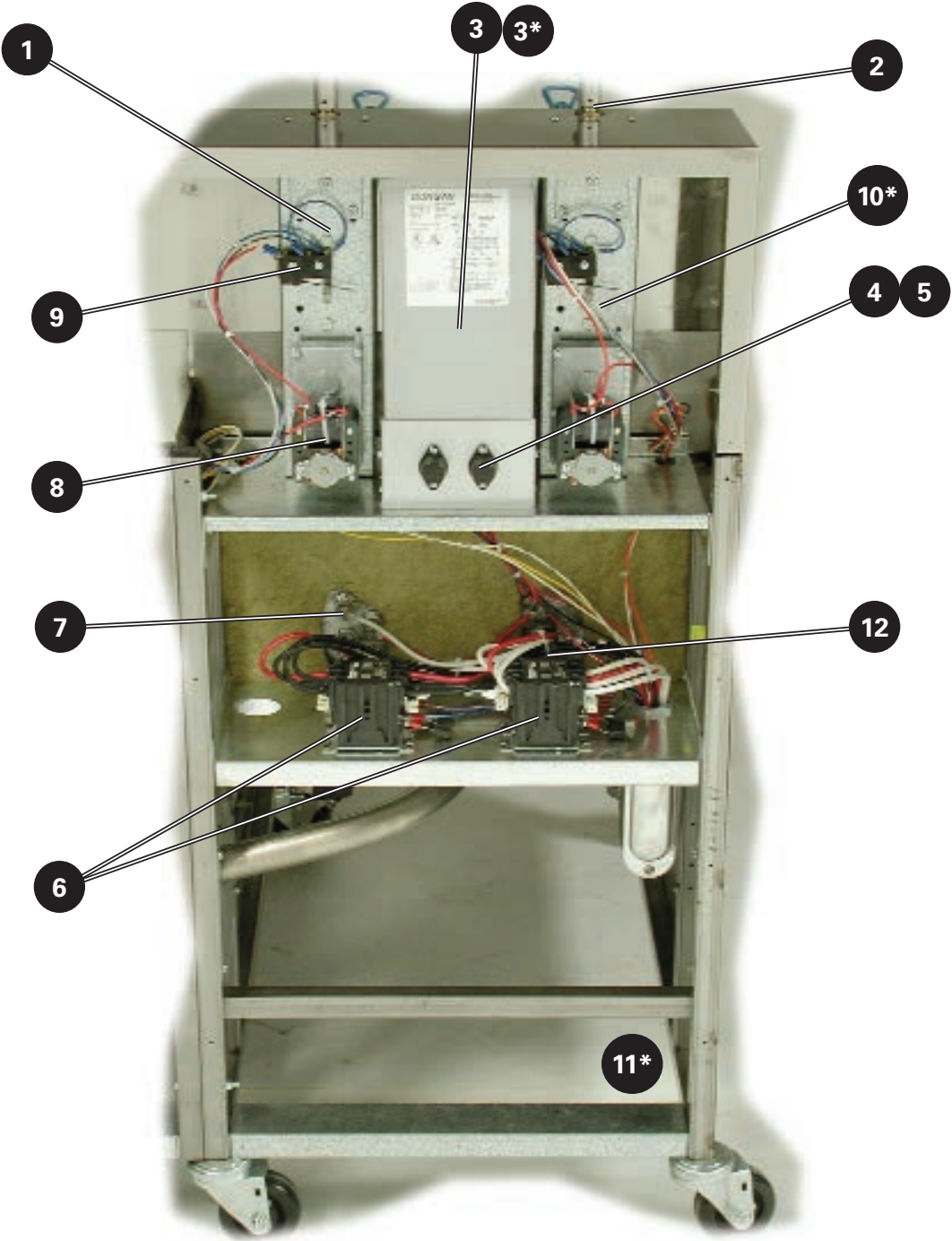

\* Not shown

## 8.8. EOF-20 Rear Lower Cabinet

Item	Part Number	Qty	Description
1	<a href="#">35166</a>	2	BASKET LIFT ASSEMBLY (COMPLETE W/MOTOR)
2	<a href="#">39403</a>	2	BASKET CARRIER ASSEMBLY (COMPLETE)
3	<a href="#">24277</a>	1	TRANSFORMER, 480V TO 240V, 1.5 KVA (480V UNIT, TRANSFORMER ONLY)
3*	<a href="#">20513</a>	2	CIRCUIT BREAKER, 50A, 6-POLE (208V UNIT, BREAKERS ONLY)
4	<a href="#">21950</a>	2	FUSE HOLDER, 300V, 15A, SC-0 TO 15
5	<a href="#">21900</a>	2	FUSE, 15A, SC-15
6	20624	2	CONTACTOR, 60A, 4-POLE, 240V COIL (480V UNIT, INCLUDES SUPPRESSOR)
6	<a href="#">21244</a>	2	CONTACTOR, 60A, 4-POLE, 208V COIL (208V UNIT, INCLUDES SUPPRESSOR)
7	<a href="#">24257</a>	4	ELEMENT, ROUND, 6000W, 480V, EOF-20
7	<a href="#">20003</a>	4	ELEMENT, ROUND, 6000W, 208V, EOF-20
8	<a href="#">36457</a>	2	BASKET LIFT MOTOR ASSEMBLY (MOTOR W/QUENCHARC ONLY, INCLUDED WITH ITEM #1)
9	22787	2	SWITCH, DOUBLE SNAP ACTION, 250V, 10A (INCLUDED WITH ITEM #1)
10*	<a href="#">30921</a>	2	CHAIN ASSEMBLY (INCLUDED WITH ITEM #1)
11*	<a href="#">34971</a>	1	BACK CABINET PANEL, EOF-20
12	<a href="#">21421</a>	2	RC SUPPRESSOR, 40A TO 65A (SUPPRESSOR ONLY, INCLUDED WITH ITEM #6)

\* Not shown

8.9. EOF-24 Front Lower Cabinet

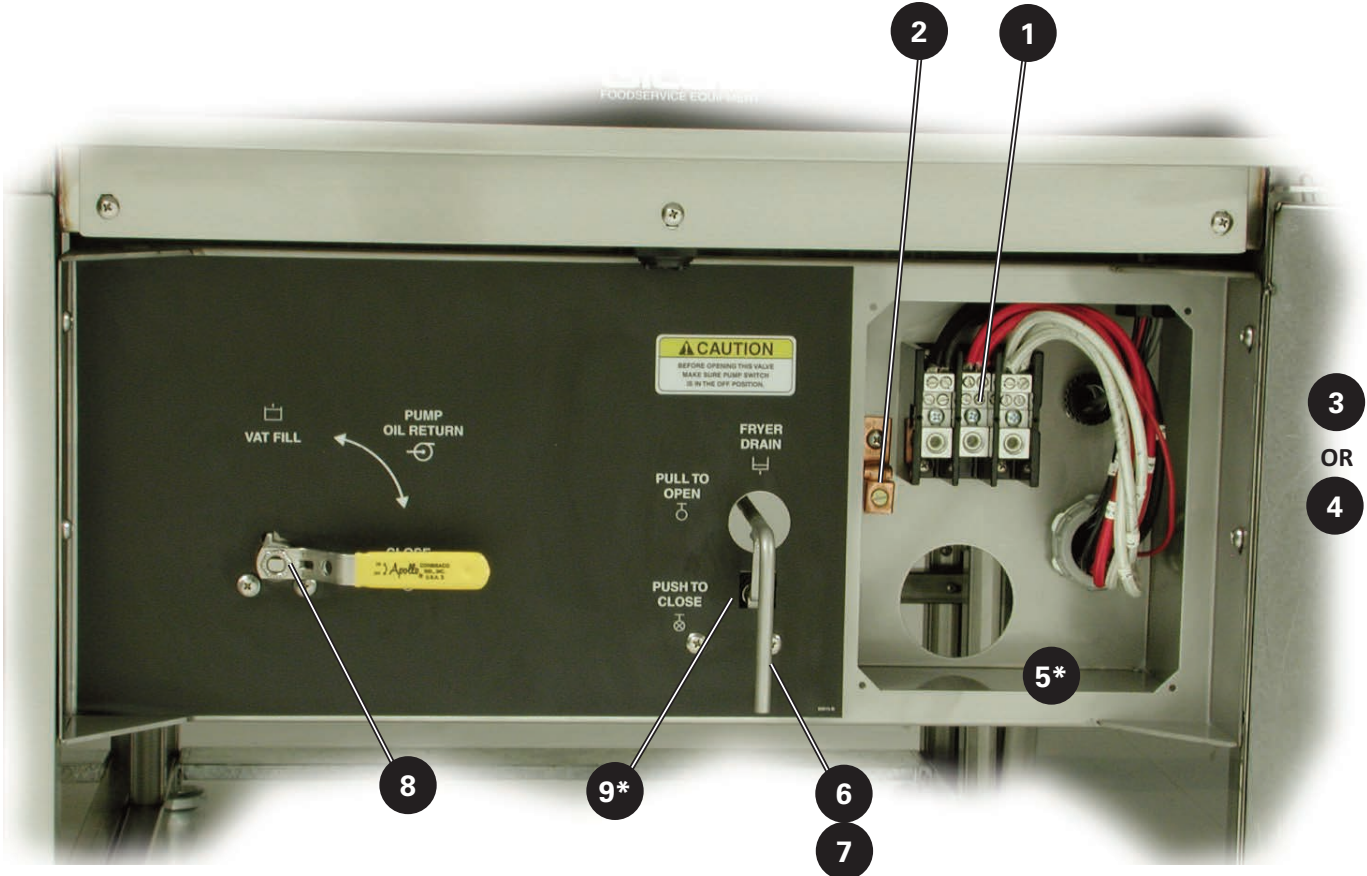

\* Not shown

## 8.9. EOF-24 Front Lower Cabinet

Item	Part Number	Qty	Description
1	<a href="#">21164</a>	1	POWER DISTRIBUTION BLOCK
2	21051	1	GROUND LUG, 1/0-2/0, 125A, 1/4" HOLE
3	<a href="#">35150</a>	1	DOOR ASSEMBLY, EOF-24 (WITHOUT PLASTIC HANDLE)
4	<a href="#">35152</a>	1	DOOR ASSEMBLY, EOF-24 (RIGHT-SIDE CABINET OF 3-FRYER UNIT, WITHOUT PLASTIC HANDLE)
5*	<a href="#">39258</a>	1	COVER, SERVICE CONNECTION BOX, EOF-20/24
6	<a href="#">40818</a>	1	VALVE, BALL, 1-1/4, DRAIN, SGL.THREAD END
7	<a href="#">39260</a>	1	DRAIN PULL HANDLE
8	<a href="#">40784</a>	1	VALVE, BALL, 1/2-IN, S/S W/NONSTICK SEALS
9*	<a href="#">21157</a>	1	LIMIT SWITCH, DRAIN, 15A, 250V

\* Not shown

8.10. EOF-24 Rear Lower Cabinet

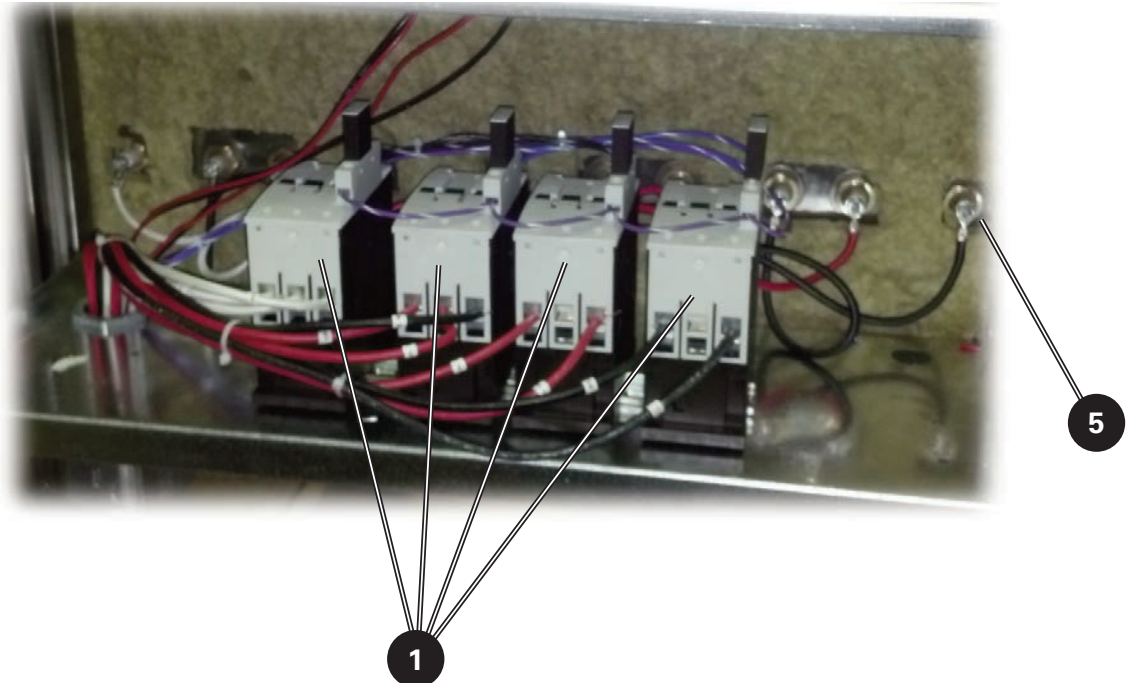
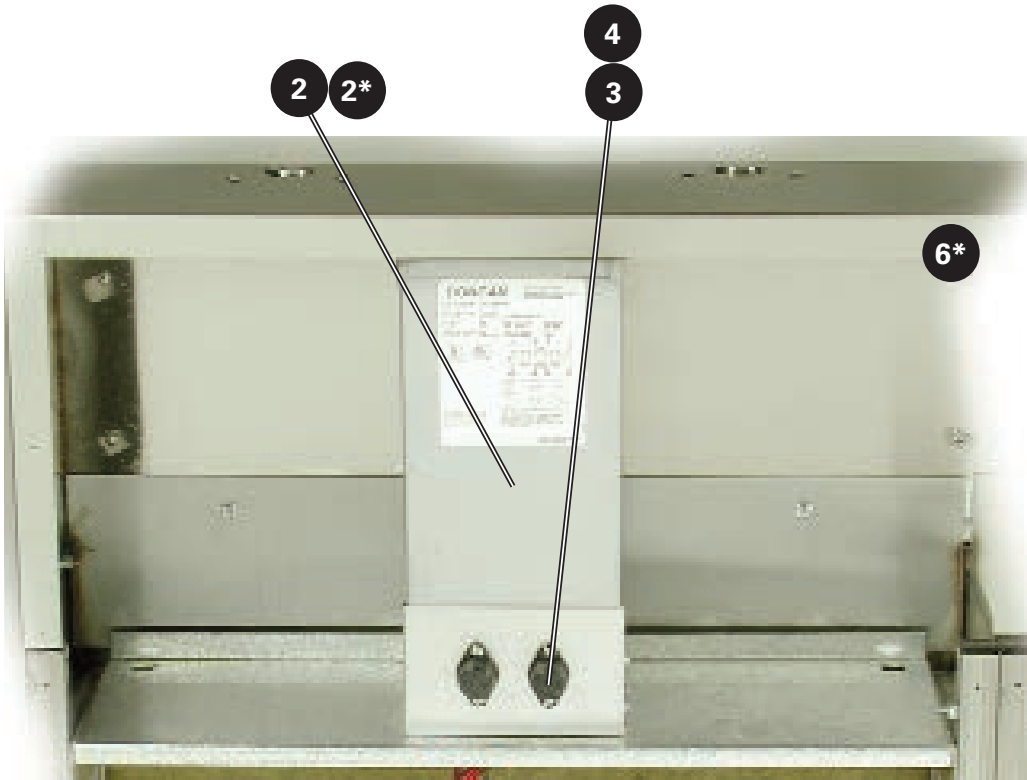

\* Not shown

## 8.10. EOF-24 Rear Lower Cabinet

Item	Part Number	Qty	Description
1	<a href="#">21245</a>	4	CONTACTOR, 60A, 3-POLE, MULTI-VOLT COIL
2	<a href="#">24277</a>	1	TRANSFORMER, 480V TO 240V, 1.5 KVA <b>(480V UNIT, TRANSFORMER ONLY)</b>
2*	<a href="#">20513</a>	2	CIRCUIT BREAKER, 50A, 6-POLE <b>(208V UNIT, BREAKERS ONLY)</b>
3	<a href="#">21950</a>	2	FUSE HOLDER, 300V, 15A, SC-0 TO 15
4	<a href="#">21900</a>	2	FUSE, 15A, SC-15
5	<a href="#">20005</a>	5	ELEMENT, ROUND, 6000W, 208V, EOF-24
5	<a href="#">24239</a>	5	ELEMENT, ROUND, 6000W, 480V, EOF-24
6*	<a href="#">34977</a>	1	BACK CABINET PANEL, EOF-24

\* Not shown

8.11. FFLT Cabinet Front

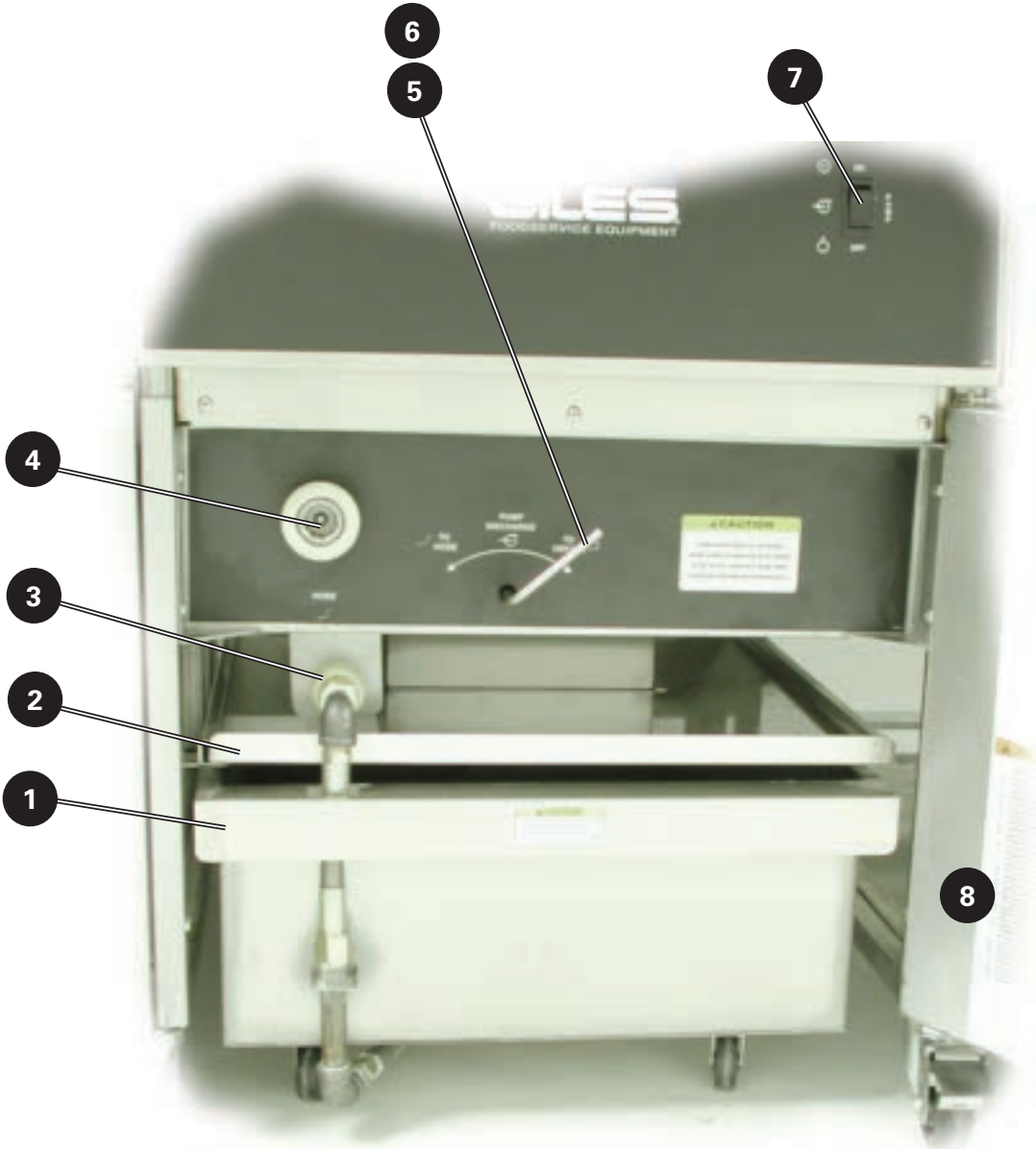

## 8.11. FFLT Cabinet Front

Item	Part Number	Qty	Description
1	<a href="#">35202</a>	1	FILTER PAN ASSEMBLY, EOF ( <b>COMPLETE</b> )
2	<a href="#">38994</a>	1	FILTER PAN COVER
3	<a href="#">41900</a>	1	COUPLING, QUICK-DISCONNECT, FEMALE, FILTER PAN CONNECTION
4	<a href="#">41699</a>	1	COUPLING, QUICK DISCONNECT, FEMALE, DISCHARGE HOSE CONNECTION
5	<a href="#">35108</a>	1	HANDLE, DIVERTER VALVE
6	<a href="#">45755</a>	1	VALVE, 3-WAY, 1/2 NPT, PLATED
7	<a href="#">21052</a>	1	SWITCH, ROCKER, D.P.D.T. 250V, 10A
8	<a href="#">35152</a>	1	DOOR ASSEMBLY, FFLT (WITHOUT PLASTIC HANDLE)

## 8.12. FFLT Cabinet Rear

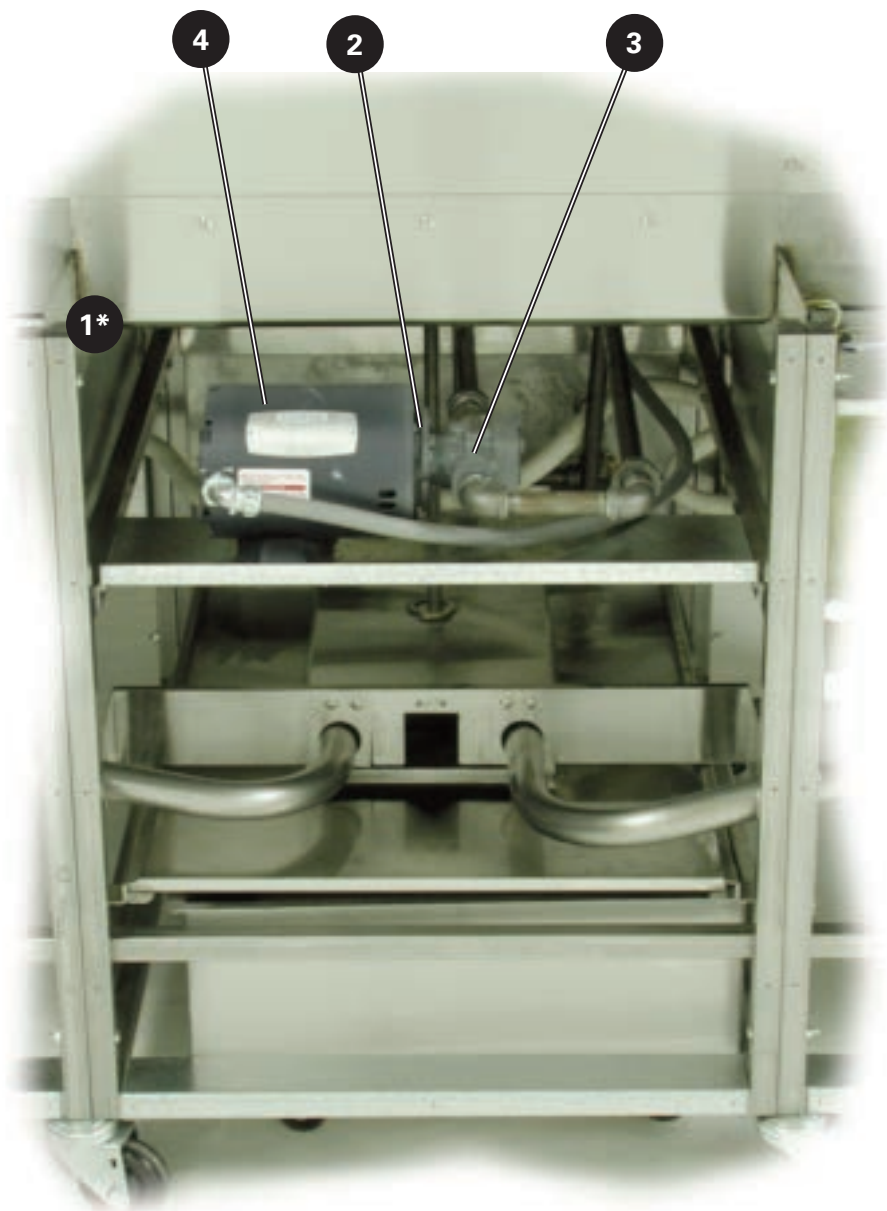

\* Not shown

## 8.12. FFLT Cabinet Rear

Item	Part Number	Qty	Description
1*	34970	1	CABINET BACK PANEL
2	71754	1	PUMP & MOTOR ASSY, 5-GPM, 1/2-HP
3	76923	1	PUMP HEAD ONLY, 5-GPM (INCLUDED W/ITEM #2)
4	71824	1	MOTOR ONLY, 1/2-HP (INCLUDED W/ITEM #2)

\* Not shown

8.13. Filter Pan

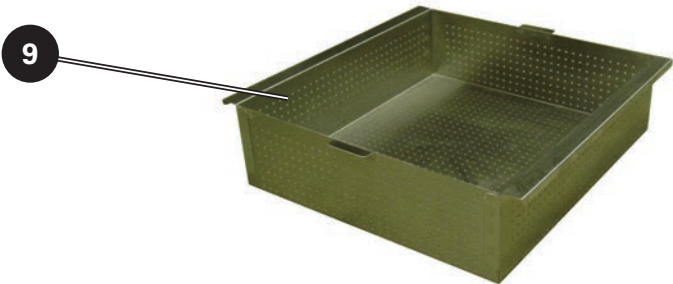
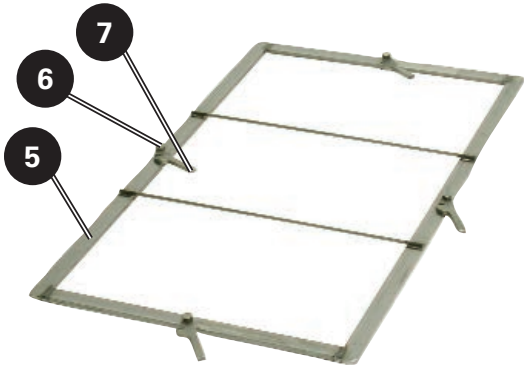

NOTE: FILTER MEDIA SUPPORT SCREEN IS NOT REMOVABLE

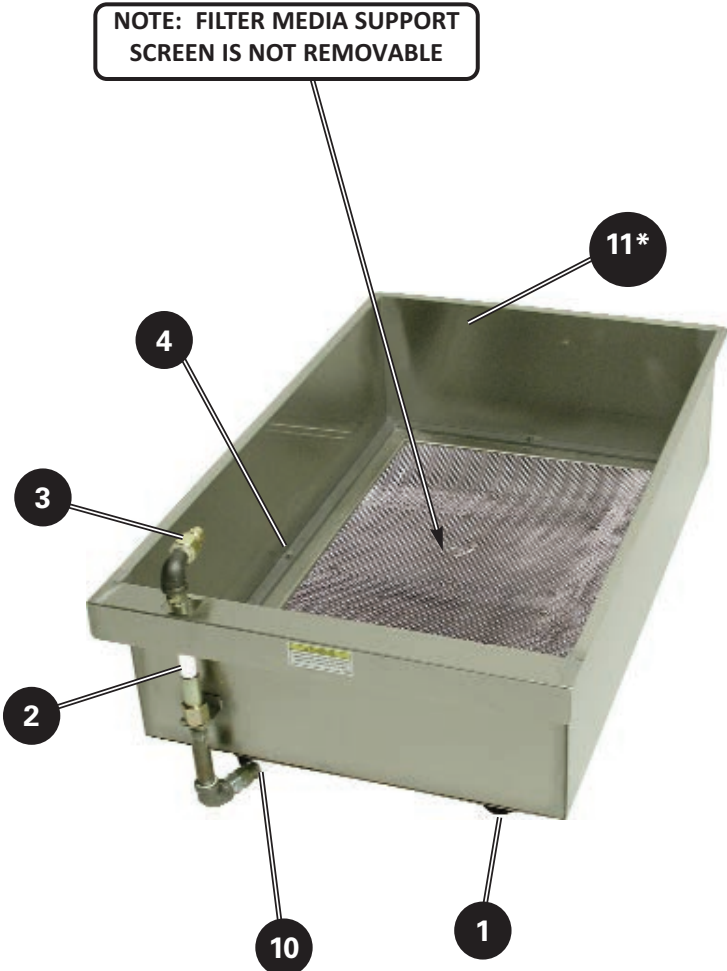
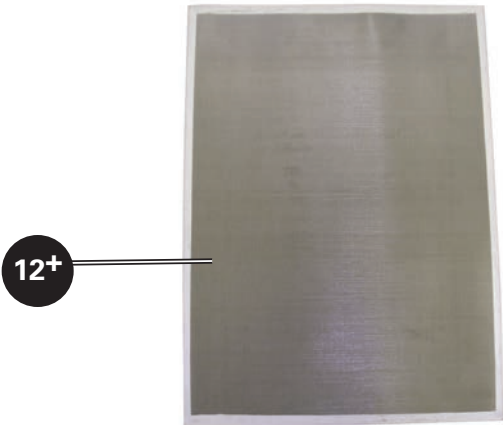
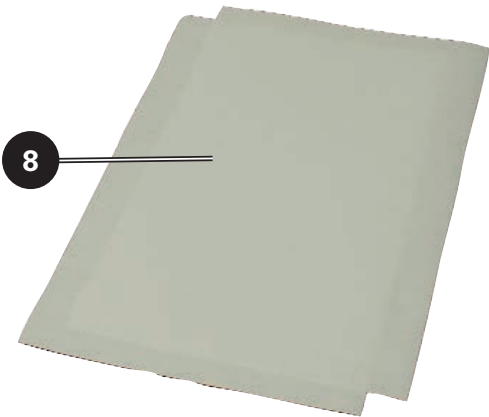

\* Complete assembly  
+ Optional Item; Purchased Separately

## 8.13. Filter Pan

Item	Part No.	Qty.	Description
1	40649	4	CASTER, LOW PROFILE, PLATE MOUNT
2	40959	1	HOSE, 1/2NPT X 7-5/8, SCT, 1-END SWIVEL
3	44150	1	FITTING, BRASS, MALE, 1/2NPT, QUICK-DISCONNECT
4	30039-8	4	STUD, FILTER PAN SUPPORT FRAME
5	36772	1	HOLD-DOWN FRAME
6	30040-4	4	STUD, FILTER PAN HOLD-DOWN FRAME
7	54526	4	LEVER, FILTER PAN HOLD-DOWN FRAME
8	60328	1	PAPER FILTER MEDIA, 19-3/8 X 32-3/8 (100 CT. CASE)
9	36212	1	CRUMB CATCHER SCREEN, FILTER PAN INSERT
10	40958	1	HOSE, 1/2NPT X 18, SCT, 1-END SWIVEL
11*	35202	1	FILTER PAN COMPLETE ASSEMBLY (#36212 Crumb Catcher not included)
12 <sup>+</sup>	41017	1	REUSABLE, RENEWABLE FILTER SCREEN, 19.375 X 32.375 (Optional Item)

\* Complete assembly

+ Optional Item; Purchased Separately



**Notes:**

---

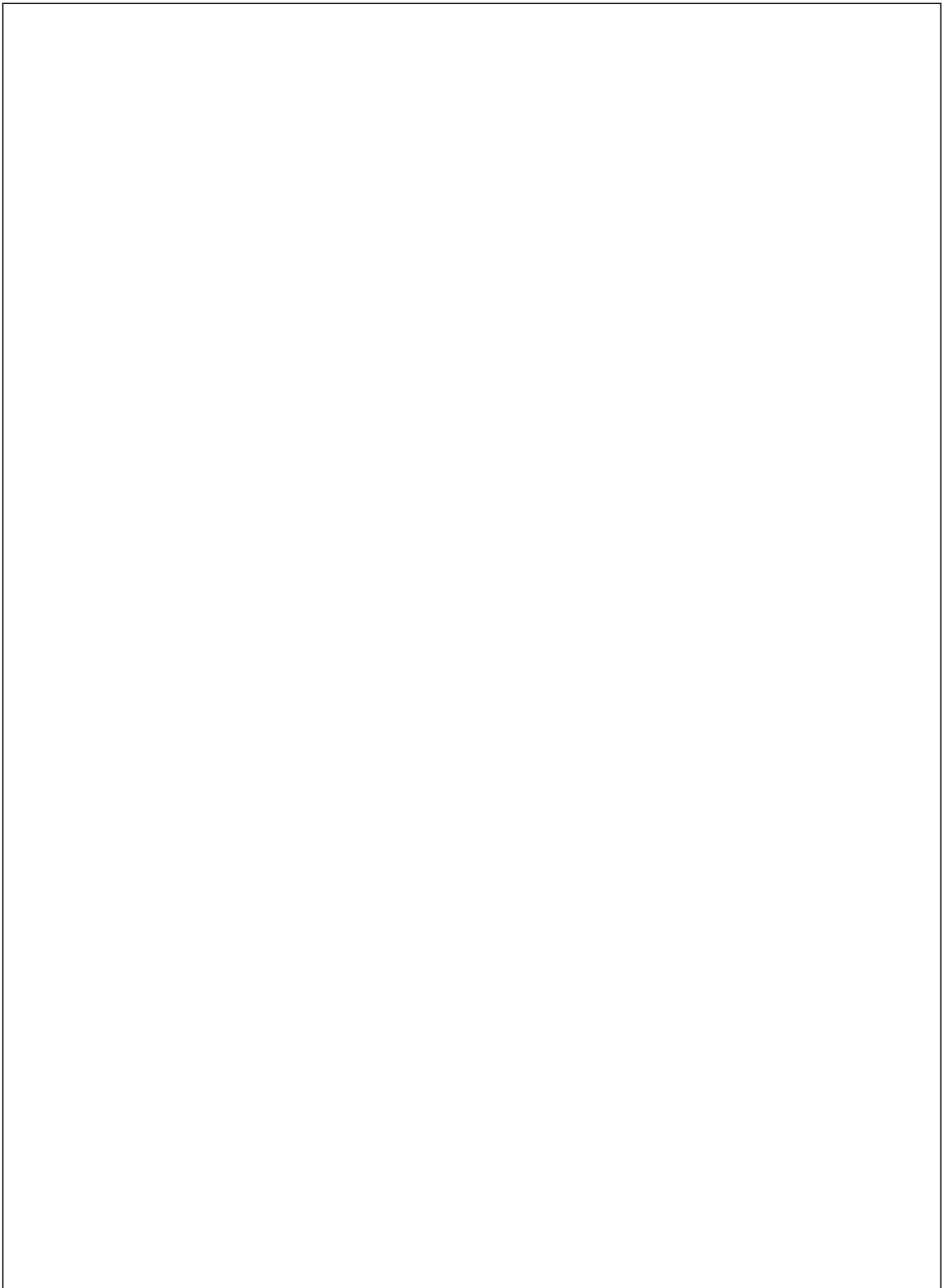



**Responsive. Reliable.**

2750 Gunter Park Drive West • Montgomery, AL 36109 USA  
334.272.1457 • Toll-free 800.554.4537 (USA & Canada Only) • FAX 334.239.4117 • [www.gfse.com](http://www.gfse.com) • e-mail: [services@gfse.com](mailto:services@gfse.com)

Form No. 60221 (Rel. Date: 11/1999; Rev. Date: Oct.2017, Rev. G)