

Operations & Service Manual

EOF10-10/20



ISO 9001-2015



Responsive. Reliable.

Giles Foodservice Equipment

2750 Gunter Park Drive West • Montgomery, AL 36109 USA

Phone: 334.272.1457 • Toll Free: 800.554.4537 (USA & Canada Only)

Fax: 334.239.4117 • Website: www.gfse.com • Email: services@gfse.com

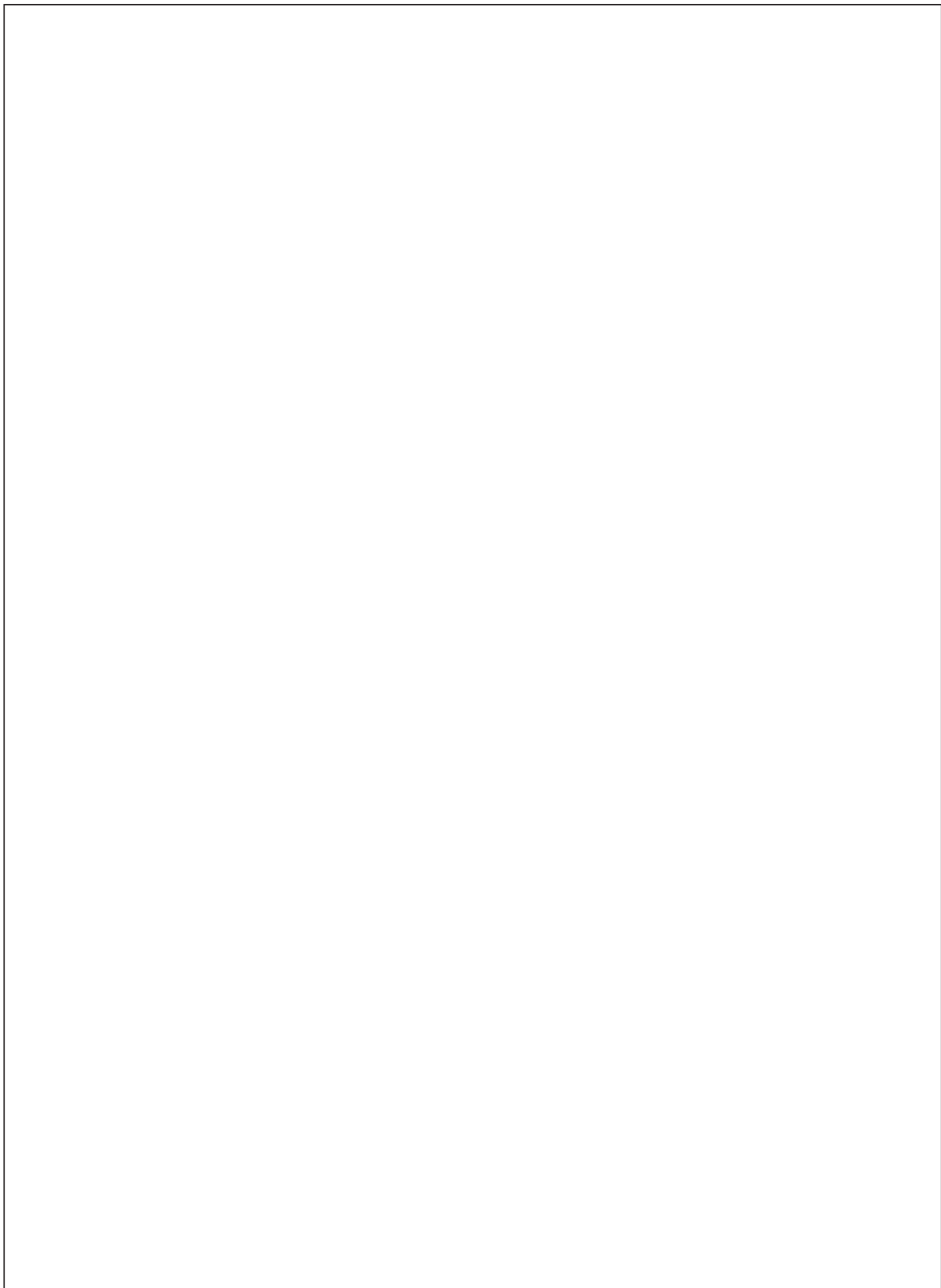

LIMITED WARRANTY

- Subject to the terms and conditions of this Limited Warranty as herein stated, all Giles Enterprises Inc. (hereafter referred to as “Giles”) foodservice equipment and parts purchased new from an authorized Giles representative are warranted as to defects in material or workmanship for a period of twenty-four (24) months from the date of installation, provided, however, that with regard to labor costs in connection with this warranty, see below. All installations must be made by a qualified installing agency in accordance with all applicable codes and/or regulations in the jurisdiction in which installed. Limited warranty coverage is extended only to the original owner and is void if the unit is resold.
- During the Limited Warranty period, Giles will replace or recondition, at its factory, any part or parts of this unit which Giles inspectors judge defective, provided the unit has been subjected to normal usage, properly installed, operated and maintained. This Limited Warranty does not cover cosmetic damage, and damage due to acts of God, accident, misuse, alteration, negligence, abuse of the equipment, or the use of unorthodox repair methods. All parts replaced under this Limited Warranty carry only the unexpired term of this Limited Warranty. Limited Warranty service may be furnished only by an authorized Giles service representative.
- If Limited Warranty service is requested, Giles will dispatch factory-authorized service representatives to inspect, repair, recondition, or replace units of its manufacture with such labor being rendered without cost to owner for twenty-four (24) months from the date of installation. Otherwise, service, including labor and transportation charges or other expenses, in connection with the removal or installation of any part or parts supplied under this Limited Warranty, are specified on the original sales contract between the purchaser and the authorized Giles representative.
- **Failure to use Giles OEM replacement parts and Giles OEM filters may void this Warranty.**
- Giles reserves the right to change or improve its equipment and/or parts in any way without obligation to alter such equipment or parts previously manufactured.
- Giles makes no further warranties, express or implied, including implied warranties of merchantability or fitness for a particular purpose, and has no other obligation or liability not specifically stated herein.
- Repair or replacement as provided under this limited warranty is the exclusive remedy. Giles shall not be liable for any incidental or consequential damages for breach of any express or implied warranty on this product, except to the extent prohibited by applicable law. Any implied warranty of merchantability or fitness for a particular purpose on this product is limited in duration to the duration of this limited warranty.
- Used Giles foodservice equipment or parts, or Giles foodservice equipment or parts not purchased from an authorized Giles representative, carry no warranties, express or implied.

Safety	vii
Safety Overview	vii
Specific Safety Precautions	viii
1. Introduction	1
1-01. Construction	1
1-02. Standard Features	1
1-03. Optional Features	1
1-04. Specifications	2
1-04.1. Overall Dimensions	2
1-04.2. Regulatory Listings	3
1-04.3. Basket Size	3
1-04.4. Vat Size and Capacity	3
1-04.5. Shipping Specifications (Crated)	3
2. Installation	5
2-01. Location	5
2-02. Unpacking	6
2-03. Electrical Requirements	7
2-03.1. Electrical Specifications	7
2-04. Electrical Connections	7
2-04.1. Electrical Connections Diagram	8
2-05. Ventilation of Fryer	9
3. Overview	11
3-01. Basket Lifts & Baskets	12
3-02. EOF-20 Basket Hanger & Baskets	14
3-03. EOF10-10 Control Panel (Dual Display)	16
3-04. EOF-20 Control Panel	18
3-05. EOF10-10 Lower Cabinet (Left-Side)	20
3-06. EOF-20 Lower Cabinet (Right-Side)	22
3-07. Filter Pan Assembly	24
3-08. Accessories Included	26
3-09. Accessories Not Included	29
4. Installation Checkout & Preparation	31
4-01. Fryer Settings Before Each Test	31
4-02. Power Test	33
4-03. Heating Element Test	34
4-04. Filter Pump Test	35
4-05. Perform Boil Out Procedure	36
4-06. Initial Cleaning Before Cooking	36

5.	Fryer Operation	37
5-01.	Computer Controller	38
5-01.1.	Keys & Functions	38
5-01.2.	Controller General Operation	40
5-01.3.	Setting the Cooking Temperature, EOF-20 Single Display	41
5-01.3.1	Manually Setting the Cooking Temperature, EOF10-10 Dual Display	42
5-01.4.	Manually Setting a Cook Time	43
5-01.4.1	Manually Setting a Cook Time, EOF-20 Single Display	43
5-01.4.2	Manually Setting a Cook Time, EOF10-10 Dual Display	44
5-01.5	Working with Menus	45
5-01.5.1	Selecting a Menu Preset for Cooking	46
5-01.5.2	Editing a Menu Preset	48
5-01.6.	Cooking Cycle, General Overview	51
5-01.7.	Other Controller Functions	53
5-01.7.1	Manally Operating Basket Lifts (If Equipped)	53
5-01.7.2	COOL Mode	54
5-01.7.3	AUTO-COOL Feature	55
5-01.7.4	BOILOUT Mode	55
5-01.8.	User Settings, Access & Edit	56
5-01.9	PASSWORD Protection	57
5-01.10	Power Up Procedure	57
5-01.11	Controller Errors & Alarms	58
5-01.11.1	Resolving Controller Errors & Alarms	59
5-02.	Cooking Procedure	60
5-03.	Filtering Used Cooking Oil	65
5-04.	Removal of Waste Cooking Oil from Fryer	68
5-05.	Using Optional Stainless Filter Media Screen	71
5-05.1	Cleaning Optional Stainless Filter Media Screen	71
5-05.	Normal Shut-Down	72
5-06.	Emergency Shut-Down	72
6.	Cleaning	75
6-01.	Boil-Out Procedure (Cleaning a Fry Vat)	75
6-02.	Cleaning the Filter Pan & Renewing Filter Media	78
7.	Troubleshooting	83
7-01.	Temperature Control System	83
7-02.	Oil Filtration System	85
7-03.	Basket Elevator System (Basket Elevator Option Only)	86
8.	Parts List	87
8-01.	Parts Ordering and Service Information	87
8-02.	EOF-20 Front Header & Control Panel (Right-Side)	88
8-03.	EOF10-10 Front Header & Control Panel (Left-Side)	90
8-04.	EOF10-10 Front Lower Cabinet (Left-Side)	92

Table Of Contents

EOF 10-10/20



8-05.	EOF-20 Front Lower Cabinet (Right-Side).....	94
8-06.	Cook Vats.....	96
8-07.	Rear Cabinet.....	98
8-08.	Filter Pan.....	100



Notes:

Safety

Safety Overview

The instructions contained in this manual have been prepared to aid you in learning the proper procedures for installing, operating and servicing your new **Giles Model EOF Series Electric Fryers**.

Throughout this manual, safety precautions are identified through the use of the safety alert symbol and three signal words: **DANGER**, **WARNING** and **CAUTION**. All safety alert information precedes the tasks to which they apply. Suggested, recommended, or other noteworthy information is identified through the use of **NOTES**, or be noted as **IMPORTANT!**. Additionally, certain words are used to indicate a specific meaning or to add emphasis as follows:

- Shall:** understood to be mandatory.
- Should:** understood to be advisory.
- May:** understood to be permissive.
- Will:** indicates a future event or condition to occur.

 **Hazard Alert Symbols** are used in conjunction with key words **DANGER**, **WARNING**, and **CAUTION** to alert user to potential personal injury hazards and/or poor operating practices. These will immediately precede precautionary measures pertaining to such hazards or practices. Adhere to all safety messages which follow these symbols to avoid possible injury, or even death. Failure to do so may also void the factory warranty.

DANGER

- Indicates an imminently hazardous situation which, if not avoided, will result in serious personal injury, even death.

WARNING

- Indicates a potentially hazardous situation which, if not avoided, could result in serious injury, even death.

CAUTION

- Indicates a potentially hazardous situation which, if not avoided, may result in minor to moderate injury. This notification is also used as an alert to unsafe practices.

CAUTION

- If used without the safety alert symbol, indicates a potentially hazardous situation which, if not avoided, may result in equipment and/or property damage, and may void the factory warranty.

NOTE or IMPORTANT!

- Identifies suggested, recommended, or other important information.

Specific Safety Precautions

For your safety, please observe the following precautions when operating or servicing **Model EOF Electric Fryers**. Adhering to the following important safety information will help to prevent personal injury and/or damage to the equipment.

⚠ DANGER

- Before cleaning or performing maintenance, place power switch of Fryer units in the **OFF** position. Unplug power cord or turn **OFF** power at the electrical panel supplying power to remove all power from the appliance.
- **DO NOT** wash down the Fryer interior or exterior with water from a spray hose.
- Failure to comply with **DANGER** notices will result in serious injury, even death; or damage to equipment and/or property and may void the factory warranty.

⚠ WARNING

- Prior to installation, consult a qualified electrician to ensure that installation will comply with all electrical requirements and codes.
- **The unit must be adequately and properly grounded. Improper grounding may result in electrical shock to the user. Always refer to local electrical code to ensure proper grounding of this or any other electrical equipment.**
- **Check the rating label on each of the units to determine the proper power supply required. Always consult with an electrician, or other qualified service technician, to ensure that circuit breakers and wiring are of sufficient rating and gauge to power this equipment. A Wiring Diagram has been provided with the unit as an aid for technicians. The unit must be installed and electrically grounded in accordance with local codes, or in the absence of local codes, in accordance with the National Electrical Code, NFPA 70.**
- Improper installation, adjustment, alteration, service or maintenance could result in serious injury, even death; equipment and/or property damage; and will potentially void the factory warranty.
- **DO NOT** use or store flammable liquids, or materials that produce flammable vapors, in the vicinity of this or any other appliance!
- **DO NOT for any reason stand or step onto the top of the appliance, and DO NOT allow other persons to do the same.** Cooking oil in the Fryer(s) can be in excess of **330°F (166°C)** and bodily contact will cause extremely serious injury. Covers used to sometimes cover cooking vats/pots are not designed to, and **WILL NOT**, support the weight of a person. 
- Failure to comply with **WARNING** notices could result in serious injury, even death; damage to equipment and/or property; and will potentially void the factory warranty.

CAUTION

- The appliance must remain in an upright (vertical) position.
- Exercise care when removing wooden crate framework and the unit from shipping pallet.
- **DO NOT** operate the appliance, unless its components and their intended functions are fully understood (see **Section 3**). Once you have read and fully understand **Section 3**, closely follow the instructions presented in this Operations Manual in order to prevent equipment damage, or malfunction.
- Parts of the Fryer become very **HOT** during operation! Temperatures inside the cabinet may exceed 150°F (65.5°C). Exercise caution during operation, when loading/unloading food products, and when cleaning and servicing. It is recommended that thermal protective gear (gloves or mitts) be worn while attended the appliance to avoid personal injury.
- Introducing foods containing excessive moisture, or attempting to load larger than recommended batch sizes, into the cook vat can cause a “surge boil” and result in an overflow of **HOT** cooking oil. Exercise due care when loading food and observe how the hot oil is reacting before continuing.
- Before operation, be sure the Fryer is positioned in a stable, safe location with the casters in the locked position. Some jurisdictions may require special anchoring for this type appliance; check local code.
- Allow the appliance to cool down at least 15-20 minutes before cleaning or servicing.
- This appliance is not intended for use by persons (including children) with reduced physical, sensory, or mental capabilities, or lack of experience and knowledge, unless they have been given adequate instruction and/or supervision concerning its use by a person responsible for their safety. Children should not be allowed to play with, or around, this appliance.
- Prior to sale, cooked food products must be maintained at a minimum temperature of 150°F (65.5°C), or in accordance with governing health regulations.
- Failure to comply with **CAUTION** notices may result in minor to moderate personal injury, damage to equipment or property, and potentially void the warranty.

CAUTION

- Components exposed on the Control Panel surface are impact-sensitive. To avoid damage and maintain proper operation, exercise care when working around, or using rolling carts or tables, near the appliance.
- **DO NOT** install the unit near combustible walls and materials. Failure to maintain safe distance may result in fire.
- When cleaning the appliance:
 - **DO NOT** steam clean.
 - **DO NOT** use products containing chlorine, or other corrosive chemicals.
 - **DO NOT** use abrasive products, steel wool or scouring pads.
 - **DO NOT** use oven cleaners.
- **DO NOT** alter, add attachments, or otherwise modify this equipment!
- Failure to comply with **CAUTION** notices may result in damage to equipment or property, and void the factory warranty.

NOTE:

- If upon receipt, the palletized unit showed any signs of damage, you should immediately inspect the appliance and associated accessories, and notify the freight carrier of any and all damages.
- Users must comply with all appropriate state and/or local health regulations regarding foodservice operations, and cleaning and sanitization of foodservice equipment.
- To ensure compliance with applicable building, health and fire codes, it is advisable that this appliance be installed by a professional kitchen equipment contactor, or service company. All costs for installation, including materials, labor and fees, are the responsibility of the customer.

1. Introduction

Thank you for purchasing a new Giles **EOF 10-10/20 FRYER** manufactured by Giles Enterprises, Inc., Montgomery, Alabama (USA), hereafter referred to as "Giles". Every unit is thoroughly inspected and tested prior to shipment, and with proper care and maintenance, will provide years of trouble-free service.

To help protect your investment in this state-of-the-art cooking equipment, we recommend taking a few moments to become familiar with the procedures in this Operations Manual, pertaining to installation, operation, cleaning and maintenance. Adhering to these recommended procedures minimizes potential for costly downtime and equipment repairs.

Please retain this Manual for future reference.

NOTE: Due to continuing improvements and product enhancements, some of the illustrations shown in this manual might not exactly depict current models.

1-01. Construction

The unit is constructed primarily of Series 430 Stainless Steel, with a welded tubular stainless steel frame.

1-02. Standard Features

Computer Controller: Controls cooking oil temperature and cook time, and all other operations. Features separate cook timers for each basket; fifty (50) editable menu item cooking presets. Monitors status; displays warnings, alarms and operational prompts. Features BOIL OUT program, COOL MODE, FORCE FILTER function and enhanced safeguards against accidental cooking oil fire. Provides a smooth operator interface.

Built-in Oil Filtration System: Completely self-contained; helps to extend the life of cooking oil. Designed to perform a filter cycle within approximately five (5) minutes; single system serves each vat.

EOF10-10 Split Vat: Single fryer unit with a split cooking vat, providing two (2) completely separate 10" vats for cooking different food types, such as poultry and seafood, without flavor cross-over.

1-03. Optional Features

Automatic Basket Lift: Automatically lowers uncooked product into oil at cycle start and lifts cooked product from hot cooking oil at the end of the programmed cooking cycle.

1-04. Specifications

1-04.1. Overall Dimensions

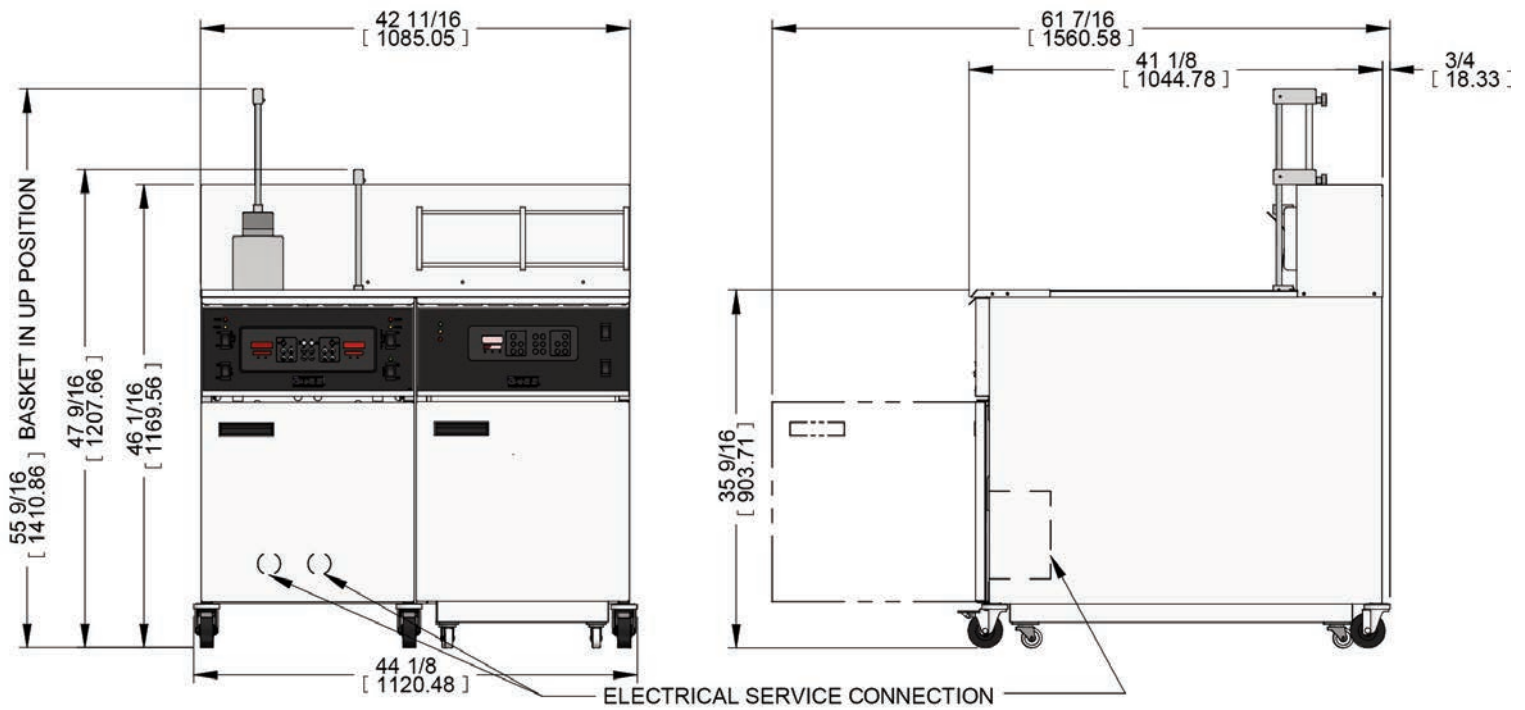

Inches [mm]

1-04.2. Regulatory Listings



1-04.3. Basket Size

Model	Dimensions						Volume	
	Length		Width		Height		In ³	M ³
	In	mm	In	mm	In	mm		
EOF10-10 Vat	9	229	18-1/2	470	5-1/2	140	811	0.005

1-04.4. Vat Size & Oil Capacity

Model	Length (Inside)		Width (Inside)		Height (Top of element to Full Level Mark)		Shortening Capacity (Bottom of Vat to Full Level Mark)			
	In	mm	In	mm	In	mm	Lbs	Kg	Gal	Liter
EOF-10	20	508	10	254	4-1/2	114	55	25	8	30
EOF-20	20	508	20	508	4-1/2	114	110	50	16	59

1-04.5. Shipping Specifications (Crated)

Model	Weight		Crated Size						Cube	
	Lbs	Kg	Length		Width		Height		Ft ³	M ³
			In	mm	In	mm	In	mm		
EOF10-10/20	884	401	76	1,930	50	1,270	61	1,549	134.1	3.8



2. Installation

The following section summarizes the procedures necessary for proper installation of the unit. To avoid possible personal injury or equipment damage, please ensure these procedures are followed.

To ensure compliance with applicable building, health and fire codes, it is advisable that this appliance be installed by a professional kitchen equipment contractor, or service company. **All costs for installation, including materials, labor and fees, are the responsibility of the customer.**

2-01. Location



DO NOT MODIFY, ADD ATTACHMENTS OR OTHERWISE ALTER THIS EQUIPMENT

1. Keep the appliance and surrounding area free and clear from combustible materials, 3" (7.6cm)
2. Please note, a wiring diagrams for each Fryer unit is attached to the rear panel. Ensure that it matches the electrical specifications stated on the rating label.
3. Please ensure this appliance is electrically grounded in accordance with local codes, or in the absence of local codes, with the current National Electrical Code, ANSI/NFPA 70.
4. Please provide adequate room for servicing and proper operation of this appliance. Also, provide adequate ventilation in the operating area as required.
5. Consult with a certified electrician, or other qualified technician, prior to installing this equipment.
6. Ensure the electrical circuits supplying power to the units meet the specifications shown on the rating label of each Fryer unit..
7. Make sure the unit is located on a level floor, in a stable position, and cannot be unintentionally moved. Locking casters are installed along the front of the unit ... place the caster brakes in the locked position. Some commercial codes may require that the unit be secured to an immovable structure (wall, etc.) by means of a restraining cable to restrict movement.
8. Appliance is to be installed, used and maintained in accordance with the current **Standard for Ventilation Control, and Fire Protection of Commercial Cooking Operations, NFPA 96.**

Compliance with the above steps will help to ensure safe and proper installation of this equipment. If there are any questions concerning these procedures, contact a nearby Giles Manufacturer's Representative, or call Giles Technical Support at **800.554.4537**.

2-02. Unpacking

The unit will arrive on a shipping skid, enclosed by a wooden framework. It is secured to the wooden platform by means of high-tensile strength strapping and the entire skid is wrapped in machine-applied stretch wrap. Certain auxillary items (Filter Pan, baskets, fryer tools, etc.) will be packed on top of the unit or contained inside the vats.

CAUTION

- The appliance must remain in an upright (vertical) position during the unpacking process. Exercise care when lifting or moving the unit. Appropriate lifting equipment will be required to remove the unit from the shipping skid. **DO NOT attempt to manually lift the unit, it is extremely heavy.**
- Exercise care when removing the wooden framework from around the unit.
- Failure to comply with these **CAUTION** notices may result in minor or moderate injury, equipment or property damage, and void the factory warranty.

IMPORTANT!

If crate exhibited evidence of damage or mishandling, immediately inspect the unit and all accessory items and notify the freight carrier of any damages. Typically it is the purchaser’s responsibility to file and negotiate freight damage claims.

1. Carefully cut and remove the plastic shipping wrap and the strapping.
2. Using appropriate tools, carefully remove wooden framework and all other packing materials.
3. Remove all the auxillary items (Filter Pan, Baskets, Screens, Brushes & Tools) from the unit and set aside in a safe place.
4. Carefully remove the Fryer bank from the shipping skid. The unit is extremely heavy, see **Section 2-03**. It is strongly recommended to use only motorized lift truck, equipped with extended forks, to lift the unit. Approach unit from the end and ensure that forks are under the unit’s tubular framework. Slowly lift unit only high enough for casters to clear the skid risers. Have helpers slide the skid from underneath the unit, then lower it to the floor. Be sure all casters are unlocked; the Fryer bank can then be easily manuvered manually.

IMPORTANT!

Giles shall not be liable for damages caused to the unit by improper use of material handling equipment or poor work practices, or for personal injuries or property damage which may be incurred during installation of this equipment. Installation is the sole responsibility of the purchaser. Failure to follow these instructions could void the factory warranty.

2-03. Electrical Requirements

CAUTION

- Fryers must be properly grounded. Improper grounding may result in electrical shock to the user. Always refer to local electrical code to ensure that proper grounding techniques are used for this or any other electrical equipment. Always consult with a certified electrician, or other qualified service technician, to ensure that the electrical circuit is of sufficient rating for supplying power to this appliance.
- Fryers are available from the factory wired for various voltage, phase and Hz, see **Table below**. To determine the correct power supply for the appliance, check the serial label found on the rear panel of the Fryer, or inside the cabinet. Each unit of a banked battery requires a separate power service.

2-03.1. Electrical Specifications

Unit	Voltage	Phase	kW	Amp Draw	Circuit Breaker Required
*EOF10-10	208	3	24	68	80
	240	3	24	59	75
	480	3	24	31	50
EOF-20	208	3	24	76	80
	240	3	24	66	75
	480	3	24	33	50

* EOF10-10 unit is a split vat fryer with a single power supply ... kW rating is total of the unit.

2-04. Electrical Connections

NOTE:

Each unit in the Fryer bank requires a separate power supply. Electrical installation materials (breakers, conduit, fittings, wire, etc.) and installation labor shall be supplied by the customer. Work should be performed by a qualified electrician, or service technician.

Installation must comply with local code requirements. Giles is not responsible for code compliance with regard to installation and use of this appliance.

1. As needed, install appropriately sized Circuit Breakers in main breaker panel, see **Table 2-03.1**.
2. **(Recommended)** Install a disconnect switch box between main panel and Fryer.
3. Connect flexible conduit from the Disconnect to the Fryer unit. Allow enough conduit length so that the unit can be moved away from the wall for cleaning and servicing, see **Figure 2-04.1**. Conduit to be routed along the floor underneath the Fryer unit and turn up to a 90° conduit connector installed on the back of the Service Box.
4. Open Fryer unit Door and remove Service Box Cover, see **Figure 2-04.1**.

2-04. Electrical Connections - Continued

- 5. Connect the electrical ground wire between Ground Lug and a proper earth ground.
- 6. Route appropriately size power supply wires to the Disconnect and continue to Fryer.
- 7. Connect the power wires to the appropriate Terminal Blocks inside the Service Box, **see Figure 2-04.1.**
- 8. Reinstall Service Box Cover and close the Fryer unit Door.

2-04.1. Electrical Connections Diagram

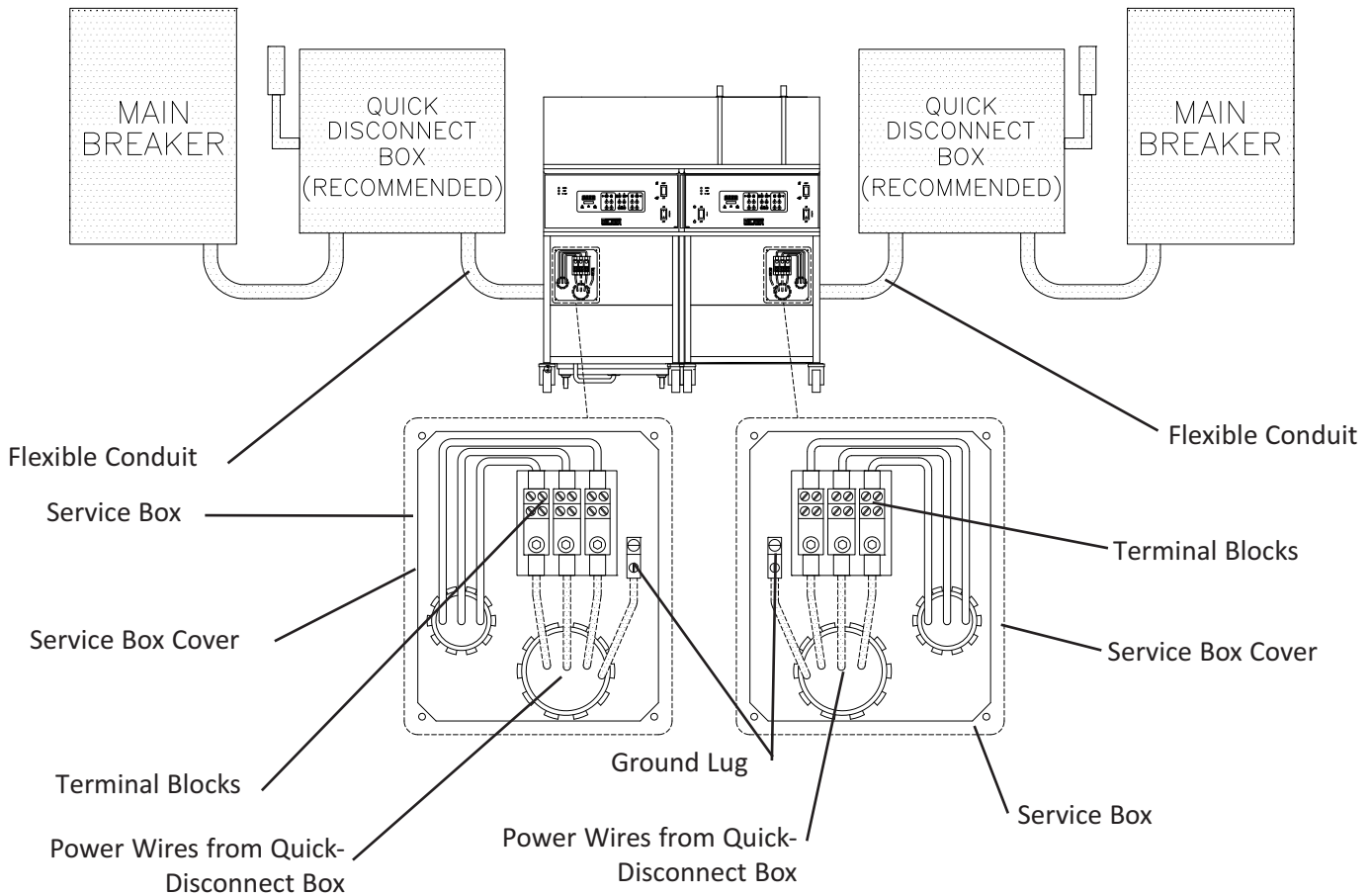

2-05. Ventilation of Fryer

NOTE:

Guidelines and codes for ventilation system requirements may differ from locale to locale. Always consult with the local authorities having jurisdiction to ensure compliance.

Consult a professional ventilation or HVAC company for assistance in determining whether existing systems are sufficient to accommodate this equipment, or in designing a ventilation hood system to comply with code requirements.



3. Overview

The following section provides a brief overview of the components, functions, and accessories of the EOF10-10/20 Fryer unit. Please review this section carefully before proceeding any further.



3-01. Basket Lifts and Baskets

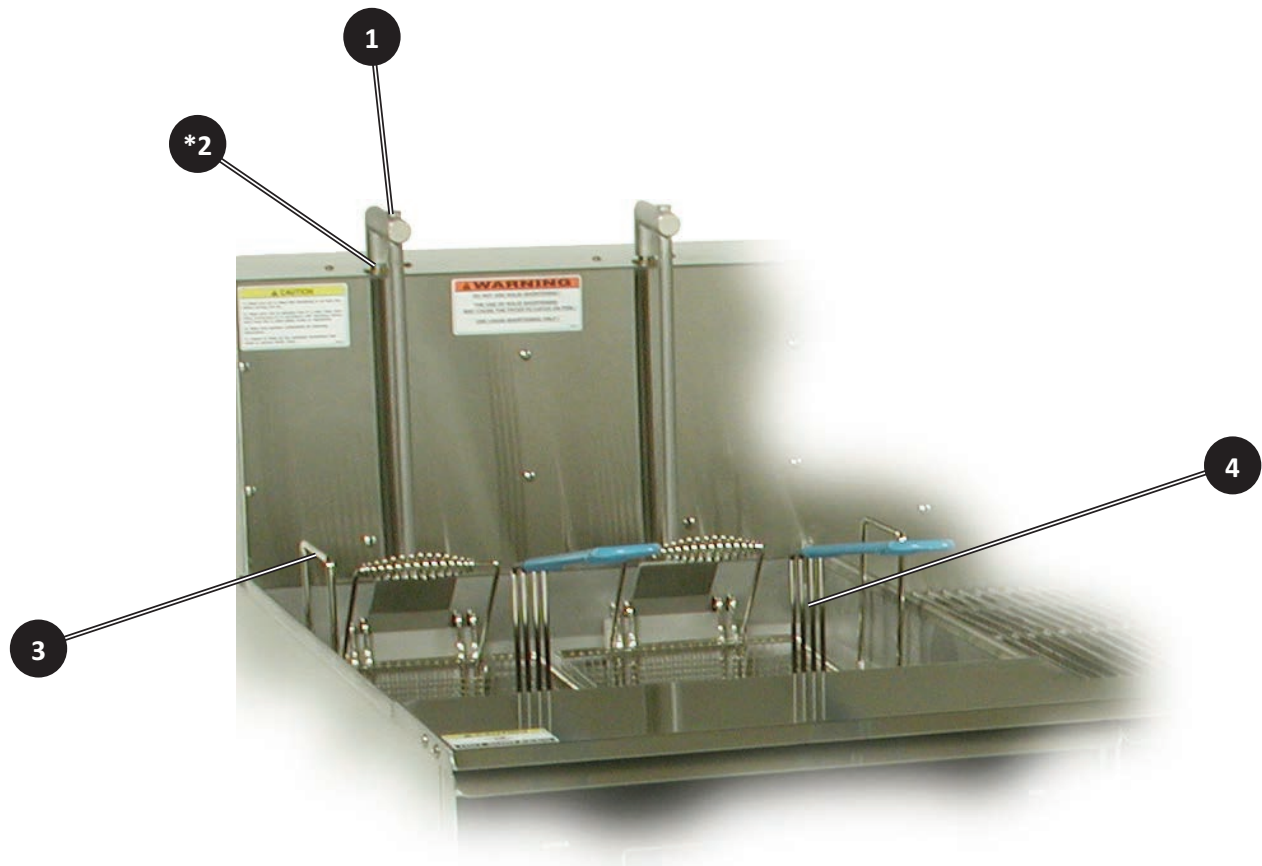



3-01. Basket Lifts and Baskets		
Item	Description	Function
1	Basket Carrier (2)	Holds basket in the proper position as it raised or lowered by the Auto-Basket Lift.
2	Elevator (2)	Lowers or raises the Fry Basket.
3	Fry Screen	Placed inside the Fry Vat to prevent excess breading or product crumbs from falling into and accumulating in the area around the heating elements.
4	Fry Basket (2)	Used to contain product during cooking.



Always wear thermal protection, such as Oven Mitts when handling any of these parts during normal operation ... they can become very hot!

3-02. EOF-20 Basket Hanger and Baskets

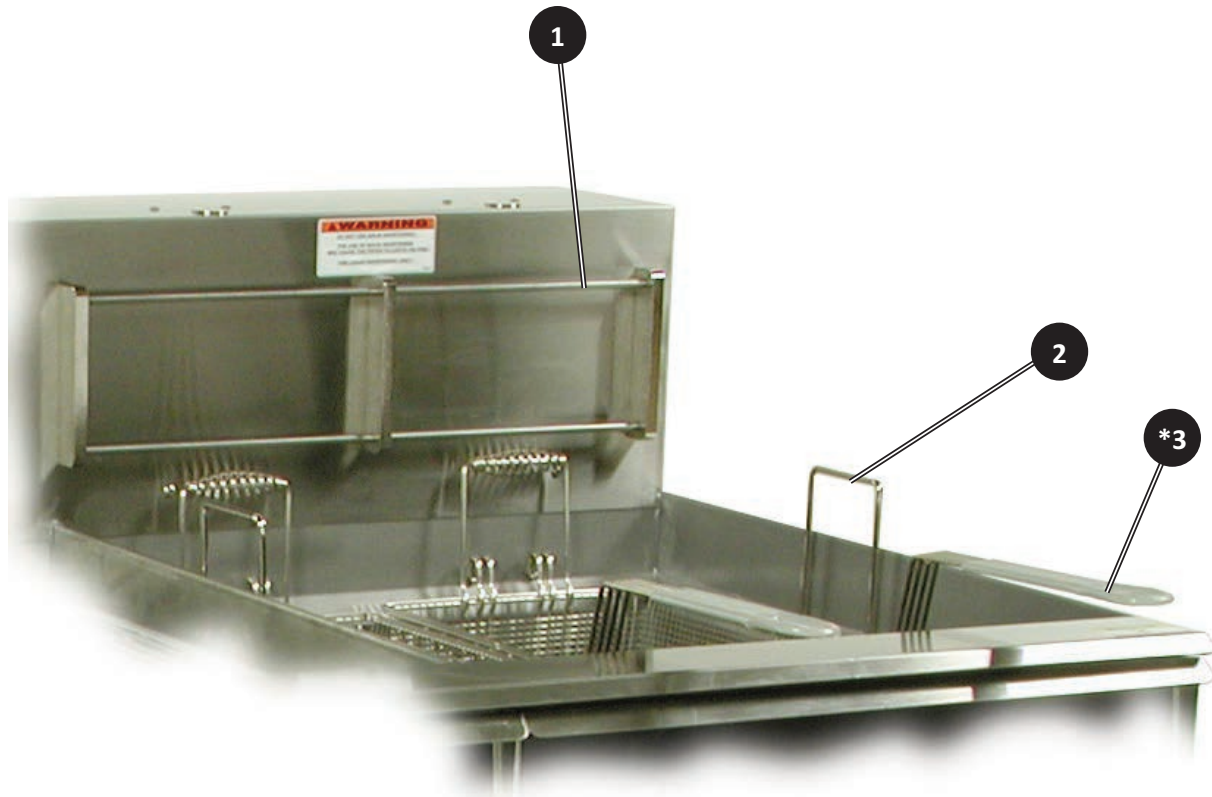



3-02. EOF-20 Basket Hanger and Baskets		
Item	Description	Function
1	Basket Hanger	Holds basket(s) allowing excess oil to drain from cooked product. Hanger located either over right vat.
2	Fry Screen	Placed inside the Fry Vat to prevent excess breading or product crumbs from falling into and accumulating in the area around the heating elements.
*3	*Basket (2)	Contains product during cooking. *NOT INCLUDED FOR EOF20 UNIT, Purchased Separately.



Always wear thermal protection, such as Oven Mitts when handling any of these parts during normal operation ... they can become very hot!

3-03. Control Panel (EOF10-10 Dual Display)

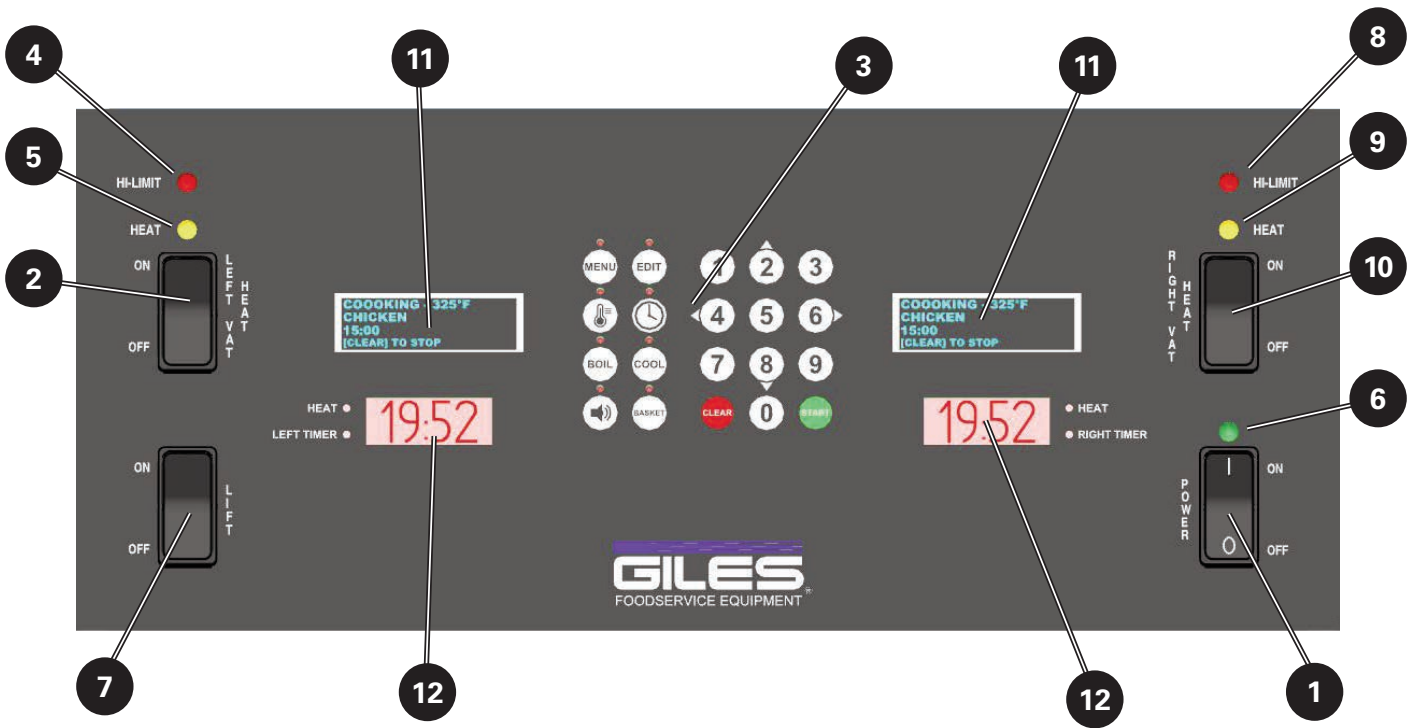

3-03. Control Panel (EOF10-10 Dual Display)		
Item	Description	Function
1	Power Switch	The Power Switch turns Fryer power ON and OFF .
2 & 10	Heat Switch (Left & Right Vat)	Turns power to heating elements ON/OFF . Place Switch in the OFF position when performing certain functions and when unit is shutdown. Place in ON position when ready to heat the oil.
3	Computer Controller (Dual Display)	Computer Cooking Controller ... set cooking temperature and cook times ... controls and monitors fryer functions ... displays alarm conditions and operational instructions. Stores fifty (50) editable Menu Item preset cook settings. Separate display for each Vat.
4 & 8	High-Limit Indicator (Left & Right Vat)	Light is illuminated to indicate shutdown of the heating elements due to excessive heating condition. Should this light turn on during operation, DISCONTINUE COOKING ACTIVITIES and refer to Troubleshooting, Section 7. DO NOT ATTEMPT TO CONTINUE COOKING UNTIL THE CAUSE OF THIS CONDITION IS DETERMINED!
5 & 9	Heat Indicator Light (Left & Right Vat)	Light is illuminated when the Heat Switch is in the HEAT position and the heating elements are energized. This light will cycle ON and OFF during normal operation as the Controller maintains the set-point temperature.
6	Power Indicator Light	Light is illuminated whenever the main Power Switch is in the ON position.
7	Basket Lift Switch	Enables or disables both Basket Lifts. In the LIFT position, basket lift lowers when a cook cycle starts and is raised when cook time expires. In the OFF position, both lifts are disabled and will not operate.
11	Controller OLED Display	Displays Fryer setting information, alarm error messages, menu item preset settings, and various operational messages and prompts. One display for each Vat.
12	7-Segment Display	Main display for actual timer countdown and current actual oil temperature. Also displays various status and/or error codes. One display for each Vat.

3-04. EOF20 Control Panel

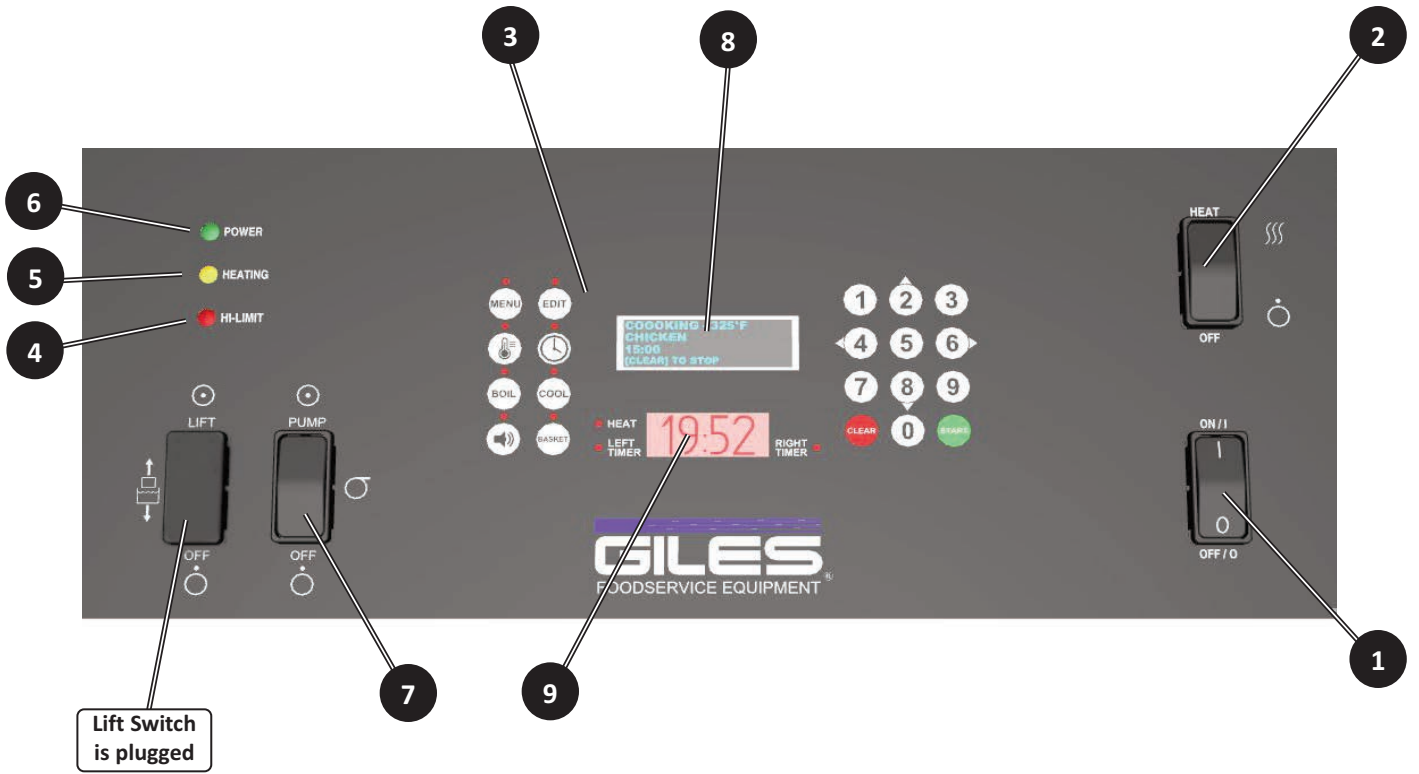

3-04. EOF20 Control Panel		
Item	Description	Function
1	Power Switch	The Power Switch turns Fryer power ON and OFF .
2	Heat Switch	Turns power to heating elements ON/OFF . Place Switch in the OFF position when performing certain functions and when unit is shutdown. Place in ON position when ready to heat the oil.
3	Controller	Computer Cooking Controller ... set cooking temperature and cook times ... controls and monitors fryer functions ... displays alarm conditions and operational instructions. Stores fifty (50) editable Menu Item preset cooking timers. Separate display for each Vat.
4	High-Limit Indicator	Light is illuminated to indicate shutdown of the heating elements due to excessive heating condition. Should this light turn on during operation, DISCONTINUE COOKING ACTIVITIES and refer to Troubleshooting, Section 7. DO NOT ATTEMPT TO CONTINUE COOKING UNTIL THE CAUSE OF THIS CONDITION IS DETERMINED!
5	Heat Indicator Light	Light is illuminated when the Heat Switch is in the HEAT position and the heating elements are energized. This light will cycle ON and OFF during normal operation as the Controller maintains the set-point temperature.
6	Power Indicator Light	The green Power Light illuminates whenever the Fryer's Power Switch is in the ON position.
7	Pump Switch	Turns the Filter Pump ON and OFF for the oil filtering cycle.
8	Controller OLED Display	Displays Fryer setting information, alarm error messages, menu item preset settings, and various operational messages and instructional prompts.
9	7-Segment Display	Main display for actual timer countdown and current actual oil temperature. Also displays various status and/or error codes.

3-05. Lower Cabinet, EOF10-10 (Left-Side)



3-05. Lower Cabinet, EOF10-10 (Left-Side)		
Item	Description	Function
1	Drain Valve Handle	<p>Opens and closes the cook vat Drain Valve. Always be sure the valve is fully CLOSED (tab on handle hooked through panel opening) prior to adding cooking oil, or boil out solution. The Fryer will not heat if the Drain Valve is not completely closed!</p> <p>⚠ DANGER Even though safety interlocks are built in, always be sure the Heat Switch on Control Panel is in the OFF position before opening this valve. Failure to do this could result in fire, causing serious injury, even death, damage to equipment or property, and void the warranty.</p> <p>⚠ WARNING NEVER drain oil from more than one (1) Fryer at a time into the Filter Pan. Doing so will cause the Filter Pan to OVERFLOW! Always pump oil from Filter Pan back to Fryer vat or to an oil disposal container before draining oil from another vat.</p>
2	Oil Return Valve Handle	<p>When in the VAT FILL position, oil is pumped from the Filter Pan back to the Fry Vat, during the filtering process.</p>

3-06. Lower Cabinet, EOF20 (Right-Side)

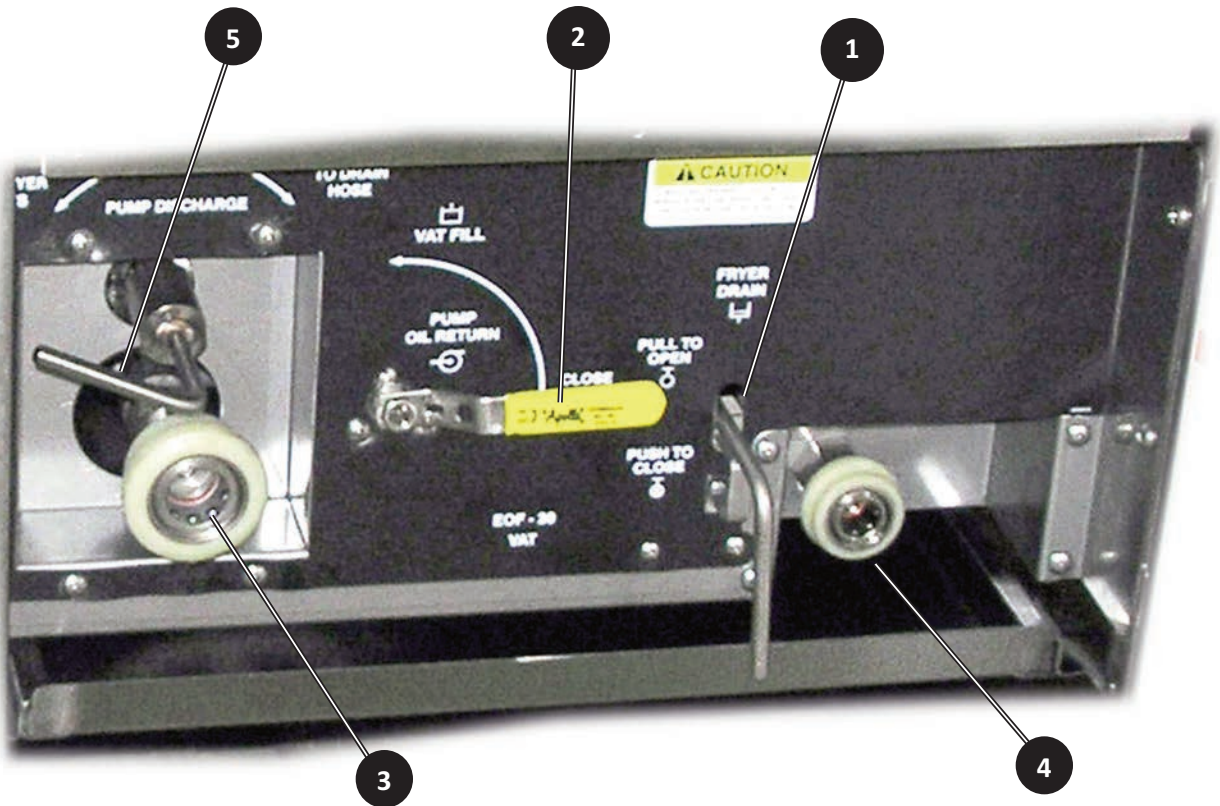

3-06. Lower Cabinet, EOF20 (Right-Side)		
Item	Description	Function
1	Drain Valve Handle	<p>Opens and closes the cook vat Drain Valve. Always be sure the valve is fully CLOSED (tab on handle hooked through panel opening) prior to adding cooking oil, or boil out solution. The Fryer will not heat if the Drain Valve is not completely closed!</p> <p>⚠ DANGER Even though safety interlocks are built in, always be sure the Heat Switch on Control Panel is in the OFF position before opening this valve. Failure to do this could result in fire, causing serious injury, even death, damage to equipment or property, and void the warranty.</p> <p>⚠ WARNING NEVER drain oil from more than one (1) Fryer at a time into the Filter Pan. Doing so will cause the Filter Pan to OVERFLOW! Always pump oil from Filter Pan back to Fryer vat or to an oil disposal container before draining oil from another vat.</p>
2	Oil Return Valve Handle	When filtering oil, set to "VAT FILL" position to return oil to the Fry Vat. Return valves in the left-side cabinet must be set to the "CLOSE" position for proper filling of right-side vat.
3	Oil Discharge Hose Quick-Disconnect	Connects the Oil Discharge Hose to fryer filtration system.
4	Filter Pan Quick-Disconnect	Connects Filter Pan to fryer pump and filtration system. (Located in Right-Side Cabinet on EOF10-10/20 Model)
5	Pump Discharge Diverter Valve Handle	Directs Filter Pump discharge to either return oil to the Cook Vats or send it to the Oil Discharge Hose.

3-07. Filter Pan Assembly

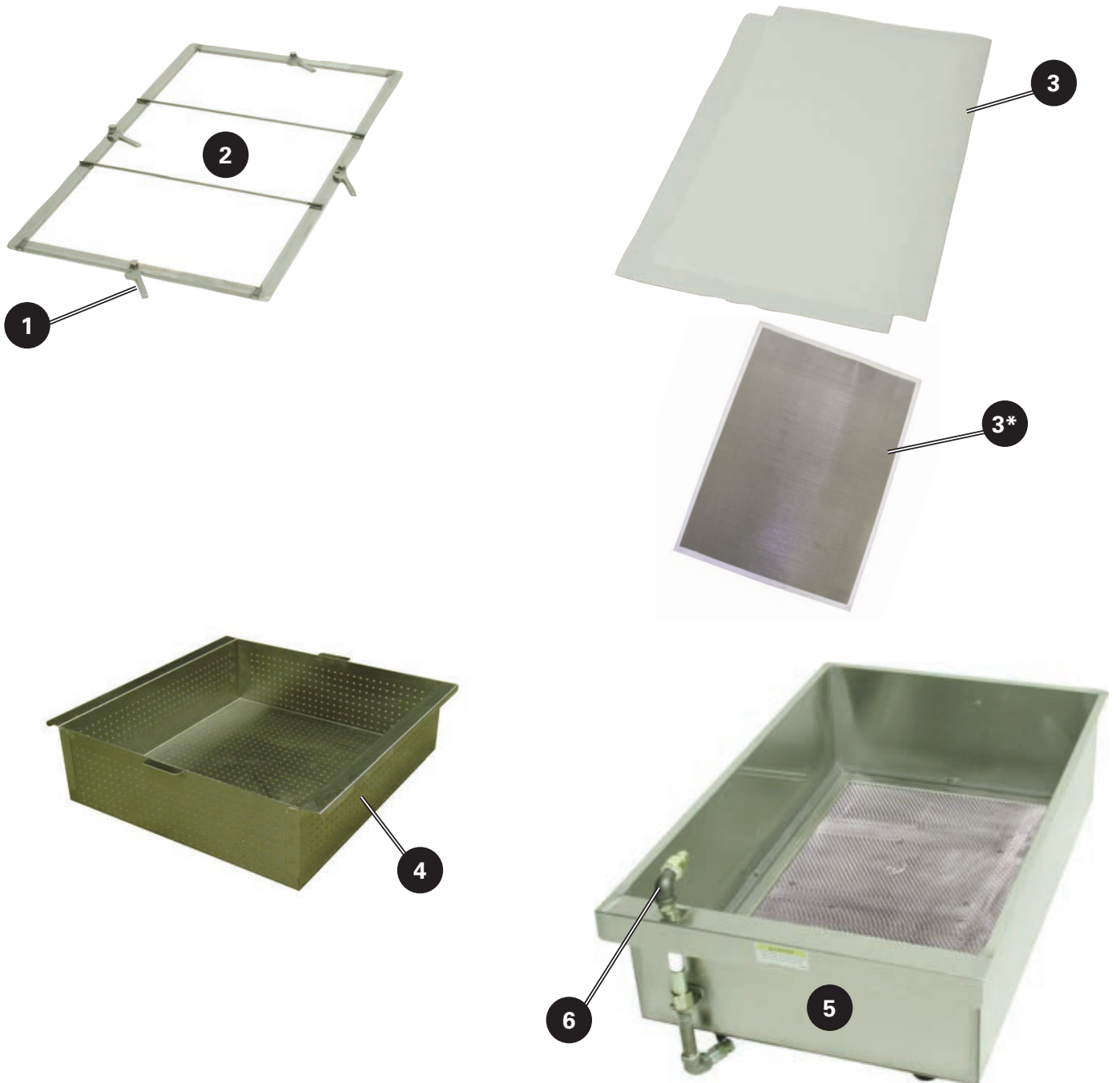

3-07. Filter Pan Assembly		
Item	Description	Function
1	Hold-Down Lever (4)	Secures the Hold-Down Frame tightly against the filter media to create a seal with the Pan bottom.
2	Hold-Down Frame	Holds and seals the filter media (paper or screen) against Filter Pan bottom.
3	Filter Paper Media	Filters residue from cooking oil during the filtering process. One (1) sheet of Filter Paper must be used.
3*	Filter Screen Media (Optional)	Renewable, stainless steel Filter Screen. Optional substitute for Filter Paper. Can be cleaned and reused many times.
4	Crumb Screen	Additional filter element captures large crumbs and residue as oil is being drained into Filter Pan.
5	Filter Pan	Collects oil drained from Cook Vat for filtering or disposal, and contains the filter media. It is easily removed for cleaning, and filter media renewal. Casters provide portability. A permanent perforated screen is affixed to the pan bottom to support filter media, and aid in keeping unintended large debris out of the filter system. IMPORTANT! THIS IS NOT A FILTER; FILTER PAPER, OR SCREEN, MUST BE USED WHEN FILTERING.
6	Filter Pan Quick-Disconnect	Connects Filter Pan to the Fryer oil filtration system. Hose must be securely and properly connected, or pump suction will be lost.









WARNING Never remove the Filter Pan while it contains liquid shortening. Oil spillage and/or burn injury are possible. Please see Section 5.04, Removal of Liquid Shortening.



The Filter Pan is ONLY large enough hold the oil from one (1) Fryer unit. NEVER drain oil from more than one unit at a time into the Filter Pan; doing so will result in overflow.



- Always wear thermal protection, such as oven mitts, when handling these parts. They can become very HOT during normal operations!
- Never drain boil-out solution into the Filter Pan. It is corrosive and will damage the Filter Pan and components, and the Filter Pump. See Section 6.01, Boil-Out Procedure.

3-08. Accessories (Included)		
Part	Description/Part Number	Function
	Kettle Drain Brush P/N: 71025	Used for cleaning the Fry Pot.
	Stir Utensil P/N: 77775	Used for stirring oil and product being cooked.
	Fry Vat Clean Brush P/N: 71100	Used for cleaning Fry Pot and Elements.
	Crumb Shovel P/N: 30059	Used for removing sediment from the Filter Pan.

3-08. Accessories (Included)		
Part	Description/Part Number	Function
	<p>L- Shaped Brush P/N: 73233</p>	<p>Used for cleaning between elements.</p>
	<p>Vat Drain Clean Out P/N: 36577</p>	<p>Used to clear excessive sediment build up from the Vat Drain.</p>
	<p>Oil Discharge Hose P/N: 33667</p>	<p>Used for removing liquid shortening from unit. Note: Not recommended for washing down the fry pot.</p>

3-08. Accessories (Included)		
Part	Description/Part Number	Function
	<p>Fry Basket (Blue Handle) P/N: 70420</p>	<p>Used for cooking product in the EOF-10-10 or the EOF-20.</p>
	<p>(1) EOF-20 Fry Screen P/N: 70083 (2) EOF10-10 Fry Screen P/N: 71110</p>	<p>Used to prevent excess breading or product from contacting the Heating Elements.</p>
	<p>Scoop Basket P/N: 70430</p>	<p>Used for removing cooked product when batch frying without Baskets.</p>

3-09. Accessories (Not Included)

Part	Description/Part Number	Function
	<p>Filter Paper P/N: 60709</p>	<p>Used to filter the cooking oil.</p>
	<p>Filter Powder P/N: 72004</p>	<p>Used to help clean the cooking oil.</p>
	<p>Fryer Boil-Out P/N: 72003</p>	<p>Used to help clean the fry pot.</p>

3-09. Accessories (Not Included)		
Part	Description/Part Number	Function
	<p>Giles Oil Caddy P/N: 79187</p>	<p>A portable oil disposal container with a capacity of 80 lbs of liquid shortening.</p> <p>Note: For use with filtered, warm oil only. No crumbs or debris.</p>

4. Installation Checkout & Preparation

Giles takes pride in the quality of its workmanship. Each unit passes rigorous quality control inspection and testing prior to shipment, and every effort has been made to ensure that the unit is in perfect operating condition when received. To further ensure a smooth start-up, a brief operational check-out of the new unit should be conducted as described in this section.

Start-up assistance and basic operational training by a factory-approved service agent can possibly be arranged if desired. Expense for such service is not included as part of the Fryer purchase. Call Giles at 800.554.4537 for more details.

CAUTION

Before attempting to operate the Fryer, please refer to Section 3 to become familiar with the various controls and their function. After you have read and fully understand Section 3, please precisely follow the steps below to prevent possible equipment damage or malfunction.

4-01. Fryer Settings Before Each Test

Be sure that each Fryer unit's Control Panel and valves are set as follows before proceeding to each test.



EOF-20

1. Power Switch ① in the **OFF** position.
2. Heat Switch(s) ② in the **OFF** position.



EOF10-10

4-01. Settings Before Each Test - Continued

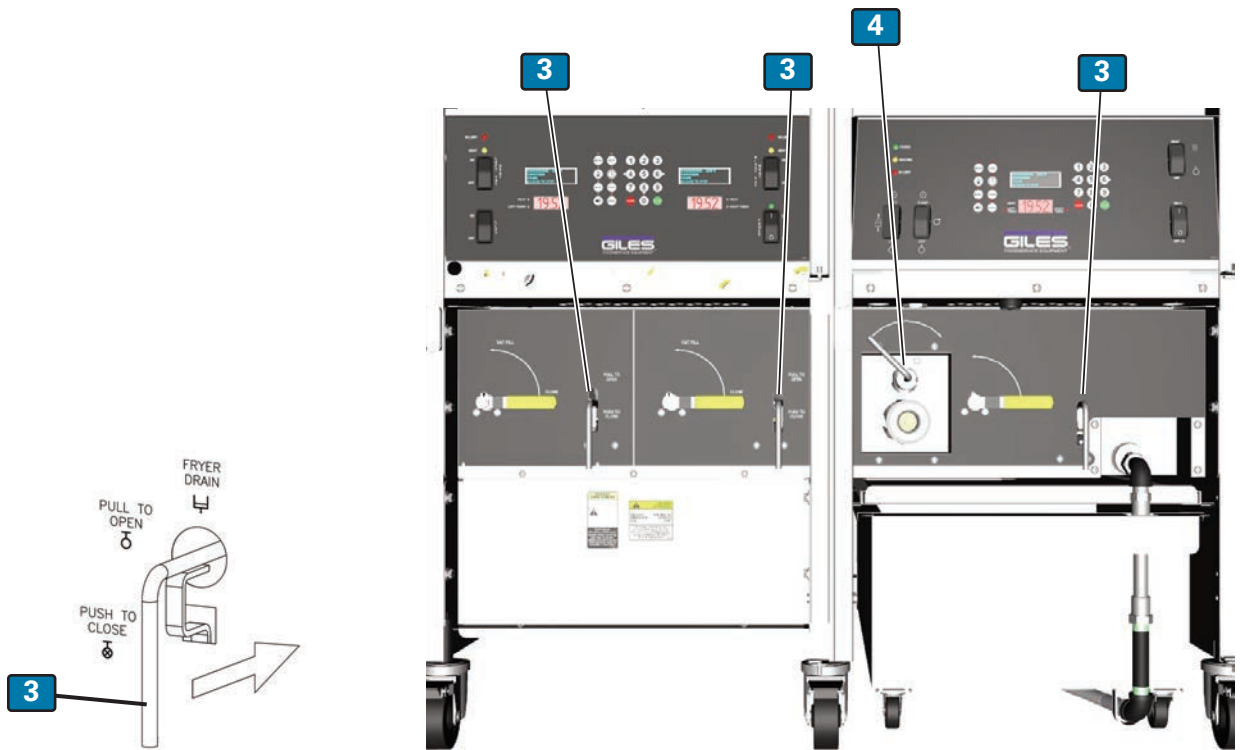

3. Open the Right-side Cabinet Door and remove the Filter Pan.
4. Ensure the Drain Valve Handle on each unit is in the **CLOSED** and Locked (3) position (**tab pushed thru opening & tucked behind panel**).
5. Ensure the Pump Discharge Valve is in the **[TO FRYER]** (4) position.
6. Remove Crumb Screen(s) and Baskets from all cook Vats.

4-02. Power Test

The following test will ensure the unit has power. Perform test on each unit.

1. Follow steps shown in **Section 4-01**.
2. Be sure the main circuit breaker supplying the unit power is **ON**. If a Disconnect Box is used, be sure it is also **ON**.
3. Place the Power Switch **①** in the **ON** position. If the green POWER light **②** illuminates, proceed to **Section 4-03**.

If the POWER light does not come on, refer to the Troubleshooting procedure in **Section 7-01**.



EOF-20



EOF-10-10

4-03. Heating Element Test

The following test will ensure the Heating Element is being powered. **Perform this test on each Fry Pot.**



Heating Elements become extremely hot when energized! Any skin contact with them may result in severe burns.

1. Follow steps shown in **Section 4-01**.
2. Be sure Power Switch is in the **OFF** position.
3. Liberally dampen a sponge with water and wipe down the Heating Element **①**, leaving them visibly wet.
4. Place the Power Switch **②** in the **ON** position.
5. **EOF-20:** Wait for the Controller to power up, sound the alarm signal and show the message **POWER FAILURE PRESS [START] TO PREHEAT** on the **OLED Display** and **[HOLD]** on the **7-Segment Display** **③**.
6. Press the **[START]** key **④** ... the alert signal will silence, and the Controller will indicate **PREHEAT**.
EOF10-10: Message **START WHICH SIDE ... [4]=LEFT, [5]=BOTH, [6]=RIGHT** is shown on the **OLED Display** ... select **BOTH [keypad 5]** then Controller will indicate **PREHEAT**.
7. Set the Heat Switch **⑤** to the **HEAT** position (**both switches on EOF10-10**). The **HEAT** light(s) should turn on. Leave switch(s) in the **HEAT** position **NO MORE THAN 10 to 12 SECONDS**.
Note: During this time, should the **HEAT** light turn off, an alarm sound and the **OLED Display** show a **MAX ELEMENT TEMP** or **LOW OIL LEVEL** error; return Power Switch to the **OFF** position and proceed on to the next step.
8. Return Heat Switch **⑤** to the **OFF** position.
9. The moisture on the heating elements should quickly dry and heat should be felt rising from the Vat. Proceed to **Section 4-04**.

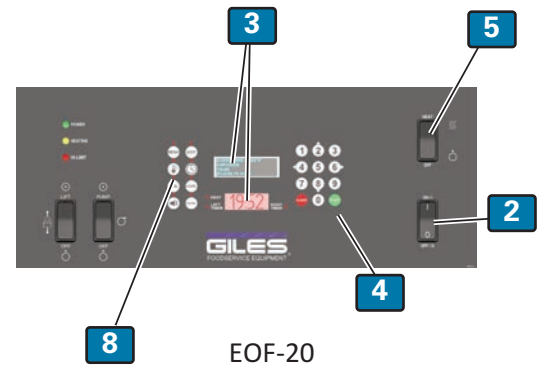
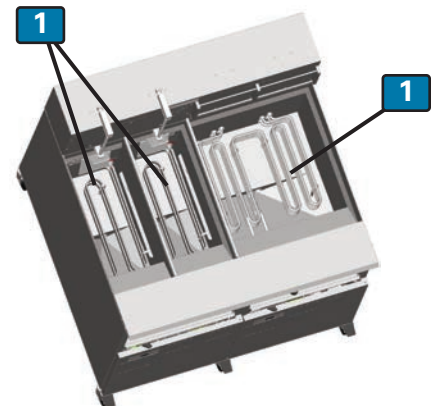

EOF-20

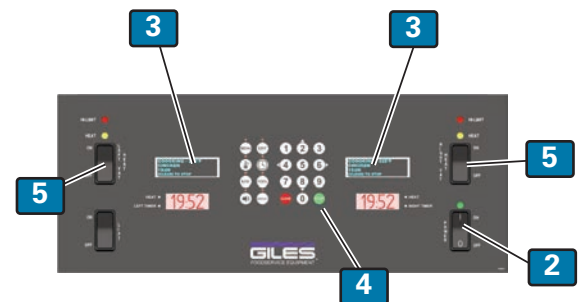

EOF-10-10

If the moisture does not dry within 15-30 seconds, or no heating is detected, refer to the Troubleshooting procedure in **Section 7-01**.

4-04. Filter Pump Test

The following test will ensure the Filter Pump is operating correctly.

1. Follow steps shown in **Section 4-01**.
2. Open right Cabinet Door (EOF-20).
3. Place the palm of your hand over the Filter Pan quick-disconnect fitting **①**.
4. Briefly place the Pump Switch **②** on the Control Panel in the **PUMP** position and allow it to briefly run, then return switch to **OFF**. If suction is felt at the fitting, the pump is operating correctly, proceed to Section 4.05.

If no suction is detected, or if air seems to be blowing outward, refer to the Troubleshooting procedure in **Section 7-02**.



1



2

4-05. Perform Boil Out Procedure

Perform a Boil Out Procedure on each cook Vat to remove any dirt or debris that may have accumulated during shipping, and to remove any residue from manufacturing processes. See **Section 6-01, Boil Out Procedure**. After boil-out is complete, proceed to **Section 4-06**.

4-06. Initial Cleaning Before Cooking

- Disassemble and thoroughly clean the Filter Pan to remove any dirt or debris that may have accumulated during shipping, and to remove any oils or residue that may remain from manufacturing processes. See **Section 6-02, Cleaning Filter Pan & Replacing Filter Paper after Boil-Out**. **NOTE:** It is normal for some surface rust to possibly form on the Hold-down Frame and steel support frame in the Filter Pan during shipment. Typically, any rust can easily be removed with a wire brush or steel wool. Once the unit is in use, it is unlikely that rust will return.
- Wash all accessory items (Screens, Baskets, Basket Scoop, Brushes, tools, etc.) in warm soapy water and dry thoroughly.
- Remove any adhesive protective film that may remain on sheet metal surfaces. This has been left on the unit to help protect the exterior finish during shipment. Clean exterior surfaces with a good quality stainless steel cleaner/polish.

Fryer preparation is now complete; proceed to the Fryer Operation Section.

5. Fryer Operation

EOF Series Fryers are high capacity electric Fryers, banked together into a single unit that features a single oil filtration system. The **EOF10-10/20** banked unit includes an **EOF10-10** Fryer, a split-vat design single unit with two 10x20" cook vats, each separately controlled and an **EOF20** Fryer is a 20" square vat.

DANGER

- Turn off the Fryer power switch and the main supply power at the main electrical panel, or remove plug for receptacle before cleaning or performing maintenance.
- **DO NOT** wash down the Fryer interior or exterior with water from a spray hose, or any other pressure-type washing equipment.
- Failure to comply with **DANGER** notices will result in serious injury, even death, damage to equipment or property and void the factory warranty

WARNING

- **DO NOT** use or store flammable liquids, or materials that produce flammable vapors, in the vicinity of this or any other appliance!
- **DO NOT** for any reason, stand or step onto the top of the appliance, or allow other persons to do the same. Cooking oil in the fry pot can be in excess of **330°F (166°C)**, contact with hot oil will cause extremely serious injury. Covers used to cover the fry vat/pot are made of thin-gauge sheet metal and **WILL NOT** support the weight of a person. 
- Failure to comply with **WARNING** notices could result in serious injury, even death; damage to equipment and/or property and will void the factory warranty.

CAUTION

- Be sure the Fryer is positioned in a stable, safe location with the casters in the locked position.
- Consult an electrician to be certain that all electrical specifications have been met and the unit is properly grounded. A wiring diagram is provided with the unit to aid an electrician.
- Due to the high temperature of cooking oil in the Fryer during cooking, it is extremely important that the user exercise due caution in operating this equipment to avoid personal injury. It is recommended that thermal protective gear, such as mitts or gloves, be worn to avoid potential burn hazards.
- This appliance is not intended for use by persons (including children) with reduced physical, sensory, or mental capabilities, or lack of experience and knowledge, unless they have been given adequate instruction and/or supervision concerning its use by a person responsible for their safety. Children should be supervised, or otherwise restricted, to ensure they do not play with or around this appliance.

5-01. Computer Controller

The following sections explain the functions, features, programming, and operational procedures for the two different Computer Cooking Controllers used on EOF Series Fryers ... **Single & Dual Display.**

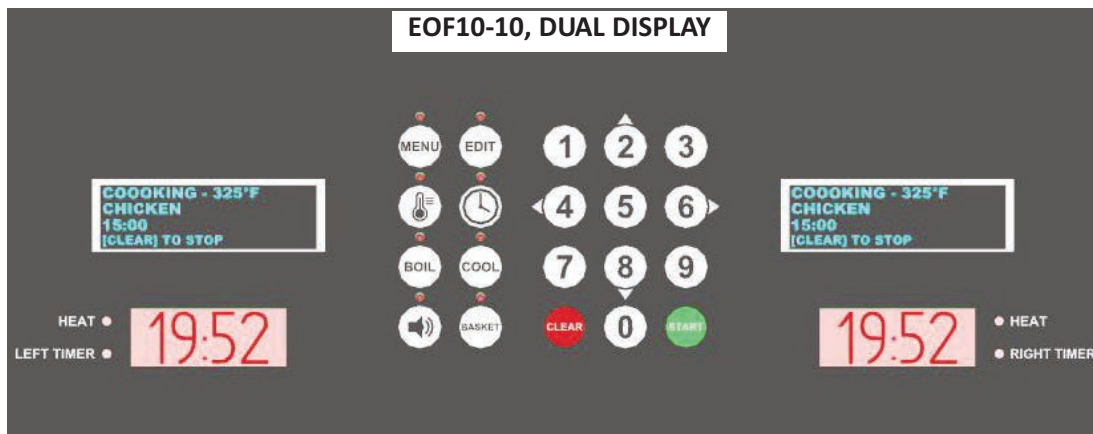

5-01.1 Keys and Functions



Numeric Keypad: Used for entering Fryer settings and to edit preset Menu Item cooking parameters. The [2-4-6-8] keys are also used as [ARROW KEYS] for operating Basket Lifts (if installed), selecting Right/Left timer, navigating through lists, moving the cursor when making edits, etc ... [2] - [8] = UP/DOWN ... [4] - [6] = LEFT/RIGHT. The keys will illuminate to indicate when they are active as directional control keys.

[START]: A multiple use function key used to start cook cycles, select items from lists, save settings, and exit editing, etc.

[CLEAR]: A multiple use function key used to cancel cook cycles, exit editing without saving, etc.

5-01.1 Keys and Functions - Continued



MENU Key: An action key which is pressed in combination with other keys to access programmed Menu Item presets. Fifty (50) Menu Presets are factory-programmed in the Controller.



EDIT Key: An action key which is pressed in combination with other keys to enter edit mode for changing or creating Menu Item preset settings.



TEMP Key: Press this key to begin manually setting a cooking oil temperature setpoint. Pressing this key twice (2x) will display the ACTUAL OIL TEMPERATURE on the 7-Segment Display for approximately 20 seconds.



CLOCK Key: Press this key to begin manually setting a cooking time (mm:ss).



Press this key during preheat to enter the **BOIL OUT** mode. Temperature setpoint and time changes to the **BOIL TEMP** and **BOIL OUT TIME** as specified in **USER SETTINGS** (see Section 5-01.7, Access & Edit User Settings) ... default = 200°F & 30 minutes.



Press this key to enter **COOL** mode, which allows the Fryer to idle at a lower temperature during inactive periods to save energy. Temperature setpoint changes to the **COOL TEMP** specified in **USER SETTINGS** (see Section 5-01.7, Access & Edit User Settings) ... default setting = 275°F.



ALARM Reset Key: Pressing this key silences the Controller alarm and acknowledges certain status messages.



BASKET Key: Pressing this key activates the **UP/DOWN [2] - [8]** keys to manually operate Fryer Basket Lifts. The key is disabled during **PREHEAT** to prevent user from lowering basket into cooking oil that is not yet at cooking temperature. Key is **ONLY** active if Basket Lifts are installed in the unit.



OLED Display: Displays menu preset information, certain Fryer status information, and operational instruction messages. Two (2) on Dual Display.



7-Segment Display: Displays various status information, cook cycle time countdown, temperature, etc. Two (2) on Dual Display.



Indicators: **[HEAT]** illuminates to indicate that Controller is calling for heating elements to energize. **[LEFT/RIGHT Timer]** illuminates to indicate the active basket timer; time shown on 7-Segment Display.

5-01.2 Controller General Operation

The following is general operational information for the Computer Cooking Controller. Detailed procedures are presented in subsequent sections. During operation, certain instructions will be shown on the **OLED Display** to aid Users in operation. Certain keys and indicator lights will also illuminate to further guide the User through various processes.

- POWER UP:**
 Place **POWER SWITCH** in **ON** position. After the Controller boots up, an alarm tone sounds and the message **POWER FAILURE [PRESS START TO PREHEAT]** is shown on the **OLED Display**. This is normal, intended to prevent the Fryer from beginning to heat after a power interruption until attended by an operator. Pressing the **START** key silences the alarm and puts the Fryer into **PREHEAT** mode. If the **HEAT SWITCH** is in the **[HEAT]** or **[ON]** position, and the temperature setpoint is higher than the current actual oil temperature, the heating elements will turn on and the cooking oil will begin to heat.
- PREHEAT:**
 During **PREHEAT**, the real-time actual oil temperature is displayed on the **7-Segment Display**. When oil reaches the programmed setpoint, an alarm tone sounds, the **OLED Display** will read **ALARM STIR OIL (NOTE: This may occur at different times for split-vat EOF10-10)**. Vigorously stir the cooking oil then press **[ALARM]**. Typically, oil temperature will drop when stirred; Controller delays 10 seconds after **[ALARM]** key is pressed, if oil temperature drops below setpoint, Fryer remains in **PREHEAT** mode until it returns to setpoint. **This process will ensure that temperature is more uniform throughout the total volume of oil, leading to better cooking performance.** Upon reaching setpoint, the alarm sounds again and the **OLED Display** reads **ALARM - SETPOINT REACHED**. After acknowledging the signal by pressing the **[ALARM]** key, the Fryer enters **READY** state.
- READY STATE:**
 The Fryer is ready for cooking. The current programmed temperature setpoint is shown on the **7-Segment Display** and the last used cooking parameters (preset or input information) are shown on the **OLED Display**.

While in **PREHEAT** or **READY** state, User can select (or change) a Menu Item Preset, see **Section 5-01.4.1, Selecting a Menu Preset -OR-** User can manually set a different cooking time and/or oil temperature, see **Section 5-01.3, Set a Manual Temperature & Cook Time**.

NOTE: If the PASSCODE ENABLE is set to ON, User cannot set a manual time or temperature without first entering the proper password. This lockout feature provides a measure of control over cooking procedures.

- START:**
 Current cook settings will be shown on the **OLED Display** for each Basket side or Vat side (dual display). To start the cooking cycle timer (a). **EOF20/24**, press the **[START]** key + select BASKET side: **[4] = Left, [6] = Right, [5] = Both ...** (b). **EOF10-10**, press the **[START]** key + **[4]** for **LEFT VAT** or **[6]** for **RIGHT VAT**.

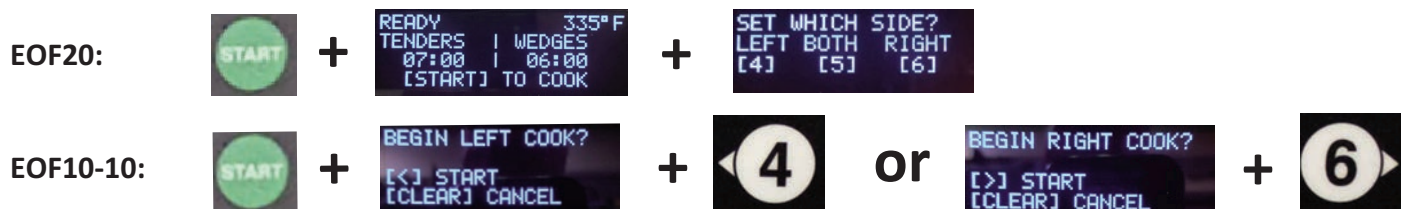

5-01.3. Setting the Cooking Temperature, EOF-20 Single Display

Cooking temperature setpoint is input manually as shown below. Menu Item presets in this Controller do not contain a cooking temperature setting.

Instructions are shown on the **OLED Display** to help guide User through the process.

FOR EOF-20 FRYER

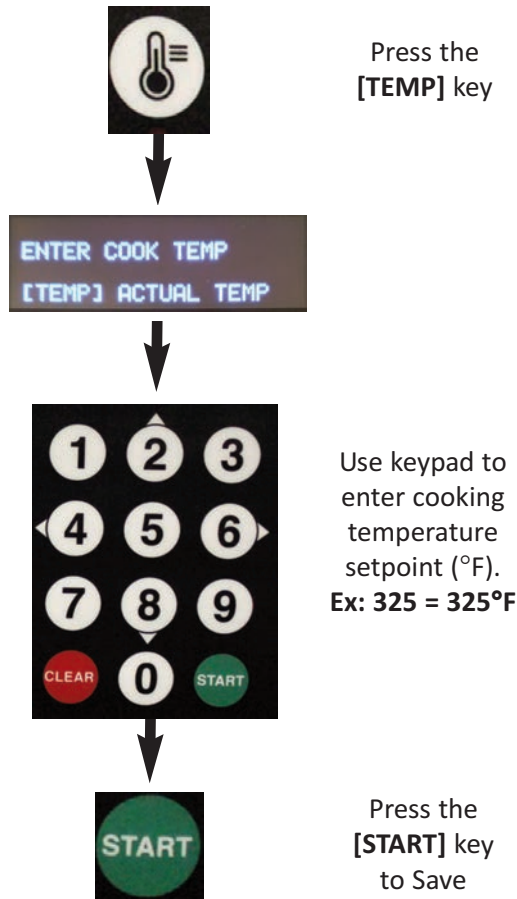

- If actual oil temperature is lower than the entered setpoint temperature when [START] is pressed, the Controller enters **PREHEAT** mode (red **HEAT** indicator beside **7-Segment Display** turns **ON**), however before oil will actually begin heating, the **Heat Switch must be placed in the [HEAT] position**; the amber **HEAT** indicator on the Fryer Control panel should turn **ON**.
- If the oil temperature is already equal to or greater than the entered setpoint, an alarm sounds and the message **SETPOINT REACHED** is displayed. Press the [ALARM] key and the Controller will enter **READY** state. Fryer is ready for cooking.

While heating, real-time actual oil temperature will show on the **7-Segment Display**. After setpoint is reached, the display shows the temperature setpoint.

NOTE:

Pressing the [TEMP] key twice (2x) will display the actual oil temperature for 20 seconds.
The default unit for Temperature is °F ... this can be changed in **USER SETTINGS**, see **Section 5-01.8**.

5-01.3.1 Manually Setting the Cooking Temperature, EOF10-10 Dual Display

Each side of the EOF10-10 unit is a separate cook Vat capable of maintaining a different cooking temperature. **Menu Item Presets** stored in the Dual Display Controller include a temperature setting, as well as Menu Item Names and cooking times, however rather than selecting a preset, temperature can also be manually set as described below.

Information will be shown on the **OLED Display** to help guide Users through the process. **NOTE: The left-hand display is the active display when entering settings.**

IMPORTANT!

If the **PASSCODE** feature is enabled, cooking **TEMP** cannot be manually input without first entering the required password. Without password, Users can only choose from the programmed **Menu Presets** available, see **Section 5-01.5, Working with Menus.**

NOTE:

Pressing the **[TEMP]** key twice (2x) will display the actual oil temperature of each Vat side for 20 seconds on the respective 7-Segment Display.

Default unit for Temperature is **°F** ... this can be changed in **USER SETTINGS**, see **Section 5-01.8.**

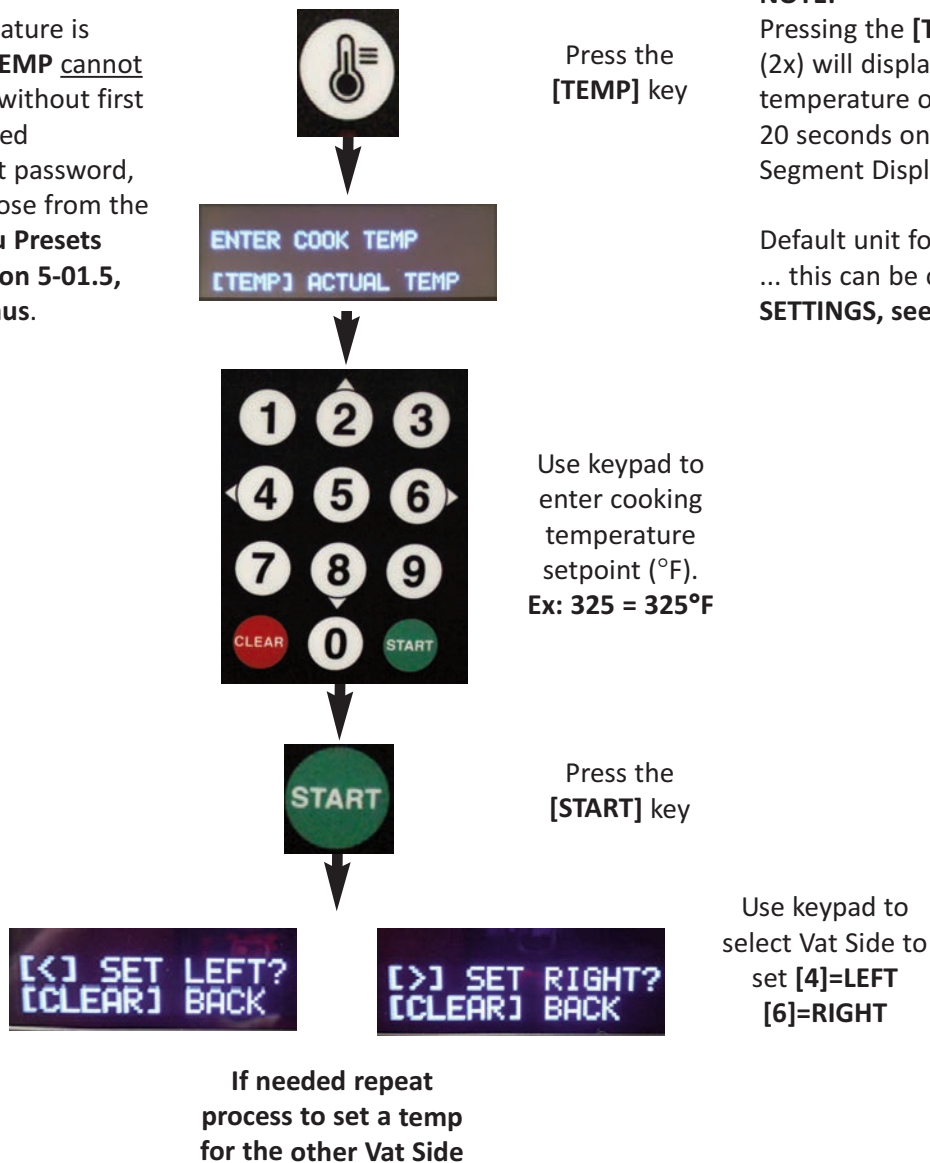

NOTE: Menu Presets contain Item Names which are normally displayed on the **OLED Display**. Manually inputting a cooking temp is a deviation from a preset default, therefore the Name shown on the display will change to **[MANUAL]**.



5-01.4 Manually Setting a Cook Time

The following explains the procedure for manually inputting a cooking time, rather than selecting a preset.

IMPORTANT!

If the **PASSCODE** feature is enabled, cooking **TIME** cannot be manually input without first entering the required password. Users without a password can only choose a programmed Menu Preset from available selections, see **Section 5-01.5, Working with Menus.**

5-01.4.1 Manually Setting a Cook Time - EOF-20 Single Display

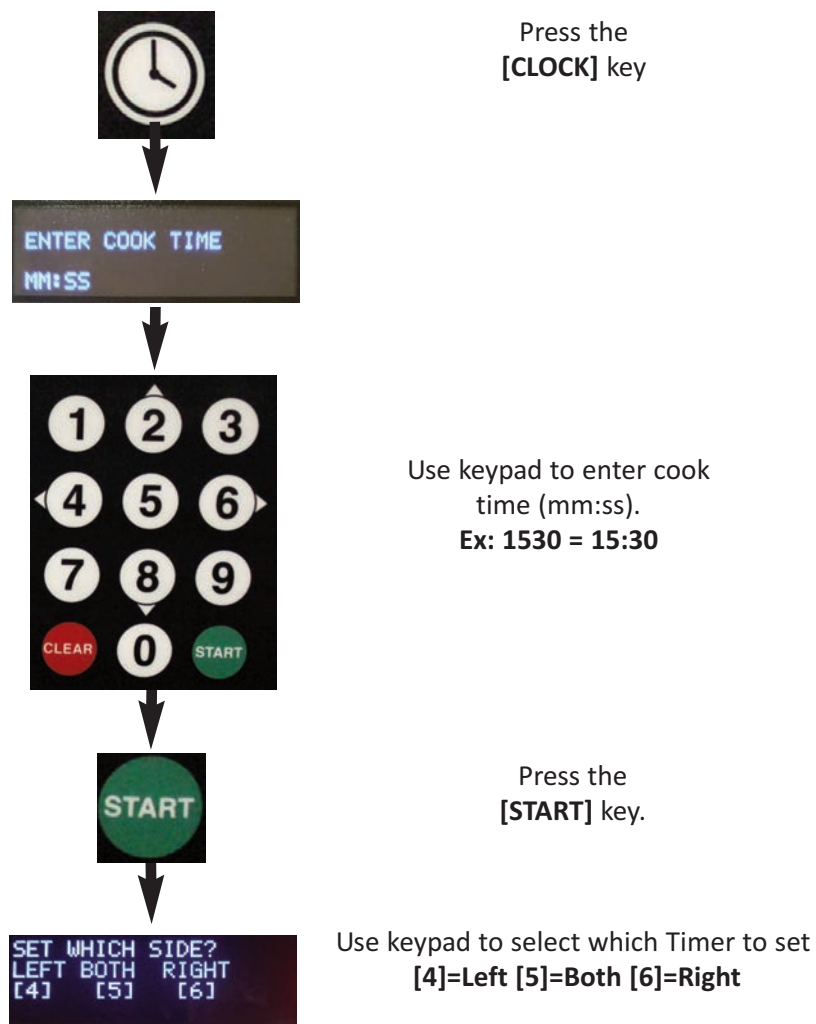

If needed repeat process to set a time for the other Basket Timer

NOTE: Menu Presets contain Item Names which are normally displayed on the **OLED Display**. Manually inputting a cooking time is a deviation from a preset default, therefore the Name shown on the display will change to [MANUAL].



5-01.4.2 Manually Setting the Cooking Time - EOF10-10 Dual Display

The following procedure is for manually inputting an oil temperature setpoint, rather than selecting a preset. Information is shown on the **OLED Display** to help guide Users through the process. **NOTE: Left-hand Display is always the active display while entering setting values,**

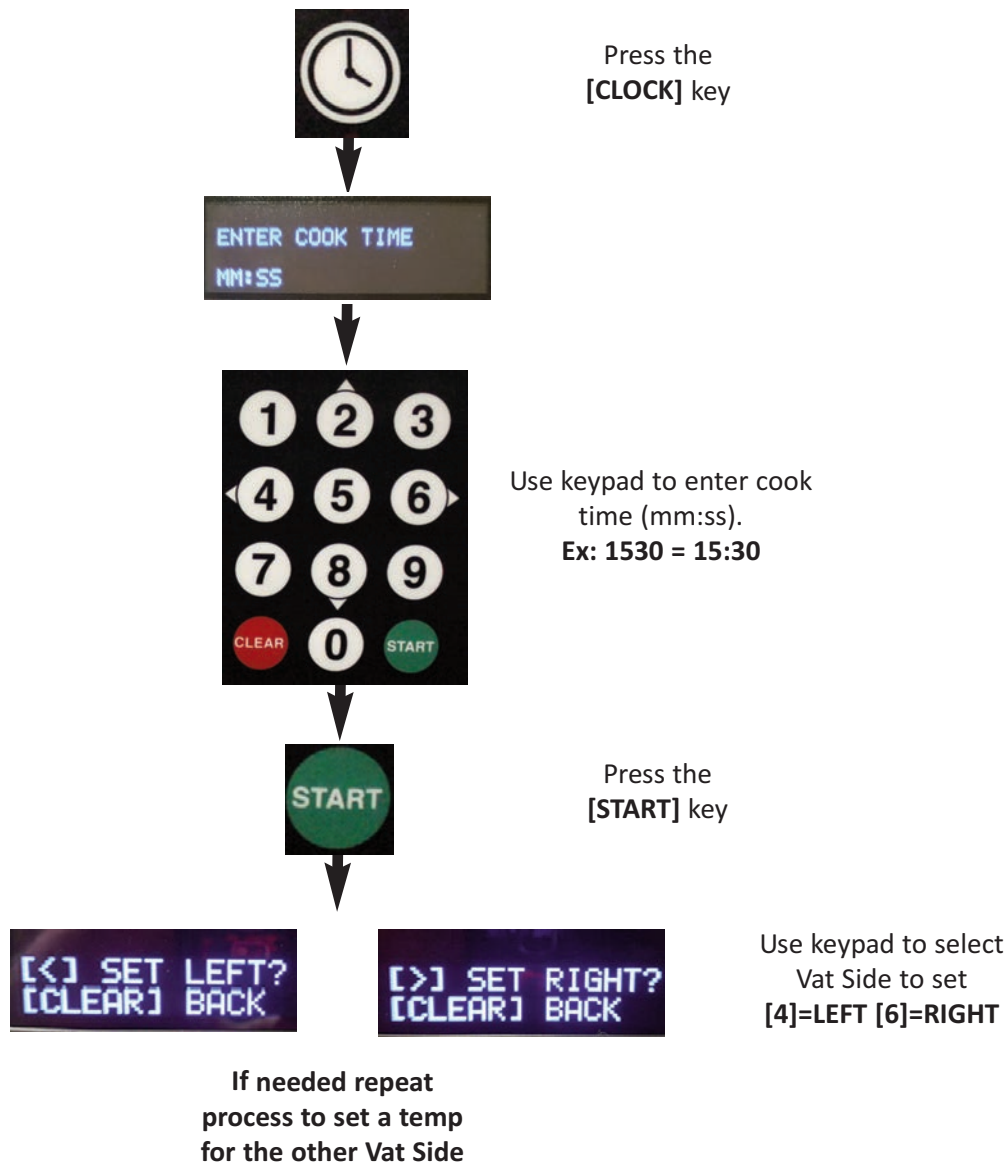

NOTE: Menu Presets contain Item Names which are normally displayed on the **OLED Display**. Manually inputting a cooking time is a deviation from a preset default, therefore the Name shown on the display will change to [MANUAL].



5-01.5 Working with Menus

Fifty (50) Menu Item cook settings are preset and stored in the Computer Controller, each including a:

- **Menu #** - Sequential ID number
- **Menu Name** - Name of the food item assigned to the preset.
- **Cooking Time** - Cook time setting for the specific food item.
- **Cooking Temperature (EOF10-10 Unit ONLY)** - Cooking oil temperature setting for the specific food item. Temperature setpoint is automatically changed to this setting when the Preset is selected for cooking.
- **STIR OVERRIDE** - Some products may or may not require stirring regardless of the global **STIR ALARM** setting ... this Menu Item setting overrides the global setting specified in **USER SETTINGS**. **Default = [NORMAL]**.
- **FISH FILTER** - To minimize flavor transfer, establishments cooking seafood products may wish to force operators to filter oil after cooking only one (1) batch of the item. A **SNOOZE** feature is provided should more than one batch of seafood be needed. The setting overrides the **FORCE FILTER** setting specified in **USER SETTINGS**. **Default = [OFF]**.

All 50 Presets are factory-set with default settings. Users can edit settings as needed to customize for specific applications and menu offerings. The first ten (10) Presets are set up with specific menu names and settings, which represent some popular menu offerings (see table below). The remaining presets contain the general settings as shown on the last line of the table.

Details for working with Menu Item Presets are covered in the following sections.

MENU NO.	MENU NAME	*TEMP (F°)	TIME (MM:SS)	STIR OVERRIDE	FISH FILTER
1	BONE-IN-CHICKEN	335°	13:00	NORMAL	OFF
2	TENDERS	335°	7:00	NORMAL	OFF
3	WEDGES	335°	6:00	NORMAL	OFF
4	BONE-IN-WINGS	335°	8:00	NORMAL	OFF
5	BONELESS WINGS	335°	7:00	NORMAL	OFF
6	POPCORN CHICKEN	335°	3:00	NORMAL	OFF
7	LIVERS	335°	4:00	NORMAL	OFF
8	CORNDOGS	335°	10:00	NORMAL	OFF
9	CHEESE STICKS	335°	3:00	NORMAL	OFF
10	FISH	335°	3:00	NORMAL	OFF
11 thru 50	MENU XX	335°	2:00	NORMAL	OFF

* Applies ONLY to EOF10-10 Unit w/Dual Display Controller

5-01.5.1 Selecting a Menu Preset for Cooking

Direct Entry: The two (2) methods described below can be used when the desired Menu No. is known.

Method (A)

Method (B)

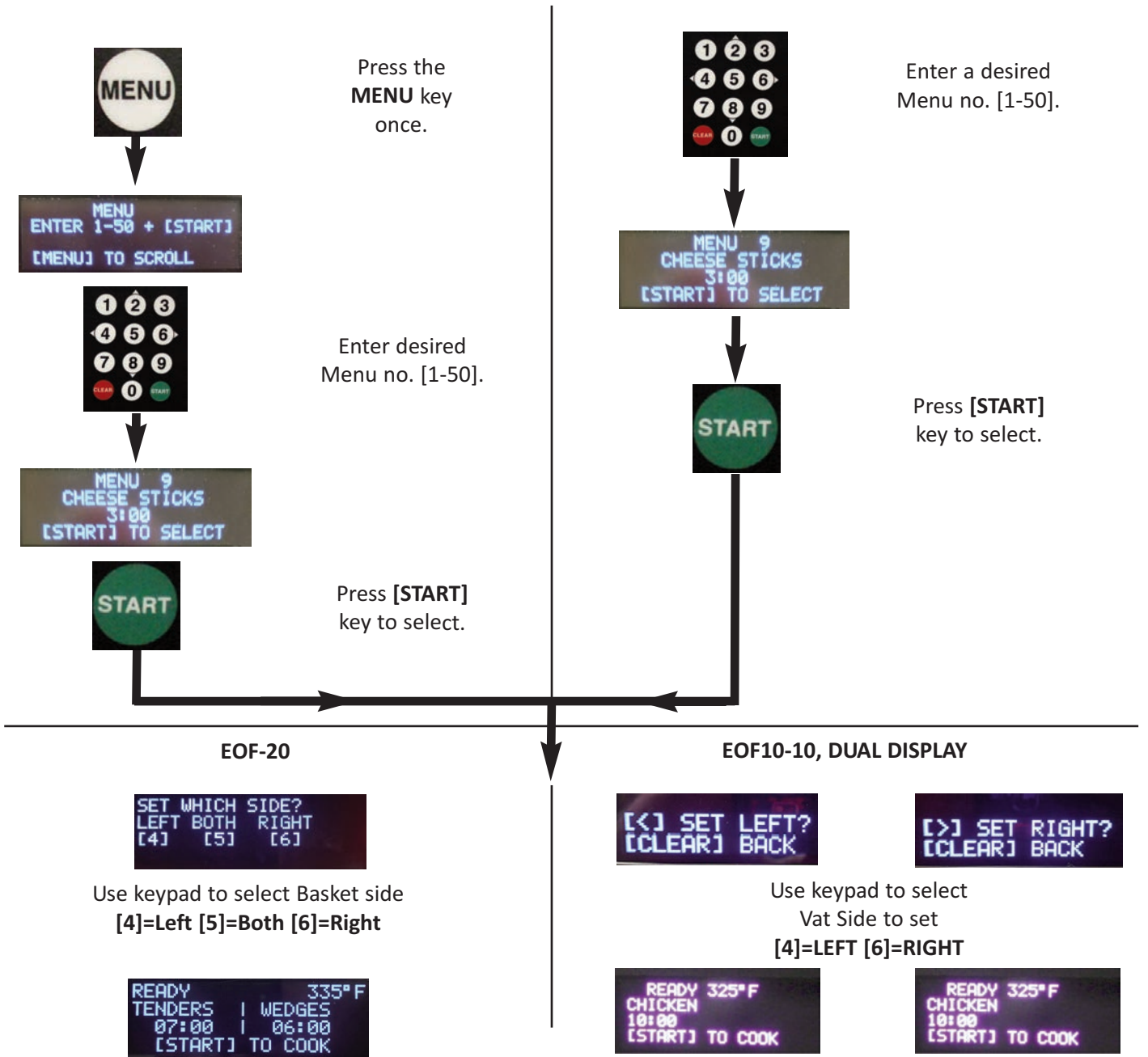

After selecting a desired Menu Preset, pressing the **[START]** key begins a cook cycle, see **Section 5-01.6**. If the actual oil temperature is lower than temperature setpoint and the **Heat Switch is in the [HEAT] or [ON] position** the Controller will enter **PREHEAT** mode and oil begins heating. If the oil temperature is at setpoint, the Controller will enter **READY** state and Fryer is ready to cook..

Continued on Next Page

5-01.5.1 Selecting a Menu Preset for Cooking - Continued

Scroll Method: If the Menu No. is not known, User can scroll through the list of Menu Presets to select the desired item ... Menu No., Name, Cook Time & Cook Temp are shown on the **OLED Display**.



Press the **[MENU]** key twice (2x)

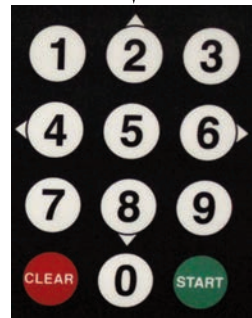

Use numeric keypad **[2]** & **[8]** (UP/DOWN) to scroll through list to a desired Menu



Press the **[START]** key to select Menu item

EOF-20

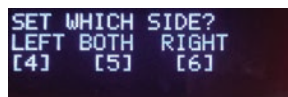

Use keypad to select Basket side
[4]=Left [5]=Both [6]=Right



EOF10-10, DUAL DISPLAY

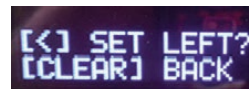

Use keypad to select Vat Side to set
[4]=LEFT [6]=RIGHT

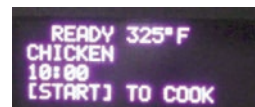

After selecting a desired Menu Preset, pressing the **[START]** key begins a cook cycle, see **Section 5-01.6**. If the actual oil temperature is lower than temperature setpoint and the **Heat Switch is in the [HEAT] or [ON] position** the Controller will enter **PREHEAT** mode and oil begins heating. If the oil temperature is at setpoint, the Controller will enter **READY** state and Fryer is ready to cook..

5-01.5.2 Editing a Menu Preset

NOTE: Left-hand side on Dual Display Controller is the active display when editing Menu Items.



Press the [MENU] key twice (2x)



Use numeric keypad [2] & [8] (UP/DOWN) to scroll through list to the desired Menu No.



Press the [EDIT] key to select & display current Menu settings.

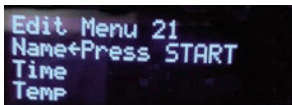

Use numeric keypad [2] & [8] (UP/DOWN) to select what to edit

- [NAME]
- [TIME]
- [TEMP]

[TEMP] is NOT available for editing on the EOF-20 Controller



Press [START] key to begin edit

Editing [NAME] - Method 1:
Letter by letter.



Select edit **NAME** as shown on left. Flashing cursor is positioned at 1st letter. Use keypad [2] or [8] (UP/DOWN) to scroll through letters, changing the character at cursor position. Stop at desired character, then use [4] or [6] (LEFT/RIGHT) to move cursor to next character and repeat.

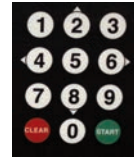

When finished editing **NAME**, press **START** to Save -OR- press **CLEAR** to cancel and exit without saving



Editing [NAME] - Method 2:
Select from Catalog of programmed names.



Select edit **NAME** as shown on left. Flashing cursor is positioned at 1st letter.



Press [0] key to open Catalog of programmed names and use keypad [2] or [8] (UP/DOWN) to scroll through the list. Press **START** to copy **NAME** into Menu Item being edited and return to previous display.



When finished editing **NAME**, press **START** to Save -OR- press **CLEAR** to cancel and exit without saving -OR- [0] to re-open catalog.



Continued on Next Page

5-01.5.2 Editing a Menu Preset - Continued

Edit COOKING TIME: Scroll to and select [TIME] as shown on previous page.



Current time setting is displayed.
Use numeric keypad to enter a new **TIME (mm:ss)**
NOTE: All digits must be entered, ex: 500 = 5:00.

After entering new **TIME** value press the
START key to Save
-OR-
press **CLEAR** to exit without Saving



Edit SETPOINT TEMPERATURE - EOF10-10 UNIT ONLY: Scroll to and select [TEMP] as shown on previous page.
NOT a preset value on the EOF-20 Unit; TEMP must be input manually.
See Section 5-01.4.1, Manually Setting the Cooking Temperature - Single Display

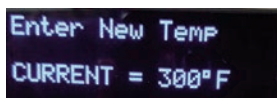

Use numeric keypad to enter new **TEMP (°F)**
Ex: 325 = 325°F
NOTE: TEMP unit can be changed to (°C) in USER SETTINGS, see Section 5-01.7

After entering new **TEMP** value press the
START key to Save
-OR-
press **CLEAR** to exit without Saving



5-01.5.2 Editing a Menu Preset - Continued

Edit STIR OVERRIDE Setting:

Certain food products may, or may not, require stirring during the cook cycle, regardless of how the global **STIR ALARM** setting in **USER SETTINGS (Section 5-01.8)** is specified. **STIR OVERRIDE** is provided so that the **STIR ALARM** can be individually set for particular menu items. Options = **[SKIP]**, **[FORCE]**, or **[NORMAL]**. When set to **[SKIP]** or **[FORCE]** the stir alarm will be either skipped or forced on, regardless of the global setting. When set to **[NORMAL]**, the stir alarm will occur as specified by the global setting ... default = **[NORMAL]**

To edit **STIR OVERRIDE** setting, scroll to and select **[STIR]** as shown on Page 38 ... **[>]** pointing to **[STIR]**

Press the **[START]** key to toggle between the available options.



Edit FISH FILTER Setting:

To minimize potential for flavor transfer to other products, establishments cooking seafood items may wish to force operators to filter oil after cooking only one (1) or two (2) batches of the item. When **FISH FILTER** is set to **[ON]**, the unit will enter **FILTER Mode** after completing one (1) cook cycle of the specific item. If **FORCE FILTER SNOOZE** is set to **[ON]** in **USER SETTINGS (Section 5-01.8)**, operator is allowed to cook one (1) additional batch of seafood before being forced to filter oil. If **FORCE FILTER=[OFF]** in **USER SETTINGS** a filter warning message is displayed on the Controller; if **FORCE FILTER=[ON]**, the fryer is locked out until the filter cycle is completed.

To edit **FISH FILTER** setting, scroll to and select **[FISH FLTR]** as shown on Page 38 ... **[>]** pointing to **[FISH FLTR]**

Press the **[START]** key to toggle between the available options.



When all editing of the selected Menu Item Preset is complete, press the **[CLEAR]** key. All settings for the edited preset are displayed for confirmation. If correct, press **[CLEAR]** key again to return to the **READY** display. To return to editing, press the **[EDIT]** key once again.

5-01.6 Cooking Cycle, General Overview

EOF-20 SINGLE DISPLAY



The temperature **SETPOINT**, **MENU NAME**, and **COOKING TIME** currently selected for each Basket side are shown on the **OLED Display**.



When in **READY** state the Temperature setpoint is shown on **7-Segment Display**. The **READY** message indicates that the cooking oil is at proper temperature and the Fryer is ready for cooking.



To start the cook cycle press the **[START]** key once.

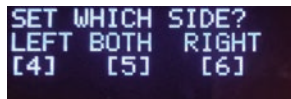

Prompt is displayed to select which Basket side is to start. Use keypad to select. **LEFT - BOTH - RIGHT**.

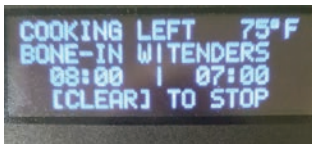

After selecting the Basket side, Controller enters **COOK** state. If the Fryer is equipped with automatic Basket Lifts, the Basket will be lowered into the cooking oil and the programmed Menu Cooking Time will begin counting down on the **7-Segment Display**. The **OLED Display** shows which side's cycle is cooking, as well as displaying the programmed setpoint temperature. If both side are cooking, the display indicates **BOTH**. The **Timer Indicator** for the timer being displayed will be illuminated.

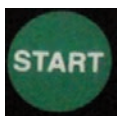

A different Cook Timer can be stated for the other Basket if desired. To start the cook cycle press the **START** key once.



Prompt is displayed to select the other Basket side. Press the appropriate arrow key **[4]** or **[6]** to start the other Timer. The **7-Segment Display** and the **Timer Indicator** will change to the timer started.



x 2

When both Timers are cooking and counting down, pressing the **TIME** key twice will swap the **7-Segment Display** between Timers. **Timer Indicator** will change to reflect the active timer.

5-01.6 Cooking Cycle, General Overview - Continued

EOF10-10, DUAL DISPLAY



The temperature **SETPOINT**, **MENU NAME**, and **COOKING TIME** currently selected are shown on the **OLED Display** of each Vat.



When in **READY** state the Temperature setpoint is shown on **7-Segment Display** of each Vat. The **READY** message indicates that the cooking oil is at proper temperature and the Vat is ready for cooking.



To start the cook cycle press the **START** key once.

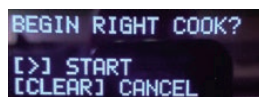

Prompt is displayed on each side for selecting which Vat to start

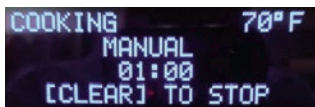

After selecting Vat, the Controller enters **COOK** state. If the Fryer is equipped with automatic Basket Lifts, the Basket will be lowered into the cooking oil and the programmed Menu Cooking Time will begin counting down on the **7-Segment Display** of that Vat. The **OLED Display** shows that the Vat is **COOKING**, as well as displaying the programmed setpoint temperature. The **Vat Timer Indicator** is illuminated.



The other Vat Timer can be stated if desired. To start the cook cycle press the **{START}** key once.



Prompt is displayed on the idle side display to select the other Vat. Pressing the appropriate arrow key **[4]** or **[6]** will start Timer. **7-Segment Display** of that Vat begins countdown.

5-01.6 Cooking Cycle, General Overview - Continued

STIR ALARM: When enabled, an audible alarm sounds at a specific time during the cook cycle, signaling the operator to stir the cooking product to help promote more even cooking. For **EOF-20 Single Display** unit, a message indicating which basket side to stir (**LEFT, RIGHT, BOTH**) is displayed. The feature must be enabled in **USER SETTINGS, Section 5-01.8** and the point in the cycle when the alarm is to sound (**STIR ALARM %**) must be set.

e.g. **STIR ALARM %** = 60 & cook cycle = 10 minutes ... alarm will sound after 6 minutes have elapsed. **Factory-set default = ENABLED with STIR ALARM % = 62.** If **STIR OVERRIDE** is set to **[FORCE]** or **[SKIP]** for the Menu Item cooking, the **STIR ALARM** functions accordingly regardless of the **USER SETTING**.

When the cooking cycle time is complete, an audible signal will sound; if Fryer is equipped with Basket Lifts, the cook Basket is automatically raised from the oil. On **EOF-20 Single Display** unit, the message **DONE COOKING - LEFT, RIGHT or BOTH** is displayed. For **EOF10-10 Dual Display** unit, message **DONE COOKING** is shown on the appropriate vat display. Pressing the **ALARM** key silences the alarm and the Fryer re-enters **READY** state, ready to cook the next load of product.



To **cancel** a running cook cycle press the **[CLEAR]** key once ... Select side or vat to cancel. Cycle time countdown stops when selection is entered.

5-01.7 Other Controller Features

5-01.7.1 Manually Operating Basket Lifts (If Equipped)

EOF-20, SINGLE DISPLAY

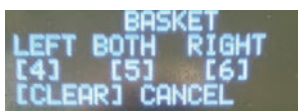
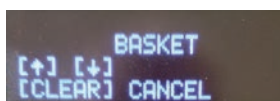

Press the **BASKET** Key once

Use keypad **[2] UP & [8] DOWN** keys for Raise or Lower Basket Lift
Press **[CLEAR]** to Cancel the operation.



EOF10-10, DUAL DISPLAY

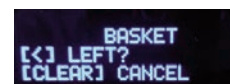
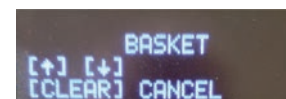

Use keypad to select side
EOF-20
[4]=LEFT [5]=BOTH [6]=RIGHT

EOF10-10
[4]=LEFT [6]=RIGHT

NOTE:

- Manual Basket Lift operation is disabled while the Controller is in **PREHEAT** state as a safeguard against operators lowering and attempting to cook product in oil that is not yet at the proper cooking temperature.
- **Lift Switch must be in [ON] position.**
- Once activated, the Lift cannot be moved again for approximately 20 seconds. Basket indicator light remains **ON** until Lift resets.

5-01.7.2 COOL Mode

COOL Mode is an energy-saving feature that automatically lowers oil temperature setpoint, allowing the Fryer to idle at a lower “standby” temperature during periods of non-use downtime. COOL mode temperature is significantly lower than cooking temp, but not so low that recovery will require too much time.

To enter COOL MODE, press the [COOL] key. The temperature setpoint will be changed to the COOL TEMP specified in USER SETTINGS; factory-set default = 275°F. The setting can be edited by the user; valid range is 200°F to 350°F; see Section 5.01.8, Edit User Settings.

EOF-20, SINGLE DISPLAY:



Press [COOL] key once.

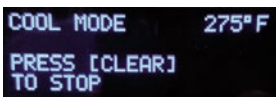

Display changes to indicate COOL Mode is in effect.

EOF10-10, DUAL DISPLAY:



Press [COOL] key once. Each Vat side can be placed into COOL Mode separately.

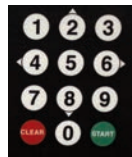
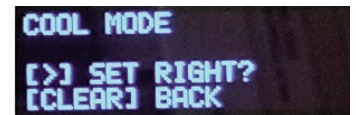
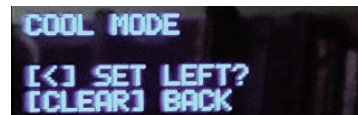

Use keypad to select Vat side
[4]=LEFT [6]=RIGHT

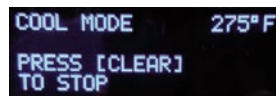

The display of the selected Vat changes to indicate COOL Mode is in effect.

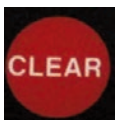

- To exit COOL Mode: press the [CLEAR] key once, then press [4] key to stop COOL Mode -OR- press [CLEAR] key again to continue COOL Mode.
- Upon exit, the temperature setpoint returns to the previous active value and Fryer enter PREHEAT until temperature is reached.

5-01.7.3 AUTO-COOL Feature

AUTO-COOL feature automatically places the Fryer into **COOL Mode** if NO cook cycles are started during an amount of time specified by a setting in **USER SETTINGS**. This feature is factory-set to **OFF...AUTOCOOL TIME default = 30 minutes**. It can be turned **ON** and time can be edited to any value within the range of **1 to 510 minutes**. See **Section 5.01.8, Edit User Settings**.

Exiting from **AUTO-COOL** is same as exiting from regular **COOL Mode**.

5-01.7.4 BOIL OUT Mode

BOIL OUT Mode is a pre-programmed cleaning cycle for the cooking Vat that can be started by simply pressing the **[BOIL]** key while the Controller is in **PREHEAT** state. Temperature and time setting change to the **BOIL TEMP** and **BOIL OUT TIME** specified in **USER SETTINGS** (see **Section 5-01.8**). Factory-setting: **BOIL TEMP = 200°F ... BOIL OUT TIME = 30 minutes**. Settings can be edited by the User within the ranges of **BOIL TEMP = 185° to 208°F ... BOIL OUT TIME = 1 to 45 minutes**.



Fryer must be in **PREHEAT** to enter **BOIL OUT Mode** ... Press **[BOIL]** key once.

- Temperature setting changes to **200°F**.
- Time setting changes to **30 minutes** and begins to countdown.
- **EOF10-10**: Both Vat sides will enter **BOIL OUT** at the same time.

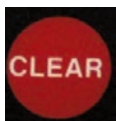

- **To exit BOIL OUT Mode:** press the **[CLEAR]** key once, then ...
EOF-20: press **[4]** key to **STOP** the **BOIL OUT** cycle.
EOF10-10: press **[4]** key to **STOP** left side ... **[6]** key to **STOP** right side.
-OR- press **[CLEAR]** again to continue **BOIL OUT Mode**.

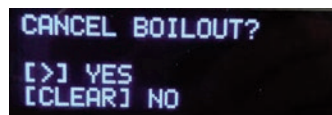
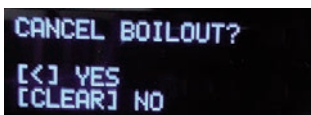

IMPORTANT! Fryer must be properly drained, rinsed and prepared for cooking after a Boil Out cycle. See **Section 6, Cleaning**.

5-01.8 User Settings - Access & Edit



+ 9999 +



Press the **TIME** key

Press the **START** key

Use numeric keypad **[4] & [6]** (left/right) to scroll through list until desired Setting is shown on the **OLED Display**.



To edit the setting press the **EDIT** key ... Use numeric keypad **[2] & [8]** (up/down) to change the value. Press **EDIT** again to save the new value.



To exit the **USER SETTINGS** menu, press the **CLEAR** key.

NOTE:

The message **TOO LOW** or **TOO HIGH** will be displayed if a value being entered is outside the allowable range and would cause a Controller error for the current state of the Fryer.

NAME	DESCRIPTION	RANGE	DEFAULT
TEMP SCALE	Temperature scale	°F or °C	°F
FORCE FILTER	When ON , forces user to filter oil after specified number of cook cycles ... locks-out unit until performed .	ON - OFF	ON
FORCE FILTER SNOOZE	Allows (1) more cook cycle after FORCE FILTER count exceeded when FORCE FILTER = ON.	ON -OFF	OFF
FILTER COUNT	Number of cook cycles before user is required to filter.	1 to 20	4
GUARD BAND	Cooking not allowed if oil temperature is outside of the setpoint by amount of guard band	1 to 990	900
MAX SETPOINT	Maximum oil setpoint allowed.	32°F to 350°F	350°
AUTOCOOL	After a specified amount of time, unit will go into COOL mode.	ON - OFF	OFF
AUTOCOOL TIME (MINUTES)	If AUTOCOOL is ON , then after fryer is idle for the amount of time specified here, the unit will go into COOL mode.	1 to 510 minutes	30
AUDIBLE ALARM (SECONDS)	Duration of the audible alarm in seconds.	5 to 120 seconds	10
COOL TEMP	Temperature of the COOL mode	200°F to 350°F	275°F
BOIL TEMP	Temperature of the BOIL OUT mode	185°F to 208°F	200°F
FILTER RESET	Temperature that allows exiting of filter mode	200°F to 325°F	290°F
BOIL OUT TIME	Time (in minutes) for BOIL OUT mode	1 to 45 minutes	30
STIR ALARM ENABLE	If enabled, allows the stir alarm to come on during a cook cycle.	ON - OFF	ON
STIR ALARM %	When STIR ALARM is ON , the alarm will sound after this % of the cooking cycle is complete.	10% to 90%	62%
KEY BEEP ENABLE	If enabled, audible sound generated with each key press.	ON - OFF	OFF

5-01.8 User Settings - Access & Edit - Continued

NAME	DESCRIPTION	RANGE	DEFAULT
LANGUAGE	Sets the Controller language	English-Spanish-French	English

5-01.9 PASSWORD Protection

It is possible to enable **PASSWORD** protection for certain Controller functions and settings. This feature is typically factory-set as **DISABLED**. When the **PASSCODE ENABLE** setting is **ON** (enabled) in **FACTORY SETTINGS**, the Controller prompts the user for a password before they can add or edit Menu Item Presets, enter a manual temperature setpoint, enter or change a manual cook time setting, or access the User Settings Menu.

If you desire to have Password protection enabled, or have questions concerning this feature, call **Giles Technical Services at 800.554.4537** to request the passcode and instructions as to how to enable this feature.

5-01.10 Power-Up Procedure

- Initially, ensure that **Heat Switch** ① is in the **[OFF]** position.
- Place **Power Switch** ② in the **[ON]** position. The green **Power Light** ③ will illuminate; Computer Cooking Controller will power-up, perform a memory check and then an audible alarm sounds. The message **POWER FAILURE [PRESS START TO PREHEAT]** is shown on the **OLED Display** ④. This is normal, intended to prevent the Fryer from beginning to heat after a power interruption until attended by an operator. Pressing the **[START]** key ⑤ silences the alarm and puts the Fryer into the **PREHEAT** state. The Temperature setpoint or any Menu Item presets shown on the **OLED Display** will be the last ones used. The Controller indicates that the Fryer is heating, but until the **Heat Switch** ① is placed in the **[HEAT]** position, the heating elements will not turn **ON**. **DO NOT** place **Heat Switch** in the **[HEAT]** position until the fry vat has been filled with cooking oil.
- See **Section 5-02, Cooking Procedures**.

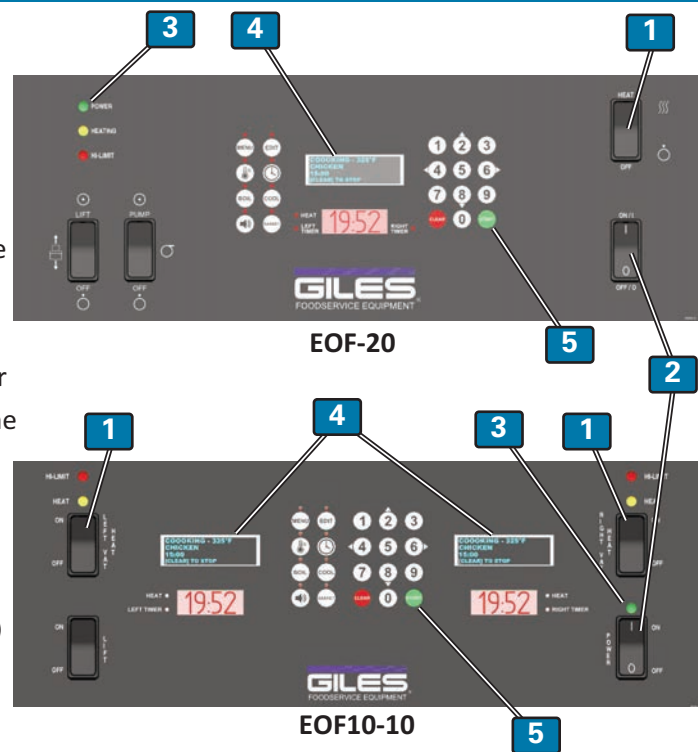

5-01.11 Controller Errors & Alarms

Certain conditions, which can cause unsafe operation or damage to the unit, such as open valves, low oil level, high temp, etc. will activate error codes and sound an alarm tone. Error Codes will show on the **7-Segment Display**; error information is shown on the **OLED Display**. Typically, the heating elements are disabled until the error condition is corrected. Pressing the **[ALARM]** key silences the alarm tone, but does not clear the error. Error Codes are shown on the following Table; details are presented in the following section.

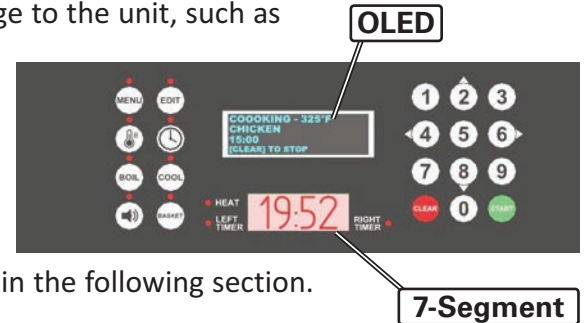

ERROR CODE	DESCRIPTION (OLED Display)	PROBLEM
OPEN	DRAIN IS OPEN	Drain valve is open, or not completely closed. Basket will be raised if it is down. Close drain to clear error.
----	CHECK OIL LEVEL, ENSURE VAT IS FULL, IF FULL THEN PRESS [START]	This is a secondary error displayed after closing drain clears the OPEN error; allows confirmation of oil level.
ER07	MAX ELEMENT TEMP – PRESS [START] (Post Warning)	Error is displayed after MAX element temperature (ER19) has occurred and the element has cooled below MAX temperature, .
ER13	OIL PROBE Error	Problem with the Variable Oil Temp Probe. Service technician required.
ER15	ELEMENT PROBE Error	Problem with the Element Temp Probe, typically attached directly to heating element. Service technician required.
ER19	MAX ELEMENT TEMP Error	The maximum heating element temperature has been exceeded. This is a safety device; NEVER bypass this Probe.
ER21	BAFFLE FILTER MISSING	Not Applicable
ER22	CHARCOAL FILTER MISSING	Not Applicable
ER23	FILTER CLOGGED	Not Applicable
ER24	EAC CELL DIRTY	Not Applicable
ER25	GUARD BAND EXCEEDED	Actual oil temperature deviates from setpoint by the Guard Band amount. Allow oil to cool, or heat, to within range. Factory default is 900°F ... Error should not occur.
ER37	EEPROM Error	An error occurred while saving settings to the EEPROM. Contact Giles Tech Service (800.554.4537).
ER38	Internal ADC Error	The ADC (Analog-to-Digital Converter) chip that reads output from thermocouples is not working. MCB1 board must be replaced. Contact Giles Tech Service (800.554.4537).

5-01.11.1 Resolving Controller Errors and Alarms

- **DRAIN OPEN (Error Code OPEN)** - If the pot Drain Valve is open (even slightly) while Fryer power is **ON**, an alarm tone sounds, 7-Segment Display shows **OPEN**, and the **OLED Display** reads “**ERROR ALARM - DRAIN IS OPEN**”. If the Basket Lift is down, it will be raised. Heating Elements are disabled as long as the condition exists. Press the **[ALARM]** key to silence alarm tone. Completely close the Drain Valve to clear the error. When error is cleared, alarm tone sounds again and the OLED Display reads “**CHECK OIL LEVEL, ENSURE VAT IS FULL, IF FULL THEN PRESS [START]**”. This is a post-error alarm to alert user to confirm that cooking oil in the pot is still at the **FULL** level. Add oil if needed, then press the **[START]** key to return to **PREHEAT** mode.
- **MAX. ELEMENT TEMP (Error Code 19)** - Heating Element has exceeded the maximum temperature allowed by the Controller. The alarm tone sounds, 7-Segment Display shows **Er19**, and the OLED Display shows “**ERROR ALARM - MAX ELEMENT TEMPERATURE**”. Heating Element is automatically turned **OFF**. It must cool to an acceptable temperature to clear the error. Typical cause of this error is low oil level, which has exposed the heating element. It is possible for a false alarm to occur when preheating cold oil at the initial startup of a new day. Vigorously stirring oil during preheat will usually prevent, or clear, a false alarm of this type.
- **MAX ELEMENT TEMP Post-error Warning (Error Code 07)** - After **Error 19** is cleared, a warning alarm occurs. The 7-Segment Display shows **Er07**, and the OLED Display reads “**MAX ELEMENT TEMP - PRESS [START]**”. This alarm alerts user that a maximum element temperature error occurred and is now cleared. Press **[START]** key to enter **PREHEAT** mode. Heating Element will not turn **ON** until **[START]** is pressed.
- **BAFFLE FILTER MISSING (Error Code 21) - Not Applicable**
- **CHARCOAL FILTER MISSING (Error Code 22) - Not Applicable**
- **CLOGGED FILTER (Error Code 23) - Not Applicable**
- **E.A.C. DIRTY (Error Code 24) - Not Applicable**

NOTE: If an error condition cannot be resolved, please contact a factory-authorized service agent, or call 800.554.4537 for Giles Technical Support.

5-02. Cooking Procedures

This section describes procedures for cooking product on the EOF Series Fryers. Procedures presented assume beginning with a clean empty Fryer.

1. Set the cooking oil temperature to a desired setpoint; see **Section 5-01.3, Manually Setting the Cooking Temperature**, or select a desired Menu Item preset; see **Section 5-01.5.1, Selecting a Menu Preset**.

For the EOF-20 Fryer unit, the cooking temp must be set manually.

2. Ensure that the Power Switch ① is in the OFF position.
3. Ensure that the Heat Switch ② is in the OFF position.

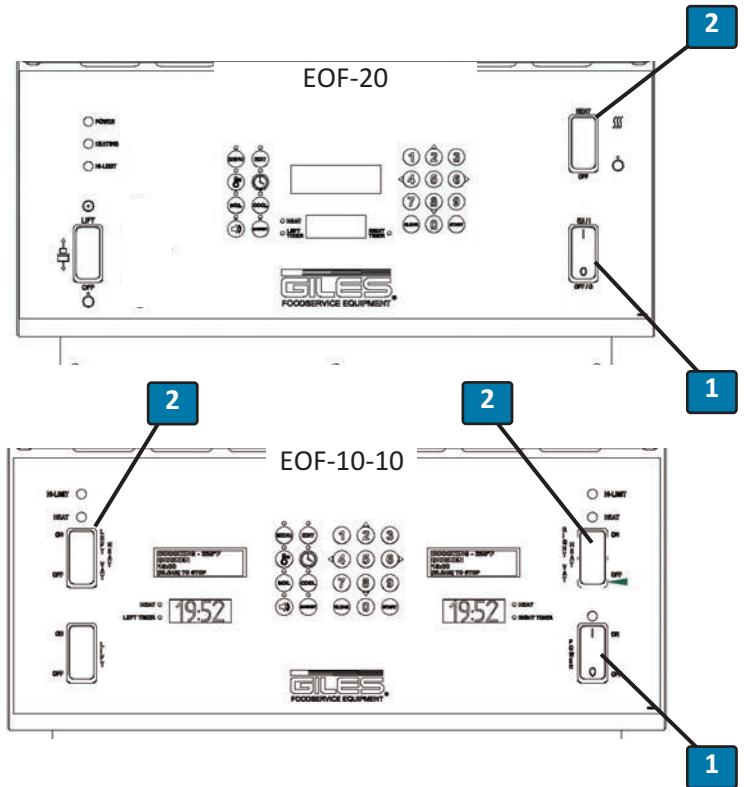

4. Be sure Drain Valve Handle ③ is pushed in and locked in the **CLOSED** position (**tab on Handle is through panel opening and tucked securely behind**).
5. Fill the Fry Vat with liquid frying shortening. Fill only to the **ADD** mark ④ at this time to allow for expansion as oil is heated to cooking temperature.

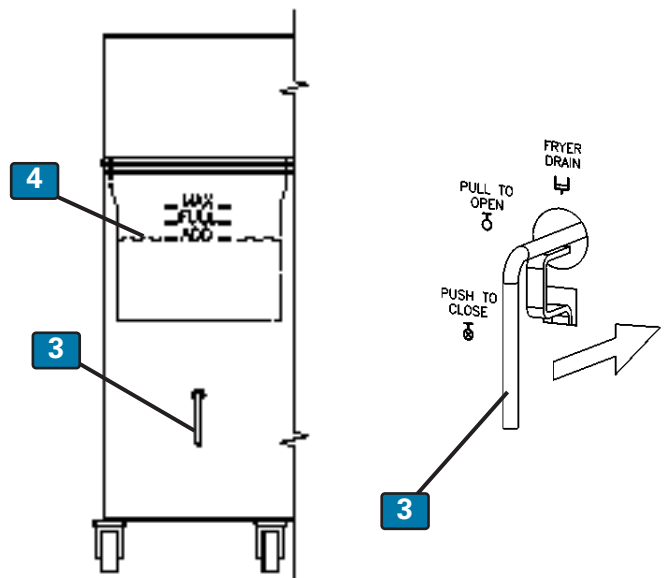

Continued on Next Page

5-02. Cooking Procedures - Continued

- Set the Power Switch **1** to the **ON** position. The Power Light **5** will turn on. If the Fryer unit is equipped with Basket Lifts, and if User wants to enable them, place the Basket Lift Switch **6** in the **LIFT** position. **If Lifts are not installed, there is no Lift Switch.**

NOTE:

If an alarm sounds when Power Switch is placed in the **ON** position and **OLED Display 8** shows the message **ERROR ALARM DRAIN IS OPEN**, verify that the Drain Valve is tightly closed and press the **[ALARM] Reset key 10**, and/or follow Controller prompts.

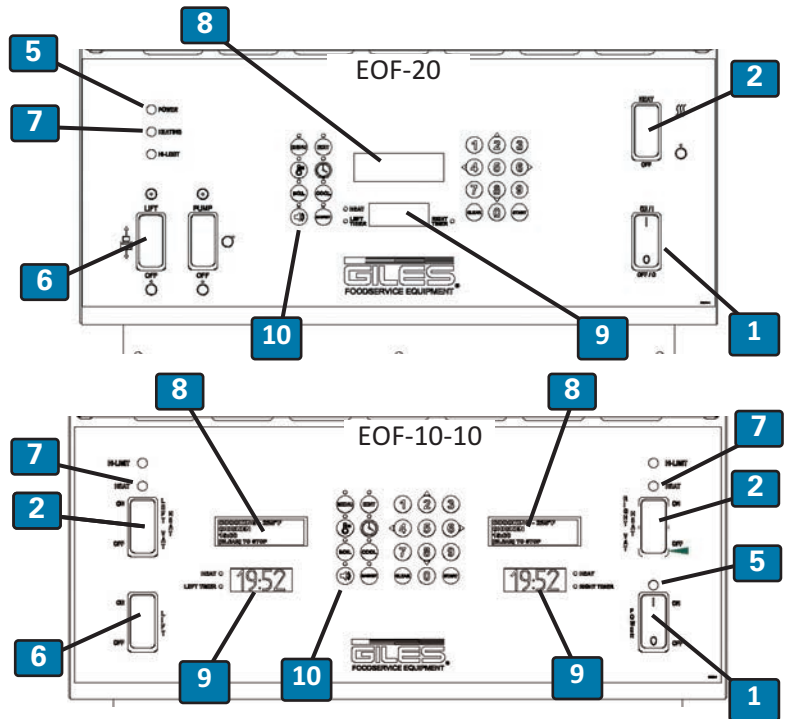

- Place Heat Switch **2** in the **HEAT/ON** position; the Heat Light **7** will illuminate and oil should begin heating. The **OLED Display 8** will show **PREHEATING** and the **7-Segment Display 9** shows the real-time oil temperature as heating occurs.



Cooking oil will be extremely HOT! Always wear thermal protection, such as oven mitts, when stirring hot oil.

- It is recommended that the oil be stirred occasionally while heating to prevent occurrence of false **HI-LIMIT** or **MAX ELEM TEMP** alarms. This is especially important during the initial heat-up of the day, when shortening is in a cool thickened state.
- When cooking oil reaches the programmed setpoint, an alarm sounds and the **OLED Display 8** reads **ALARM STIR OIL**. Press the **[ALARM] key 10** and vigorously stir the oil. There is a 10 second delay; if temperature drops below setpoint while stirring, the Controller remains in **PREHEAT** until setpoint is reached again, alarm sounds again and the **OLED Display** reads **ALARM SETPOINT REACHED**. Press the **[ALARM] key** and Controller enters **READY** state.

Cooking oil should now be evenly heated and ready for cooking.

5-02. Cooking Procedure - Continued

10. Check the oil level, it should now be at the **FULL** Mark (11). Add shortening if needed and stir in. If the **HEAT** light turns **ON** after adding additional oil, continue stirring until it turns **OFF** again before cooking.

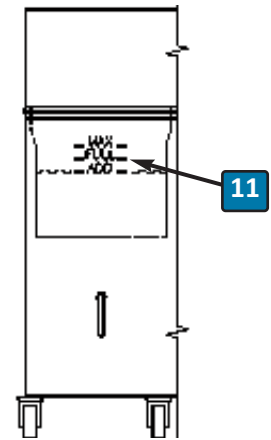

11. Place the Fry Screen (12) into vat with the handles to the side.

12. If Basket Lift option is installed, place the Cooking Baskets (13) onto the Basket Carriers (14), otherwise hang baskets on Hanger Bars.

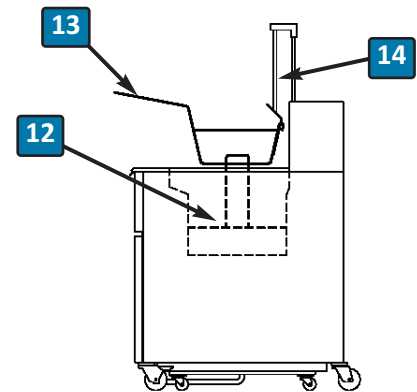

NOTE: Basket Lift Models:

If not desiring to use the Basket Lifts, move Lifts to the **UP** position and use the Basket Carrier as a hanger.

WARNING

During cooking operations, oil level **MUST** be maintained above the indicated minimum (ADD) level. If not maintained above that level the heating elements may shutdown.

5-02. Cooking Procedure - Continued

13. It is recommended that uncooked product be placed into the Cook Basket before being placed into the hot oil, whether on a Basket Lift, or hanging on the Basket Hanger. When Fryer is equipped with Lifts, Basket is automatically lowered into hot oil when cook cycle is started.

Uncooked product may also be placed into the Basket after it is in the oil. Some Users prefer to use a batch cooking method for high-volume operations. In those cases, no Baskets are used. Product is dropped directly into the oil and removed with the provided scoop-type basket when done cooking.



Use extreme caution when dropping product into HOT cooking oil! There is potential for severe burn injury should unprotected hands contact hot oil, or should an unexpected splash occur. Introducing overly wet food items or larger than recommended load sizes into the cook vat can lead to a surge boil, resulting in an overflow of HOT cooking oil. Exercise due caution when loading food and observe how the hot oil reacts before continuing.

- 14. If using Lifts, and if necessary, raise them to the full **UP** position, see **Section 5-01.7.1, Manually Operating the Basket Lifts**. Position Cook Baskets as needed, on Basket Lift carriers or hanger bars.
- 15. Select a desired Menu Item Preset, or manually enter a desired cooking time for the specific product. See **Section 5.01.5.1, Selecting a Menu Preset** or **Section 5.01.4, Setting a Manual Cook Time**.
- 16. Load product in the Cook Basket(s). Confirm that Fryer is in **READY** state before continuing.

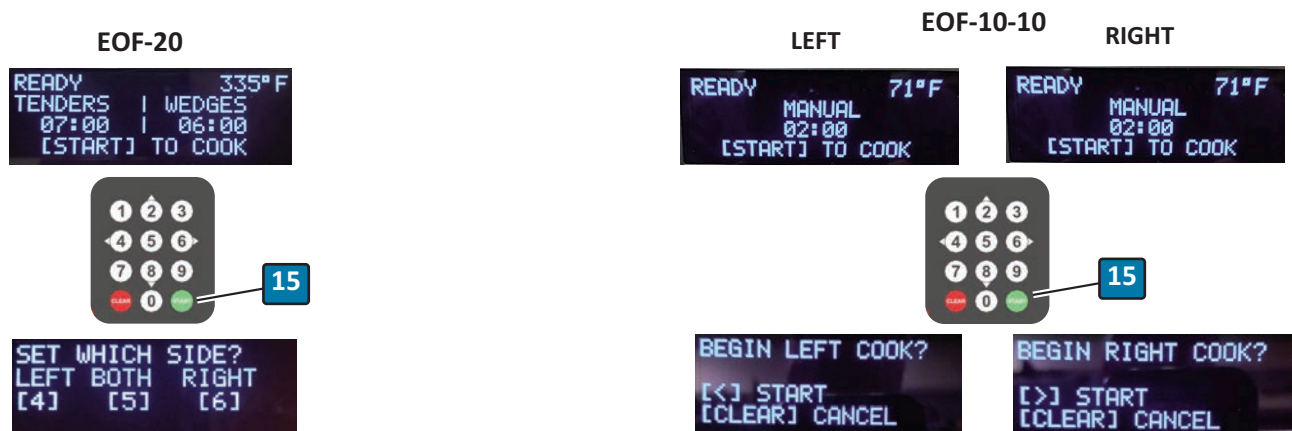

17. Press **[START]** key **15**. For **EOF-20**, use keypad to select which Basket side to begin cooking; **[4]=LEFT**, **[5]=BOTH** or **[6]=RIGHT** ... for **EOF10-10**, select Vat side to start; **[<4]=LEFT**, **[>6]=RIGHT**. Cooking settings for both Basket sides are shown on the **EOF-20 Single Display** ... **EOF10-10 Dual Display** shows setting for each Vat side. Timer begins as soon as side selection is made.

Place Baskets containing product into cook vat; manually placed baskets rest on Fry Screen **12**. When using Lifts, cook Basket(s) will automatically be lowered into vat. The programmed cook time begins to count down, shown on the **7-Segment Display**.

18. The **OLED Display** of the **EOF-20** will show which side (left, right or both) is **COOKING** ... The appropriate vat display on the **EOF10-10** will indicate **COOKING**. The **7-Segment Display** shows the cook cycle time remaining and counting down.

Continued on Next Page

5-02. Cooking Procedure - Continued



Always wear thermal protective gear, such as oven mitts, when handling hot Baskets.

19. If the **STIR ALARM** feature is enabled (see **USER SETTINGS**), after a preset amount of the programmed cook time has elapsed, an alarm sounds and the **OLED Display** on **EOF-20** reads **ALARM STIR LEFT/RIGHT/BOTH SIDE ...** on **EOF10-10** each side displays separately. Press the **[ALARM]** key **(17)** and using the provided stirring utensil **(16)** stir the cooking product. If using Basket Lifts, be sure that basket does remain hooked to the Basket Carrier.

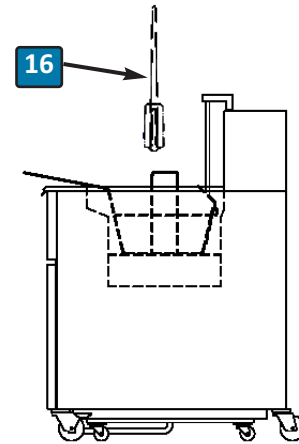

20. When programmed cook time has elapsed, an alarm will sound. **EOF-20**: the **OLED Display (18)** will read **ALARM DONE COOKING - LEFT/RIGHT/BOTH ...** **EOF10-10**: displays **(18)** will read **ALARM DONE COOKING - LEFT (or RIGHT)** as appropriate. If Lifts are installed, cook Basket(s) will automatically be raised from the hot oil. Press the **[ALARM]** key **(17)** to silence alarm.

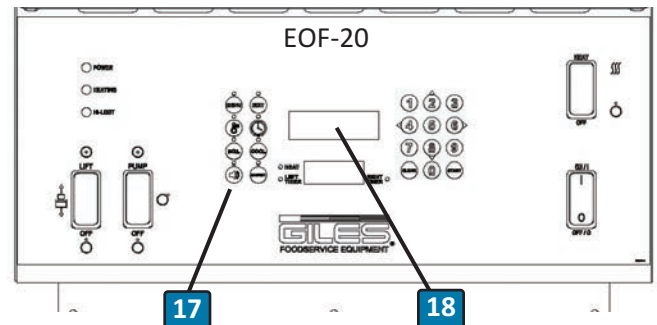

21. As necessary, remove Baskets with cooked product from vat, or Basket Carrier, and dump into an appropriate hot food pan with drain grate.

If batch cooking a large quantity of product, use the provided scoop-type basket to dip cooked product from oil.

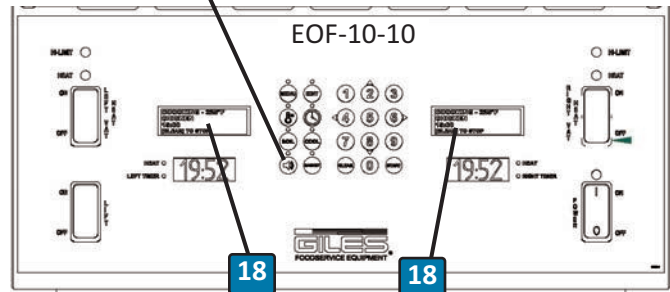

23. After allowing product to adequately drain and while it is still hot, place into food pan and move to heated display case.

23. To continue cooking return to **Step-10**.

To shut-down unit, see **Section 5-07, Normal Shut-Down**.

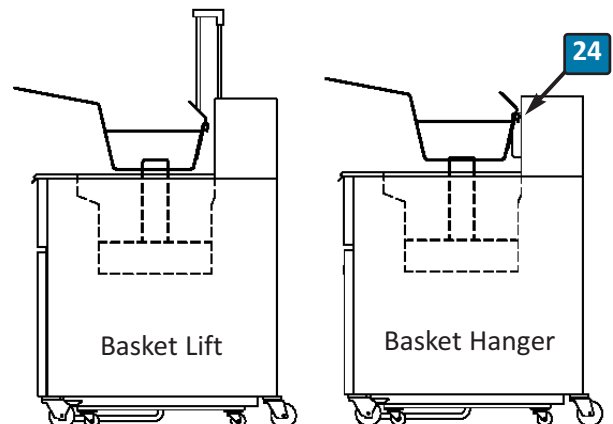

5-03. Filtering Used Cooking Oil

This section explains use of the built-in Filtration System, which filters and reconditions used cooking oil by circulating it through filter media in the Filter Pan and back to the fryer vat. Following this process can increase oil life by as much as 50%.

The Computer Controller is programmed with a **FORCE FILTER** feature which places the Fryer into **FILTER MODE** after a certain number of cook cycles are completed and forces User to perform the filtering cycle. When enabled, this feature locks out the Fryer unit until a filter cycle is performed. By default, this feature is turned **ON** and the **cycle COUNT is set to 4**. It can be turned **OFF**, or the **COUNT** can be changed to a value in the range **1 to 20**. See **USER SETTINGS, Section 5-01.8**.

A **FORCE FILTER "SNOOZE"** feature can allow one (1) additional cook cycle after the force filter count is exceeded. The default is **OFF**; it may be enabled in **USER SETTINGS, see Section 5-01.8**.

CAUTION Never attempt to perform the filter process when shortening is cold. Doing so can clog the filter pump and damage the unit. Oil must be heated to at least 200°F (93°C) for filtering. Always wear thermal protective gear, such as oven mitts, while performing the filtering process. Fryer parts inside the cabinet will be extremely HOT!

1. It is recommended that oil be filtered after every fourth (4th) load has been cooked ... **Force Filter** is factory set **ON** to enter **Filter Mode** after 4 cycles.
2. Place the Heat Switch ① of the unit requiring filtering in the **OFF** position.
3. Open the right Cabinet Door. Wear thermal hand protection and disconnect the Filter Pan hose ② by pushing in on the white slip-ring while pulling the hose from connector. Remove Filter Pan ③ from unit.
4. **If using Filter Paper:** Ensure that (1) sheet of Filter Paper is installed correctly in Filter Pan and that Hold-down Frame is securely locked in place.
If using Renewable Mesh Screen: Ensure the Screen is free of residue and properly seated in the Filter Pan bottom. Be certain that no debris is trapped underneath the gasket and that Hold-down Frame is securely locked in place.
5. Add approximately 5 oz. of a suitable Filter Powder (**available from Giles, P/N 72004**), distributing evenly over the filter media surface. Use of a good quality filter aid is important for removing soluble impurities and reconditioning the oil.
6. Replace Cover ④, reposition Pan under unit and reconnect Filter Pan hose by pushing in slip-ring while inserting brass hose fitting in connector. Ensure fit is tight and secure.

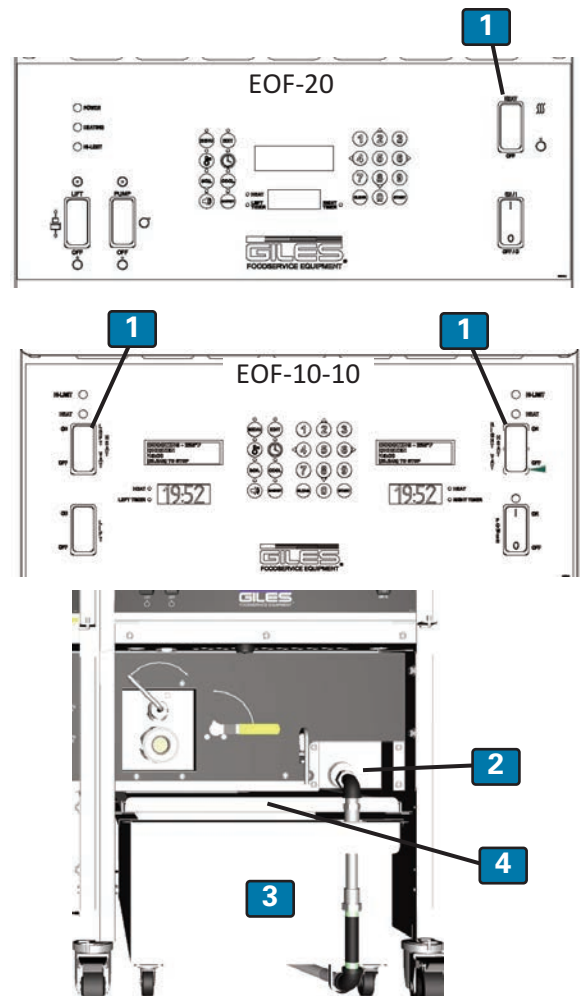

Continued on Next Page

5-03. Filtering Used Cooking Oil - Continued

⚠ DANGER During the next steps cooking oil is drained from the vat, exposing the heating elements. Even though safety interlocks are in place, failure to place the HEAT Switch in the OFF position before draining could result in fire. **ALWAYS CONFIRM THAT THE HEAT SWITCH IS IN THE OFF POSITION BEFORE DRAINING THE COOK VAT.**

⚠ WARNING

- Never drain more than one (1) vat at a time into the Filter Pan! The pan only has capacity to hold the oil from one (1) cook vat.
- Never disconnect and attempt to remove the Filter Pan from unit while it contains cooking oil.

7. Confirm that **HEAT** Switch for the unit being filtered remains in the **OFF** position. Inside the **Right-side Cabinet** ensure the Pump Discharge Valve Handle (5) is in the **TO FRYER VATS** position. **On the unit being filtered**, unhook and slowly pull Drain Valve Handle (6) out to the **OPEN** position. The cooking oil should begin draining into the Filter Pan.



NOTE:
If the oil does not readily drain, use the provided Drain Brush, or Clean-out Tool, to break up crumbs or residue that might be blocking the vat drain opening.

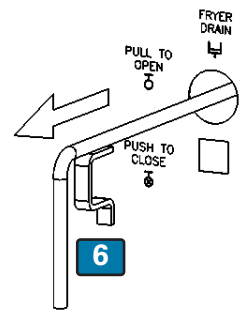

8. On the Fryer unit being filtered, set the Oil Return Valve handle (7) to the **VAT FILL** position. **Oil Return Valves on all other vats MUST be in the CLOSE position.**

9. When oil has completely drained into the Filter Pan, set the Pump Switch (8) on the EOF-20 Control Panel to the **ON** position.

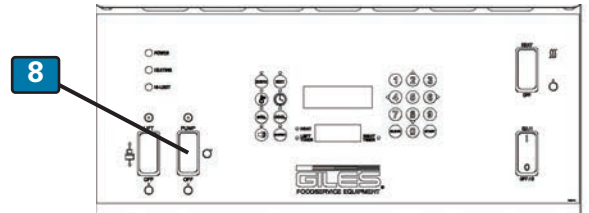
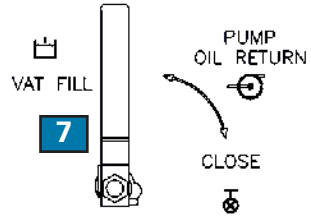

Continued on Next Page

5-03. Filtering Used Cooking Oil - Continued

10. Used cooking oil will begin to circulate **9** through the filter media in the Pan and return to the fry Vat. Leave the Drain Valve open to allow oil to continually circulate through the system for about 5 minutes. During this time, remove the Crumb Screen from the Vat and use the various provided brushes to scrub the vat walls and heating elements, allowing residue to be flushed into the Filter Pan.

11. After about 5 minutes, replaced the Crumb Screen if removed, push in and lock the Drain Valve Handle **10** in the **CLOSED** position and allow the Vat to refill. When all oil has been pumped back to the vat, air bubbles will appear at the pump discharge inside the vat.

12. After the Vat has refilled, place the Pump Switch **11** in the **OFF** position.

13. Position the Pump Oil Return Lever **12** on the unit being filtered to the **CLOSE** position.

14. Be sure the Fry Vat contains the proper level of cooking oil ... add if needed.

15. Fryer unit should now be ready to **PREHEAT** back to the Controller setpoint temperature. If **FORCE FILTER** is **ON**, the unit will remain in Filter Mode until the registered actual oil temperature drops below **275°F**. Typically, the filtering process will reduce oil temperature sufficiently to reset the Filter Mode lockout.

15. To continue cooking, See **Section 5-02, Cooking Procedure**.

To discontinue cooking, See **Section 5-06, Normal Shut-Down**.

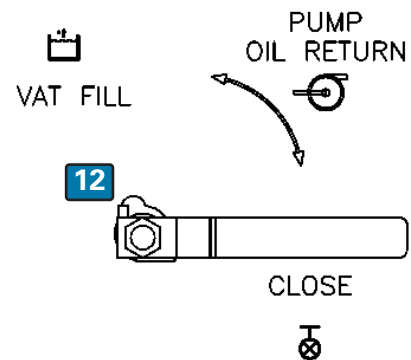
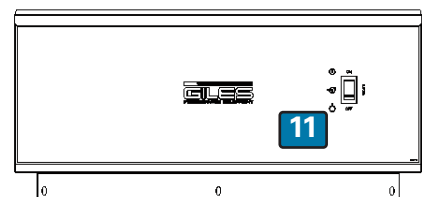
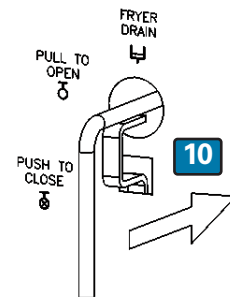
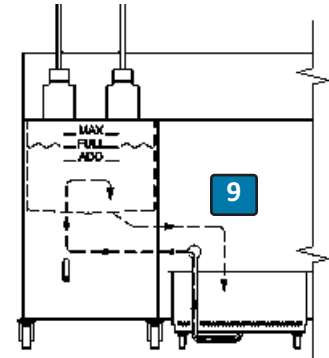

5-04. Removal of Waste Cooking Oil from Fryer

This section explains the procedure for removing used cooking oil from Fryer for disposal. Oil must be removed before a Boil-Out procedure can be performed. In this section a Giles Oil Caddy (**not included**) is depicted for oil disposal; any suitable disposal system can be used.

CAUTION

Never attempt to pump cold shortening. Doing so can clog the filter pump and damage the unit. Oil must be heated to at least 200°F (93°C) before attempting to pump.

1. If cooking oil is cold, heat to at least 200°F (93°C).
2. Ensure the Power Switch ① is in the **ON** position.
3. Confirm that the Heat Switch ② is in the **OFF** position.
4. Be sure the Filter Pan ③ and the Filter Pan Cover ④ are in place. Confirm the quick-disconnect hose ⑤ is properly connected the to unit. Verify the Pump Discharge Valve Handle ⑥ inside right-hand Cabinet is in the **TO FRYER VATS** position.

DANGER

During the next steps cooking oil is drained from the vat, exposing the heating elements. Even though safety interlocks are in place, failure to place the HEAT Switch in the OFF position before draining could result in fire. **ALWAYS CONFIRM THAT THE HEAT SWITCH IS IN THE OFF POSITION BEFORE DRAINING THE COOK VAT.**

WARNING

- Never drain more than one (1) vat at a time into the Filter Pan! The pan only has capacity to hold the oil from one (1) cook vat.
- Never disconnect and attempt to remove the Filter Pan from unit while it contains cooking oil.

5. Slowly unlock and pull the Drain Valve Handle ⑦, of the Fryer unit being serviced, to the **OPEN** position and allow the oil to completely drain into the Filter Pan.

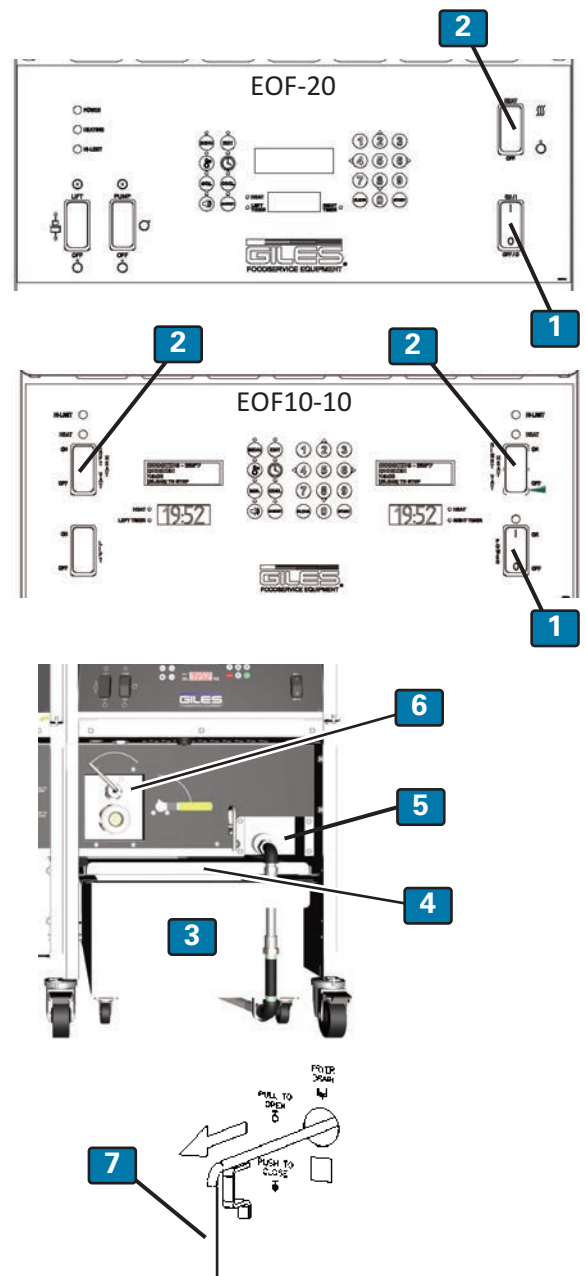

Continued on Next Page

5-04. Removal of Liquid Shortening (Continued from previous page)

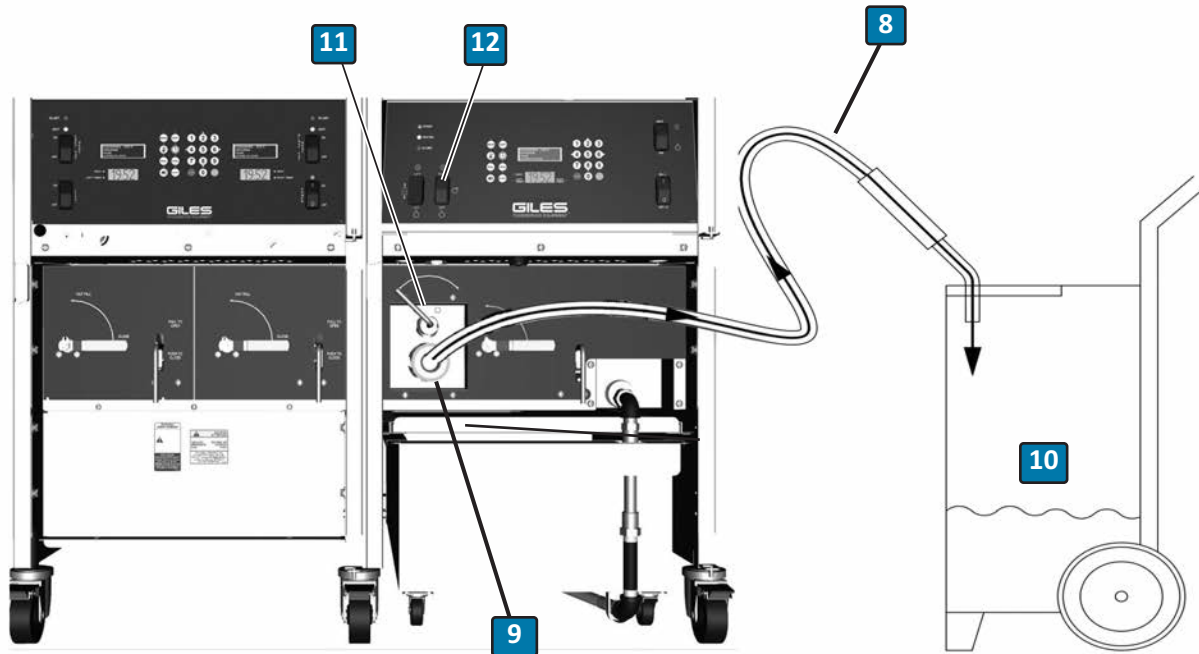

6. Connect the supplied Oil Discharge Hose (8) to the Discharge Hose Coupling (9).
7. Place the discharge end into an appropriate hot waste oil Disposal Container (10) (Giles Oil Caddy is shown)
8. Place the Pump Discharge Valve Handle (11), inside the right-hand Cabinet, in the **TO DISCHARGE HOSE** position.

WARNING

If holding the Discharge Hose during the next step, be sure the wear thermal hand protection mitts. Some parts of the hose assembly can become very hot.

9. Place the Pump Switch (12) in the **ON** position. Allow the pump to run until all liquid shortening has been pump into the waste oil Disposal Container.
10. After all the used oil has been removed from the Filter Pan, return Pump Switch to the **OFF** position.

5-04. Removal of Waste Cooking Oil from Fryer - Continued

- 11. Place the Power Switch (13) in the **OFF** position.
- 12. Push the Drain Valve Handle (14) to the **CLOSED** position, tuck tab behind panel.
- 13. Place the Pump Discharge Valve Handle (15), inside the right-hand Cabinet, in the **TO FRYER VATS** position.

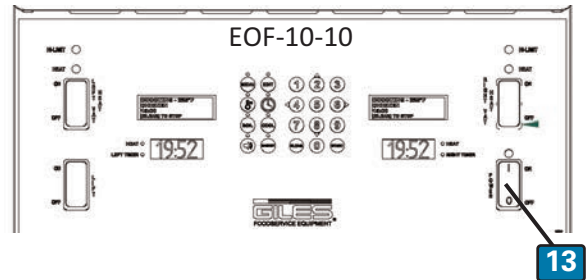
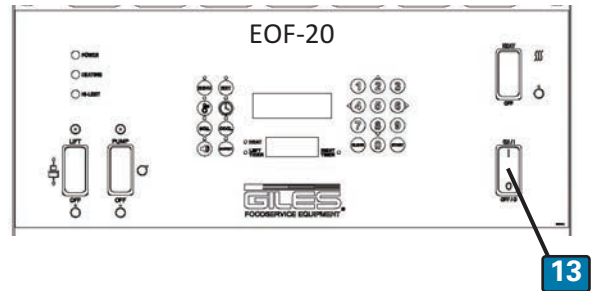

WARNING

When performing the next steps be sure to wear thermal protective gear, such as oven mitts. Some parts of the Discharge Hose assembly and coupling will become very hot.

- 14. Remove the Discharge Hose from the Discharge Hose Coupling and drain any remaining oil into the waste oil Disposal Container.
- 15. Allow the Filter Pan to cool. Remove and thoroughly clean the Filter Pan and Filter Pan Cover.
- 16. To perform a Boil Out on the unit see **Section 6-01, Boil Out Procedure**.

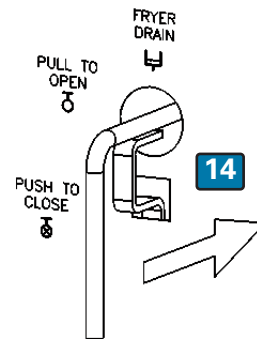

To shut down the unit see **Section 5-06, Normal Shut-Down**.

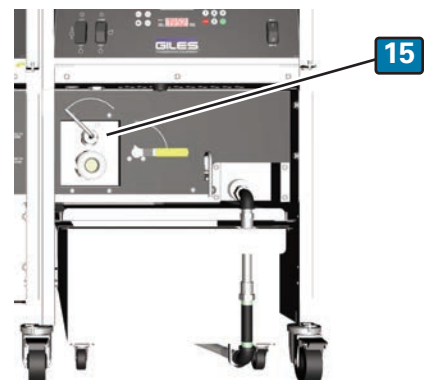

5-05. Using the Optional Stainless Filter Media Screen (SSFS)

This section describes use and care of the renewable, stainless steel, Filter Screen (SSFS). The SSFS is a direct replacement for paper filter media that can be cleaned and reused many times. It is an optional item (**Giles #41017**) that can be ordered with new units, or purchased later as a filter paper alternative.

1. Place the SSFS into the Filter Pan same as filter paper. **DO NOT use filter paper and the Screen at the same time.**
2. Be sure that the edge gasket is flat against Pan bottom. Position the Hold-down Frame and lock into place with the locking levers. Levers may not fully close when using the Screen ... this will not affect performance.
3. For best filtering results, always use an appropriate filter aid, such as **Giles #72004 Filter Powder**. Distribute the prescribed amount evenly over the surface, same as with filter paper.
4. After performing a regular filtering cycle, see **Section 5-04, Filtering Used Cooking Oil**, clean accumulated filter sediment from the SSFS surface with the supplied Crumb Shovel, or other suitable utensil, and discard. It might be necessary to remove the Screen to brush remaining residue from its surface.
5. If Screen is removed, do not allow filter residue to fall into the Filter Pan bottom and be sure to wipe any residue from the edge gasket. Reinstall screen with the soiled side up.



5-05.1 Cleaning the Stainless Filter Screen Media (SSFS)

1. It is not necessary to wash the SSFS Filter Screen after every filtering cycle.
2. On a weekly basis, remove the SSFS Screen and clean it in a sink, using **ONLY** hot water and a soft bristle brush. **DO NOT USE SOAP or OTHER CLEANERS** when washing the Screen. Doing so may affect oil life and quality. Soap residue cannot be completely rinsed from the screen, and it will eventually be transferred to cooking oil during subsequent filter cycles.
4. **DO NOT USE OVEN CLEANERS or CAUSTIC PRODUCTS** to clean the Screen. These chemicals will damage the silicone edge gasket, and residue will be transferred to cooking oil.
5. Before reinstalling the clean SSFS in the Filter Pan, shake off excess water and dry with a clean towel. Be certain screen is completely dry before using. If possible, it is best to allow screen to dry overnight.
6. Take care not to cut or tear the silicone edge gasket. Inspect the Screen weekly for damage, such as fraying, holes, damaged gasket, etc. A damaged screen should be removed from service and replaced immediately.



5-06. Normal Shut-Down

This section explains the process of shutting down the Fryer.

1. Set Heat Switch **①** on all Fryers to **OFF** position.
2. Place Power Switch **②** on all Fryers in the **OFF** position. Green Power lights will turn **OFF**.
3. If required, turn off supply power to each Fryer unit at the main electrical panel.

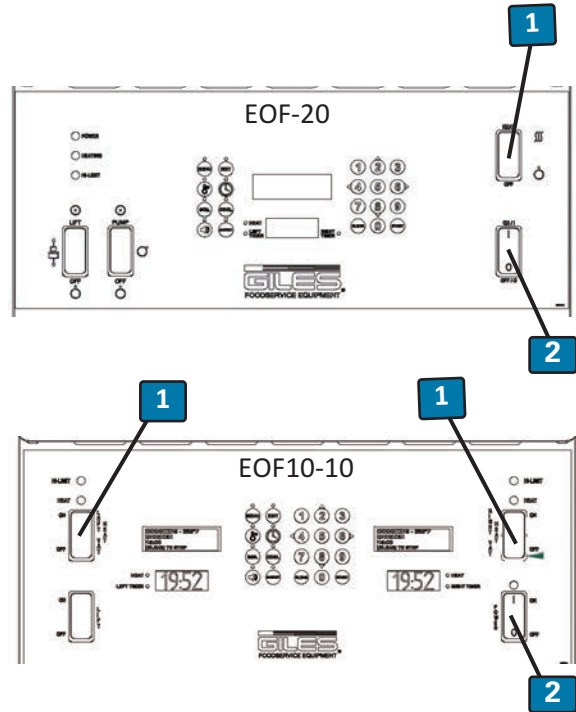

5-07. Emergency Shut-Down

In case of emergency, remove supply power to the unit by switching off main circuit breakers or disconnects within the building.



Notes:



6. Cleaning

This section explains cleaning procedures for the EOF Model Banked Fryers. General cleaning should typically be performed daily, other specific procedures should be performed as stated.

⚠ DANGER

- **DO NOT** wash down the interior or exterior of the unit with water from a spray hose.
- Failure to comply with these DANGER notices will result in death or serious injury, equipment or property damage, and void the warranty.

6-01. Boil-Out Procedure (Cleaning a Fry Vat)

This section explains how to clean the Fry Vats; this process is referred to as Boil-Out. The Boil-Out process must be performed before the first use of new equipment, and should be performed each time after disposing of used cooking oil, prior to refilling the vat with fresh oil.

For proper fryer maintenance and operation, the Boil-Out procedure should be performed every 7 to 14 days.

⚠ DANGER

DO NOT, under any circumstances, leave the fryer unattended during this procedure. It may become necessary to adjust heat settings to avoid vat overflow. Overflow may result in serious equipment damage.

1. Remove shortening from the unit, see **Section 5-05, Removal of Waste Cooking Oil from Fryer**.
2. Ensure the Drain Valve Handle **①** is pushed in and locked in the **CLOSED** position and the Power Switch **③** is in the **OFF** position.
3. Fill the Fry Vat with clean water to the **FULL** level mark **②** (both vats of the EOF10-10 fryer).
4. Follow the use instructions of the Fryer Cleaner product being used, add the recommend amount of product to water and stir to mix. **Boil-Out Cleaner** is available from Giles, part number **72003** (case of 4, 8-lbs containers), or **72003-1** (single 8-lb container).

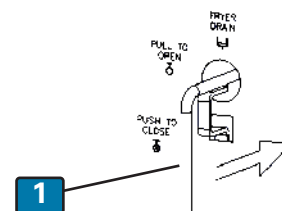
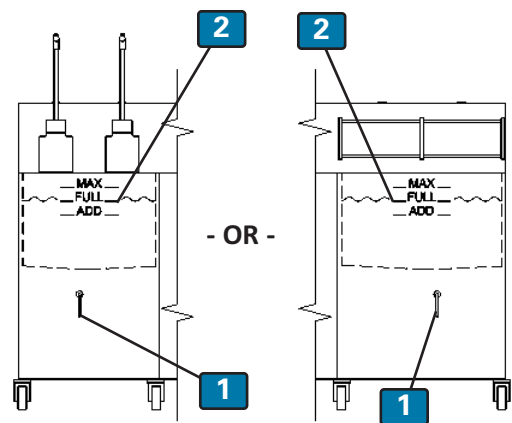

⚠ CAUTION

Closely adhere to the cleaning product manufacturer's usage instructions. Many commercially available fryer cleaners contain caustic chemicals and require special precautions when used. Improper use, may damage the fryer, and also present potential for personal injury. Always wear rubber gloves when working with clean solution.

Continued next page

6-01. Boil Out Procedure - Continued

5. Place the Power Switch (3) in the **ON** position and proceed through power-up, see **Section 5-01.10, Power Up Procedure**.
6. Place the Heat Switch (4) in the **HEAT** or **ON** position.
7. When the fryer enters **PREHEAT**, press the **[BOIL]** key (5). The Controller enters **BOIL OUT MODE**, temperature setpoint changes to **200°F**, and cycle time begins to countdown from **30 minutes**. Boil-Out solution will begin to heat. On **EOF10-10**, both Vat sides will begin Boil Out simultaneously.

NOTE: If a different boil-out temperature or time is required, the settings can be changed in **USER SETTINGS, Section 5-01.8**. **BOIL TEMP** is variable between **185° - 208°F**. **BOIL OUT TIME** is variable between **1 - 45 minutes**.

CAUTION DO NOT allow a “rolling boil”, which can result in overflow and cause damage to the unit and possible personal injury. Rolling boil is not necessary to achieve the cleaning action. Follow directions for the cleaning product being used.

8. At the completion of the Boil-Out cycle time, an alarm sounds and the **OLED Display** shows the message **DONE COOKING**.
9. Press the **[ALARM]** key (6).
10. Return the Power Switch (3) and the Heat Switch (4) in the **OFF** position.

WARNING NEVER drain boil-out solution into the Filter Pan or run it through the filter system using the Filter Pump. The solution is caustic and will damage the pump and other components. Doing this will void the warranty!

11. Position a suitable **Heat Resistant Container (7)** (not supplied) beneath the Fryer Drain. **IMPORTANT!** General purpose plastic containers are typically not suitable as they may break or melt, resulting in spillage.
12. Unlock and slowly pull the Drain Valve Handle (8) to the **OPEN** position.

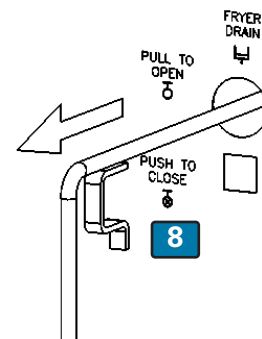
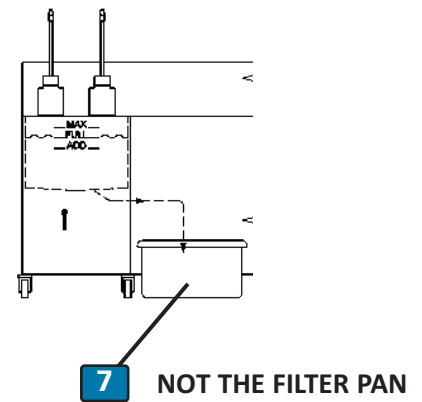
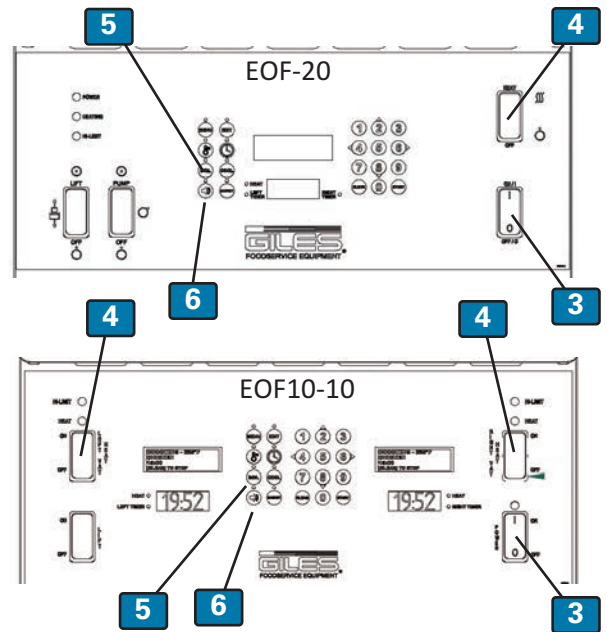

Continued next page

6-01. Boil Out Procedure - Continued

13. Remove Screen from the vat and, as needed, use Pot Brush & Element Brush to scrub residue from vat sides, bottom, and the heating elements. Rinse and flush the Vat thoroughly with clean warm water. **Note: Take care to avoid damaging the temperature probes located inside the vat and attached to heating elements. IMPORTANT! While draining and rinsing Vat, give close attention to the catch container to avoid overflowing ... empty container as necessary.**

14. Completely dry vat and heating elements with a clean dry towel and properly dispose of the used boil-out solution.

15. Push in and lock Drain Valve Handle (8) in the **CLOSE**.

16. Clean Filter Pan and replace Filter Media. See directions in **Section 6-02, Cleaning the Filter Pan & Replacing Filter Media After Boil Out.**

17. Re-install Filter Pan Cover (9).

18. Position Filter Pan (10) under unit and connect Filter Pan quick-disconnect hose to unit (11).

19. Restart the fryer for cooking. See **Section 5-03, Cooking Procedure.**

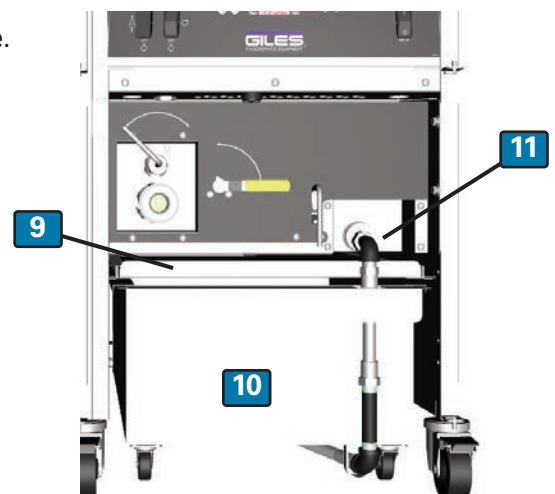
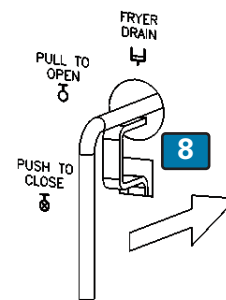

6-02. Cleaning the Filter Pan & Renewing Filter Media

This section explains the procedure for cleaning the Filter Pan and refreshing the filter media - either reusable mesh screen (SSFS) or disposable filter paper. At a minimum, this cleaning should be performed **once per day of operation**, and each time a Boil-Out procedure (**Section 6-01**) is performed.

CAUTION Wear thermal protective gear to protect hands from potentially hot parts.

NOTE: Unless otherwise instructed, all parts can be cleaned with warm soapy water or a mild, biodegradable degreaser, such as Simple Green®. After cleaning parts should be thoroughly rinsed with clean water and completely dried.

1. With Filter Pan removed from Fryer, remove and clean Crumb Screen (1), if being used.
2. Use the supplied metal **Crumb Scoop** to remove as much of the accumulated filter sediment as possible from the filter media surface, particularly around the edges. This will help prevent debris from falling through the perforated support screen and potentially causing the filter pump to clog.
3. Remove and clean the **Filter Pan Cover** (2). Dry thoroughly.
4. Turn the four Levers (4) to disengage the **Hold-down Frame** (5). Remove, clean and dry Frame thoroughly.
5. Remove the soiled **Filter Media** (6), either **Paper or Mesh Screen (SSFS)**.

Paper: Carefully roll up soiled sheet and discard; avoid allowing filter debris to fall through the permanent perforated support screen (7) in the Filter Pan bottom.

SSFS Screen: Remove the screen; avoid allowing filter debris to fall through the permanent, perforated support screen (7) in the **Filter Pan** bottom. Using only hot water and a soft bristle brush, clean **Screen** in sink. Shake out water and dry with clean dry towel. Screen must be completely dry before re-installing in **Filter Pan**.

DO NOT use soaps or cleaners of any kind for washing the Filter Screen!

6. Thoroughly clean and dry the Filter Pan (8). Flush out any debris that may have fallen through the perforated support screen. Be sure to drain all water from the **Filter Pan** piping.

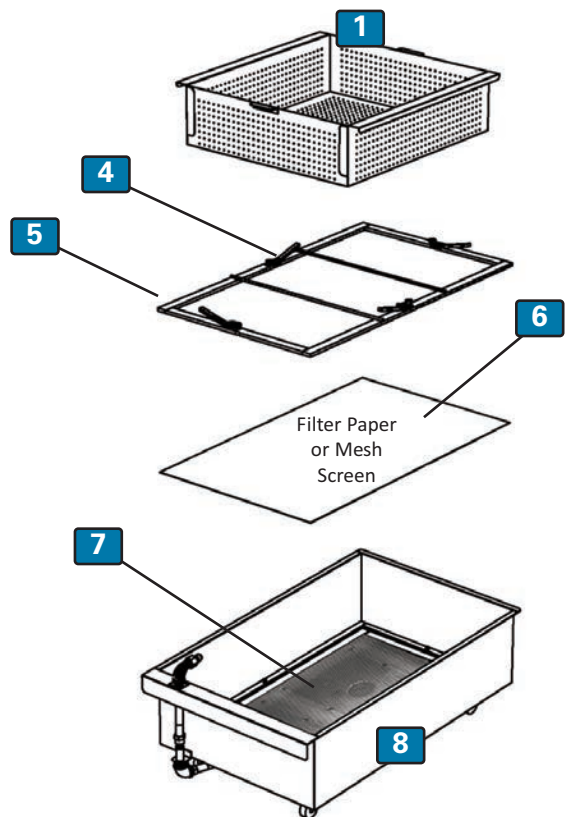
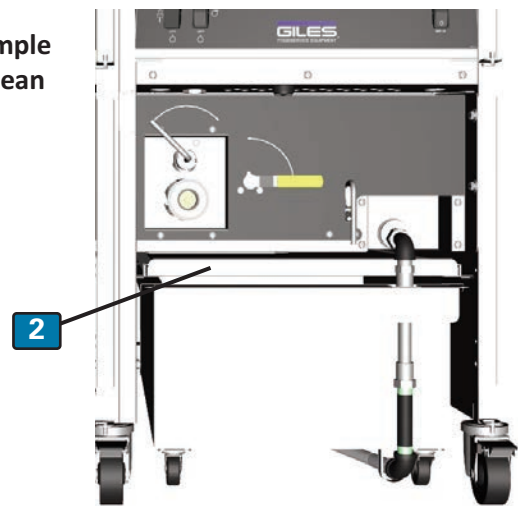

6-02. Cleaning the Filter Pan & Renewing Filter Media - Continued

- 7. Reassemble the **Filter Pan** and install either (1) new sheet of **Filter Paper**, or the clean, dry **SSFS Screen**, as applicable.
- 8. Reinstall **Filter Pan Cover**, position assembled **Filter Pan** under Fryer and re-connect the quick-disconnect hose ⑨.

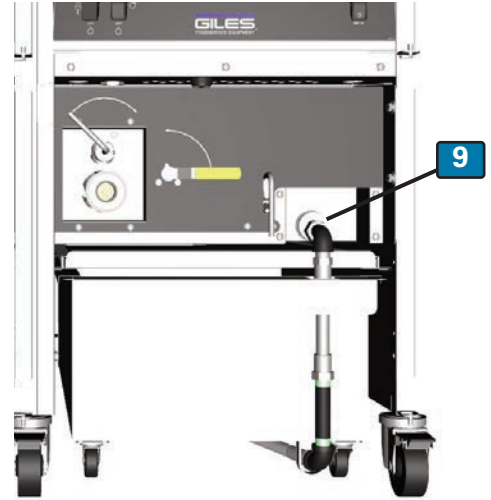

NOTE: Stainless Steel Filter Screen (SSFS)

With proper use and care, this reusable filter screen should have a long service life. It should be replaced if it becomes torn, punctured, frayed or if the silicone sealing gasket around the edge becomes significantly damaged.

Proper use of a suitable filter aid is essential to the performance of this mesh filter.



Notes:

7. Troubleshooting

This section describes troubleshooting procedures. **IMPORTANT! Most troubleshooting and repairs should only be performed by qualified service technicians.** Users should only attempt actions involving operational procedures. For more detailed professional evaluation, wiring diagrams are provided for each unit; they are attached to the Back Panels, if needed.

7-01. Temperature Control System		
Problem	Probable Cause	Corrective Action
FRYER WILL NOT TURN ON: No power light	A. Not connected to power supply	Connect to proper power supply
	B. Supply power circuit breaker tripped	Check circuit breakers in electrical panel
	C. Blown fuse on unit	Check fuses on back of unit (access cover must be removed)
	D. Faulty fuse holder	Replace fuse holder on unit (access cover must be removed)
	E. Faulty power switch	Replace power switch
	F. Incorrect power supply voltage	Connect unit to proper power supply
FRYER WILL NOT HEAT: Power light ON ; Heat light OFF	A. Heat Switch not placed in the HEAT , or ON position	Place Heat Switch in the HEAT , or ON position
FRYER WILL NOT HEAT: Power light ON Heat Switch in HEAT , or ON position Heat Light is OFF	A. Temperature setpoint is below actual oil temperature	Set controller to higher temperature, if setpoint is correct, allow oil to cool
	B. Drain Valve is open; alarm sounding, error msg displayed	Close & lock Drain Valve, press alarm reset on controller
	C. Faulty unit Controller	Replace Controller
	D. Variable temperature sensor is shorted, or open	Replace sensor
	E. Loose or faulty wiring in heat control circuit	Inspect and repair wiring
	F. Faulty Contactor	Replace faulty Contactor
	G. Faulty heating element	Replace faulty element
	H. Faulty Heat Switch	Replace Heat switch
	I. Low oil level	Turn power switch OFF , add oil to proper level
	J. START key not pressed after power-up.	Press START key to enter PREHEAT

7-01. Temperature Control System - Continued		
Problem	Probable Cause	Corrective Action
FRYER HEATING SLOWLY: Slow recovery Heat Light staying ON continuously	A. Incorrect cooking procedures	Consult Operation Manual for proper procedures
	B. Heating element failing	Replace faulty element
	C. Contactor failing	Replace faulty contactor
	D. Loose wiring in heat control circuit	Inspect and repair wiring
	E. Faulty power switch	Replace power switch
	F. Low power supply voltage	Correct power supply
FRYER HEATS SLOWLY: Short Cycling; Heat Light CONTINUOUSLY cycling ON & OFF	A. Low power supply voltage	Correct power supply
	B. Variable temperature sensor too close to heating element	Reposition sensor to proper location
	C. Faulty cooking Controller	Replace Controller
ERRATIC OIL TEMPERATURE:	A. Faulty temperature sensor	Replace Sensor probe
	B. Contactor failing	Replace faulty contactor
	C. Faulty cooking Controller	Replace Controller
	D. Loose wiring in heat control circuit	Inspect and repair wiring
OIL SMOKING:	A. Oil is old, used too long	Boil-out vat, fill with fresh oil
	B. Cooking temperature too high	Check temperature setting, adjust
	C. Heating elements are dirty	Clean vat (boil-out), scrub elements with provided brushes
	D. Faulty heating element	Replace faulty element
	E. Improper voltage for elements installed in unit	Supply proper voltage power to unit
	F. Oil level is LOW	Keep oil at FULL level (without product)

7-01. Temperature Control System - Continued

Problem	Probable Cause	Corrective Action
FRYER WILL NOT HEAT: Power Light ON Heat Switch in HEAT (ON) position High-Limit Light ON	A. Power surge	Place Power Switch to OFF for 5 seconds, return to ON
	B. Contactor is sticking	Replace faulty Contactor
	C. High-Limit board has failed	Replace faulty control board
	D. High-Limit sensor shorted, or open	Replace sensor probe
	E. Incoming power line noise	Install line filter, or remove source of line noise

7-02. Oil Filtration System

Problem	Probable Cause	Corrective Action
OIL WILL NOT PUMP THROUGH FILTER SYSTEM, BACK TO FRYER VAT:	A. Pump Switch has not been place in the ON position	Place Pump Switch (on the FFLT Panel) in the ON position
	B. Air leak in system piping	Check all connections, hoses, filter pan, etc.
	C. Pump motor has failed	Replace faulty motor
	D. Oil Pump is clogged or seized (used for boil)	Clean out, free pump and re-oil
	E. Diverter Valve handle not in the TO FRYER position	Place valve handle (inside FFLT cabinet) in proper position
	F. Pump Oil Return Valve handle is in the CLOSED position	Position handle to the VAT FILL position
	G. Oil allowed to sit in pump too long and has congealed	Run clean, warm oil through pump
	H. Oil has become to cold to pump, below 200°F (93°C)	Manually remove cold oil from the Filter Pan
	I. Filter Pan is not assembled correctly	Assemble Pan correctly (see Manual)
	J. Filter Pan excessively dirty, too much residue accumulation	Clean Filter Pan

7-03. Basket Lift System (Only if Equipped)		
Problem	Probable Cause	Corrective Action
BASKET LIFT WILL NOT OPERATE (UP OR DOWN):	A. Power not ON	Place Power Switch in ON position
	B. Basket Lift Switch is not in the ON position	Place Lift Switch in ON position to enable Basket Lifts
	C. Faulty cooking Controller	Replace cooking Controller
	D. Micro-switch on the Lift assembly is not of adjustment	Adjust switch
	E. Faulty Micro-switch on the Lift assembly	Replace switch
	F. Faulty Lift motor	Replace motor
	G. Controller still in PREHEAT state	Allow fryer to enter READY state

8. Parts List

This section lists some of the various parts that are available for replacement on the unit. This is not an all inclusive listing; please contact an authorized Giles representative or service agent concerning other parts that may be replaced in the field.

8-01. Parts Ordering and Service Information

Parts and service are available through factory-approved service agents and kitchen equipment dealers. If assistance or repair is required, contact a Giles Manufacturers Representative to locate a local service agent or dealer. For further assistance, contact Giles at one of the following phone numbers:

IN THE UNITED STATES & CANADA call: 800.554.4537

ALL OTHERS call: 334.272.1457

Normal business hours are 8:00 AM to 5:00 PM Central Time ... calls are handled by an automated system. Technical/Customer Support is always available either during or after normal hours ... please follow the recorded instructions.

Website: www.gfse.com or e-mail services@gfse.com.

The goal at Giles is to provide the best possible customer service and assistance. To help us accomplish this, please obtain the following information and have it readily available when calling. The information is recorded on a Data/Serial Label attached to the Back Panel of each Fryer unit.

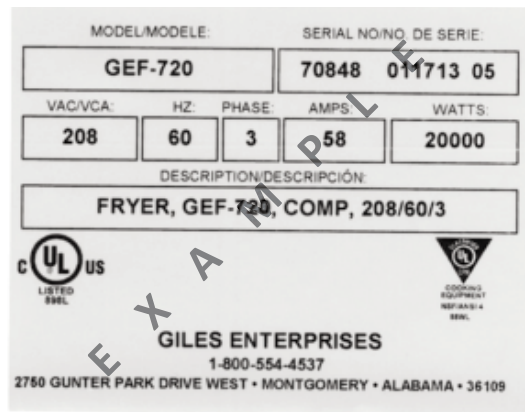

The area below may be helpful in recording information for use as a quick reference.

Model Number: _____

Serial Number: _____

Phase: _____

Voltage: _____

Be prepared to describe the nature of the problem being experienced.

8-02. EOF-20 Front Header & Control Panel (Right-Side)

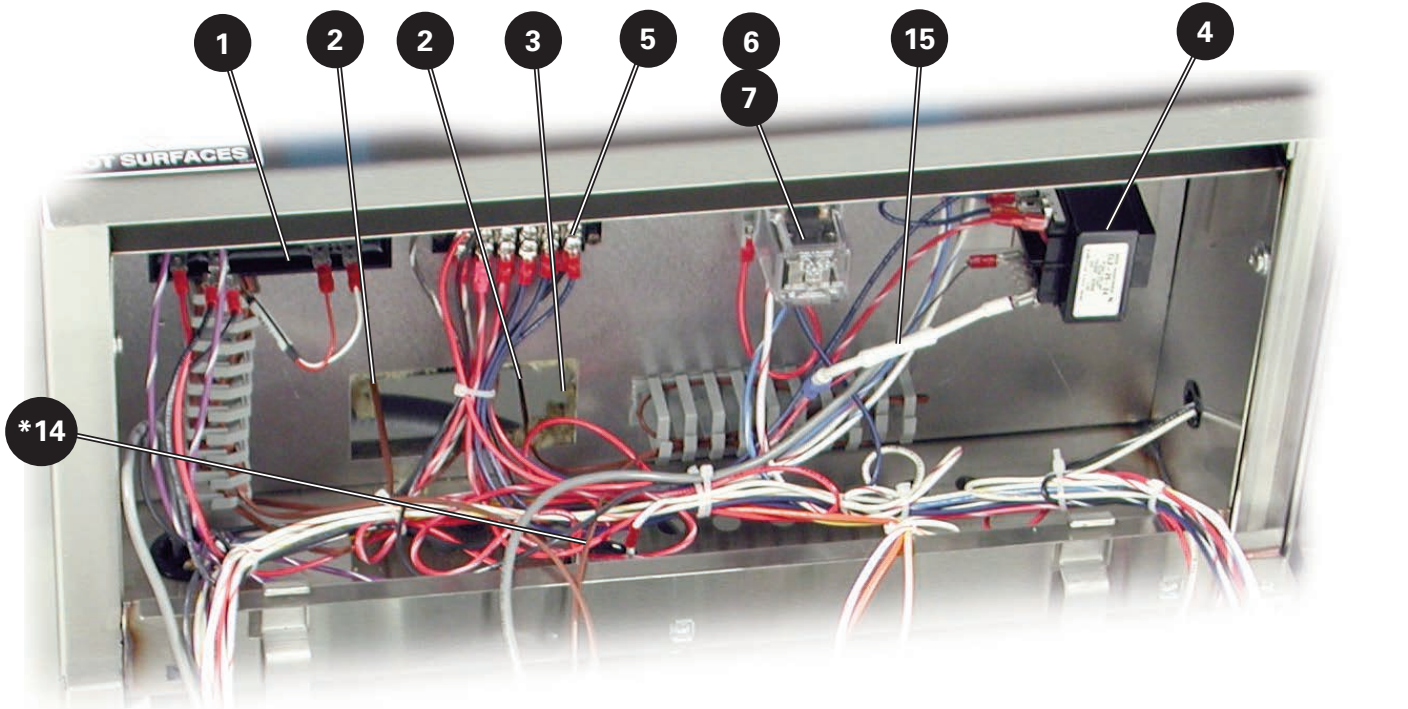

* Hidden



8-02. EOF-20 Control Panel & Front Header (Right-Side)

Item	Part Number	Qty	Description
1	23755	1	THERMOSTAT, SAFETY, 450°F
2	20315	2	THERMOCOUPLE, J-TYPE, 13.5, UNGROUNDED (Requires #45111, FERRULE)
3	23900	1	THERMOCOUPLE, J-TYPE, 3, GROUNDED (Requires #45111, FERRULE)
4	20366	1	TRANSFORMER, 20VA, 115/230V, 60HZ, CL2
5	23751	1	TERMINAL BLOCK, 6-POLE
6	21101	1	SOCKET, RELAY, 8 PIN, 300V, 10A
7	21102	1	RELAY, 8 PIN, 240V, 10A
8	21190	1	SWITCH, ROCKER, D.P.S.T. 250V, 10A
9	21052	2 or 3	SWITCH, ROCKER, D.P.D.T. 250V, 10A
10	21379	1	CONTROLLER, CC10, DUAL TIMER
11	20399	1	INDICATOR LIGHT, AMBER, 250V, 0.5W
12	20402	1	INDICATOR LIGHT, RED, 250V, 0.5W
13	20398	1	INDICATOR LIGHT, GREEN, 250V, 0.5W
14*	23782	1	SONALERT, CONTINUOUS TONE, 250V
15	38365	1	FUSE ASSEMBLY, 1A, CONTROLLER POWER TRANSFORMER
16	66234	1	LABEL, CONTROL PANEL, CC10, EOF20

ITEM #9: Only (2) required if unit is not equipped with Auto Basket Lifts. Lift Switch position will be plugged if not used.

* Hidden

8-03. EOF10-10 Front Header & Control Panel (Left-Side)

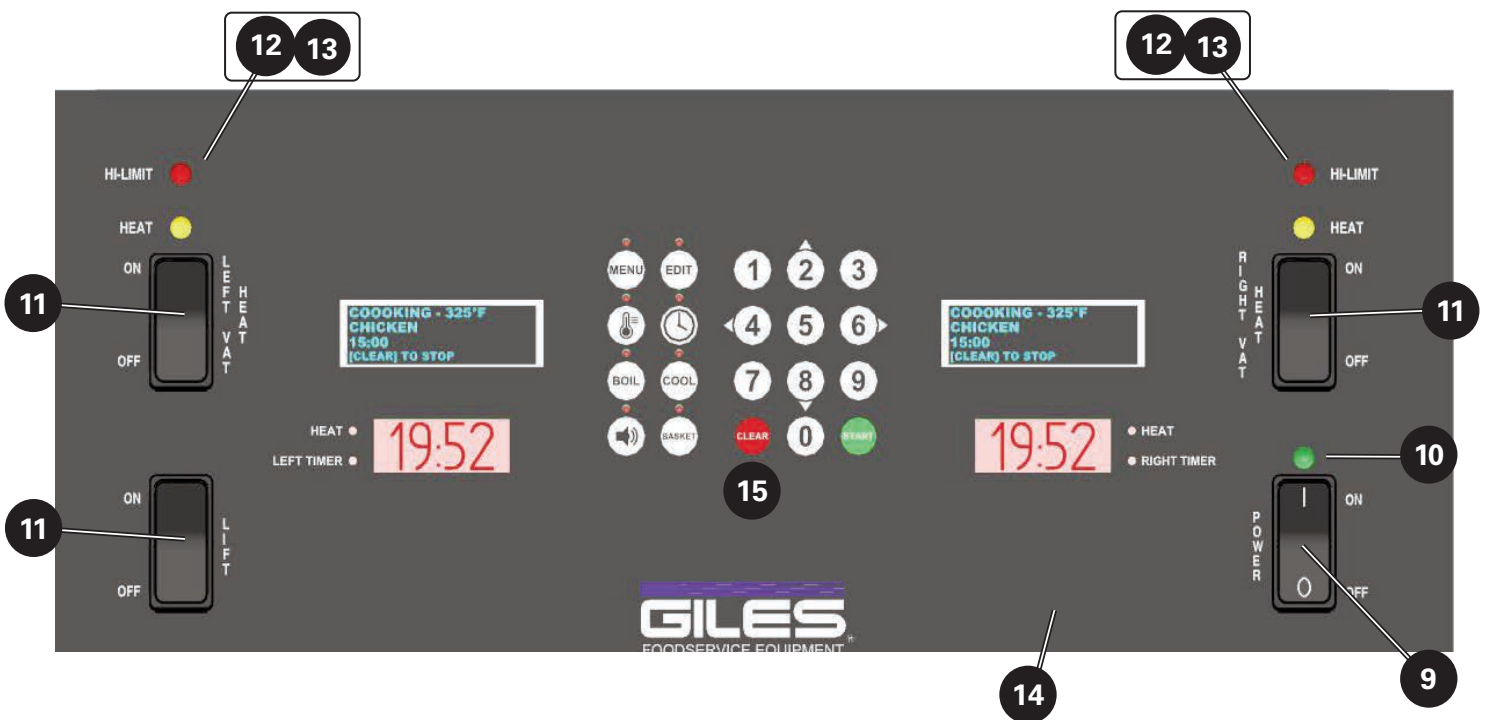
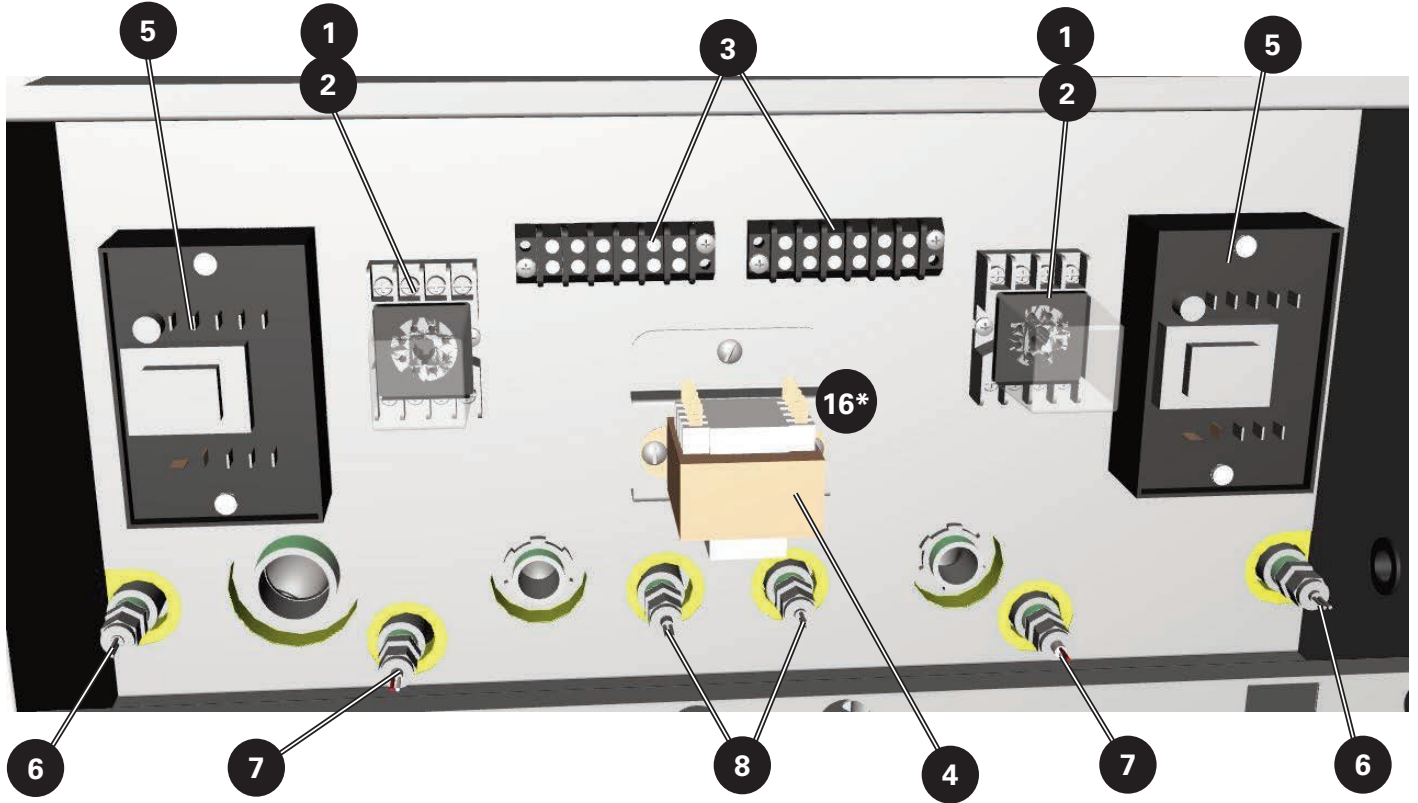

* Not shown

8-03. EOF10-10 Front Header & Control Panel (Left-Side)

Item	Part Number	Qty	Description
1	21101	2	SOCKET, RELAY, 8 PIN, 300V, 10A
2	21102	2	RELAY, 8 PIN, 240V, 10A
3	23751	2	TERMINAL BLOCK, 6-POLE
4	20366	1	TRANSFORMER, 20VA, 115/230V, 60HZ, CL2
5	23755	2	THERMOSTAT, SAFETY, 450°F
6	20315	2	THERMOCOUPLE, J-TYPE, 13.5, UNGROUNDED (Requires #45111, FERRULE)
7	20362	2	THERMOCOUPLE, J-TYPE, 7.5, UNGROUNDED (Requires #45111, FERRULE)
8	20365	2	THERMOCOUPLE, J-TYPE, 12", GROUNDED (Requires #45111, FERRULE)
9	21190	1	SWITCH, ROCKER, D.P.S.T. 250V, 10A
10	20398	1	INDICATOR LIGHT, GREEN, 250V, 0.5W
11	21052	2 or 3	SWITCH, ROCKER, D.P.D.T. 250V, 10A
12	20399	2	INDICATOR LIGHT, AMBER, 250V, 0.5W
13	20402	2	INDICATOR LIGHT, RED, 250V, 0.5W
14	66129	1	LABEL, CONTROL PANEL, CC10, EOF10-10
15	21380	1	CONTROLLER, CC10, DUAL DISPLAY, EOF10-10
16*	38365	1	FUSE ASSEMBLY, 1A, CONTROLLER POWER TRANSFORMER

* Not shown

8-04. EOF10-10 Front Lower Cabinet (Left-Side)

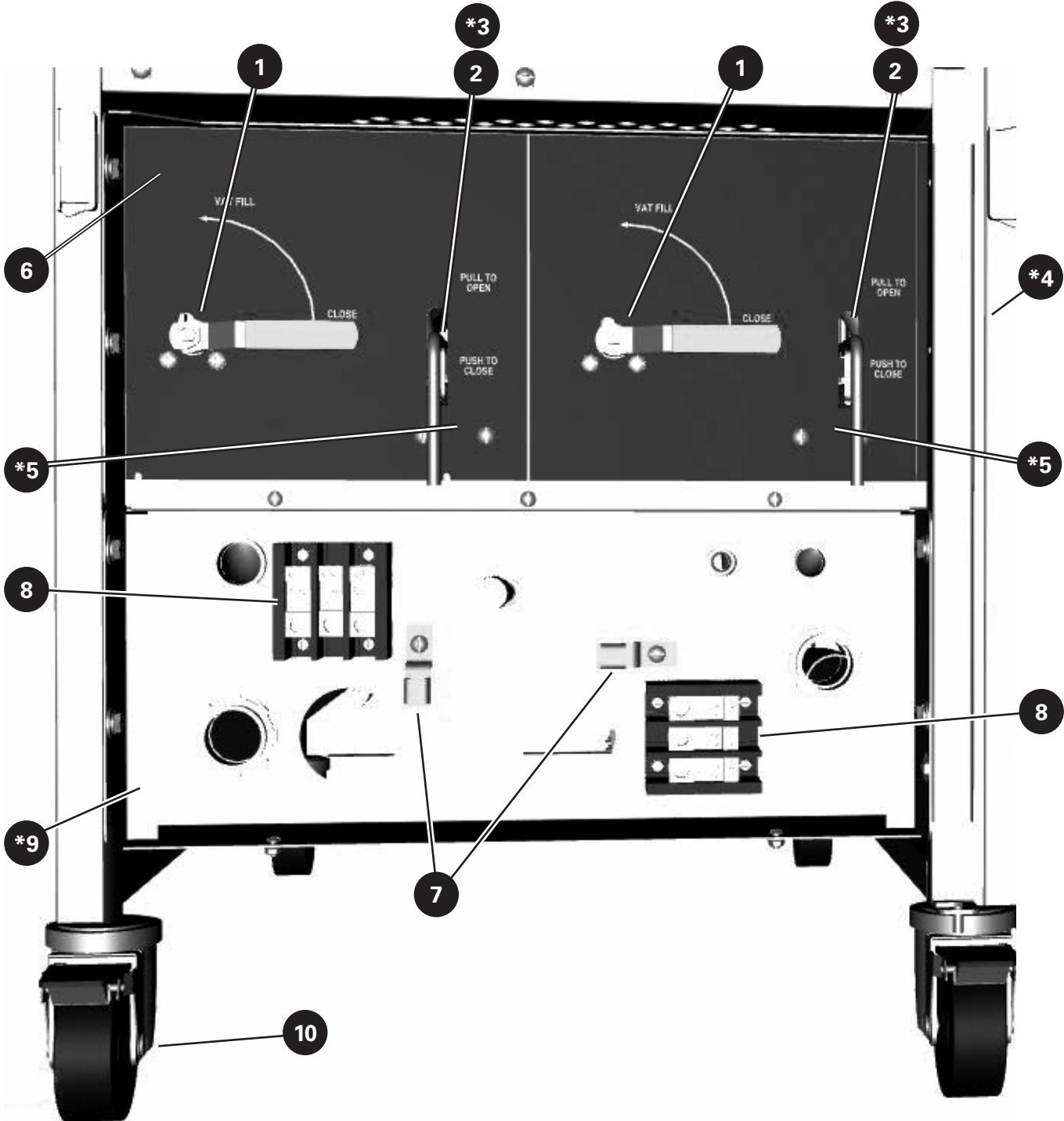

* Not shown/Hidden



8-04. EOF10-10 Front Lower Cabinet (Left-Side)

Item	Part Number	Qty	Description
1	40784	2	VALVE, BALL, 1/2-IN, S/S W/NONSTICK SEALS
2	39257	2	DRAIN PULL HANDLE, WELD ASSEMBLY
*3	40818	2	VALVE, BALL,1-1/4, DRAIN, SGL.THREAD END
*4	35151	1	DOOR ASSEMBLY (WITHOUT PLASTIC HANDLE)
*5	21157	2	LIMIT SWITCH, DRAIN, 15A, 250V (BEHIND PANEL)
6	63986	1	LABEL, FRONT BRACE, EOF10-10 UNIT
7	21051	2	GROUND LUG, 1/0-2/0, 125A, 1/4" HOLE
8	21164	2	POWER DISTRIBUTION BLOCK
*9	92300	1	COVER, SERVICE ENTRANCE
10	40704	3	CASTER, 4-1/2", SWIVEL, STEM MT w/BRAKE

* Not shown/Hidden

8-05. EOF-20 Front Lower Cabinet (Right-Side)

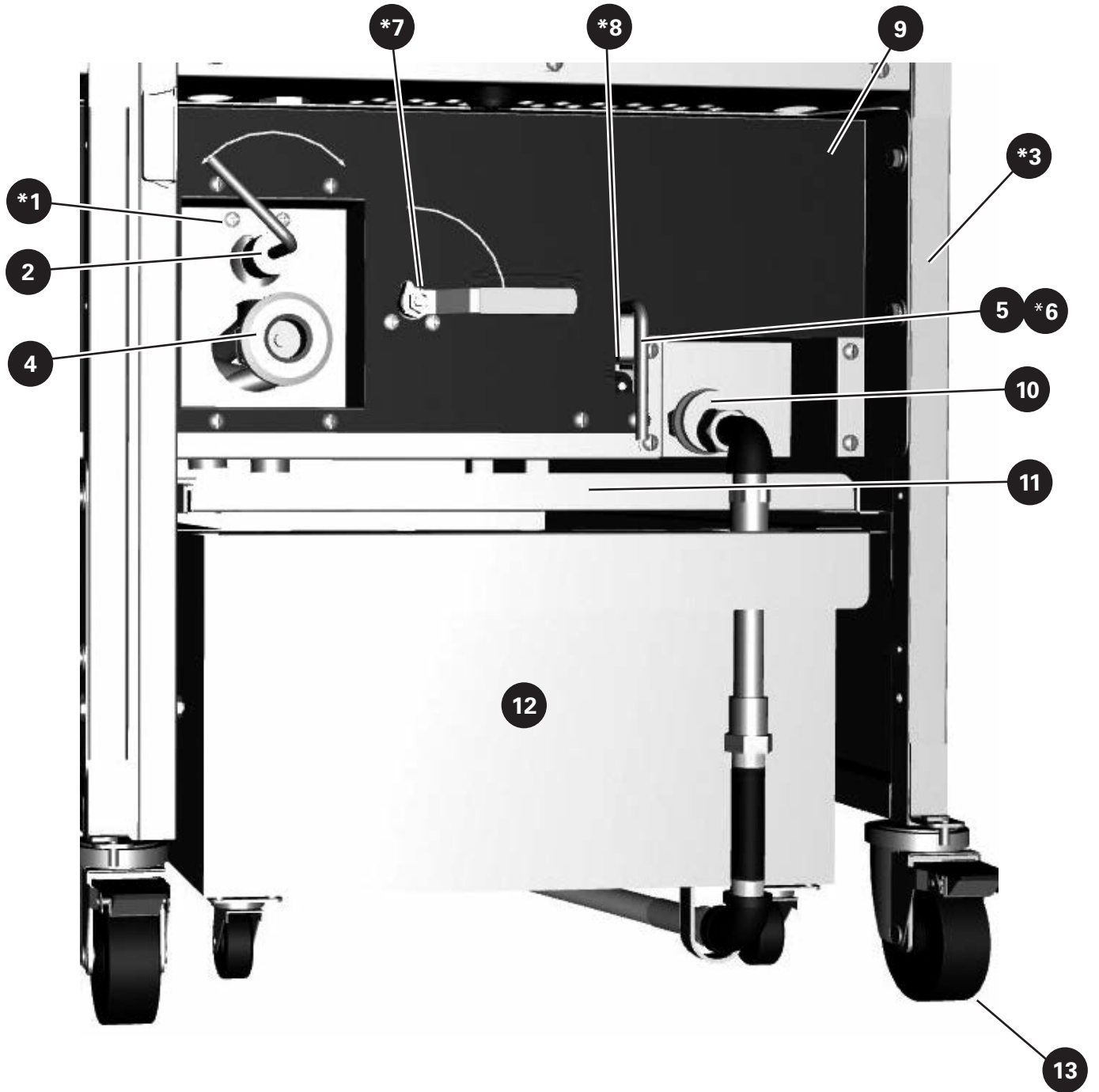

* Hidden/Not Shown



8-05. EOF-20 Front Lower Cabinet (Right-Side)

Item	Part Number	Qty	Description
1	45755	1	VALVE, 3-WAY, 1/2NPT, NICKEL PLATED
2	39382	1	HANDLE, DIVERter VALVE, LEFT
*3	35151	1	DOOR ASSEMBLY (WITHOUT PLASTIC HANDLE)
4	41699	1	COUPLING, DISCHARGE, QUICK-CONNECT, FEMALE
5	39257	1	DRAIN PULL HANDLE, WELD ASSEMBLY
*6	40818	1	VALVE, BALL,1-1/4, DRAIN, SGL.THREAD END
*7	40784	1	VALVE, BALL, 1/2-IN, S/S
*8	21157	1	LIMIT SWITCH, DRAIN, 15A, 250V (BEHIND PANEL)
9	65565	1	LABEL, FRONT BRACE, EOF-10-10/20 RIGHT SIDE
10	41900	1	COUPLING, FILTER PAN, QUICK-CONNECT, FEMALE
11	92285	1	COVER, FILTER PAN, EOF10-10/20
12	35813	1	FILTER PAN, COMPLETE ASSEMBLY, EOF10-10/20
13	40704	3	CASTER, 4-1/2", SWIVEL, STEM MT w/BRAKE

* Hidden/Not Shown

8-06. Cook Vats

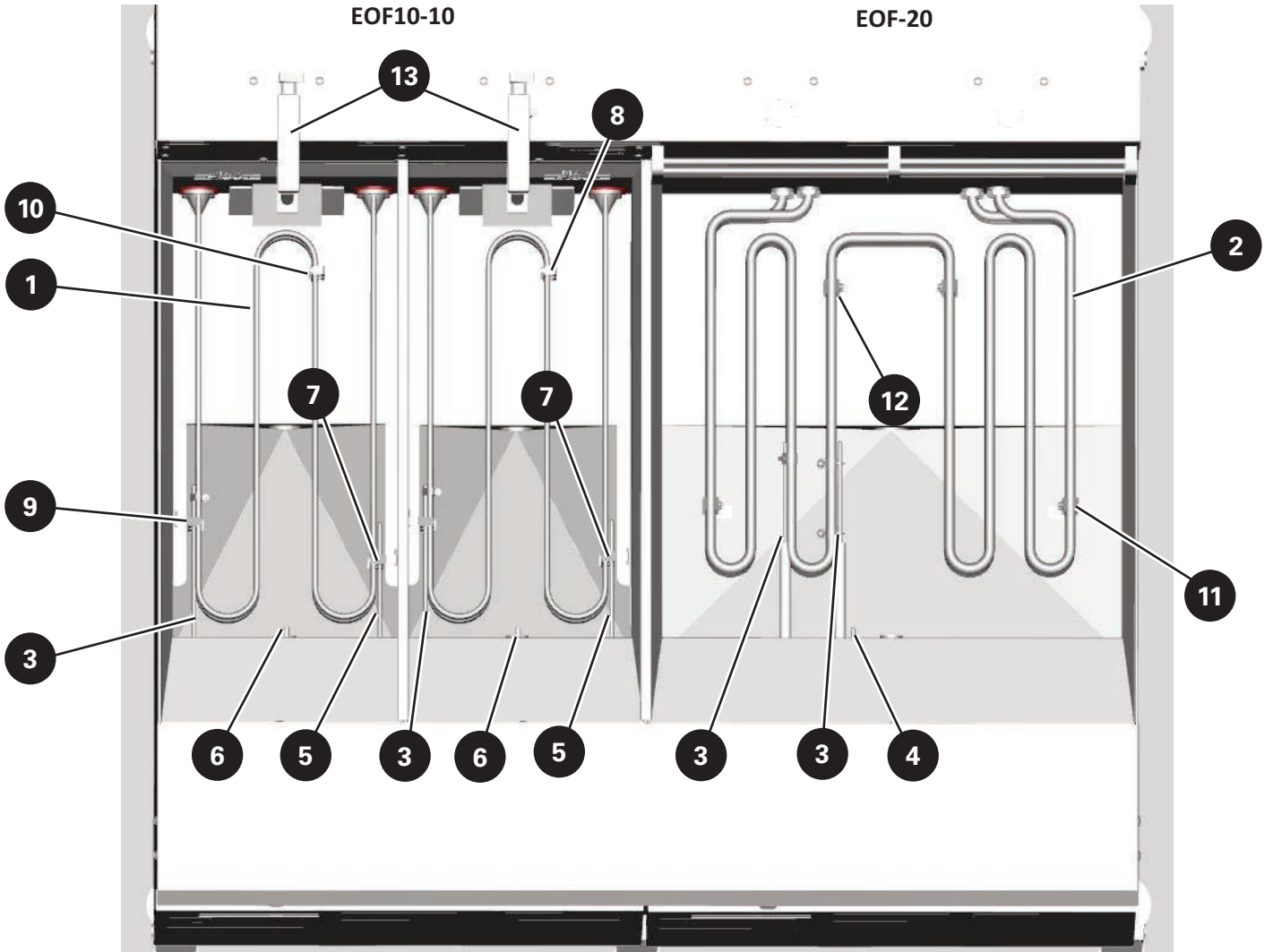

8-06. Cook Vats

Item	Part Number	Qty	Description
1	20357	4	ELEMENT, 6000W, 208V, FIREBAR, EOF10-10
	20359	4	ELEMENT, 6000W, 480V, FIREBAR, EOF-10-10
2	20003	4	ELEMENT, ROUND, 6000W, 208V, EOF-20
	24257	4	ELEMENT, ROUND, 6000W, 480V, EOF-20
3	20315	4	THERMOCOUPLE, J-TYPE, 13-1/2", UNGROUNDED (ELEM. TEMP SENSOR)
4	23900	1	THERMOCOUPLE, J-TYPE, 3", GROUNDED (EOF20 OIL TEMP SENSOR)
5	20365	2	THERMOCOUPLE, J-TYPE, 12", GROUNDED (EOF10-10 HI-LIMIT SENSOR)
6	20362	2	THERMOCOUPLE, J-TYPE, 7-1/2", UNGROUNDED (EOF10-10 OIL TEMP SENSOR)
7	39972	2	ELEMENT BRACKET, HI-LIMIT, EOF-10-10
8	39974	5	ELEMENT SPACER BRACKET, EOF-10-10
9	39975	4	BRACKET, ELEM. SUPPORT, EOF-10-10
10	39973	2	BRACKET, ELEM. STANDOFF, EOF-10-10
11	35085	2	BRACKET, ELEM. STANDOFF, EOF-20
12	35086	6	BRACKET, ELEMENT SPACER, EOF-20
13	39403	2	BASKET CARRIER ASSEMBLY

8-07. Rear Cabinet

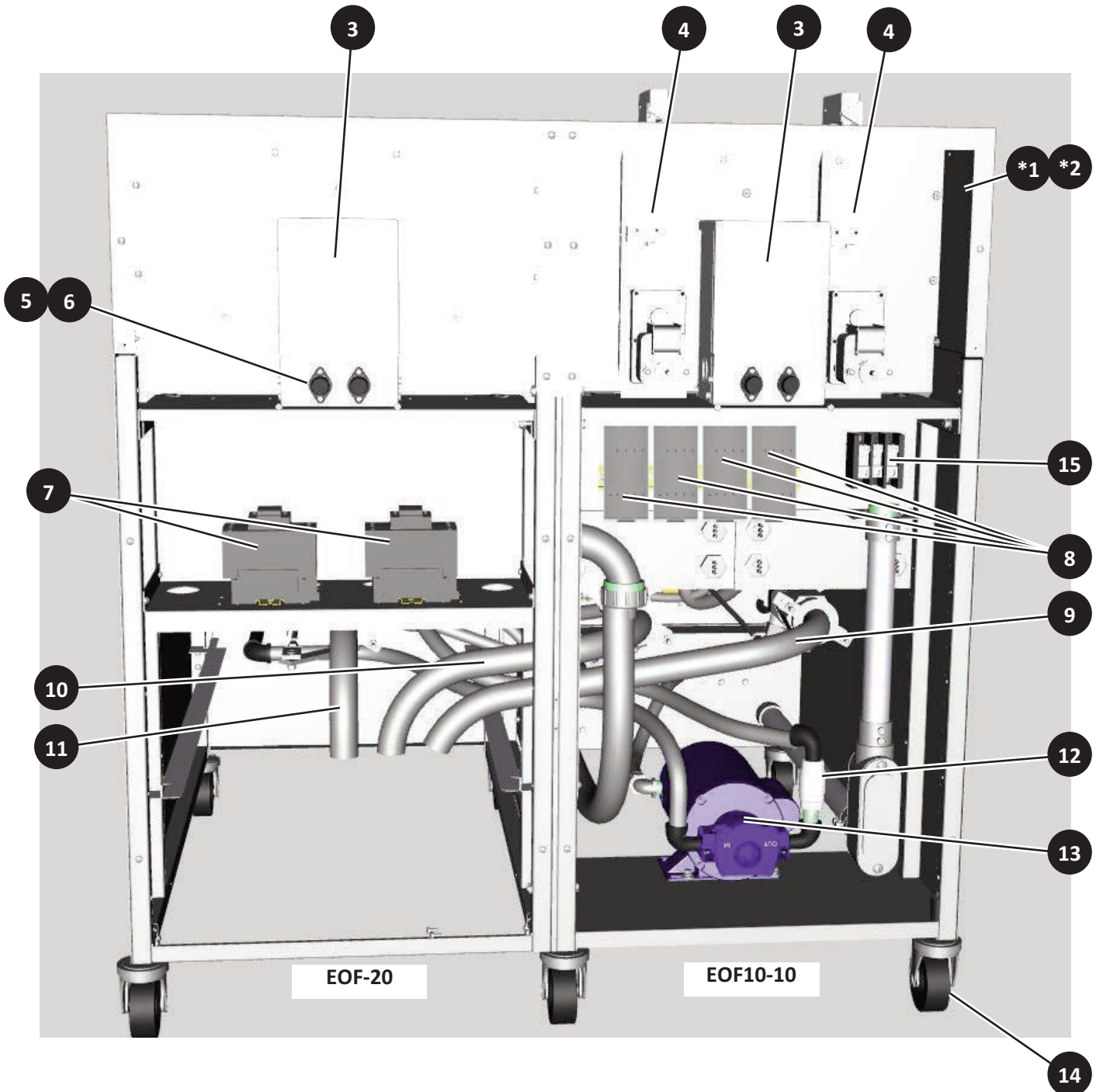

* Hidden/Not Shown

8-07. Rear Cabinet

Item	Part Number	Qty	Description
*1	34971	2	REAR PANEL
*2	90284	2	FUSE COVER, REAR PANEL
3	38473	2	TRANSFORMER ASSEMBLY, COMPLETE w/FUSES, (480V UNIT ONLY)
	92341	2	BREAKER ASSEMBLY, COMPLETE w/FUSES (208-240V UNIT ONLY)
4	35166	2	ELEVATOR ASSEMBLY, COMPLETE
5	21950	4	HOLDER, FUSE, 300V, 15A, SC 0 TO 15 (INCLUDED w/ITEM #3)
6	21900	4	FUSE, 15-AMP, SC-15 (INCLUDED w/ITEM #3)
7	20624	2	CONTACTOR, 60A RES, 4-POLE, MULTI-VOLT COIL (EOF-20)
8	21245	4	CONTACTOR, 60A RES, 3-POLE, MULTI-VOLT COIL (EOF10-10)
9	40989	1	DRAIN TUBE, EOF10-10/20, LEFT 10-10 VAT
10	40990	1	DRAIN TUBE, EOF10-10/20, RIGHT 10-10 VAT
11	40991	1	DRAIN TUBE, EOF-20
12	46712	1	CHECK VALVE, 1/2 NPT
13	71754	1	PUMP & MOTOR ASSY, 5-GPM, 1/2HP
	71824	1	MOTOR, 1/2-HP, W/O PUMP HEAD
	76923	1	PUMP, HEAD ONLY, 5-GPM
14	40641	3	CASTER, 4-1/2", SWIVEL, STEM MT
15	21164	1	TERMINAL BLOCK, POWER

* Hidden/Not Shown

8-08. Filter Pan

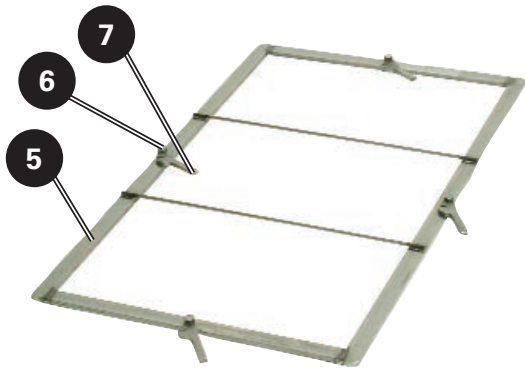

NOTE: PERMANENT SUPPORT
SCREEN ... NOT REMOVABLE

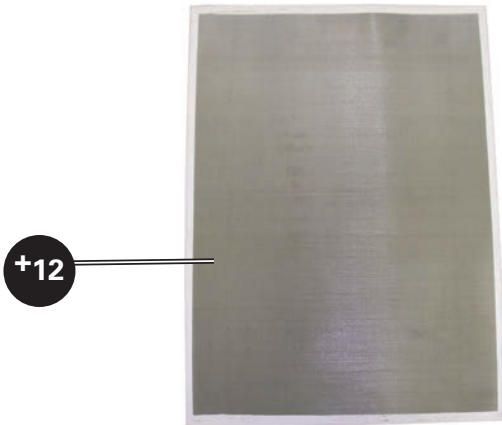
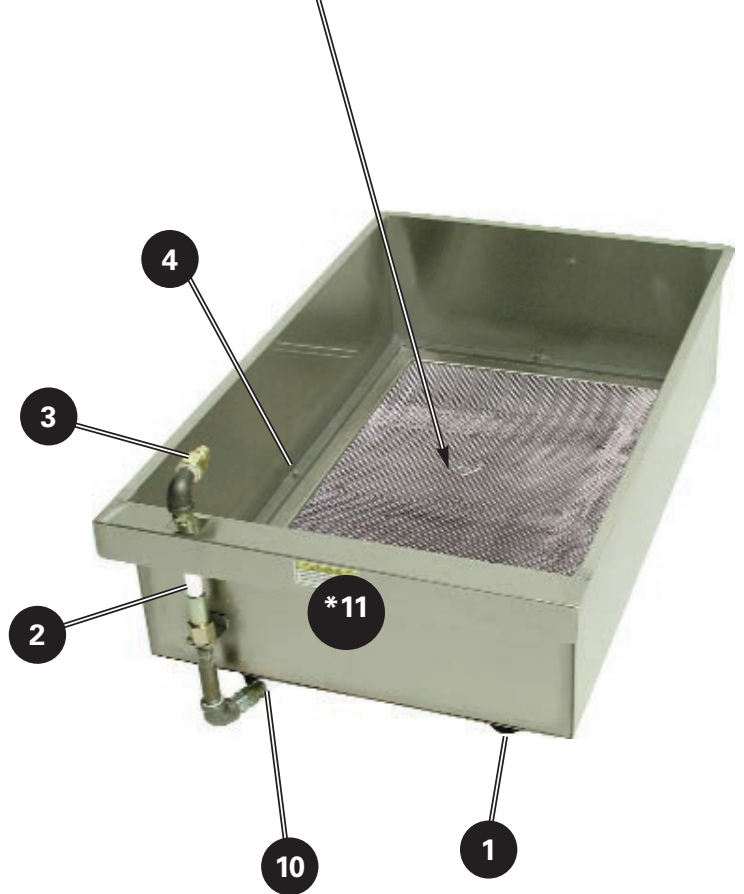
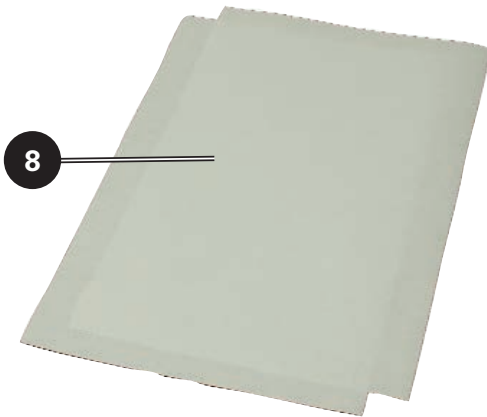

* Complete assembly
+ Optional Item



8-08. Filter Pan

Item	Part No.	Qty.	Description
1	40649	4	CASTER, LOW PROFILE, PLATE MOUNT
2	40956	1	HOSE, 1/2 NPT X 11-1/2", SCT, W/SWIVEL FITTING
3	44150	1	FITTING, BRASS, MALE, 1/2NPT, QUICK-DISCONNECT
4	30039-8	4	STUD, FILTER PAN SUPPORT FRAME
5	35809	1	HOLD-DOWN FRAME, WELD ASSEMBLY
6	30040-4	4	STUD, FILTER PAN HOLD-DOWN FRAME
7	54526	4	LEVER, FILTER PAN HOLD-DOWN FRAME
8	60328	1	PAPER FILTER MEDIA, 19-3/8 X 32-3/8 (100 CT. CASE)
9	36213	1	CRUMB SCREEN, EOF-20
10	40958	1	HOSE, 1/2NPT X 18", SCT, 1-END SWIVEL
*11	35813	1	FILTER PAN COMPLETE ASSEMBLY (#36213 Crumb Catcher not included)
+12	41019	1	REUSABLE, RENEWABLE FILTER SCREEN, 15-3/8 X 32-3/8 (Optional Item)

* Complete assembly

+ Optional Item

Note: The permanent perforated screen eliminated the need for P/N 40181, Filter Pan Screen, however, 40181 is still required for Filter Pans and/or units manufactured before Dec. 2009.



Notes:

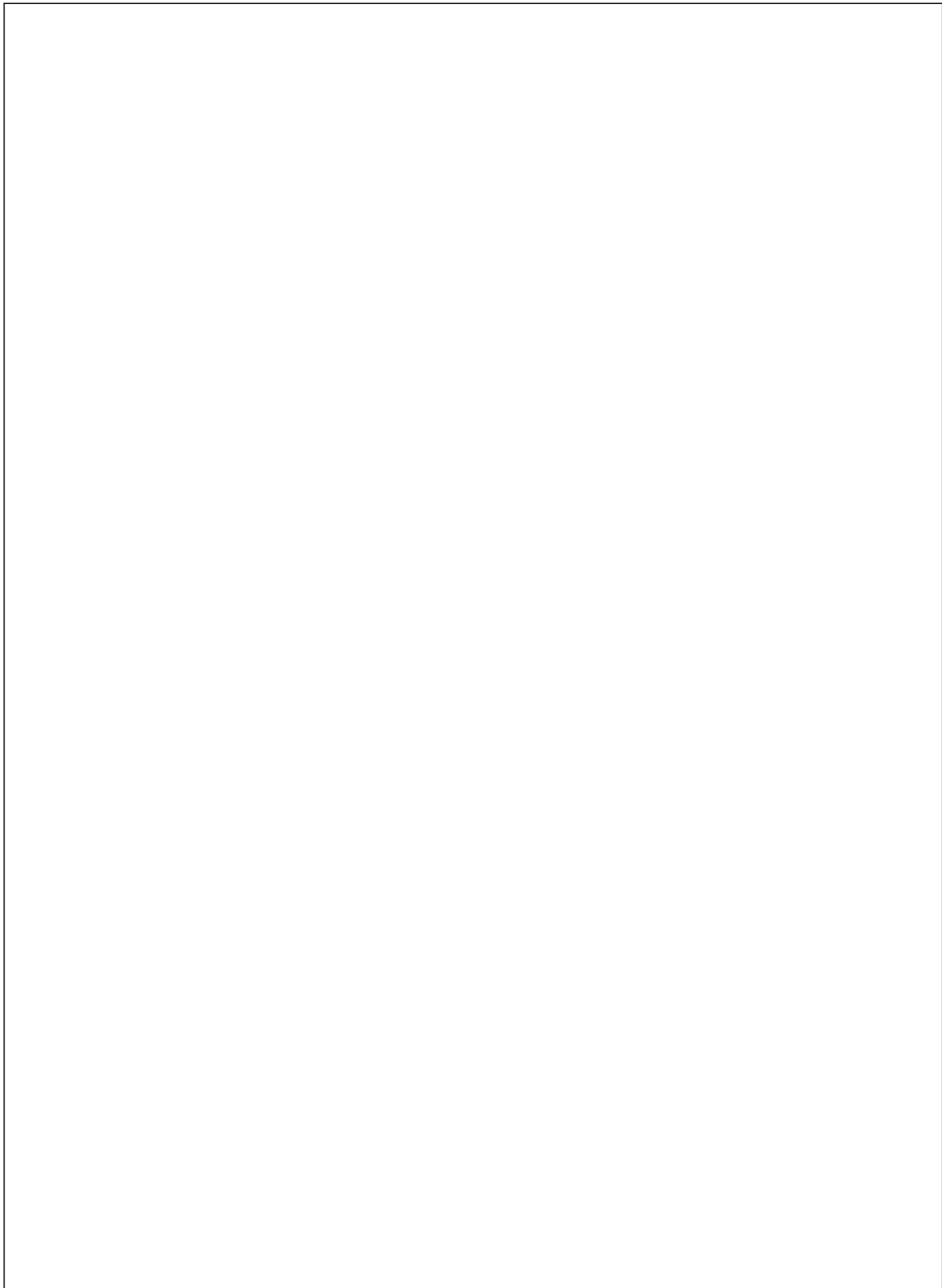



Responsive. Reliable.

2750 Gunter Park Drive West • Montgomery, AL 36109 USA
334.272.1457 • Toll-free 800.554.4537 (USA & Canada Only) • FAX 334.239.4117 • www.gfse.com • e-mail: services@gfse.com

Form No. 60327 (Rel. Date: Nov.1999, Rev. Date: Feb.2018, Rev. D)