

SERVICE MANUAL



 GARLAND®
Mealstream

SERVICE MANUAL

ALL CTM3 MODELS & TIM HORTON'S COMBINATION OVENS
MANUFACTURED FROM JANUARY 2003



CAUTION MICROWAVE EMISSIONS
**DO NOT BECOME EXPOSED TO EMISSIONS FROM THE MICROWAVE GENERATOR
OR PARTS CONDUCTING MICROWAVE ENERGY**

TABLE OF CONTENTS

Microwave safety precautions.....	3
Safety code	4
Product specifications	5
Installation instructions.....	6
Main features	7-8
Principal components: LHS.....	9
Principal components: RHS	10
Principal components: Top.....	11
Principal components: Back view.....	12
Principal components: Door & cavity roof	13
Principal components: External Parts & accessories.....	14
Principal components: Cavity Parts	15
Principal components: Electronic control panel assembly	15
Principal components: Tim Hortons Control panels	16
Principal components: (not shown in main views)	17
Principal components: Input wiring details	18
Principal components: Part no. identification charts	19-21
Procedure for Microwave leakage test.....	22-23
Procedure for Power output measurement	24
Procedures for Principal Component tests	25-26
Procedure for Door interlock adjustment and test	27-29
Procedure for building and fitting the door	30-34
Procedure for replacing door seal assembly.....	35-36
Procedure for removing shelf runners & element cover.....	37
Procedure for replacing Heater Element.....	38
Procedure for replacing Hot air Motor assembly.....	39
Procedure for replacing Magnetron assembly	40-41
Procedure for Testing Membrane panel circuit	42-43
Circuit diagrams	44
Error codes and diagnostics.....	45
Appendix 1: Test Procedure for Tim Hortons.....	46
Appendix 2: MenuKey® Download procedure	47
Appendix 3: Temperature Sensor resistance data	48
Appendix 4: Cleaning Procedure	49
Appendix 5: Hot Air Motor Upgrade	50
Appendix 6: Recommended Spares List.....	51
Appendix 7: Door stop & Adjustable microswitch bracket.....	52
Appendix 8: Door arm guide	53
Manual corrections and modifications.....	54

MICROWAVE SAFETY PRECAUTIONS

CAUTION **WARNING TO SERVICE TECHNICIANS** **PRECAUTIONS TO BE OBSERVED BEFORE AND DURING** **SERVICING TO AVOID POSSIBLE EXPOSURE TO** **EXCESSIVE MICROWAVE ENERGY**

- (a) Do not operate or allow the oven to be operated with the door open.
- (b) Make the following safety checks on all ovens to be serviced before activating the magnetron or other microwave source, and make repairs as necessary:
 - 1) interlock operation.
 - 2) proper door closing.
 - 3) seal and sealing surfaces (arcing, wear, and other damage).
 - 4) damage to or loosening of hinges and latches.
 - 5) evidence of dropping or abuse.
- (c) Before turning on microwave power for any service test or inspection within the microwave generating compartments, check the magnetron, wave guide or transmission line, and cavity for proper alignment, integrity and connections.
- (d) Any defective or misadjusted components in the interlock, monitor, door seal, and microwave generation and transmission systems shall be repaired, replaced, or adjusted by procedures described in this manual before the oven is released to the owner.
- (e)(i) A microwave leakage check to verify compliance with the Federal Performance Standard should be performed on each oven prior to release to the owner. For U.S.A.
- (e)(ii) A microwave leakage check to verify compliance with the Canadian Regulation, HEALTH AND WELFARE, SOR/79 920 should be performed on each oven prior to release to the owner. For CANADA.

SAFETY CODE

This manual is designed to assist engineers who have been on a recognised product familiarisation and training course run by Garland. It has been prepared to offer technical guidance for the Mealstream range of Combination Microwave Ovens.

Please remember that it is wiser **not** to attempt a service task if you are unsure of being able to complete it competently, quickly, and above all **safely**.

To avoid injury to yourself, and to protect the appliance from possible damage, please follow this Safety Code when servicing these ovens.

Before attempting to repair the oven, check it for microwave leakage.

Check that the oven is not emitting microwaves, even when supposedly not in operation.

Check that the oven is not operating continuously, whether the display indicates cooking or not.

Always discharge the HT capacitors before working on the oven using a suitably insulated 10 M Ω Resistor.

Before removing any covers from the oven, do all of the following.

- Switch off the mains supply and remove the plug from the wall socket.
or
- If the oven is hard wired, ensure that the power is turned off at the isolator switch.

Note:

The On/Off switch on the oven is **not** adequate protection against electric shock, as it does not isolate all of the internal wiring from the mains.

Upon completion of a service on a Mealstream oven, or before reconnecting the appliance to the electrical supply for testing, check all of the following points:

- All internal electrical connections are correct (see wiring diagram Page 44-47).
- All wiring insulation is correct and is not touching a sharp edge.
- All grounding connections are electrically and mechanically secure.
- All door safety interlocks are secure and mechanically sound.
- The door operation is smooth, and the arms run freely in the slots.
- The door activates all three of the door interlock switches **in the correct order** (see pages 27-29).
- The temperature sensor is correctly connected to the Power PCB.

Before finishing a service call, recheck the following points:

- All of the electronics are functioning correctly, and all of the touch pads are working.
- Microwave emissions are below permissible limit - 4 mW/cm².
- The power output of the oven is checked in accordance with page 24.
- Oven has correct 2 inch (50mm) air gap all round and 2 inches (50mm) above. Air flow should not be restricted. (see page 6 installation).

PRODUCT SPECIFICATIONS

Model Number: + Voltage + Frequency + Phases + Controls + Country

Model No.	CTM3	
Voltage	208V	20
	240V	24
Frequency	50Hz	50
	60Hz	60
Phases	Single	1
	Three	3
Control Type	Series 5	S5
Country	UK	UK
	N.America	A
Customer Variant	N.America	TH = Tim Hortons

Power Requirements	208Volts 240Volts	208V ac 60Hz 30Amp 2P & G 240V ac 60Hz 40Amp 2P & G
Power Output	Microwave 100% Convection Combination	1425W 3000W 1425W + 3000W
External Dimensions	Height	30 inches (765mm)
	Width	29.5 inches (770mm)
	Depth	25 inches (635 mm)
Manufacturers recommended clearances	Height	32 inches (815 mm)
	Width	31.5 inches (795 mm)
	Depth	27 inches (685 mm)
Internal Dimensions	Height	10.2 inches (260mm)
	Width	19.3 inches (490mm)
	Depth	14.2 inches (360mm)
	Capacity	1.62 ft ³ (45.86 litres)
Weight	Nett	198 lb.s (90 kg)
	Gross packed	227 lbs (103 kg)
Construction	Cavity Casework	304 Stainless Steel
Settings	Microwave Temperature Timer Programs	100%,75%,50%,25%, Convection only Off, 300°F, 350°F, 400°F, 440°F, 480°F Up to 30 minutes per stage Cook Programs can have 3 cooking stages of up to 30 minutes for each stage

INSTALLATION INSTRUCTIONS

Installation Instructions for Mealstream Combination Ovens

Power Supply Requirements

The Mealstream Series should be connected to a suitable electricity supply, which can cope with the switching-on surge that occurs with certain types of catering equipment, including microwaves. Because of this requirement, we strongly recommend that a separate, suitably rated supply is installed for the oven.

The supply for the oven should be fitted with a **Type "C"** or **Time Delay circuit breaker**, rated at:

- 50 Amp for 208V electrical supply (2PH + GND)
- 50 Amp for 240V electrical supply (2PH + GND) Canada models
- 30 Amp for 208V electrical supply (2PH + GND)
- 30 Amp for 240V electrical supply (2PH + GND) US models

If the oven is hard-wired to the supply, a double-pole isolator switch with a contact gap of at least 1/8 inch (3 mm) should be fitted.

Grounding requirement

This appliance must be connected to a grounded, metallic, permanent wiring system, or an equipment grounding conductor should be run with the circuit conductors and connected to the equipment grounding terminal or lead on the appliance.

Positioning the Oven

In order to maintain adequate ventilation for air intake and exhaust, and to allow access for cleaning filters, you must allow a minimum of 2 inches (50 mm) clearance at the sides and rear of the oven, and at least 2 inches (50 mm) above. Air intake temperature should not exceed 110°F/45°C excessive temperature will lead to reduced operating duty cycle, or premature ageing of internal components. Failure to comply with these conditions will invalidate the warranty.

NEVER Install an oven above fryers, grills, griddles or any other major heat source.

NEVER Stack machines on top of each other. Always use a double stand or a separate shelf.

ALWAYS Place containers in the cavity carefully - impact damage may chip the vitreous enamel coating on the runners and baffle plate.

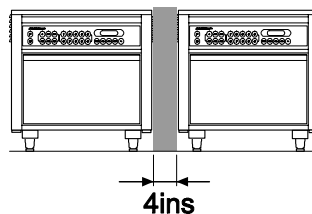
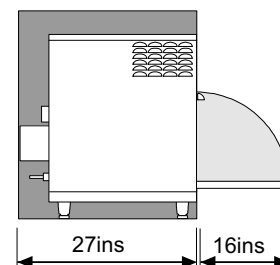
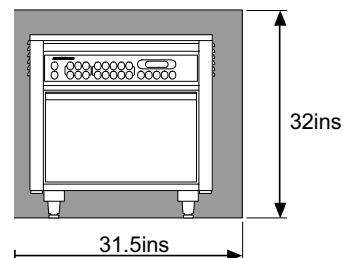

Note:
The minimum recommended clearance required for air flow

MAIN FEATURES

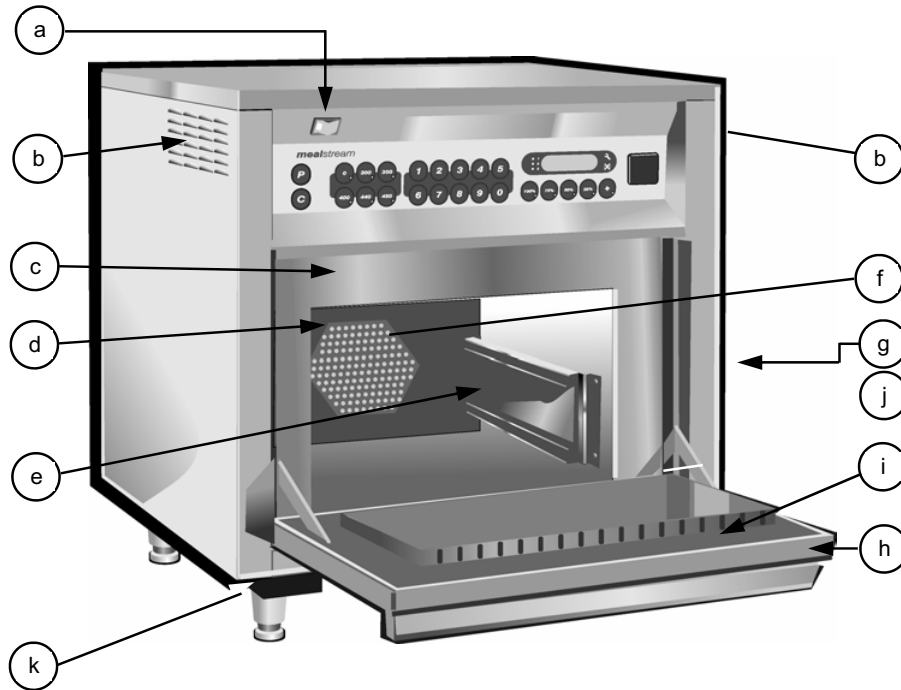

a On/Off SWITCH

This is used to turn the oven On or Off.
IT DOES NOT ISOLATE INTERNAL WIRING FROM THE MAINS SUPPLY.

b EXHAUST VENTS

Allows exhausted air from the magnetron cooling system to escape.

c OVEN CAVITY

The oven cavity is mainly constructed from stainless steel panels. It must be kept clean.

d BAFFLE PLATE

Forms the inside rear of the oven and covers the hot air circulation fan. This must be cleaned on a regular basis, and kept free of debris.

e RUNNERS

These are mounted on each side of the oven cavity to support the rectangular racks or oven trays.

f HOT AIR FAN

Situated behind the baffle plate, and circulates the hot air through the baffle plate, over the heating element, and around the edge of the baffle plate back into the cavity.

g RATING PLATE

The rating plate is situated on the rear of the oven, and states the Model, Serial Number, Electrical Ratings and Manufacturers telephone number.

h DOOR

The door consists of a thermally insulated inner section, and an additional air gap provided by a twin skinned door front to lower the surface temperature.

i DOOR SEAL

j ELECTRICAL SUPPLY CORD

Electrical supply cord is situated on the rear of the oven,

k AIR FILTER

Main intake for cooling air for internal components. Must be clear of obstructions.

MAIN FEATURES

Electronic control panel

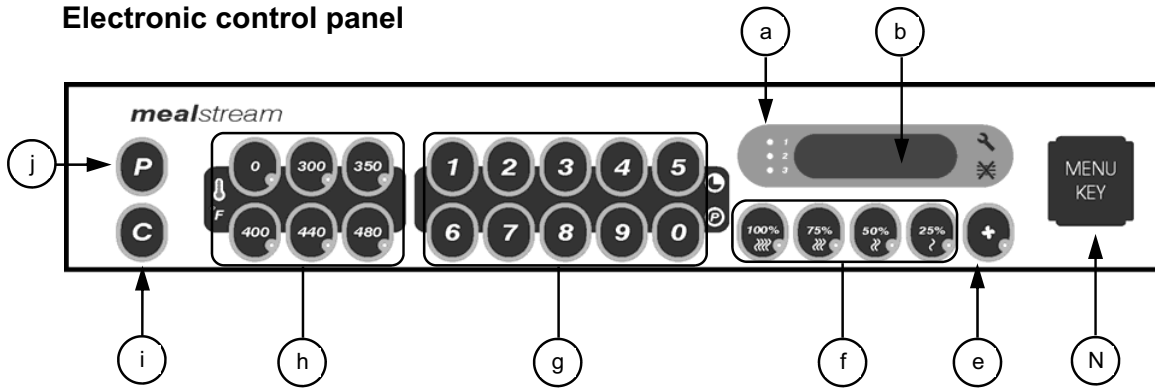

a	Stage LED's
b	Program & Time Display
e	Convection Pad
f	Power Pads
g	Time / Preset Pads
h	Temperature Set Pads
i	Cancel / Callback Pad
j	Program Pad
N	Menukey™

Tim Hortons control panel

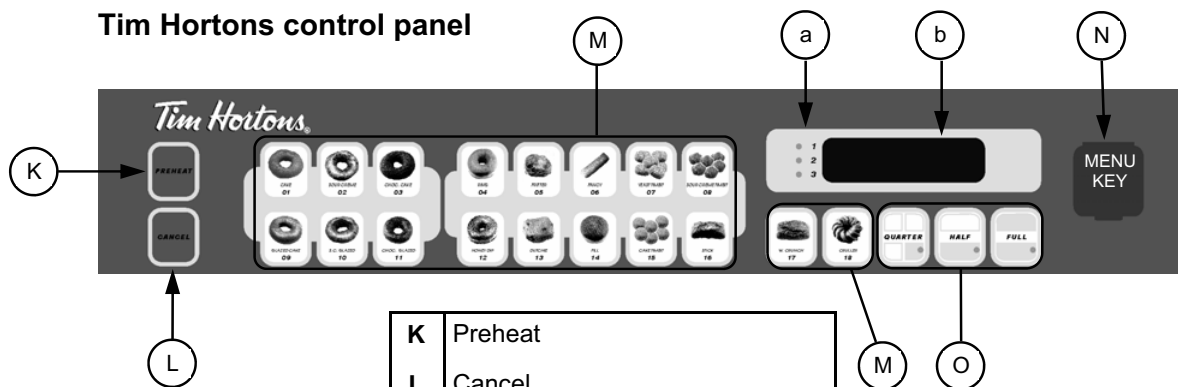

K	Preheat
L	Cancel
M	Icon Cook Pads
N	MenuKey™
O	Quarter, Half & Full Batch Load

PRINCIPAL COMPONENTS

Left side

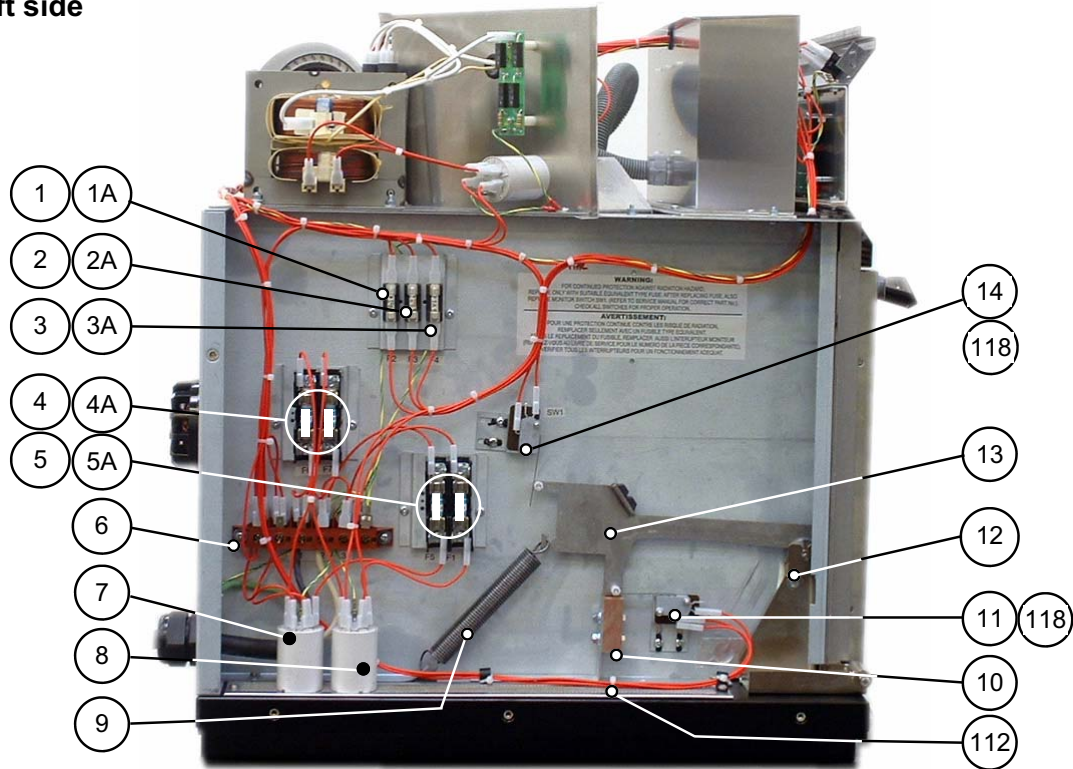

No	Description	208V	240V
1	Fuse holder	30Z0231	30Z0231
1A	Fuse 10 amp	30Z0217	30Z0217
2	Fuse holder	30Z0231	30Z0231
2A	Fuse 10 amp	30Z0217	30Z0217
3	Fuse holder	30Z0285	30Z0285
3A	Fuse 1 amp	30Z0957	30Z0957
4	Fuse holder	30Z1178	30Z1178
4A	Fuse 20 amp	30Z1177	30Z1177
5	Fuse holder	30Z1178	30Z1178
5A	Fuse 20 amp	30Z1177	30Z1177
6	Electrical supply terminal block	31Z0149	31Z0149
7	Filter (Heater circuit)	30Z0997	30Z0997
8	Filter (Microwave circuit)	30Z0997	30Z0997
9	Door spring	40C1141	40C1141
9	Door spring ^A Modification Kit	10C0177	10C0177
10	Door arm stop assembly ^C	11C0279	11C0279
11	Microswitch (Primary)	30Z0240	30Z0240
12	Door hinge assembly (LH) ^B	11C0167	11C0167
13	Door arm assembly	11C0300	11C0300
14	Microswitch (Monitor)	30Z0240	30Z0240
112	Internal Filter LHS	40C0962	40C0962
118	Microswitch support bracket	40C0851	40C0851

Note A:
Ovens before
June 2003

Note B:
See page 17 for
parts

Note C:
For ovens later
than May 2005
See Appendix 7

PRINCIPAL COMPONENTS

Right side

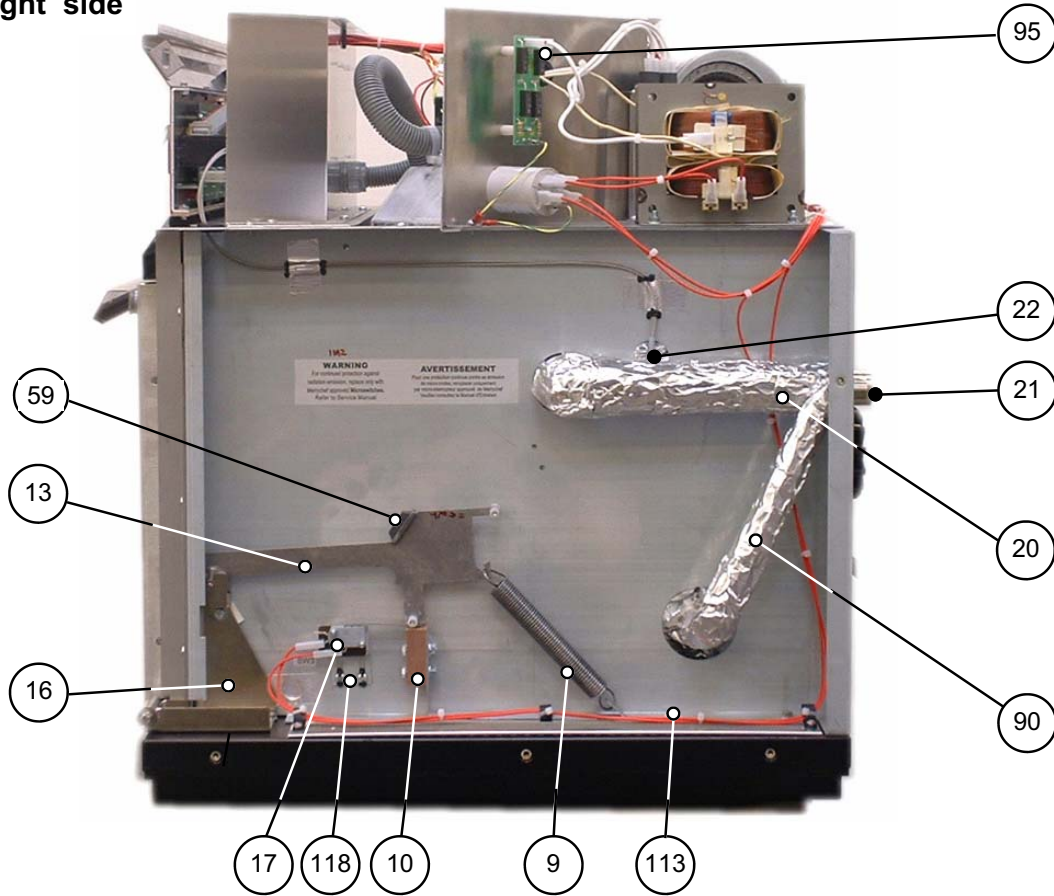

No	Description	208V	240V
9	Door spring	40C1141	40C1141
9	Door spring Kit ^A	10C0177	10C0177
10	Door arm stop assembly ^C	11C0279	11C0279
13	Door arm assembly	11C0300	11C0300
16	Door hinge assembly (RH) ^B	11C0166	11C0166
17	Micro-switch (Secondary)	30Z0240	30Z0240
20	Steam pipe	790046	790046
21	Steam vent guard	790061	790061
22	Temperature sensor	50E123	50E123
59	Rubber stop	31Z1150	31Z1150
90	Cavity Vent Pipe	40C1013	40C1013
95	Diode Board assy. with leads	11M0417	11M0417
113	Internal Filter RHS	40C1080	40C1080
118	Microswitch support bracket ^C	40C0851	40C0851

Note A:
Ovens before
June 2003

Note B:
See page 17 for
parts

Note C: Ovens after May 2005 see Appendix 7

PRINCIPAL COMPONENTS

Top view

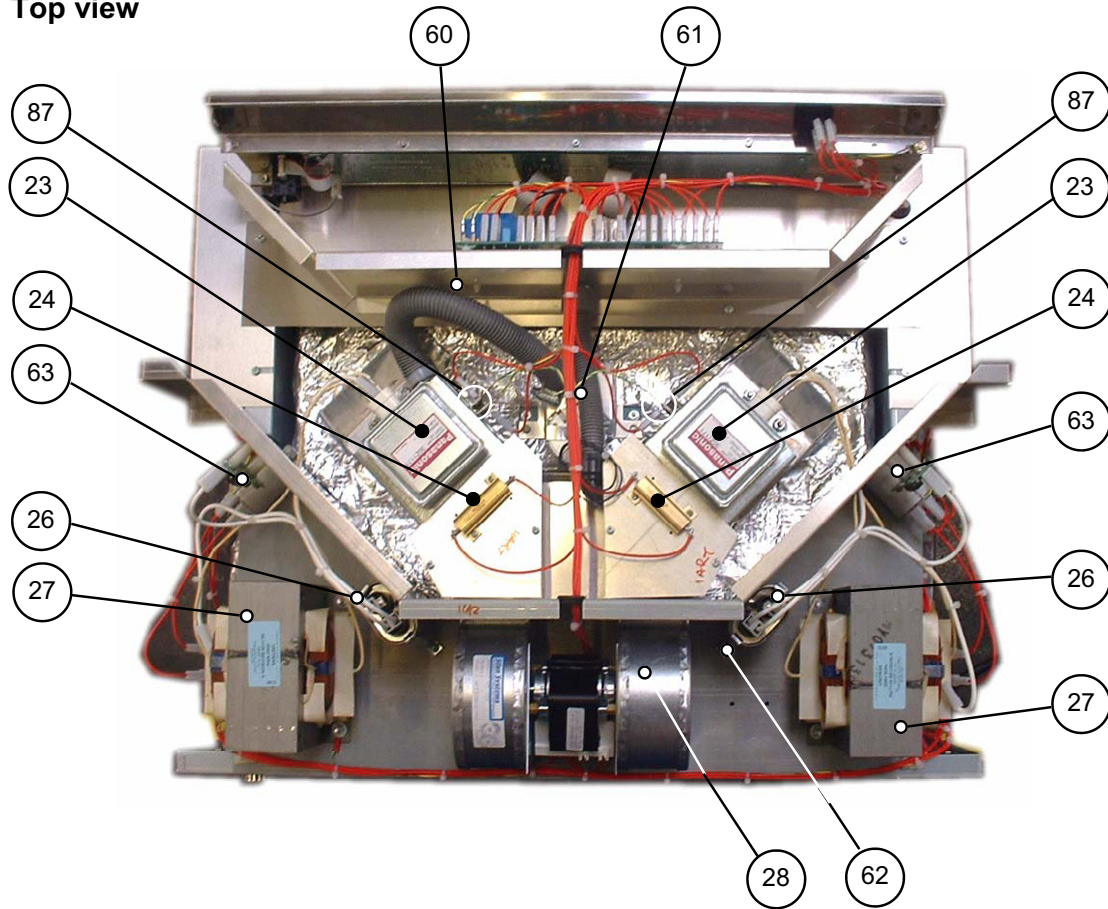

No	Description	208V	240V
23	Magnetron (Panasonic)	30Z1171	30Z1171
24	Resistor 470 R	30Z0283	30Z0283
26	Capacitor 0.88 μ f (2300V) ^D	30Z0861	30Z0861
26	Capacitor 0.88 μ f (2500V) Kit	10C0172	10C0172
27	Transformer ^E	30Z1230	30Z1230
28	Twin blower motor	30Z1145	30Z1145
60	25mm OD Flexible conduit	314402	314402
61	20mm OD Flexible conduit	314401	314401
62	Capacitor clip (88mm)	30Z0521	30Z0521
63	Filter	30Z0997	N/A
87	Magnetron Thermal Trip	2571016	2571016

Note D: This Capacitor is replaced with [30Z1251](#) 0.88 μ f 2500V and 2 x 88mm clips [30Z0521](#) included in a service kit Part No. [10C0172](#)

Note E: All transformers are now replaced by the Multi-tap type Part No. [30Z1230](#)

PRINCIPAL COMPONENTS

Back view

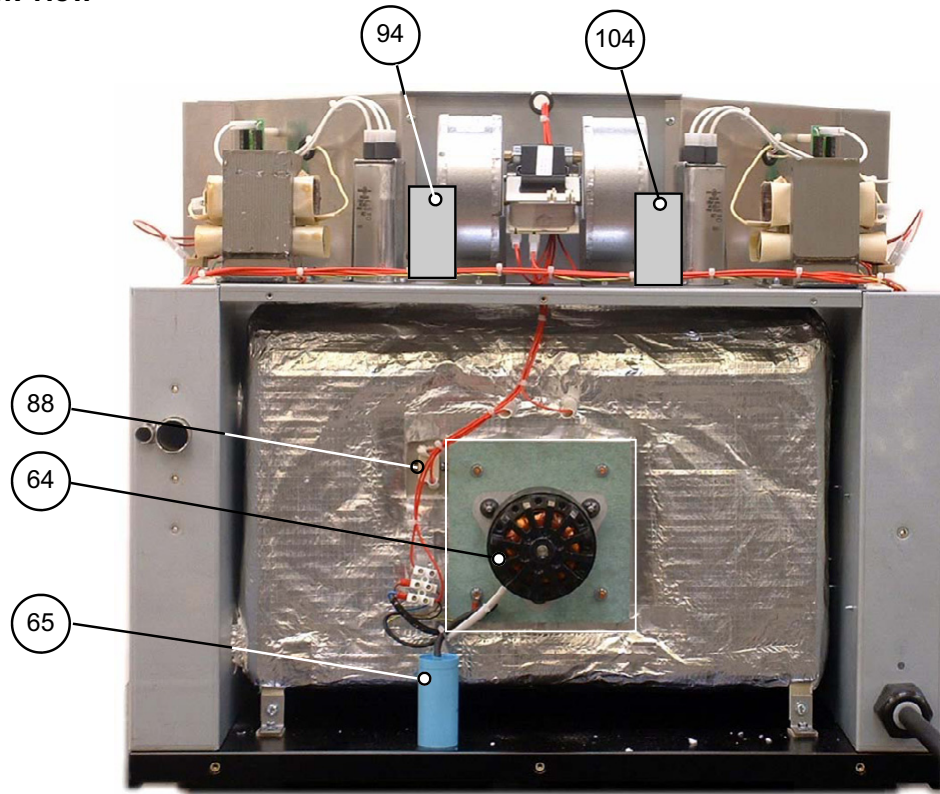

No	Description	208V	240V
64	Hot air motor assembly	10C0192	10C0192
65	Capacitor (motor start) 6 μ F	30Z1148	30Z1148
88	Overheat Safety Thermostat	30Z1024	30Z1024
94	Hot Air motor Resistor Assy	N/A	11C0341
104	Twin Blower Resistor Assy	N/A	11C0477

PRINCIPAL COMPONENTS

Door and cavity roof

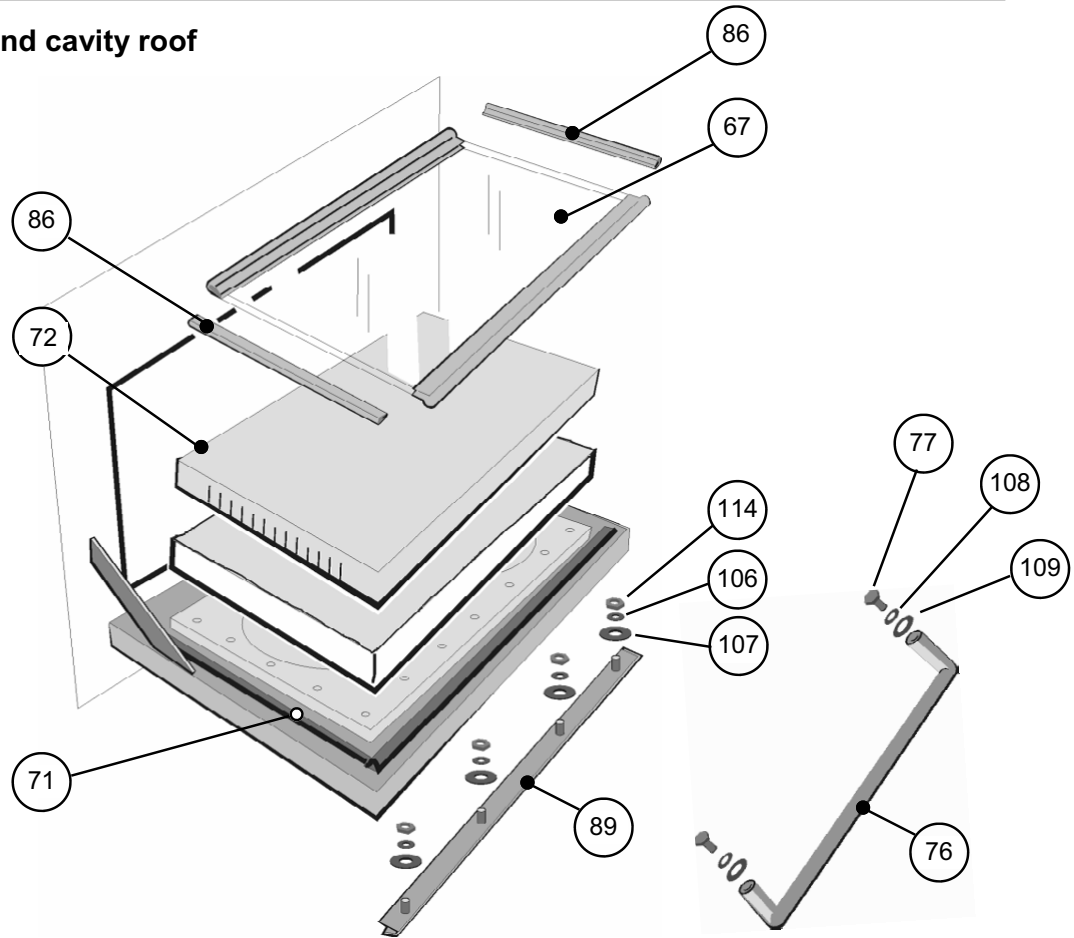

No	Description	208V	240V
53	M5 Hex/hd s/s Screw	101825	101825
67	Stirrer glass assy. (inc. long seals)	11C0319	11C0319
71	Door seal kit	11C0292	11C0292
72	Door choke	790007	790007
76	Door Handle Towel Rail	32Z1064	32Z1064
77	Bolt 1/4" 20 UNC 3/4" Hex	109050	109050
86	Cavity roof seal (short)	790052	790052
89	Door Handle	40C1020	40C1020
	Door Assembly Garland	11C0336	11C0336
93	Door Assembly Tim Hortons	11C0380	11C0380
	Door Assembly Unbranded	11C0418	11C0418
106	Flat Washer S/S M5 x 20	104036	104036
107	Nylon Washer	104250	104250
108	Spring Washer	31Z5005	31Z5005
109	Flat Washer S/S M6 x 20	104054	104054
117	Nut M4 S/S	31Z4015	31Z4015

PRINCIPAL COMPONENTS

External Parts and accessories

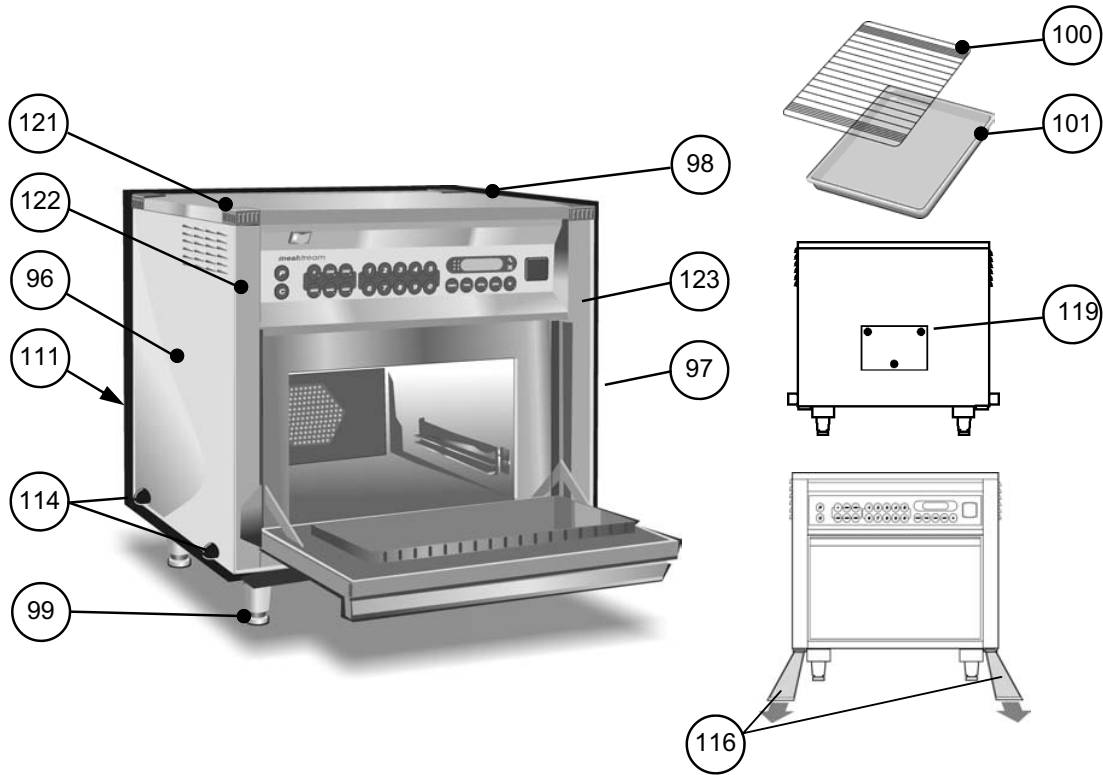

No	Description	All models before February 2004	All models after February 2004
96	Side Panel Left Side	790002	40C1182
97	Side Panel Right Side	790003	40C1183
98	Top Panel	790005	40C1181
99	Foot	32Z1052	32Z1052
100	Wire Rack	40C1011	40C1011
101	Crumb Tray	RBR290X02	RBR290X02
111	Rear Outer Panel	40C0951	40C1180
114	Side bumper	RMC6104	RMC6104
116	Air filter panel (removable)	40C0868	40C0868
119	Push fit bumper (Rear Panel)	31Z1187	31Z1187
121	Roof Corner cap	n/a	40C1113
122	Front pillar LH	n/a	40C1184
123	Front pillar RH	n/a	40C1185

PRINCIPAL COMPONENTS

Heater Element and Cavity parts

No	Description	208V	240V
57	Mesh washer	31Z5044	31Z5044
68	Heater element	40C0949	40C0948
69	Heater element cover plate	790047	790047
70	Baffle	11C0311	11C0311
85	Dome Nut	80X7025	80X7025
92	Shelf Support (Garland)	40C0950	40C0950
102	Hot Air Impeller	10C0236	10C0236
115	Shelf Support Tim Hortons	10C0174	10C0174
124	Shelf support fixing bolt	80T7133	80T7133

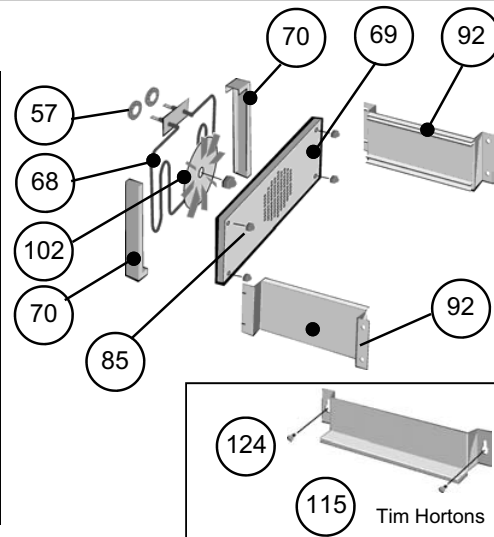

Electronic Control Panel Assembly

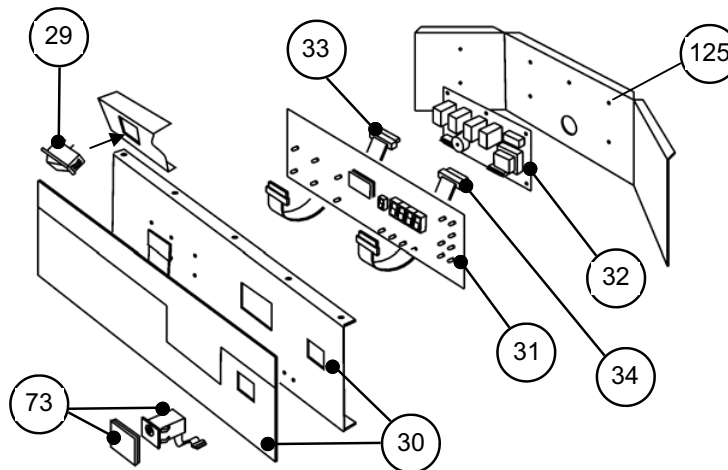

No	Description	208V	240V
29	On/Off Switch	30Z0503	30Z0503
30	Control Panel Assy with Menukey (except Tim Hortons)	11C0379	11C0379
31	Logic Board (except Tim Hortons)	11C0377	11C0377
32	Relay Board (except Tim Hortons)	11C0316	11C0212
33	AC Ribbon connector (6 way)	11M0116	11M0116
34	DC Ribbon connector (10 way)	11M0360	11M0360
73	MenuKey Assembly	10C0148	10C0148
125	PCB standoff	2243033	2243033

Tim Hortons
See page 16

Control Panel Assembly on ovens manufactured before February 2004

Control panels now supplied are for the new style casework and not compatible with older models. When replacing the control panel assembly remove the top trim/On-Off switch metal panel from the existing control panel and substitute this for the top trim on the replacement unit.

TIM HORTONS CONTROL PANEL

US/ English

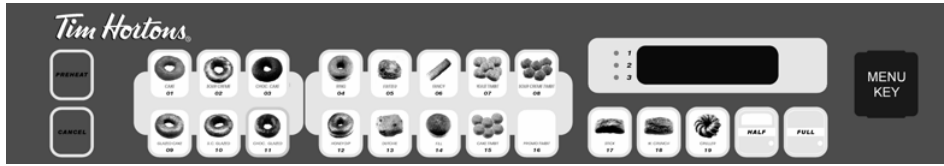

No	Description	208V	240V
30	Control Panel Assy with Menukey	11C0332	11C0332
31	Logic Board	11C0331	11C0331
32	Relay Board	11C0316	11C0212

US/ English 1/4 Load

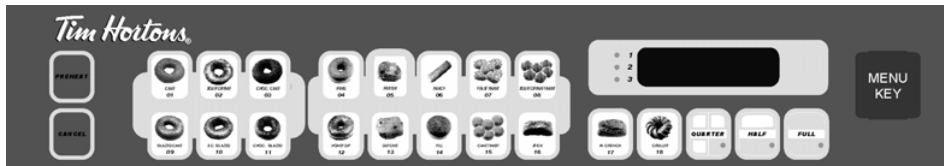

No	Description	208V	240V
30	Control Panel Assy with Menukey	11C0412	11C0412
31	Logic Board	11C0411	11C0411
32	Relay Board	11C0402	11C0403

French Canadian

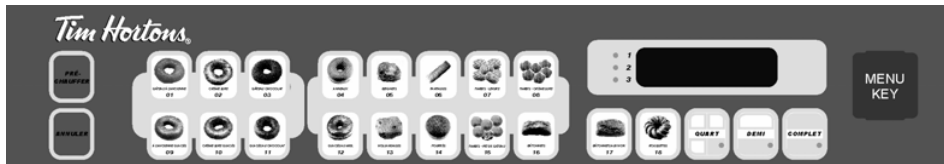

No	Description	208V	240V
30	Control Panel Assy with Menukey	11C0413	11C0413
31	Logic Board	11C0411	11C0411
32	Relay Board	11C0402	11C0403

Unbranded

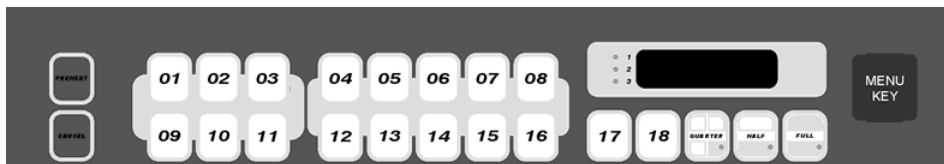

No	Description	208V	240V
30	Control Panel Assy with Menukey	11C0414	11C0414
31	Logic Board	11C0411	11C0411
32	Relay Board	11C0402	11C0403

PRINCIPAL COMPONENTS

(not shown in main views)

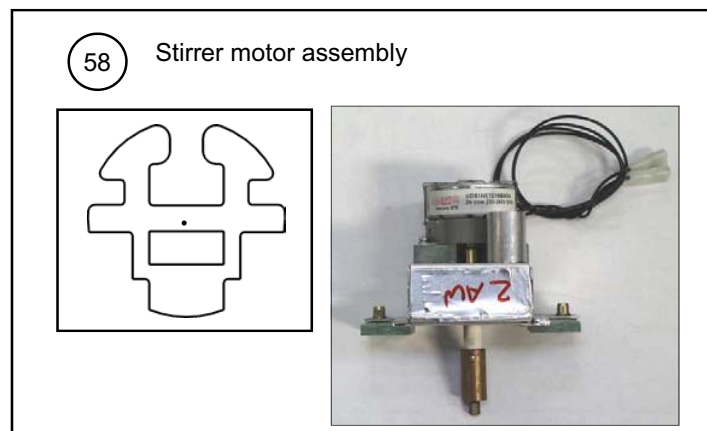
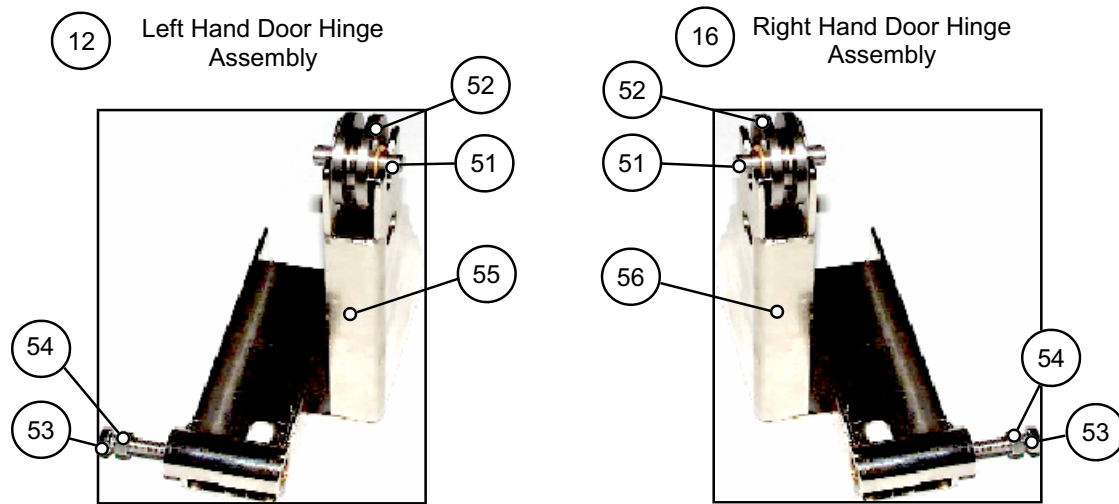

No.	Description	All models
12	Door Hinge Assembly LH	11C0167
16	Door Hinge Assembly RH	11C0166
51	Pin	790027
52	Roller	40C0752
53	M5 Hex/hd s/s Screw	101825
54	M5 stainless steel Nut	80X7003
55	LH Hinge bracket	790024
56	RH Hinge bracket	790025
58	Stirrer motor assembly	11C0324

PRINCIPAL COMPONENTS

Input wiring details

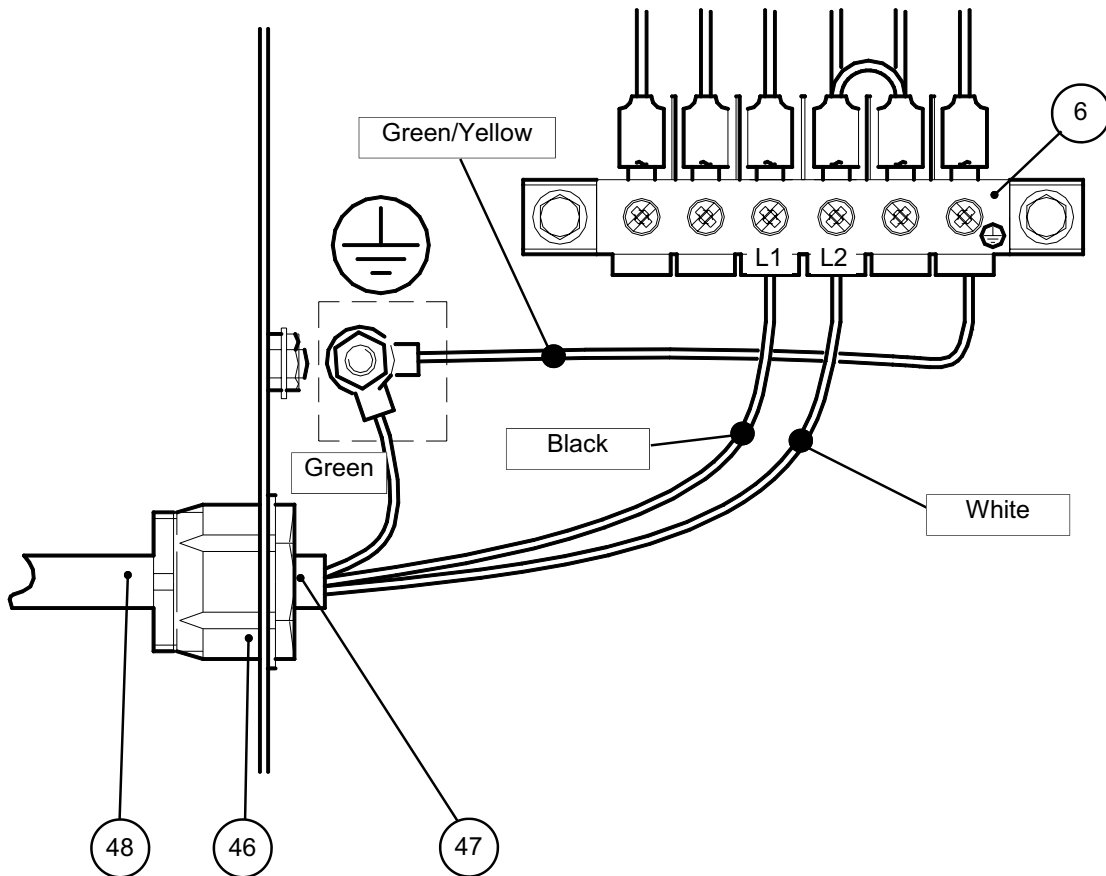

No.	Description	All models
6	Electrical Supply Terminal Block	31Z0149
46	Cable Gland	31Z0500
47	Gland Nut	31Z0499
48	Electrical Supply Cord 3 Core	30Z1162
91	Electrical Supply Plug 50Amp (Canada)	31Z0298

Hot Air Motor connections and Wiring

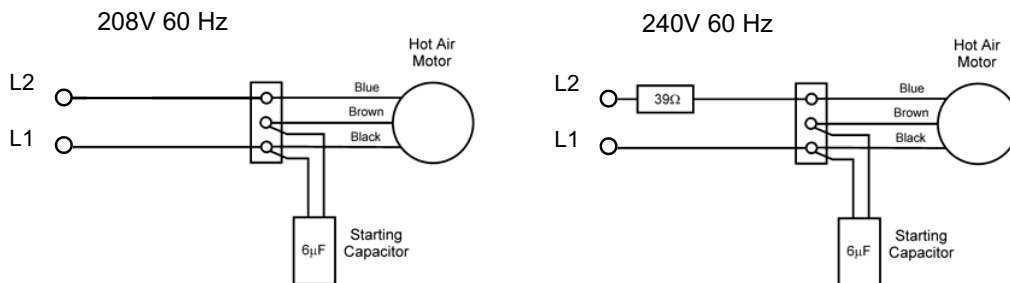

PRINCIPAL COMPONENTS: Part Number Identification Chart 1

No	Description	Part No		Page No
		208V	240V	
1	Fuse holder	30Z0231	30Z0231	9
1A	Fuse 10 amp	30Z0217	30Z0217	9
2	Fuse holder	30Z0231	30Z0231	9
2A	Fuse 10 amp	30Z0217	30Z0217	9
3	Fuse holder	30Z0285	30Z0285	9
3A	Fuse 1 amp	30Z0957	30Z0957	9
4	Fuse holder	30Z1178	30Z1178	9
4A	Fuse 20 amp	30Z1177	30Z1177	9
5	Fuse holder	30Z1178	30Z1178	9
5A	Fuse 20 amp	30Z1177	30Z1177	9
6	Electrical supply terminal block	31Z0149	31Z0149	9/18
7	Filter (Heater circuit)	30Z0997	30Z0997	9
8	Filter (Microwave circuit)	30Z0997	30Z0997	9
9	Door spring Modification Kit ^A	10C0177	10C0177	9/10
	Door spring(Long)	40C1141	40C1141	9/10
10	Door arm stop assembly ^C	11C0279	11C0279	9/10
11	Microswitch (Primary)	30Z0240	30Z0240	9
12	Door hinge assembly (LH)	11C0167	11C0167	9/17
13	Door arm assembly	11C0300	11C0300	9/10
14	Microswitch (Monitor)	30Z0240	30Z0240	9
16	Door hinge assembly (RH)	11C0166	11C0166	10/17
17	Microswitch (Secondary)	30Z0240	30Z0240	10
20	Steam pipe S/S	790046	790046	10
21	Steam vent guard	790061	790061	10
22	Temperature sensor	50E123	50E123	10
23	Magnetron	30Z1171	30Z1171	11
24	Resistor 470 R	30Z0283	30Z0283	11
25	HT diode	11C0266	11C0266	11
26	Capacitor 0.88µf (2300V) ^D	30Z0861	30Z0861	11
	Capacitor 0.88µf (2500V) Kit	10C0172	10C0172	11
27	Transformer (Multi-tap) ^E	30Z1230	30Z1230	11
28	Twin blower motor	30Z1145	30Z1067	11
29	On/Off Switch	30Z0503	30Z0503	15
30	Control Panel Assembly (Except Tim Hortons)	11C0379	11C0379	15
	Control Panel Assembly US Tim Hortons	11C0412	11C0412	16
	Control Panel Assy. French C. Tim Hortons	11C0413	11C0413	16
	Control Panel Assy. UnBranded Tim Hortons	11C0414	11C0414	16

Note A: Ovens before June 2003

Note C: For ovens later than May 2005 See Appendix 7

Note D: This Capacitor is replaced with [30Z1251](#) 0.88µf 2500V and 2 x 88mm clips [30Z0521](#) included in a service kit Part No. [10C0172](#)

Note E: All transformers are now replaced by the Multi-tap type Part No. [30Z1230](#)

PRINCIPAL COMPONENTS: Part Number Identification Chart 2

No	Description	Part No		Page No
		208V	240V	
31	Logic Board (Except Tim Hortons)	11C0377	11C0377	15
31	Logic Board Tim Hortons	11C0411	11C0411	15
32	Relay Board (except Tim Hortons)	11C0316	11C0212	15
33	AC Ribbon connector (6 way)	11M0116	11M0116	15
34	DC Ribbon connector (10 way)	11M0360	11M0360	15
46	Cable Gland	31Z0500	31Z0500	18
47	Gland Nut	31Z0499	31Z0499	18
48	Mains Cable 3 Core	30Z1162	30Z1162	18
51	Pin	790027	790027	17
52	Roller	40C0752	40C0752	17
53	M5 Hex/hd s/s Screw	101825	101825	13/17
54	M5 stainless steel Nut	80X7003	80X7003	17
55	LH Hinge bracket	790024	790024	17
56	RH Hinge bracket	790025	790025	17
57	Mesh washer	31Z5044	31Z5044	14
58	Stirrer motor assembly	11C0162	11C0162	17
59	Rubber stop	31Z1150	31Z1150	10
60	25mm OD Flexible conduit	314402	314402	11
61	20mm OD Flexible conduit	314401	314401	11
62	Capacitor clip (88mm)	31Z0521	31Z0521	11
63	Filter	30Z0997	N/A	11
64	Hot air motor assembly Kit	10C0192	10C0192	12
65	Capacitor (Motor starter)	30Z1148	30Z1148	12
67	Stirrer glass Assy. (Inc. long seals)	11C0319	11C0319	13
68	Heater element	40C0949	40C0948	14
69	Element cover plate	790047	790047	14
70	Baffle	11C0311	11C0311	14
71	Door seal kit	11C0292	11C0292	13
72	Door choke	790007	790007	13
73	MenuKey Assembly	10C0148	10C0148	15
76	Handle	32Z1064	32Z1064	13
77	Bolt 1/4" 20 UNC 3/4" Hex	109050	109050	13
85	Dome Nut	80X7025	80X7025	13
86	Cavity roof seal (short)	790052	790052	13
87	Magnetron Thermal Trip	2571016	2571016	10
88	Cavity Overheat Thermostat	30Z1024	30Z1024	12
89	Door Handle	40C1020	40C1020	13
90	Cavity Vent Pipe	40C1013	40C1013	10
91	Electrical Supply Plug (50A Canada)	31Z0298	31Z0298	18
92	Shelf Support (Garland)	40C0950	40C0950	13

PRINCIPAL COMPONENTS: Part Number Identification Chart 3

No	Description	Part No		Page No
		208V	240V	
93	Door Assembly Garland	11C0336	11C0336	13
	Door Assembly Tim Hortons	11C0380	11C0380	13
	Door Assembly Unbranded	11C0418	11C0418	13
94	Hot Air Motor Resistor Assy	N/A	11C0341	12
95	Diode assy with leads	11M0417	11M0417	10
96	Side Panel Left Side	790002	790002	14
97	Side Panel Right Side	790003	790003	14
98	Top Panel	790005	790005	14
99	Foot	32Z1052	32Z1052	14
100	Wire Shelf	40C1011	40C1011	14
101	Crumb Tray	RBR290X02	RBR290X02	14
102	Hot Air Motor Impellor	10C0236	10C0236	14
104	Twin Blower Resistor Assy	N/A	11C0477	12
106	Flat Washer S/S M5 x 20	104036	104036	13
107	Nylon Washer	104250	104250	13
108	Spring Washer	31Z5005	31Z5005	13
109	Flat Washer S/S M6 x 20	104054	104054	13
110	Door Spacer Kit	10C0171	10C0171	28
111	Rear Outer Panel	40C0951	40C0951	14
112	Internal Filter LHS	40C0962	40C0962	9
113	Internal Filter RHS	40C1080	40C1080	10
114	Side Bumper	RMC6104	RMC6104	14
115	Shelf Support Tim Hortons	10C0174	10C0174	14
116	Air Filter Panel (removable)	40C0868	40C0868	14
117	Nut M4 S/S (Door Handle)	31Z4015	31Z4015	13
118	Microswitch support bracket	40C0851	40C0851	9/10
119	Push fit bumper (rear panel)	31Z1187	31Z1187	14
121	Roof Corner Cap	n/a	40C1113	14
122	LH Front pillar	n/a	40C1184	14
123	RH Front pillar	n/a	40C1185	14
124	Shelf support fixing bolt	80T7133	80T7133	15
125	PCB standoff	2243033	2243033	15
126	Door arm stop assembly	11C0480	11C0480	Appendix 7
127	Adj. Microswitch support bracket	40C1233	40C1233	Appendix 7

PROCEDURE FOR MICROWAVE LEAKAGE TEST (1)

Warning

Check for radiation leakage after servicing. Should the leakage be more than 4mW/cm² Inform Garland service centre immediately. After repairing or replacing any radiation safety device, keep a written record for future reference, as required by D.H.H.S. and Health and Welfare Canada regulation.

This requirement must be strictly observed. In addition, the leakage reading must be recorded on the service repair documentation while in the customer's premises.

Please Note

DO NOT attempt to carry out the following procedure unless you have the following tools.

Tools required for microwave leakage test

600ml glass beaker
Supply of cold water
Microwave leakage meter

Tim Hortons

To carry out this test the Icon Pads need to be switched to
ENGINEERING MODE PROGRAMS
See Appendix 1

Read and understand all of these notes and procedure before carrying out this operation.

Note before measuring.

- Make sure that the survey meter you are using has been calibrated and is suitable for measuring frequencies of 2,450 MHz.
- Do not exceed meter full scale deflection, leakage meter should initially be set to the highest scale, then adjusted down as necessary to ensure that low readings are measured on the most sensitive range.
- To prevent false readings, hold the probe on the grip provided and move along the areas indicated on the following page. The probe should be moved at 1 inch/second (2.5cm).
- With any casework removed the leakage should not exceed 4mW/cm².
- When measuring the leakage, always hold the probe at 2" (50mm) from the test area using the probe supplied with the instrument.
- Always hold the probe at right angles to the oven and point of measurement.

Procedure

- 1) Place 275ml of cold water in the 600ml glass beaker.
- 2) Place the 600ml glass beaker in the centre of oven.
- 3) Close the door and set time for 30 seconds then press Power pad 100% (change water every 30 seconds to prevent boiling).
Tim Hortons: In ENGINEERING MODE (see Appendix 1) press Pad 01 then any Load pad (QUARTER, HALF, FULL) watch time display and open door at 30 seconds.
- 4) Set the leakage meter to the appropriate scale/range.
- 5) Move the survey meter probe along the areas indicated in (Figures 1 to 4 page 23).
- 6) Remember to change the water after 30 second since water that boils will result in inaccurate readings.

PROCEDURE FOR MICROWAVE LEAKAGE TEST (2)

- Readings must be **below** 4mW/cm². If a level greater than 4mW/cm² is observed, this should be reported to Garland Service Division immediately.
- In any case, notes should be kept of the leakage that is observed. In terms of level and position on the oven. This should be kept with the service documentation.

Control Panel - Figure 2
 Door Perimeter - Figure 2
 Rear and Side Covers - Figure 1, 3 & 4
 Left & right Side Air Filters. - Figure 3 & 4

Test for microwave leakage at all points marked with a

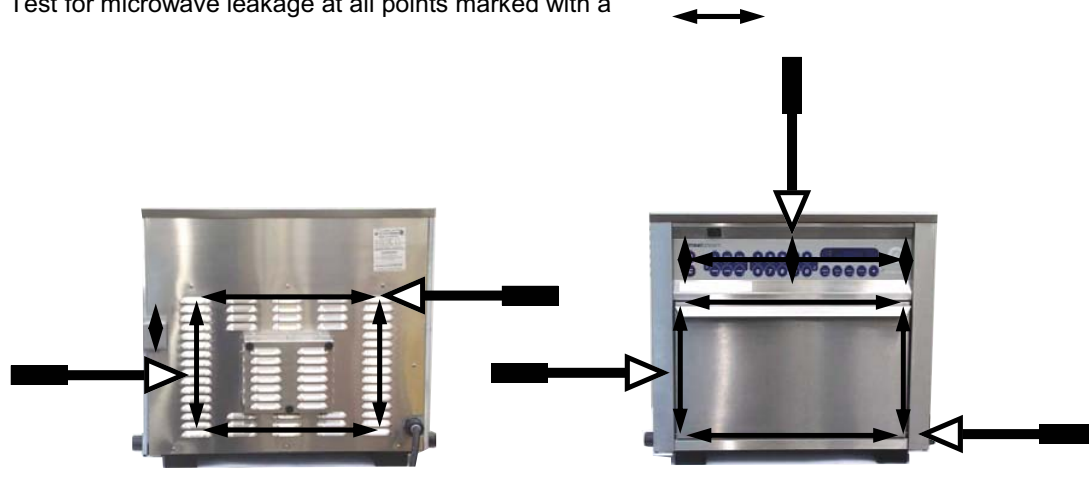

Fig. 1

Fig. 2



Fig. 3

Fig. 4

PROCEDURE FOR POWER OUTPUT MEASUREMENT

The power output specification, 1425W on this model is established under IEC 705 standard method. This method is only workable in Laboratory controlled conditions.

An approximate method is as follows:

Tim Hortons Ovens

To carry out this test the Icon Pads need to be switched to ENGINEERING MODE PROGRAMS
See Appendix 1

- 1) Fill one beaker (glass or plastic) with one litre (1.78 pints) of tap water (at about 68°F/ 20°C) and measure the water temperature.
(Use a thermometer with a $\frac{1}{10}$, 0.1 degree gauge).
- 2) Place the beaker in the centre of the cavity.
- 3) **General Market Models**
Set Time to 1 minute 3 seconds and Power to 100%
Wait until the counter reaches zero.

Tim Hortons Ovens

With the oven in ENGINEERING MODE (see Appendix 1) Press Pad 01 (Cake) and any Load Pad (Quarter, Half, Full) Wait until the counter reaches zero.

- 4) Take the beaker out immediately stir the water with a plastic implement and measure the water temperature.
- 5) Calculate the temperature rise of water in the beaker. The temperature rise of the water should be within the following range:

Temperature Rise

27°F (15°C)	Minimum
36°F (20°C)	Maximum

Power Output is affected by the line voltage under load.

For correct Power Output measurement, the line voltage under load must be correct.

PROCEDURES FOR PRINCIPAL COMPONENTS TEST (1)

1. Power Transformer Test

You will need:

- A Digital Multi-meter (D.M.M.)
- A Megger or similar resistance meter using 500V d.c.

WARNING: High voltages and large currents are present at the High Voltage Capacitor. It is very dangerous to work near this part when the oven is on. **NEVER** make any voltage measurements at the High Voltage circuits, including the magnetron filament.

WARNING: Even when the oven is not cooking, the High Voltage Capacitor has High Voltages present because of the Soft Start circuit. Isolate the oven before testing.

See Safety Code (Page 4)

- 1 Isolate the oven from the mains supply.
- 2 Ensure that the High Voltage Capacitor is discharged before commencing work.
- 3 Remove all connections from the Power Transformer.
- 4 Using a D.M.M., check the resistance of the windings. Results should be as follows:

a	Mains winding between tags	Approx. 1.1 Ω
b	High Voltage winding	Approx. 60 Ω
c	Filament winding between terminals	Less than 1 Ω

- 5 Using a Megger, test the insulation resistance between:

Primary winding and chassis	Pass if over 10 M Ω
Filament winding and chassis	Pass if over 10 M Ω

One end of the High Voltage winding is connected to the chassis, so this is not tested.

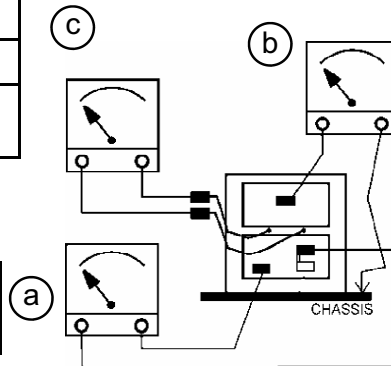

2. High Voltage Capacitor Test

You will need:

- A Digital Multi-meter (D.M.M.)
- A Megger or similar resistance meter using 500V d.c.

WARNING: High voltages and large currents are present at the High Voltage Capacitor. It is very dangerous to work near this part when the oven is on. **NEVER** make any voltage measurements at the High Voltage circuits, including the magnetron filament.

WARNING: Even when the oven is not cooking, the High Voltage Capacitor has High Voltages present because of the Soft Start circuit. Isolate the oven before testing.

See Safety Code (Page 4)

1. Isolate the oven from the mains supply.
2. Ensure that the High Voltage Capacitor is discharged before commencing work.
3. Remove all connections from the High Voltage Capacitor.
4. Using a D.M.M., check for continuity between the terminals & compare results with table on next page.

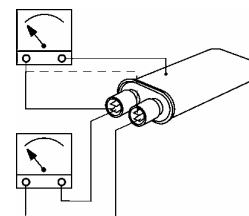

PROCEDURES FOR PRINCIPAL COMPONENTS TEST (2)

(High Voltage Capacitor Test continued, ensure steps 1-4 on previous page have been completed)

Between Terminals	Pass if approximately 10 MΩ
Between Terminals and Case	Pass if open circuit

5. Using a Megger, test the insulation resistance between the terminals and the case.

Between Terminals and Case	Pass if over 100 MΩ
----------------------------	---------------------

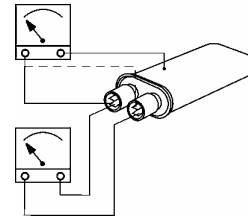

3. High Voltage Rectifier Test

You will need:

A Megger or similar resistance meter using 500V d.c.

WARNING: High voltages and large currents are present at the High Voltage Capacitor. It is very dangerous to work near this part when the oven is on. **NEVER** make any voltage measurements at the High Voltage circuits, including the magnetron filament.

WARNING: Even when the oven is not cooking, the High Voltage Capacitor has High Voltages present because of the Soft Start circuit. Isolate the oven before testing.

See Safety Code (Page 4)

1. Isolate the oven from the mains supply.
2. Ensure that the High Voltage Capacitor is discharged before commencing work.
3. Remove all connections from the High Voltage Rectifier.
4. Using the Megger, test for continuity in both directions. Compare results with the table.

Open Circuit both ways	FAIL
Conducts one way only	PASS
Short Circuit both ways	FAIL
Conducts one way, leaks the other	FAIL

4. Magnetron Test

You will need:

A Megger or similar resistance meter using 500V d.c.

A Magnetron can be tested for an open filament or a short circuit by carrying out a continuity check.

WARNING: High voltages and large currents are present at the High Voltage Capacitor. It is very dangerous to work near this part when the oven is on. **NEVER** make any voltage measurements at the High Voltage circuits, including the magnetron filament.

WARNING: Even when the oven is not cooking, the High Voltage Capacitor has High Voltages present because of the Soft Start circuit. Isolate the oven before testing.

See Safety Code (Page 4)

1. Isolate the oven from the mains supply.
2. Ensure that the High Voltage Capacitor is discharged before commencing work.
3. Remove all connections from the Magnetron.
4. A continuity check across the Filament terminals should be 1ohm or less
5. A continuity check between each filament terminal and the metal outer should read open.

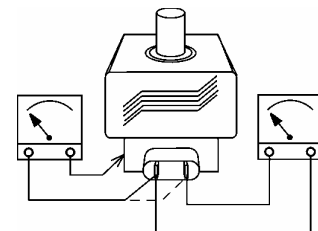

PROCEDURE FOR DOOR INTERLOCK ADJUSTMENT AND TEST (1)

The door on the Mealstream oven is monitored by three microswitches. These are used in the conventional "Primary, Secondary and Monitor" switch arrangement shown below. The switches operate as follows:

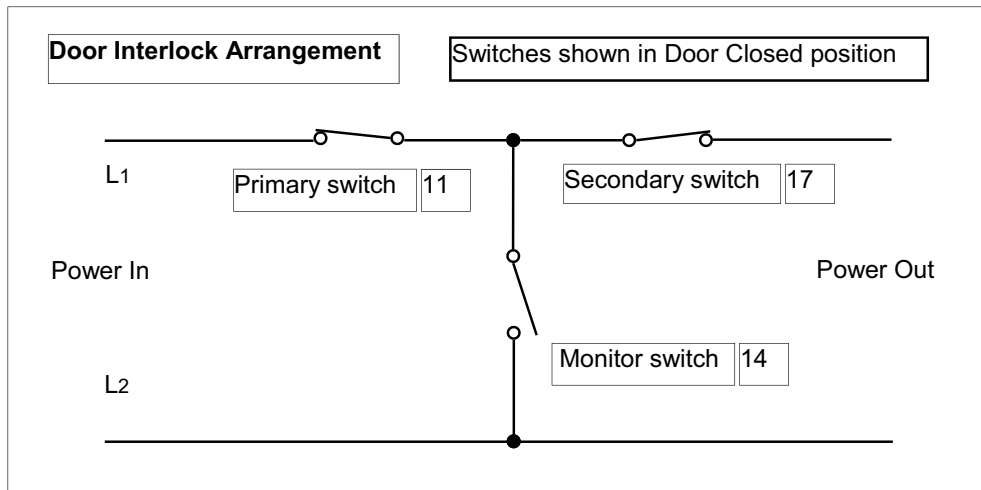

1. **Monitor switch (14 ,Top left-hand Side)**. The Monitor switch will produce a short circuit across the mains supply if the Primary interlock switch is faulty, when the door is opened, thus blowing the microwave fuse and rendering the oven inoperative.
2. **Primary Interlock (11 , Bottom left-hand) and Secondary Interlock (17 , Bottom right-hand) Switches**. Operate simultaneously. The Primary switch will cut off the microwave emissions from the oven when the door is opened by breaking the electrical supply circuit to the transformers. The Secondary interlock switch will cut off the microwave emission if the Primary switch have failed.

Note:

If operation of the Monitor switch has caused the Microwave Fuse to blow, the Primary and Monitor microswitches must be changed, as they may have been damaged by the high short-circuit currents involved.

PROCEDURE FOR DOOR INTERLOCK ADJUSTMENT AND TEST (2)

Please Note
DO NOT attempt to carry out the following procedure unless you have the following tools and parts.

Continuity Meter			
	Spacer	No. required	Part No.
Door Spacer Kit Part No. 10C0171	S10 Door Spacer 10mm	2	40C1119
	S5 Door Spacer 5mm	2	40C1118
	S1 Door Spacer 1mm	2	40C1114

WARNING

Before starting this test procedure please make sure that the oven is disconnected from the electrical supply and that the oven power switch (ON/OFF) is in the OFF position.

After each step check that the interlocks are operating in the correct order using a continuity meter.

See Safety Code (Page 4)

Disconnect the microswitches and check for the continuity of the switches with a continuity meter

Step 1: Set the interlock so that they activate in the following order.

When closing the door.

Interlock	Order
SW1 (Monitor)	1 st
SW2 (Primary)	2 nd Note both SW2 and SW3 activate together
SW3 (Secondary)	2 nd Note both SW2 and SW3 activate together

When opening the door.

Interlock	Order
SW1 (Monitor)	3 rd
SW2 (Primary)	1 st Note both SW2 and SW3 activate together
SW3 (Secondary)	1 st Note both SW2 and SW3 activate together

PROCEDURE FOR DOOR INTERLOCK ADJUSTMENT AND TEST (3)

Step 2: Insert S10 10mm spacer into door.
(See figure 1 below for inserting spacer correctly).

Interlock	Order
SW1 (Monitor)	CLOSED
SW2 (Primary)	OPEN
SW3 (Secondary)	OPEN

Step 3: Remove S10 10mm spacer and insert S1 1mm spacer into the door and close the door.

Interlock	Order
SW1 (Monitor)	OPEN
SW2 (Primary)	CLOSED
SW3 (Secondary)	CLOSED

Step 4: Remove S1 1mm spacer and insert S5 5mm spacer into the door and close the door.

Interlock	Order
SW1 (Monitor)	OPEN
SW2 (Primary)	OPEN
SW3 (Secondary)	OPEN

**If an oven fails this sequence
then check the microswitches are functioning correctly and repeat steps 1 to 4.**

After carrying out this procedure make sure that the interlock monitor switch is properly connected according to the circuit diagram on pages 44-46.

Figure 1

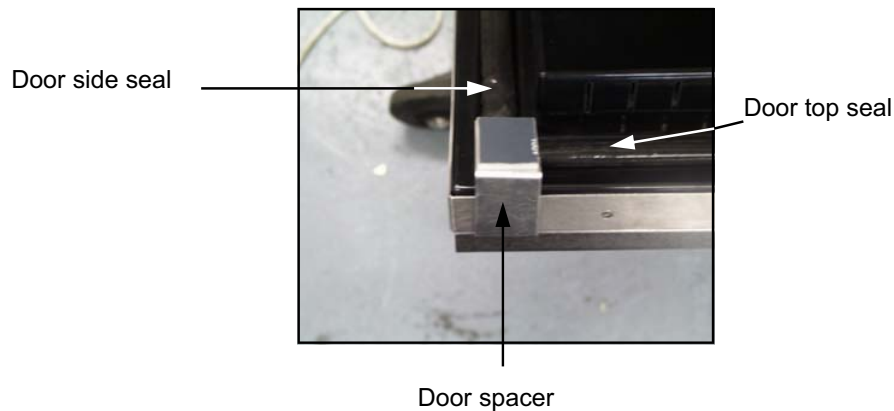

The door spacer must always be located on the point where the side seals and top seals meet.



Please note.

It is very important after completing this procedure to carry out a microwave leakage test procedure. See pages 22-23.

PROCEDURE FOR BUILDING AND FITTING MEALSTREAM DOOR (1)

Parts required for door fitting

Please Note
DO NOT attempt to carry out the following procedure
unless you have the following tools and parts.

Item No.	Description	Part No.	Quantity
1	RHS door hinge assy	11C0166	1
2	M5 x 10mm	101820	4
3	M5 flat washer	31Z5008	29
4	M5 shake proof washer	31Z5012	29
5	Spacer	790084	2
6	M5 x 16mm hex screw	101876	2
7	Door frame assy	11C0303	1
8	LHS door hinge assy	11C0167	1
9	Door arm assy	11C0300	2
10	Door arm Pivot Pin	790010	2
11	Door spring	520000 or 40C1141	2
12	Door Stop	40C0854	2
13	Door stop spring clip	31Z5047	2
14	M5 stainless steel full nut	80X07003	23
15	Door seal set of 4	11C0292	1
16	CAF 30 Adhesive	31Z0186	As required
17	Door insulation set	40C0942	1
18	Outer Door Skin	Check Oven Model	1
19	M3 counter sunk screw	31Z3094	7
20	Choke Plate	790007	1
21	SPACER KIT	10C0171	1

Tools required for door fitting

M5 Nut runner	Door Spacers S325 & 3 off S215
Flat head screw driver	Long nose pliers
5mm open-ended spanner	Adhesive skeleton gun
Engineers rule	

PROCEDURE FOR BUILDING AND FITTING MEALSTREAM DOOR (2)

1. Visually check all parts to be used.
2. Fit right hand side (RHS) Hinge assy. to base assy. loosely fit in place with bottom bolts, 2 off M5 x 10mm, 2 off M5 flat washer, 2 off M5 shockproof washer.
Fit a spacer to fill gap between Hinge assy and Inner side panel, loosely fit spacer in place with 1 off M5 bolt x 16mm, 1 off M5 flat washer, 1 off M5 shakeproof washer.

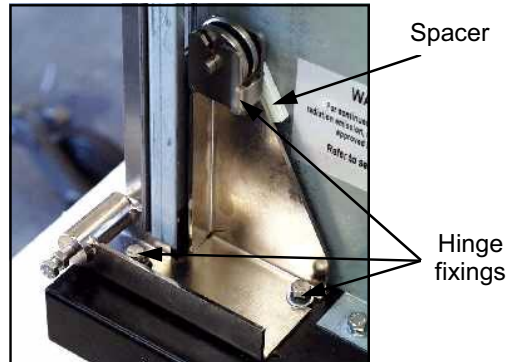

3. Insert (RHS) Pivot pin of door frame into (RHS) Hinge assy. Place door frame against cavity face and slide on (LHS) Hinge assy to the (LHS) Pivot pin of door frame,

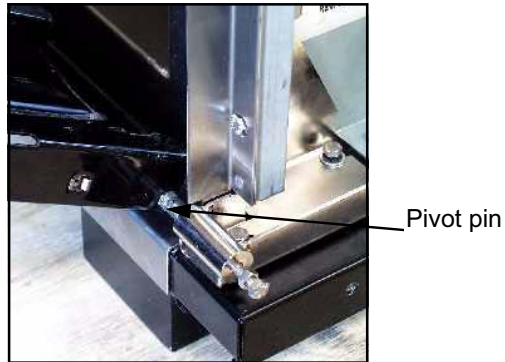

4. Fit Left hand side (LHS) Hinge assy to base assy, loosely fit in place with bottom bolts, 2 off M5 x 10mm, 2 off M5 flat washer, 2 off M5 shockproof washer. Fit spacer to fill gap between Hinge assy. and Inner side panel, loosely fit spacer in place with 1 off M5 bolt x 16mm, 1 off M5 flat washer, 1 off M5 shakeproof washer.

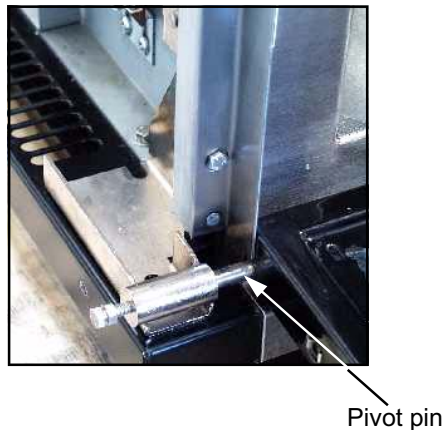

5. With the door frame held firmly against cavity tighten fixing bolts to secure (RHS) and (LHS) Hinge Assy to base.

Note:

Do not tighten bolt securing hinge to inner side panel.

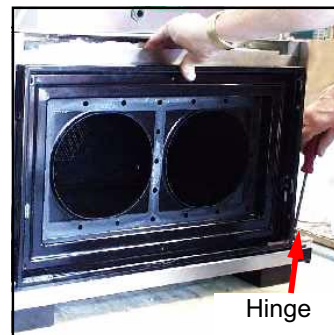

PROCEDURE FOR BUILDING AND FITTING MEALSTREAM DOOR (3)

6. Fit (RHS) and (LHS) door arm assemblies through slots in cavity and insert door arm pivot pins through door arms into door frame.



7. Ensure the door frame is fitted central by using the following method:

Measure the distance between the side of the door and the edge of the pin location hole on each side with the door in the closed position. Add these two measurements together and divide by 2.

Adjust hinge adjustment bolt so that the door is the distance calculated from the side of the door to the edge of the pin location hole and lock in position with lock nut.

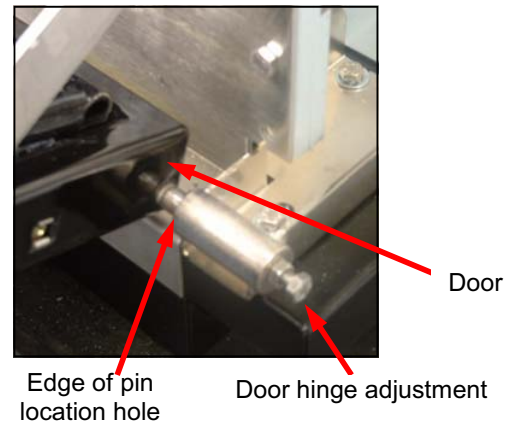

8. With both door arms fitted and the door in the open position, check the door is level and if necessary apply gentle pressure down on door to level door. Tighten the top securing bolts on (LHS) & (RHS) hinges while holding door down.

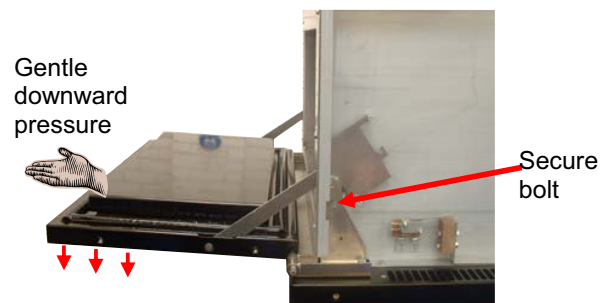

9. Fit door springs to door arms and to the hook at base of inner side panels. Check operation of door and remove both springs.

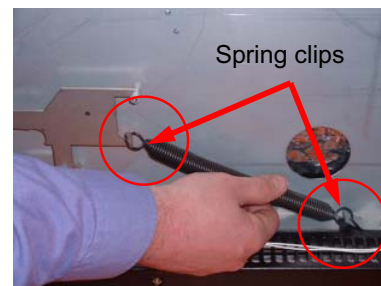

PROCEDURE FOR BUILDING AND FITTING MEALSTREAM DOOR (4)

10. Fit door shim plate Pt. No. 40C1084. Position door choke to door frame assy making sure it is in the correct orientation (the top of door choke is marked with 'T' on the underside).

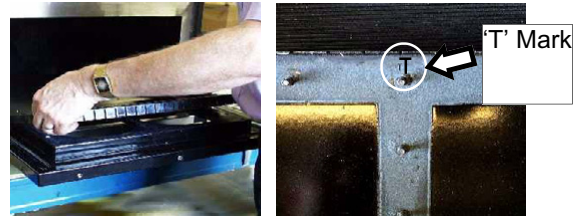

Stage 1

11. Loosely fit the choke plate in the three central locations using M5 full nut, M5 Ext Shake-proof washer, 3x M5 plain washer ensure that the studs are central in the holes in the shim plate and door choke plate.

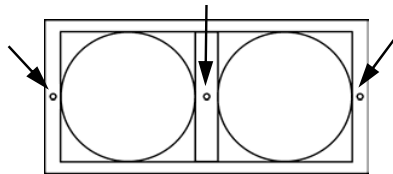

Stage 2

12. To set the position of the door choke plate tape choke spacer S325 to the cavity base (A) and choke spacers S215 to the top and each side of the door choke (B, C & D)

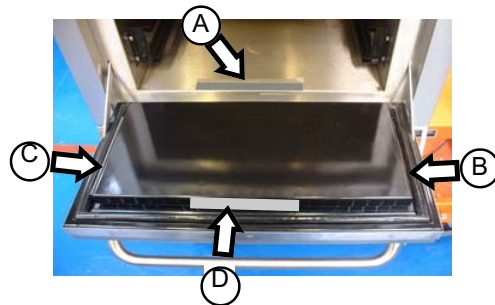

A	Cavity base
B	Choke fingers Right
C	Choke fingers Left
D	Choke fingers top

Close the door and centralise the door choke. Push down on the choke plate and secure the three central locations (shown in yellow in diagram)
Fit the remaining studs with 20x M5 Mag-nuts and tighten fixings evenly.

Note: See diagram for recommended tightening sequence.

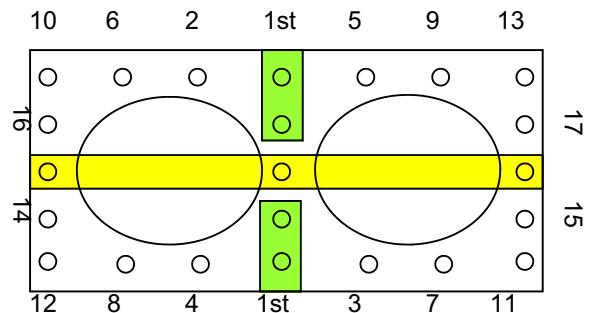

Yellow are tightened at setup of choke, green are tightened after initial setup and the remaining nuts are tightened in numerical order.

13. Remove spacing pieces and check door operation.

PROCEDURE FOR BUILDING AND FITTING MEALSTREAM DOOR (5)

12. Fold the square piece oven insulation in half and place it in the recess in the oven door. Place the rectangular piece into the remainder of the door (foil facing out).



Stage 1



Stage 2

13. Place the outer skin over the door frame assembly and fix around the LHS, RHS & top using 7 of M3x12 counter sunk screws around the LHS, RHS and top of the door. Squeeze skin onto door frame before tightening up screws to ensure snug fit.
See matrix below for door skin assembly to be used.

Grease up door arms where contact is made with roller.



Please note.

It is very important after completing this procedure, to carry out a Door interlock adjustment and test procedure. See pages 27-29.

PROCEDURE FOR REPLACING DOOR SEAL ASSEMBLY (1)

Parts required for replacing carbon loaded door seals

Please Note
DO NOT attempt to carry out the following procedure unless you have the following tools and parts.

Item	Description	Part Number	Quantity
1	Door seal set of 4	11C0292	1
2	CAF 30 (Black)	31Z0186	As required

Tools required for replacing carbon loaded door seals

Long nose pliers

Adhesive skeleton gun

Flat head screw driver



Please note.

Before proceeding with this procedure ensure that the oven is disconnected from the power supply.
If the oven has been operating recently please allow time for the oven to cool.

Removing Door seal

- 1 Open the oven door.
- 2 Use a pair of long nose pliers to unclip one end of the seal. (See figure 1 page 36)
- 3 Peel back the door seal assembly and unclip at the other end. (See figure 2 page 36)
- 4 Remove the residue CAF 30 adhesive with a flat head screw driver. (See figure 3 page 36)
- 5 Visually inspect the vitreous enamel to ensure that it is undamaged.

Fitting a New Seal

- 1 Clip on end of the door seal in place. Using a pair of long nose pliers, stretch the door seal and connect the other end in place. (See figure 4, 5 & 6 page 36)
- 2 Visually inspect that the door seal is sitting in the rebate provided.
- 3* **Perform door interlock set-up procedure (See page 27-29)**
- 4* **Perform a microwave leakage test procedure. (See page 22-23)**
- 5 Lift the seal and applied a thin line of CAF 30 adhesive along the length of the rebate and push the seal down. (See figure 7 page 36)
- 6 Seal the ends of the door seal with CAF 30 (See figure 8 page 36)
Leave the door in the open position to allow the adhesive to set.

*** It is very important to carry out these procedures**

PROCEDURE FOR REPLACING DOOR SEAL ASSEMBLY (2)

Figure 1



Figure 2



Figure 3



Figure 4

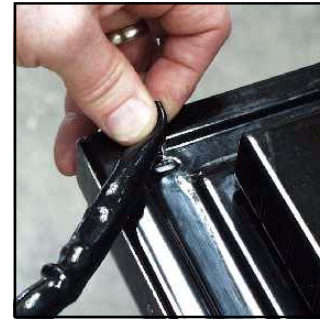

Figure 5



Figure 6



Figure 7



Figure 8



Please note.

It is very important after completing this procedure, to do a Door interlock adjustment and test procedure. See pages 27-29.

PROCEDURE FOR REMOVING SHELF RUNNERS AND ELEMENT COVER PLATE

Please Note:
DO NOT attempt to carry out the following procedure unless you have the following tools.

Tools required for removing shelf runners and element cover plate.

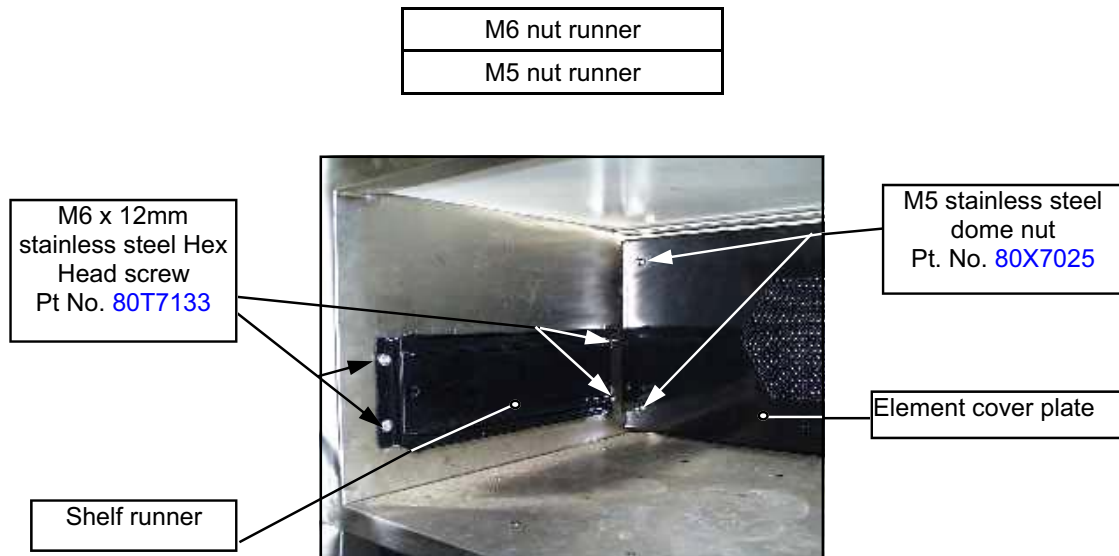

1. Loosen the rear fixings screws of both shelf runners with M6 nut runner.
2. Remove the front fixings screws of both shelf runners with M6 nut runner.
3. Pull the shelf runners forwards away from the rear screws.
4. Remove the 4 off M5 dome nut securing the Element cover plate.
5. Lift the Element cover plate out taking care to not damage the temperature sensor pocket.

PROCEDURE FOR REPLACING HEATER ELEMENT

Please Note
DO NOT attempt to carry out the following procedure unless you have the following part and tools.

Parts required for replacing heater element.

Item	Description	Part Number	Quantity
1	Heater Element	208 volt 40C0949 / 240 volt 40C0948	1
2	Mesh Washer	31Z5044	3

Tools required for replacing heater element.

M5 nut runner

1. Disconnect or isolate oven from mains supply.
2. Remove outer covers.
3. Remove shelf runners and element cover plate (See page 37).
4. Disconnect wires from heater element terminals at rear of oven.
5. Remove M5 screw securing heater element.
6. Remove heater element.
7. Refit new heater element with new mesh washers fitted over each terminal and 3 off M5 Flat washer over the M5 screw (**this is very important to prevent microwave leakage**).
8. Tighten M5 screw and check that the heater element is not touching the cavity or protruding to much that it will not touch the element cover plate.
9. Reconnect wires to heater element terminals at rear of oven.
10. Replace element cover plate and shelf runners.
11. **Perform Microwave Leakage procedure (see page 22-23) checking carefully around the heater element terminals at rear of oven.**
12. Replace outer covers and fully test oven.

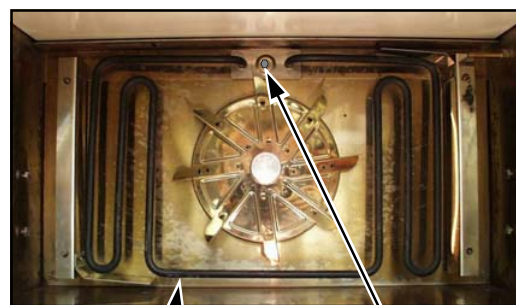

Heater Element

M5 x 25mm Hex head S/S screw Pt. No. 101825

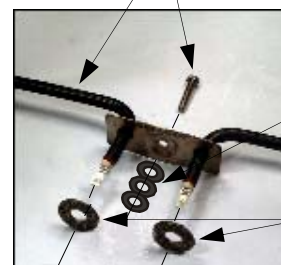

3x M5 Flat Washers

Mesh Washers

PROCEDURE FOR REPLACING HOT AIR MOTOR ASSEMBLY

Please Note
DO NOT attempt to carry out the following procedure unless you have the following part and tools.

Parts required for replacing hot air motor assembly.

Item	Description	Part Number	Quantity
1	Hot Air Motor Assembly	11C0312	1

Tools required for replacing hot air motor assembly.

M5 nut runner

1. Disconnect or isolate Oven from mains supply.
2. Remove outer covers.
3. Remove shelf runners and element cover plate (See page 37).
4. Remove fan blade securing nut and remove fan blade.
5. Disconnect motor connection at terminal block.
(Note: which wire colour goes to which terminal).
6. Disconnect Motor Earth tag then undo all securing nuts from the motor mounting plate and remove the fan motor assembly.
7. Check the position and condition of the hot air motor damper/seal (this a important microwave leakage seal) in the motor shaft screen.
(See page 17).
8. Fit new hot air motor assembly, and fit all securing washers and nuts, ensure it is aligned centrally into the hole in the cavity, and tighten all securing nuts. Make sure the ground wire is connected.
9. Reconnect motor connection at terminal block.
(Note: correct position of each wire colour).
10. Refit fan blade and fan blade securing nut, and **ensure that the fan/motor rotates free by hand.**
11. Refit shelf runners and element cover plate.

12. Perform Microwave Leakage procedure (see pages 22-23), checking carefully around the hot air motor assembly at rear of oven.

13. Replace outer covers and fully test oven.

Fan blade securing nut

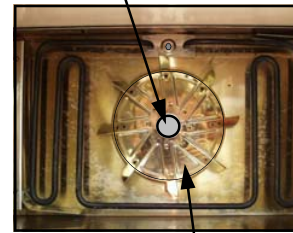

Fan blade

PROCEDURE FOR REPLACING MAGNETRON ASSEMBLY (1)

Parts required for replacing magnetron

Please Note

DO NOT attempt to carry out the following procedure unless you have the following tools and parts.

Item	Description	Part Number	Quantity
1	Magnetron	30Z1171	1

Tools required for replacing magnetron

Philips screw driver

M5 nut runner

WARNING

Before proceeding with this procedure ensure that the oven is disconnected from the power supply, And the high voltage capacitors are discharged
See Safety Code (Page 4)

1. Remove the top and side casing from the oven.
2. Remove the air duct cover plate.
(See figure 1 page 41)
3. Disconnect the 2 wires and earth wire from the over temperature stat and the 3 wires from the magnetron connection block.
(See figure 2 page 41)
4. Remove the 4 nuts from the magnetron fixing.
(See figure 3 page 41)
5. Remove the magnetron.
(See figure 4 page 41)
6. Remove the 2 screws from the over temperature stat on the magnetron and remove.
(See figure 4 page 41)
7. Visually inspect the new magnetron making sure that the wire mesh gasket seal is in place and undamaged. Check the outer casing for any damage such as dents.
(See figure 5 page 41)
8. Attach the oven temperature stat to the new magnetron.
(See figure 5 page 41)
9. Visually inspect the magnetron mount in the wave guide making sure that it is undamaged and that there is no debris that may obstruct the new magnetron when fitted.
(See figure 5 page 41)
10. Place the new magnetron in position making sure it is in the correct orientation.
11. Replace the 4 fixing nuts making sure that they are tightened equally.
12. Reconnect the wiring to the over temperature stat.
13. Reconnect the wiring to the magnetron.
14. Replace the air duct cover.

PROCEDURE FOR REPLACING MAGNETRON ASSEMBLY (2)

Figure 1 - 6

Figure 1



Screw

Figure 2



Temperature Stat.

Magnetron connection block

Figure 3

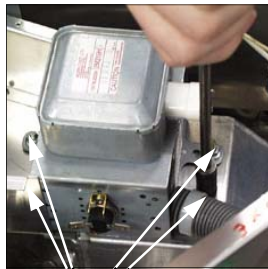

4 x Magnetron screw fixings

Figure 4

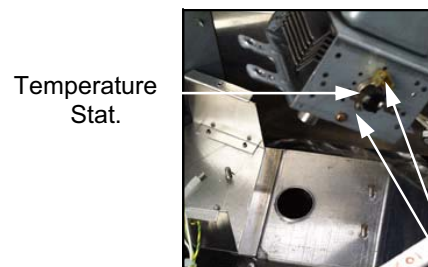

Temperature Stat.

Screws

Figure 5

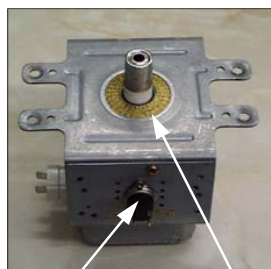

Temperature Stat.

Wire mesh

Figure 6

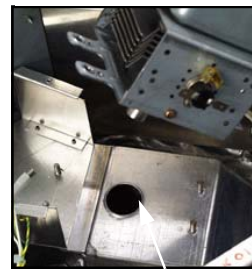

Magnetron mount

Please note.

After completing this procedure do a microwave leakage test.
See page 22-23.

PROCEDURE FOR TESTING MEMBRANE PANEL CIRCUIT

You will need:

A Digital Multi-meter (D.M.M.)

1. The oven isolate from the electrical supply.
2. Remove the Logic Assembly from the Control Panel Housing.
3. Unplug the membrane "tail" from the Logic PCB Assembly.
4. Using a D.M.M., check for continuity between the correct terminals when the pads are pressed.
5. When the panel has been tested, re-assemble and re-test the control circuit.

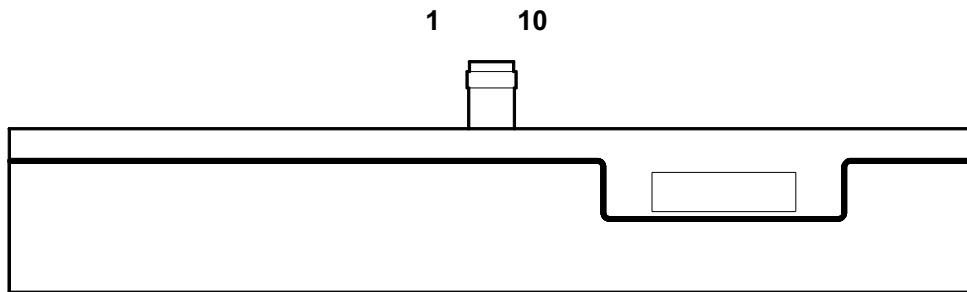

Mealstream 501 US

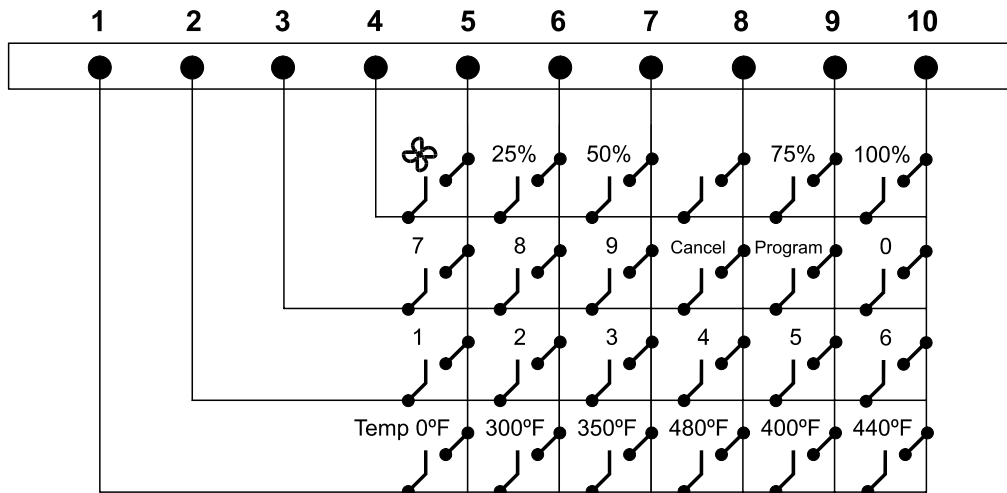

PROCEDURE FOR TESTING MEMBRANE PANEL CIRCUIT (2)

Mealstream 501 US Tim Hortons & Unbranded Variant

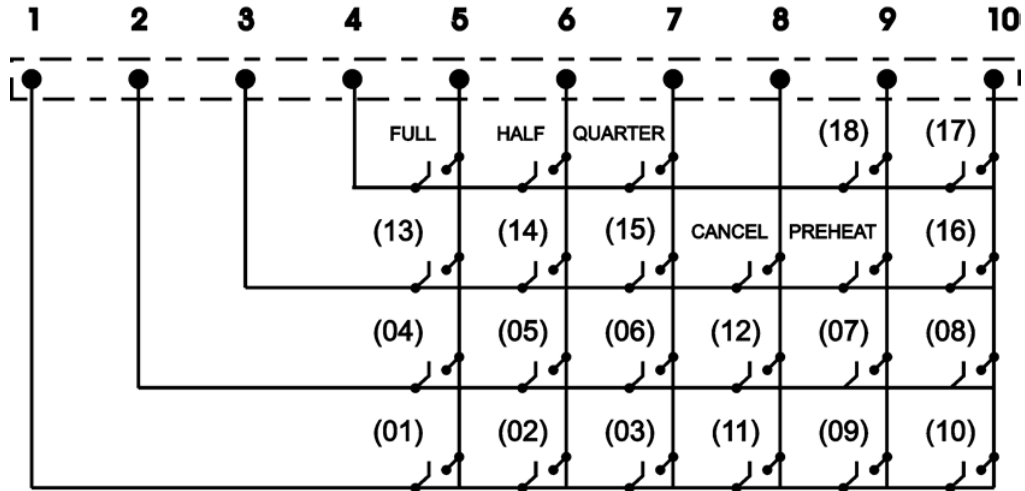

Note: PINS 1-4 Lower Layer & Pins 5-10 upper layer

Mealstream 501 US Tim Hortons French (Canada)

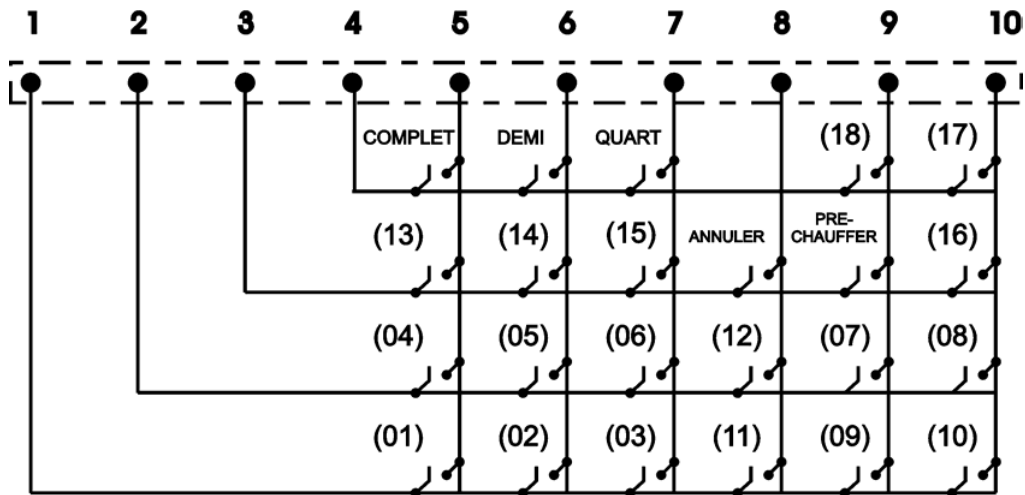





Note: PINS 1-4 Lower Layer & Pins 5-10 upper layer

ERROR CODES AND DIAGNOSTICS

The Mealstream will identify some of the most common problems by flashing an error message code in the time display window.

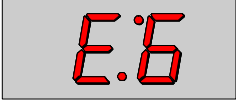
These are the error messages, and suggestions for repairing them.

	<ol style="list-style-type: none"> 1 2 3 	<p>Door not fully shut.</p> <p>Possible electrical fault</p> <p>Magnetron overheating.</p>	<p>Close door fully.</p> <p>Door switch inoperative.</p> <p>Check air filters. Check location, air inlet temperature and air filters.</p>
	<ol style="list-style-type: none"> 1 2 3 4 	<p>No time has been set.</p> <p>Invalid time has been set.</p> <p>Invalid program has been set.</p> <p>TIM HORTONS No cook program assigned to selected pad</p>	<p>Set a time.</p> <p>Set a valid time.</p> <p>Use call-back to check program.</p> <p>Ensure correct Menukey is installed (switch oven off then on to show key No.)</p>
	<ol style="list-style-type: none"> 1 2 	<p>Oven not heating up.</p> <p>Possible Heater fault.</p>	<p>Check heater fuse.</p> <p>Confirm operation of heater circuit.</p>
	<ol style="list-style-type: none"> 1 	<p>Oven is not at correct temperature to start program.</p>	<p>Remove food. Allow oven to reach correct temperature.</p>
		<p>If the key is removed before the download is complete or the process is interrupted the display shows EPS then FAIL then REDO</p>	<p>Switch oven off and begin the MenuKey download again. See Appendix 2.</p>

APPENDIX 1

Tim Hortons variants: Power Test and Microwave Leakage Test (Pages 22-24)

Engineering Mode programs

In order to carry out the Power Test and Microwave Leakage Test on Tim Hortons variant Ovens, the Icon Pad programs on the control panel need to be switched to Engineering Program Mode.

Engineering Mode does not affect the current Menukey program settings for the Icon pads and the current Menukey programs are automatically restored when the oven is next switched on.

To switch to Engineering Mode Programs:

- 1 With the oven switched off hold down the CANCEL (ANNULER) Pad and switch the oven ON, the display shows the current Menukey Code, continue to hold the CANCEL (ANNULER) Pad for approximately 10 seconds until the display shows **EE 00:00** indicating the oven is now in engineering mode
- 2 Programs will be set as follows:

Program Number		Time	Temp	Power
Pad 01		1 minute 3 secs	Off	100%
Pad 02		3 minutes	Off	100%
Pad 03		59 minutes 59secs	480 °F	None
Pad 04	Stage 1	30 minutes	480 °F	100%
	Stage 2	29 minutes 59 secs	480 °F	50%

All other programs will be blank

- 3 Follow the Leakage Check Procedure as detailed on pages 22-23, using Program 01 (Cake) to give the required 1 minute 3 seconds at 100% Microwave Power setting.
- 4 Follow the Power test procedure as detailed on Page 24 using Program Pad 01 (Cake) to give the required 1 minute 3 seconds at 100% Microwave Power setting.
- 5 On completion the current Menukey programs are automatically restored when the oven is next switched on.

APPENDIX 2: MenuKey™ DOWNLOAD PROCEDURE

The MenuKey™ System automatically changes all the cooking programs on the numbered icon pads with the turn of a key.



To change the menus on the oven:

- 1 Ensure the power switch is **off**.
- 2 Lift the MenuKey™ cover in the top panel of the oven and put the key in the keyhole. Turn the key clockwise to the stop (¼ turn).
Do not remove the key at this stage.

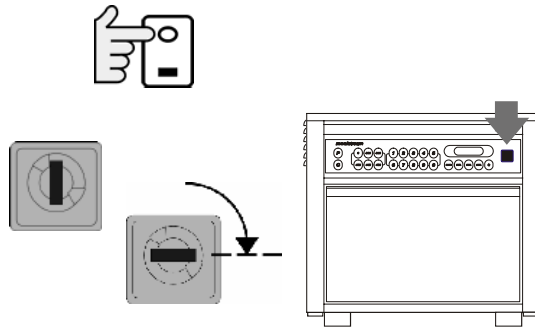

- 3 Switch the power switch **on**. The oven will now go through the program download sequence by displaying the following:

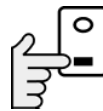

The Key Code

example: Key 01



The number of programs and each program number on the key.

example: 38 programs



When the display shows 0:00, the cavity lights up and the fans start.



Remove the key and close the cover and the oven is ready to use with the new programs.

To confirm the download is successful

Switch off the oven.

Switch on and the display briefly will show the following:

1. The new key code
2. 0:00 (oven ready to use)

EPS-FAIL-REDO

If the key is removed before the download is complete or the process is interrupted the display shows EPS then FAIL then REDO

Switch oven off and begin the MenuKey download again.

APPENDIX 3: TEMPERATURE SENSOR RESISTANCE DATA

Temperature Sensor Resistance

Temp °F	Temp °C	Min. Rate kΩ	Standard Rate kΩ	Max. Rate kΩ
212	100	11.490	13.060	14.810
302	150	2.803	3.161	3.434
350	177		1.741	
392	200	0.950	1.000	1.050
482	250	0.3572	0.3865	0.4171

$R(200)^{\circ}\text{C} = 1 \text{ k}\Omega \pm 5\%$

Note:

These resistances will only be apparent in a stable cavity temperature as the sensor has a slow response time.

APPENDIX 4: Cleaning procedure Mealstream 501

For the oven to operate at peak efficiency, the cavity, door and the air filters must be kept clean.

A daily cleaning routine will ensure that you comply with the required hygiene standards and will help to maintain and prolong the efficiency of your oven.

Follow the SAFETY INSTRUCTIONS at the beginning of this manual.

- **ALWAYS switch off at the electrical supply and allow oven to cool for at least 20 minutes before cleaning.**
- **As required, wipe out spillage's with disposable paper wipes**
- **NEVER use steel wool, knives or harsh abrasives on any part of the oven**

Faults arising from neglect or misuse including use without clean filters in place are not covered by the guarantee. Service visits as a result of such faults will be chargeable.

As with all electrical appliances, it is wise to have the electrical connections inspected periodically.

Cleaning the Air Filters (Part No. 40C0868)

- 1 Remove the air filters from each side of the oven by sliding the filter out from the front.
- 2 Wash in clean, warm soapy water, rinse and pat dry. Slide back into position through slots.

Cleaning the oven cavity and door

- 1 Remove food particles from the gap between the rear baffle plate and the floor of the oven with a clean, dry brush. (Location A)
Remove food particles from between the inside edge of the door and the front of the oven floor using a clean, dry brush. (Location B)
- 2 Apply non-caustic oven cleaner to interior surfaces except door seals. Leave for the recommended time. Wash off using a clean cloth and plenty of clean, warm water. Dry using a fresh, clean cloth.
- 3 Wipe hinges with a clean, damp cloth.
DO NOT apply lubricating oil.
- 4 Wipe door seals carefully with a clean damp cloth. Examine for signs of wear or damage.

Cleaning the control panel and exterior surfaces

Wipe down regularly with a damp cloth.

Hints and Tips for stubborn stains in the oven cavity

- 1 Switch on oven with microwave power only (without heat).
- 2 Place a container of water (3 pints/1.5 litres) into the centre of the oven cavity.
- 3 Set microwave power to 100%.
- 4 Set timer to 30 minutes and press start button at end of steam cycle wipe out cavity with a clean cloth.

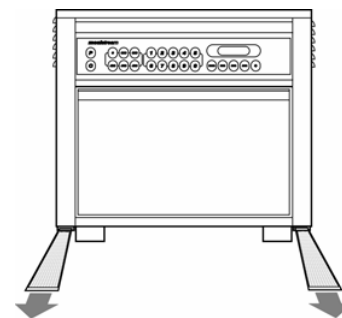

DO NOT USE THE OVEN WITHOUT CLEAN AIR FILTERS IN POSITION

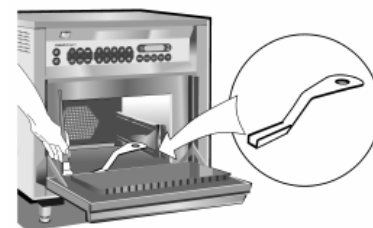
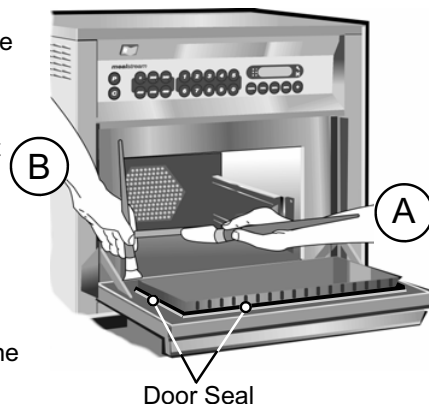

If the door seals are damaged, the oven must be repaired by an approved Servicer.

APPENDIX 5: Hot Air Motor Upgrade

Hot Air Motor Upgrade to High Speed Type: Models before February 2005



Cavity showing Impeller with threaded securing nut
(Element cover plate removed)

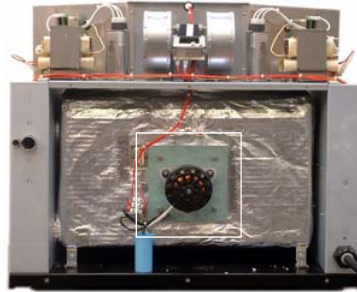

Rear view of oven showing Hot Air Motor

If the oven has an impeller secured with a Threaded Nut it should be upgraded with Hot Air Motor Kit Part No. [10C0192](#).

The motor now has a plain shaft and the new impeller design is secured with a small hex set screw.

The RF trap/motor shaft screen has a series of concentric grooves and is replaced with a plain cylinder type.

See element cover plate and shelf runner/ tray support removal procedure Page 37

Pre-February 2005
Impeller with
Threaded nut fixing

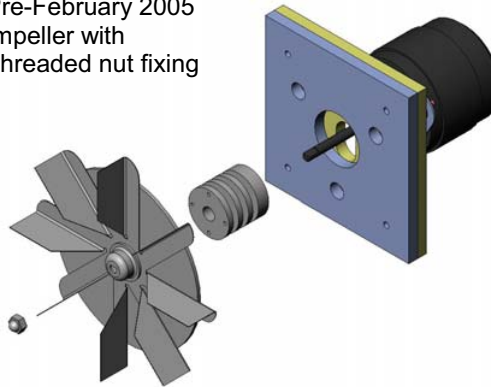

Current Production Models:
From Model Serial No. 142160205
These ovens are fitted with the new high speed Hot Air Motor.
Note: the RF trap/screen fitted to these models is a larger diameter and not compatible with earlier models.

High speed motor
Impeller with set
screw fixing

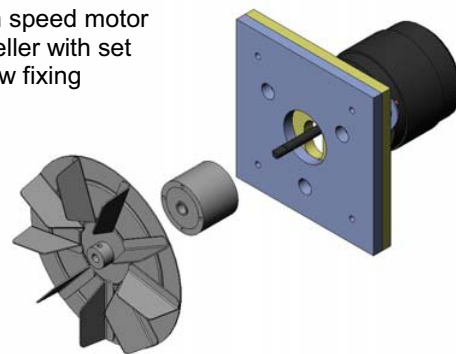

APPENDIX 6: Recommended spares list

**Recommended spares list (to support 1– 3 ovens)
Available as complete kit on part number 10C0244 (208V 60Hz)**

Item No.	Part Number	Description	Quantity per kit
1	11M0417	HT DIODE PCB ASSY	2
2	11C0292	CTM3 DOOR SEAL SET	1
3	11C0319	STIRRER GLASS ASSY	1
4	11C0324	STIRRER MOTOR ASSY WIDE DIST	1
5	11C0377	MEALSTREAM 501 LOGIC PCB ASSY	1
6	11C0402	CTM5 RELAY PCB ASSEMBLY 208V	1
7	30Z0217	FUSE 1in 10A HRC	10
8	30Z0231	FUSEHOLDER 1in (13A)	3
9	30Z0283	470R 50W 5% AC	1
10	30Z0503	SWITCH ON/OFF ROCKER DPST	1
11	30Z0957	FUSE 1x1/4in 1A HBC (MAINS)	3
12	30Z0997	FILTER 16A	2
13	30Z1145	DOUBLE BLOWER FAN 208V 60HZ	1
14	30Z1177	20 AMP LITTELFUSE FLM020	10
15	30z1178	30A FUSE HOLDER	2
16	30Z1230	60HZ TRANS MULTI 208 220 240	1
17	790052	RED SILICON SEAL LH/RH	3 metres
18	2571016	THERMAL CUT OUT 125C	2
19	10C0171	DOOR SPACER KIT	1
20	30Z1024	OVERHEAT SAFETY STAT	1
21	40C1141	DOOR SPRING(LARGE) MSTREAM 501	2
22	50E123	THERMISTOR	1
23	40C0949	HEATER ELEMENT 3.0 KW 208V	1
24	30Z1171	MAGNETRON PANASONIC 2M244	2
25	10C0192	M/EALSTREAM 501 HOT AIR MOTOR	1
26	11C0412	MEMBRANE ON SUBS TH 1/4 E ASSY	1
27	11C0481	MICROSWITCH REPLACE KIT EC501	2
28	10C0172	CAPACITOR KIT: 30Z1251 0.88uF 2500V and clips	2
29	40C1113	ROOF CORNER CAP	4
30	11C0482	SCREW FIXING KIT EC501/2/3	1

APPENDIX 7: Door stop & Adjustable microswitch bracket

All Oven models from May 2005

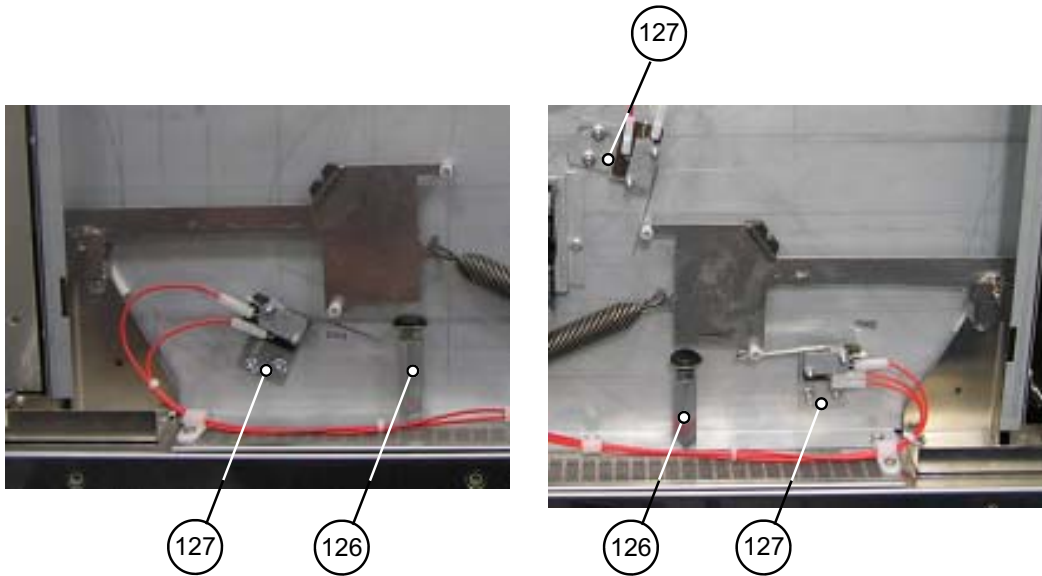

No	Description	208V	240V
126	Door arm stop assembly	11C0480	11C0480
127	Adj. Microswitch support bracket	40C1233	40C1233

APPENDIX 8: Door arm guide

Door arm guide upgrade

Ovens manufactured before Serial No. 144460505, May 2005

Parts required:

1. Pt. No. [40C1241](#) Door arm guide

Brief description:

It has been identified that in transit and under some operating conditions the door arm can lift and become jammed behind the lever on Microswitch SW1. The subsequent door arm operation then permanently damages the microswitch arm and the oven becomes unusable.

When fitted, the door arm guide protects the microswitch lever and prevents this condition from occurring.

This part is fitted as standard on all models from Serial No. 144460505, May 2005

When to perform this upgrade:

On inspection of the oven if the microswitch arm has been damaged by the door arm.

(Ovens manufactured before Serial No. 144460505, May 2005)

Switch oven off and isolate from mains supply prior to carrying out this modification.

1. Remove the top cover and Left hand side panel
2. Undo the 2 self tapping screws holding fuse bracket (F5 & F1).
Slide the Door arm guide behind the fuse bracket assembly and align the holes.
Secure in place with the 2 self tapping screws.
3. Replace covers and screws

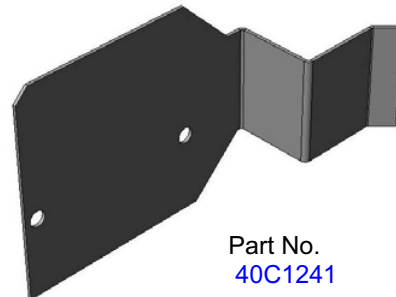

Part No.
[40C1241](#)

LH side only

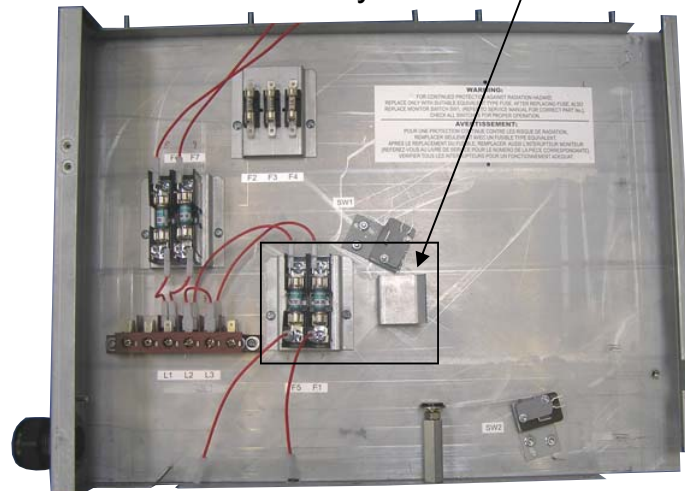

Door arm & spring not shown for clarity

MANUAL CORRECTIONS AND MODIFICATIONS

Whilst every effort has been made to ensure that the information contained in this manual is accurate and complete, if you believe that an error has been made, or if you have any suggestions for how the manual could be improved, please fill in and return this form. A review of any forms returned will be made on a regular basis, and the manual will be updated if required.

Name	
Address	
Page number on which error occurs (if applicable) - Mealstream Garland	
Description of error	
Suggestion for improvement to manual	
Please return this form to: Garland Commercial Industries 1177 Kamato road Mississauga Ontario L4W 1X4 CANADA Attn : Service Department Or Fax it on 800-361-7745	

 **GARLAND**[®]