



PRODUCT MANUAL INSTALLATION, OPERATION, PARTS AND SERVICE

**ELECTRIC DUAL SIDE
CLAMSHELL BROILER
MODEL: CXBE12**



**FOR YOUR SAFETY:
DO NOT STORE OR USE GASOLINE OR
OTHER FLAMMABLE VAPORS OR LIQUIDS
IN THE VICINITY OF THIS OR ANY OTHER
APPLIANCE**

**WARNING:
IMPROPER INSTALLATION, ADJUSTMENT,
ALTERATION, SERVICE OR MAINTENANCE
CAN CAUSE PROPERTY DAMAGE, INJURY,
OR DEATH. READ THE INSTALLATION,
OPERATING AND MAINTENANCE
INSTRUCTIONS THOROUGHLY
BEFORE INSTALLING OR
SERVICING THIS EQUIPMENT**

PLEASE READ ALL SECTIONS OF THIS MANUAL AND RETAIN FOR FUTURE REFERENCE.

THIS PRODUCT HAS BEEN CERTIFIED AS COMMERCIAL COOKING EQUIPMENT AND MUST BE INSTALLED BY PROFESSIONAL PERSONNEL AS SPECIFIED.

INSTALLATION AND ELECTRICAL CONNECTION MUST COMPLY WITH CURRENT CODES:

IN CANADA - THE CANADIAN ELECTRICAL CODE PART 1 AND / OR LOCAL CODES.

IN USA – THE NATIONAL ELECTRICAL CODE ANSI / NFPA – CURRENT EDITION.

ENSURE ELECTRICAL SUPPLY CONFORMS WITH ELECTRICAL CHARACTERISTICS SHOWN ON THE RATING PLATE.

For Your Safety:

Post in a prominent location, instructions to be followed in the event the user smells gas. This information shall be obtained by consulting your local gas supplier

THIS EQUIPMENT MUST BE INSTALLED AND COMMISSIONED BY A PROFESSIONAL, FACTORY-TRAINED TECHNICIAN.

THIS EQUIPMENT MUST BE OPERATED UNDER AN APPROVED HOOD SYSTEM ONLY.

MANUFACTURED EXCLUSIVELY FOR **CHICK-FIL-A** BY:
GARLAND COMMERCIAL RANGES
<http://www.garland-group.com/>

IMPORTANT INFORMATION

WARNING:

THIS PRODUCT CONTAINS CHEMICALS KNOWN TO THE STATE OF CALIFORNIA TO CAUSE CANCER AND/OR BIRTH DEFECTS OR OTHER REPRODUCTIVE HARM. INSTALLATION AND SERVICING OF THIS PRODUCT COULD EXPOSE YOU TO AIRBORNE PARTICLES OF GLASS WOOL/CERAMIC FIBERS. INHALATION OF AIRBORNE PARTICLES OF GLASS WOOL/CERAMIC FIBERS IS KNOWN TO THE STATE OF CALIFORNIA TO CAUSE CANCER. OPERATION OF THIS PRODUCT COULD EXPOSE YOU TO CARBON MONOXIDE IF NOT ADJUSTED PROPERLY. INHALATION OF CARBON MONOXIDE IS KNOWN TO THE STATE OF CALIFORNIA TO CAUSE BIRTH DEFECTS OR OTHER REPRODUCTIVE HARM.

KEEP APPLIANCE AREA FREE AND CLEAR OF COMBUSTIBLES.



**Please feel free to contact
Us at 1-855-586-1542**

CONTENTS

WARRANTY	4	PLATEN ERRORS	31
SHIPPING DAMAGE CLAIM PROCEDURE	4	READING THE LED'S FROM SIB - PLATEN HOMING.	32
SAFETY	5	READING THE LED'S FROM SSRB	33
DIMENSION SPECIFICATION	6	CLAMSHELL BROILER ACCESSORIES	34
Dimensions: Broiler	6	USE AND CARE	35
CLAMSHELL BROILER SPECIFICATION	7	Operation	35
Shipping Dimensions and Weight	7	Shutdown	35
Electrical Input Specifications	7	Warnings	35
INTRODUCTION	8	Service Maintenance	36
Packing	8	Service and Parts	36
Unpacking	8	CLEANING AND MAINTENANCE	37
Temporary Storage	8	Daily Cleaning	37
Safety	8	Weekly Cleaning	39
INSTALLATION	9	CHICKEN PRODUCT PLACEMENT	42
General	9	CHICKEN / NUGGETS PRODUCT PLACEMENT	43
Rating Plate	9	BACON / SAUSAGE PRODUCT PLACEMENT	44
Positioning and Setup	9	DESCRIPTION OF CLAMSHELL BROILER CONTROL	46
Appliances Equipped with Casters	9	easyToUCH™ OVERVIEW	47
STEPS TO REMOVE CLAMSHELL BROILER FROM WOOD		Clamshell Broiler Operating Modes:	47
CRATE	10	Cook Cycle Changes:	47
Air Supply and Ventilation	11	OTHER easyToUCH™ SCREENS	47
ELECTRICAL CONNECTION	12	Temperatures:	48
Electrical Grounding Instructions	12	Warnings and Alerts:	48
Important Electrical Precautions	12	Grates Open:	48
CLAMSHELL BROILER START UP	13	Shutdown:	48
Remove stainless steel plastic film cover	13	Cleaning Reminders:	48
Temperature Verification	13	START UP COOKING:	49
LOWER THERMOCOUPLE LOCATIONS	14	COOKING A RECIPE:	50
UPPER THERMOCOUPLE LOCATIONS	14	CHANGES TO A RECIPE COOK CYCLE:	51
Startup Form Procedure	15	SLEEP MODE:	51
THERMOCOUPLE LOCATIONS DIAGRAM	15	SETTINGS MODE:	52
START UP CHECKLIST SAMPLE	16	INSTRUCTION FOR SOFTWARE UPDATE	54
FRONT CASTERS ADJUSTMENT	17	LOGIC MENU TREE	58
LATCH SYSTEM INTERNAL OPERATION - A, UNLATCHING	18	DIAGNOSTICS EVENTS LIST	59
LOWER GRATE ADJUSTMENT PROCEDURE	20	TROUBLESHOOTING STEPS	63
GAP CALIBRATION & UPPER PLATEN ASSEMBLY		Cooking Issues	63
LEVELLING	22	Temperature Issues	65
EXHAUST MOTOR FUSE REPLACEMENT	25	UI issues	67
EXHAUST MOTOR ASSEMBLY REPLACEMENT	26	Clamshell Issues	68
LOWER GRATE REPLACEMENT PROCEDURE	27	BROILER ACCESSORIES, PART LIST	70
LOWER INFRARED ELEMENT REPLACEMENT		BROILER EXTERIOR, PART LIST	72
PROCEDURE	28	BROILER PLATEN EXHAUST ASSEMBLY, PART LIST	74
UPPER GRATE ELEMENT REPLACEMENT PROCEDURE ..	29	BROILER ACTUATOR ASSEMBLY, PART LIST	76
READING THE LED'S FROM SOFTWARE INTERFACE		WIRE HARNESSSES, PART LIST	78
BOARD (SIB)	30	WIRING DIAGRAM	80
READING THE LED'S FROM SIB - DIAGNOSE			

WARRANTY

This warranty covers defects in material and workmanship under normal use providing that:

1. the equipment has not been accidentally or intentionally damaged, altered or misused;
2. the equipment is properly installed, adjusted, operated and maintained in accordance with national and local codes and in accordance with the installation instructions provided with this product;
3. the warranty serial number affixed to the appliance by Garland has not been defaced, obliterated or removed;
4. an acceptable report for any claim under this warranty is supplied to Garland;

The equipment warranty coverage remains in force for a period of one (1) year (parts and labor) from the date the product is first put into operation.

The Garland Group agrees to repair or replace, at it's option, any part that proves to be defective in material or workmanship at no charge for the part or normal labor.

We assume no responsibility for installation, adjustments, diagnosis, or normal maintenance such as: lubrication of springs or valves.

We assume no responsibility for travel costs beyond two (2) hours and 100 miles/150Kms round trip, travel other than overland, and overtime costs of repair.

We exclude broken glass, paint and porcelain finish, surface rust, gasket material, ceramic material, light bulbs and fuses from normal coverage.

We exclude damage or dysfunction caused by fire, flood, and like "Acts of God" that are beyond the control of The Garland Group.

We exclude failures caused by erratic voltage or gas supplies.

The Garland Group will only cover the cost of the parts replacement and/or service.

This warranty is limited and is in lieu of all other warranties, expressed or implied. The Garland Group, our employees, or our agents shall not be held liable for any claims of personal injury or consequential damage or loss.

This warranty gives you specific legal rights, and you may have other rights which vary from state to state.

Do not use abrasive materials on the chrome surface, such abrasive scouring pads. Using abrasive materials will void your warranty

Do not use this unit outdoors, operating unit outdoors will void your warranty.

Do not remove any permanently affixed labels, warnings or data plates from the appliance as this may invalidate the Garland warranty.

Garland recommends a Preventative Maintenance Program which is essential to extends the life of the equipment.

SHIPPING DAMAGE CLAIM PROCEDURE

Please note that the Garland equipment was carefully inspected and packed by skilled personnel before leaving the factory. The transportation company assumes full responsibility for safe delivery upon acceptance of the equipment. What to do if the equipment arrives damaged:

1. File a claim immediately regardless of the extent of damage.
2. Be sure to note, "visible loss or damage," on the freight bill or express receipt and have the person making the delivery sign it.
3. Concealed loss or damage: if damage is unnoticed until the equipment is unpacked, notify the freight company immediately, (within 15 days), and file a concealed damage claim.

SAFETY

- **DISCONNECT ELECTRICAL SUPPLIES BEFORE OPENING PANELS FOR SERVICING.**
- **KEEP THE APPLIANCE AREA FREE AND CLEAR FROM COMBUSTIBLES.**
- **DO NOT OBSTRUCT THE FLOW OF COMBUSTION AND VENTILATION AIR (if applicable).**

This appliance is for professional use and shall be used only by qualified personnel.

Warning: Accessible parts may become hot during use. Young children should be kept away. This appliance is not intended for use by persons (including children) with reduced physical, sensory or mental capabilities, or lack of experience and knowledge, unless they have been given supervision or instruction concerning use of the appliance by a person responsible for their safety."

CAUTION: THIS EQUIPMENT MUST ONLY BE OPERATED UNDER AN APPROVED HOOD SYSTEM IN ACCORDANCE WITH LOCAL REGULATIONS IN FORCE. THIS UNIT IS INTENDED FOR INDOOR USE ONLY.

THIS PRODUCT IS NOT AUTHORIZED FOR HOME OR RESIDENTIAL USE. GARLAND WILL NOT PROVIDE SERVICE, WARRANTY, MAINTENANCE, OR SUPPORT OF ANY KIND OTHER THAN IN COMMERCIAL APPLICATIONS.

Do not operate the broiler unless it has been commissioned (Start-Up) by a Factory Authorized Service Center.

Do not operate the broiler without reading this operation manual.

Do not operate the broiler unless it has been properly installed and grounded.

Do not operate the broiler unless all service and access panels are in place and fastened properly.

Do not use an extension cord to connect this appliance to a power supply.

Do not use this appliance if the power cord is damaged. **Do not** attempt to repair a damaged power cord.

Caution! Use care when moving this unit. This unit cannot be dropped as it will impact the performance of the electronics.

Take care not to expose the power cord to heat (i.e. near the flue, etc.) and be careful not to damage the cord by pinching or rubbing on sharp edges.

Do not clean the broiler with a power washer. This appliance is not approved for power washing.

The appliance generates significant amounts of heat and the operator should take care when touching accessible surfaces that are likely to get hot. Surfaces close to the cooking surface including side panels may get hot enough to burn skin.

Do not attempt to service this appliance unless you are a qualified service technician.

This appliance is intended for **commercial use only** and should only be operated by fully trained and qualified personnel.

The electrical power supply must be disconnected prior to cleaning or any maintenance or service work being done on the appliance.

Do not sit or stand on the appliance under any circumstances. Serious injury and damage to the appliance and/or property could result.

Warning: The broiler grates will get extremely hot. Even close up it may not appear to be hot but can cause burn if touched.

DIMENSION SPECIFICATION

Dimensions: Broiler

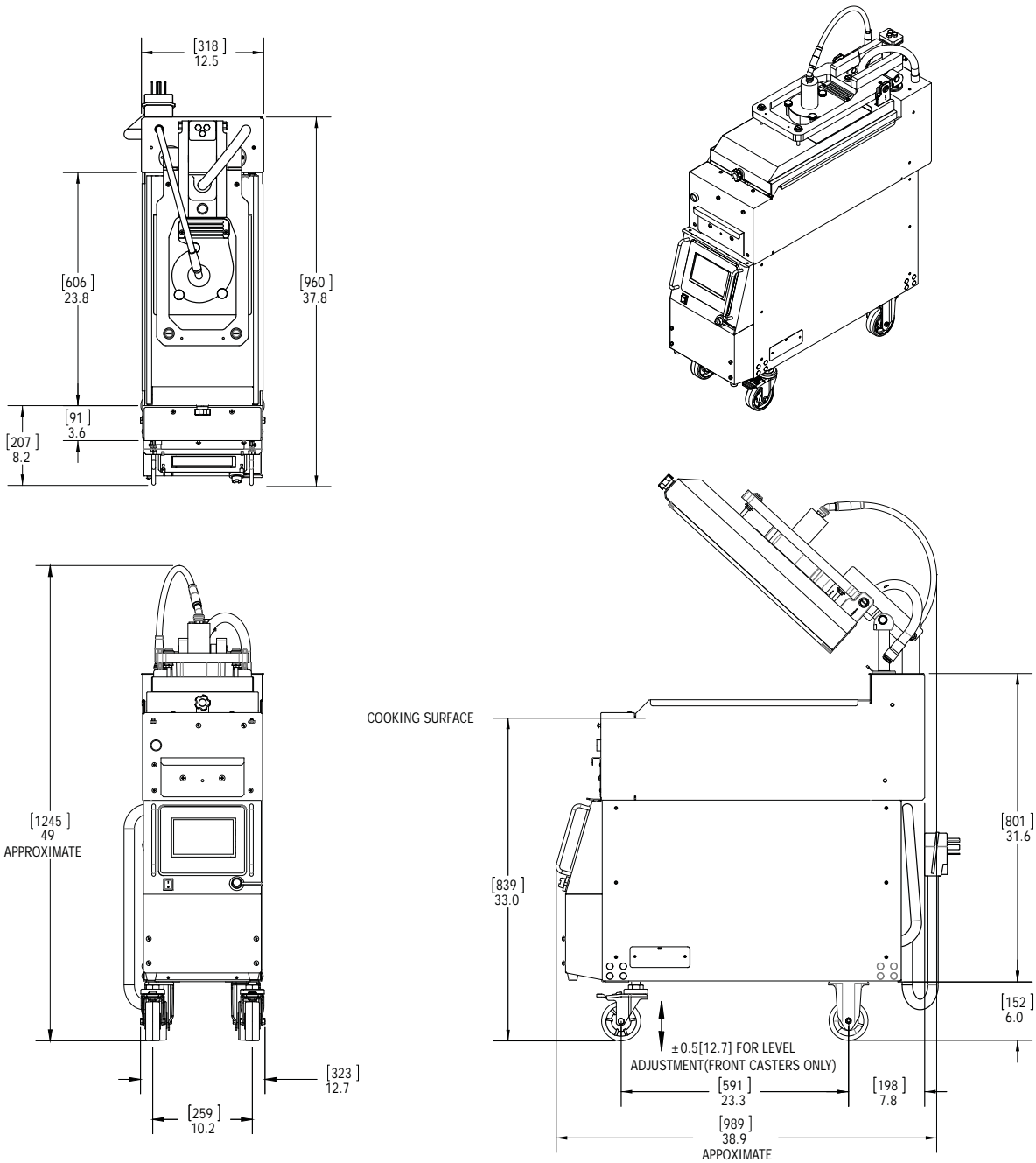

MODEL	HEIGHT*		WIDTH		DEPTH	
	inches	mm	inches	mm	inches	mm
CXBE12	49	1245	12.5	318	37.8	960

* Height shown to top of the flexible conduit and therefore indicated as approximate.

CLAMSHELL BROILER SPECIFICATION

Shipping Dimensions and Weight

MODEL	SHIPPING DIMENSIONS inches (mm)			
	Length	Width	Height	
CXBE12	43 1/2" (1105mm)	27 3/8" (695mm)	49 5/8" (1260mm)	Shipping Weight 545 lbs/247 Kg
	UNCRATED DIMENSIONS inches (mm)			
	Length	Width	Height	Unit Weight 480 lbs/218 Kg
	37 13/16" (960mm)	12 1/2" (960mm)	49" (1245mm)	

Electrical Input Specifications

MODEL	ELECTRICAL REQUIREMENTS**					
	Voltage (V)	Total kW	Frequency (Hz)	Unbalance 3 phase Amps per line		
				L1	L2	L3
CXBE12	208 / 3phase	16.05	60	43.4	43.4	47.0

A 5-foot (1.5m) long power supply cord with an integral (NEMA 15-50) plug is provided with each model.

Note: Wiring diagram is supplied with each unit.

INTRODUCTION

GARLAND RECOMMENDS THAT INSTALLATION, MAINTENANCE AND REPAIRS BE DONE BY AN AUTHORIZED SERVICE AGENCY, OTHERWISE THE WARRANTY WILL BE DEEMED NULL AND VOID. FOR A LIST OF AUTHORIZED SERVICE AGENTS, REFER TO THE GARLAND WEB SITE AT <http://www.garland-group.com>.

This appliance should be given regular care and maintenance to operate at peak performance and maximum energy efficiency. It is recommended that the unit be inspected every 6 months by a certified service technician for proper operation and performance. Remember "regular maintenance ensures peak performance."

Every broiler is inspected and tested at the factory prior to shipment.

Packing

The product is shipped in a substantial crate with the broiler in vertical position. Casters are factory installed on the broiler. Garland places the unit/accessories in the crate in a neat and organized manner and in such a way as to eliminate damage from movement, rubbing etc.

Check crate for any visible damage sustained during transit.

It is recommended to remove crate when the clamshell broiler is inside the kitchen.

Unpacking



CAUTION

Heavy load
Use of lifting aids
and proper lifting
technique required

Carefully remove unit from crate and thoroughly inspect it for any visible or concealed damage. Report any damage immediately to your carrier to file the appropriate freight claims. For more information, see page 4. Push or pull broiler must be taken care to see that the broiler does not tip over.

Do not remove any permanently affixed labels, warnings or data plates from the appliance as this may invalidate the Garland warranty.

Temporary Storage

Garland provides adequate protection under normal conditions. The broiler may need additional protection if it is stored near salt water, a tropical area, or other unfavorable conditions. You must contact Garland immediately if these conditions occur.

Safety

It is essential that the instructions in this manual be strictly followed for the safe and economical operation of the equipment. Should it be known or suspected that a fault exists with the appliance, then it must not be used until the fault is rectified by a authorized or certified service person.

This appliance provides a sleep mode which ensures the unit avoids overheating when idle.

INSTALLATION

THIS PRODUCT IS NOT AUTHORIZED FOR HOME OR RESIDENTIAL USE. GARLAND WILL NOT PROVIDE SERVICE, WARRANTY, MAINTENANCE, OR SUPPORT OF ANY KIND OTHER THAN IN COMMERCIAL APPLICATIONS.

General

In the United States the installation must comply with the latest edition of the National Electrical Code ANSI/NFPA 70 – latest edition and/or local Codes to assure safe and efficient operation.

In Canada, the installation must comply with local codes and CSA B149.1 and handling Code –latest edition and the Canadian Electrical Code C22.1 – latest edition.

In other countries installation must be carried out by a factory authorized service representative according to the relevant regulations, codes of practice and the related requirements of the country of destination.

Adequate clearance must be provided for servicing and proper operation.

If you have any questions regarding the installation of this unit, contact the Garland Service Department at (855)-586-1542 or Garland Regional Service Managers.

Rating Plate

Two (2) rating plates will be installed on each unit, and they can be found:

- Inside the front panel under the electronic touch control.
- The lower edge of the right exterior body side near the front of the unit.

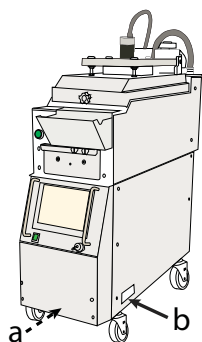

If service or replacement parts are needed, refer to the model number (including prefix & suffix letters/numbers) and serial number on the rating plate when in contact with the factory or authorized service agency. These numbers ensure proper unit identification, faster and more accurate service.

Positioning and Setup



CAUTION

Heavy load
Use of lifting aids
and proper lifting
technique required

The unit is very heavy (500 Lbs) so some form of mechanical assistance is recommended to lift and position the broiler.

The unit is designed to be placed on a smooth and level floor built to withstand the weight of the fully laden appliance. To comply with NSF Sanitation Standards the unit must stand on casters for ease of mobility during cleaning procedures.

Appliances Equipped with Casters

All broilers are shipped with casters installed in place, however some adjustment may be required to level the unit. The front casters are adjustable swivel casters with brakes. The rear casters are fixed. Garland recommends installing restraining chains/cables from the floor/wall to the rear of the unit. These restraints limit the mobility of the appliance.

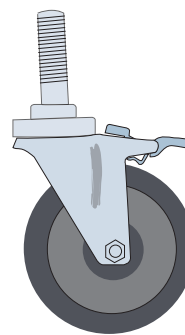

FRONT CASTER WITH BRAKE

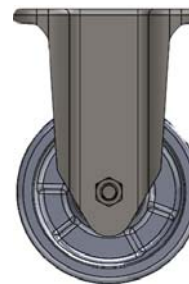

REAR CASTER WITHOUT BRAKE

STEPS TO REMOVE CLAMSHELL BROILER FROM WOOD CRATE



CAUTION

Heavy load
Use of lifting aids
and proper lifting
technique required

The unit is very heavy (500Lbs) so some form of mechanical assistance may be required to lift and position the broiler.

Personal Protective Equipment (PPE) required.

STOP! - FOLLOW THE INSTRUCTIONS BELOW TO SAFELY AND EASILY REMOVE UNIT FROM PACKAGING SKID

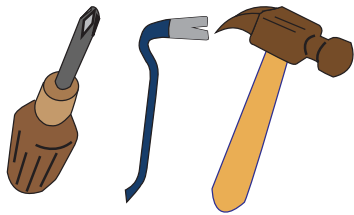

Tools required.

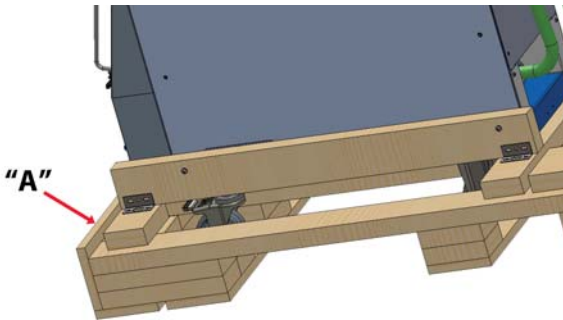

1. REMOVE AND DISCARD FRONT STOP BOARD (ITEM "A") NAILED TO FRONT OF SKID.

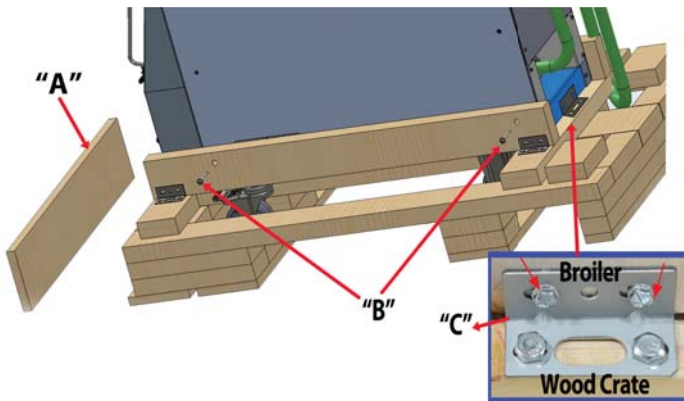

2. REMOVE AND DISCARD TWO (2) #10-24 X 2 1/2" LONG TRUSS HEAD PHILLIPS DRIVE MACHINE SCREWS AND FLAT WASHERS FROM THE LOWER SUPPORT BRACE ("ITEM B") ON EACH SIDE OF UNIT.
3. REMOVE AND DISCARD TWO (2) # 10-24X1/2" HEX HEAD SCREWS (BROILER SIDE) FROM THE BACK LOWER SUPPORT ANGLE ("ITEM C") ON BACK OF UNIT.

NOTE: ENSURE FRONT CASTER BRAKES ARE OFF.

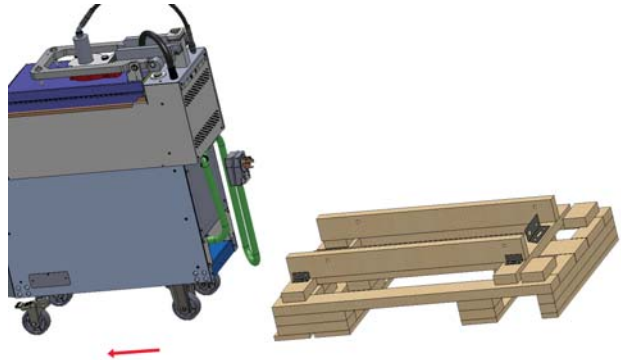

4. PUSH UNIT FORWARD OFF OF THE SKID. THE LOWER SIDE SUPPORT BRACES WILL SERVE AS GUIDES AND ENSURE THAT THE UNIT ROLLS STRAIGHT AS IT IS BEING MOVED.
5. REPLACE THE FASTENERS REMOVED FROM EACH SIDE OF THE UNIT IN STEP 2 WITH TWO (2) #10-24 X 1/2" LONG PAN HEAD PHILLIPS DRIVE MACHINE SCREWS INCLUDED WITH UNIT ACCESSORIES.

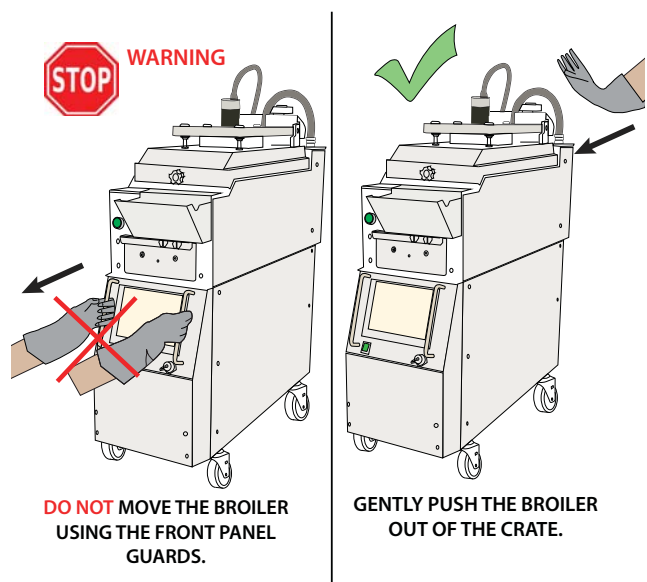

INSTALLATION, *continuation*

Air Supply and Ventilation

VENTILATION REQUIREMENTS MAY BE SUBJECT TO LOCAL BUILDING AND FIRE CODES. CONSULT LOCAL AUTHORITIES HAVING JURISDICTION.

This broiler appliance must be vented properly to operate correctly and safely. Due to the extremely high temperature a fire safety system should be installed. In addition, frequent cleaning of the vent hood and the appliance greatly reduces any fire risk.

For any commercial cooking appliance, means must be provided to exhaust combustion waste products, steam, etc. to the outside of the building. Proper ventilation is essential for optimum performance.

Air movement should be checked during installation. There must be adequate air intake into the building to compensate for the amount of air removed by the ventilation system. Without a proper balance, abnormal atmospheric pressure will occur, affecting burner and appliance performance. If air movement is a concern, adjustments should be made to correct the problem by Factory authorized service technician.

HAVING DIFFICULTY OPENING DOORS THAT EXIT THE BUILDING IS AN INDICATION THAT THE BUILDING HAS A PROBLEM WITH AIR MOVEMENT.

Do not use fans to blow air directly at the appliance. This can create air cross-currents and/or excessive drafts that interfere with the operation of the unit.

ELECTRICAL CONNECTION

DISCONNECT THE POWER SUPPLY BEFORE SERVICING.



**HIGH
VOLTAGE**

IMPORTANT: The appliance must be electrically grounded in accordance with local codes, or in the absence of local codes, with the National Electrical Code ANSI/NFPA70, or the Canadian Electrical Code CSA C22.2, as applicable.

Electrical Grounding Instructions

The appliance is equipped with a standard Nema 15-50 plug with appropriate strain relief for your protection against shock hazard and should be plugged directly into a properly grounded three prong receptacle. **Do not** cut or remove the grounding prong from this plug.

Important Electrical Precautions

Never touch anything that is powered by electricity when your hands are wet.

It is recommended to allow enough slack on the electrical cord to allow the appliance to be pulled out for proper regular cleaning and maintenance.

DO NOT USE AN EXTENSION CORD TO CONNECT THIS UNIT TO A POWER SUPPLY.

DO NOT USE THIS APPLIANCE IF THE POWER CORD IS DAMAGED.

DO NOT ATTEMPT TO REPAIR A DAMAGED POWER CORD.

DO NOT EXPOSE THE POWER CORD TO HEAT OR SHARP EDGES.

DO NOT OPERATE BROILER IF THE CORD HAS BEEN PINCHED OR HAS BEEN DAMAGED AS A RESULT OF RUBBING ON SHARP EDGES.

CLAMSHELL BROILER START UP

IMPORTANT NOTE:

Prior to installation, check the electrical supply to ensure input voltage and phase match the equipment - voltage rating and phase. Many local codes exist and it is the responsibility of the owner/installer to comply with these codes.



Certified
Installer

Ensure power supply is connected to the appliance.

Remove all factory applied protective material by washing with hot water, mild detergent, or a soap solution.

NOTE: Each clamshell broiler has been factory tested and adjusted prior to shipment. It may be necessary to further adjust the unit as part of a proper installation. Such adjustments are the responsibility of the installer. Adjustments are not considered to be defects in material and workmanship and are not covered under the original equipment warranty.

Remove stainless steel plastic film cover

Removing this film is one of the things that must be done once the broiler is in place. The film covers both internal and external components (e.g. Side panels, crumb tray, grease shield) and must be removed before turning the broiler on.

1. Using a plastic scraper wedge the film away from the stainless steel.
2. Grasp and pull the film very gently away from the stainless steel.

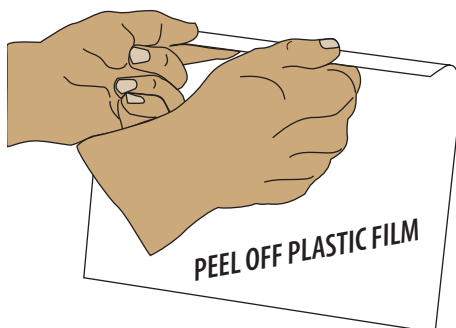

Temperature Verification



HOT SURFACE

Grill Temperatures
Will Cause Severe
Burns

Embedded heating elements and thermocouples in ductile cast iron grates allow a maximum temperature of 520°F/271°C .

Infrared heating elements allow for a maximum temperature of 700°F /371°C.

The upper and lower clamshell broiler cooking surfaces must be cleaned.

The broiler is designed and rated for operating conditions where the temperature is above 32F.

1. The upper and lower clamshell broiler should be at operating temperatures to perform this calibration procedure (approximately 30 minutes).
2. Place temperature probe over the thermocouples as per figure #1 (under: thermocouple locations diagram). Allow 5 to 10 seconds for the pyrometer to respond and stabilize temperature.
3. Temperature delta between pyrometer and controller must be +/- (20°F). If temperature delta between pyrometer and controller is greater than +/- (20°F), call Garland Technical Service Group at 1- 855-586-1542.

LOWER THERMOCOUPLE LOCATIONS

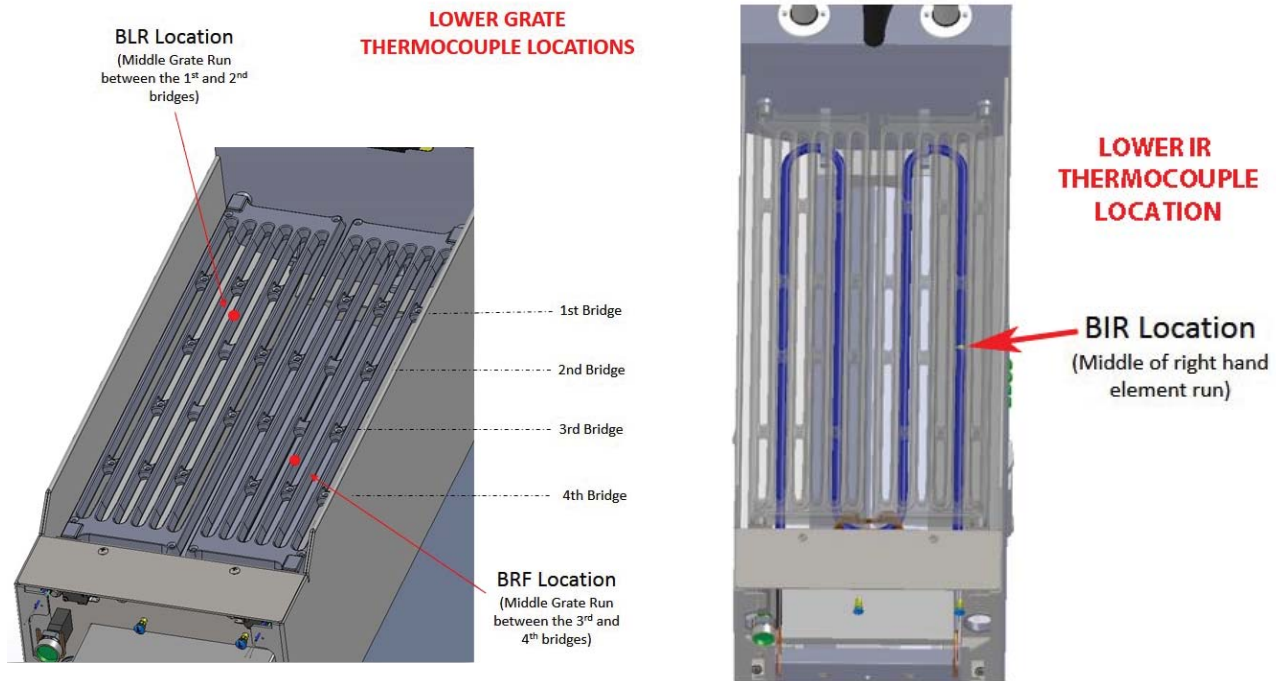

UPPER THERMOCOUPLE LOCATIONS

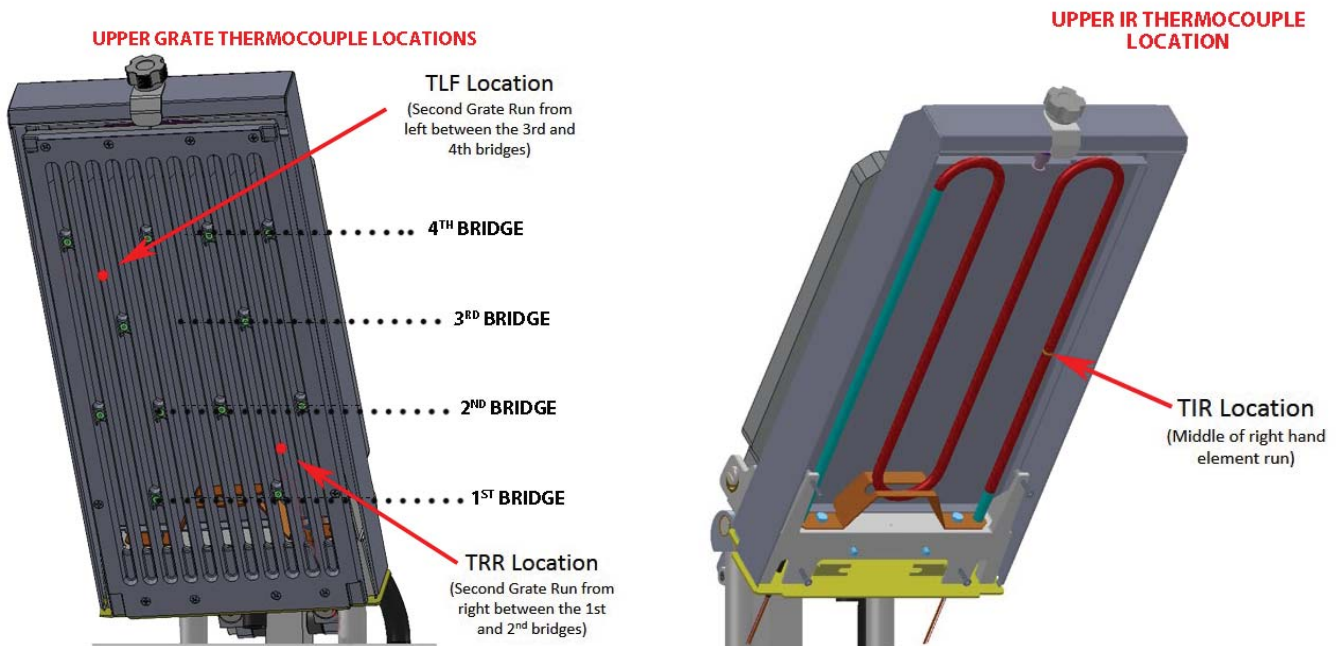

THERMOCOUPLE LOCATIONS DIAGRAM

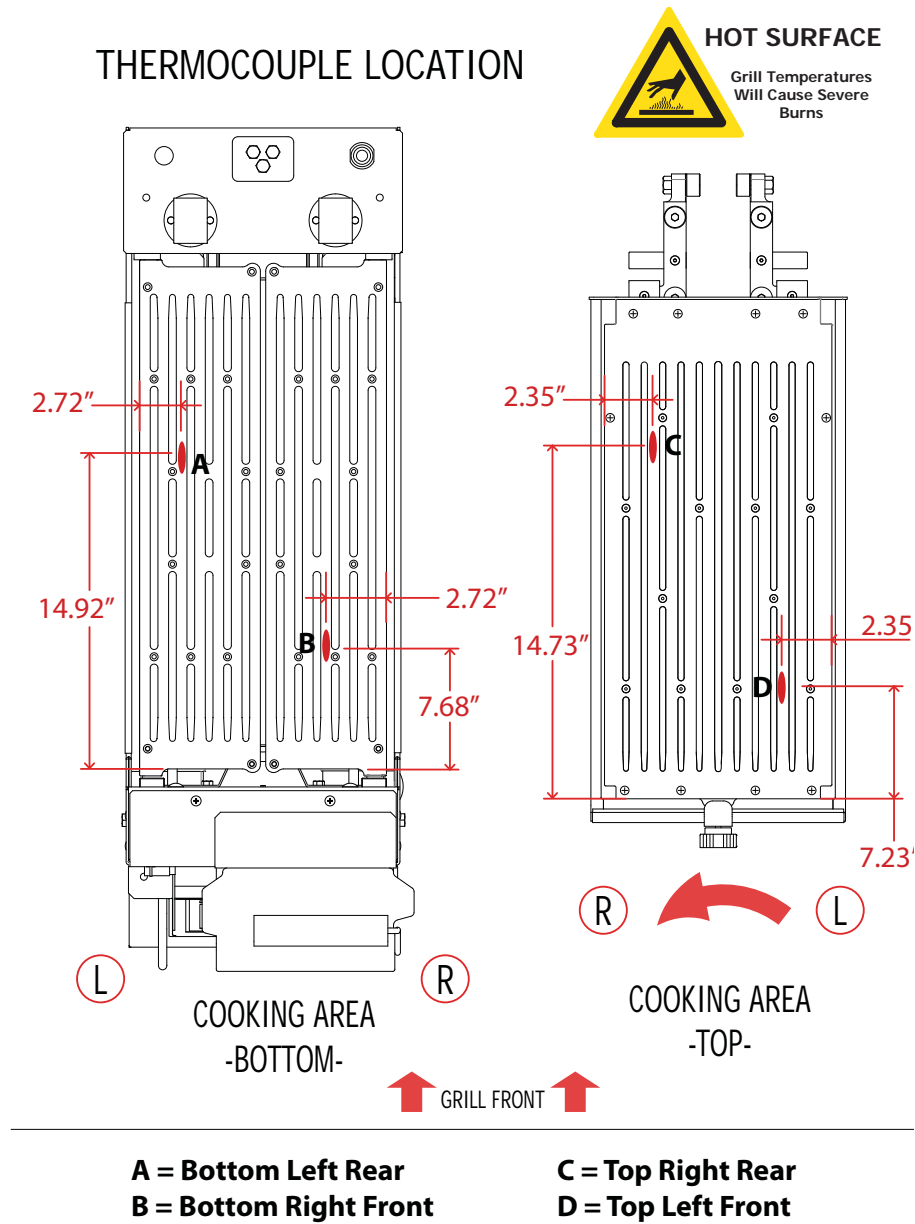

Figure #1

Startup Form Procedure

A factory startup is a comprehensive clamshell broiler check in which a factory certified technician will document all final settings programmed in the controller once various other performance checks are complete. The estimated time to complete a startup is approximately 1.5 – 2 hours. Please keep in mind this estimated time when scheduling the startup. After hours or overtime is not covered under warranty and will be billed at a charge which is the difference between the Garland Reimbursement rate and the Factory Authorized Service Centers overtime charges. A factory startup is necessary to start the warranty period. The Authorized Service Center is required to complete the paperwork during the startup process, and send it to Garland Commercial Ranges for reimbursement. At the time of receipt, Garland will start the warranty as mentioned in the Warranty section.

START UP CHECKLIST SAMPLE

Garland		START UP CHECKLIST			
Serial #:			Date:		
CFA Store #:			Phone #:		
Address:					
City:		State:		Zip Code:	
ELECTRIC / 3 PHASE INPUT SPECIFICATION: 208V MEASURE VOLTAGE FROM OUTLET: L1-L2 L2-L3 L3-L1					
1	Confirm if the outlet in the store is NEMA15-50R by checking the box on the side. If the outlet is other than NEMA15-50R, DO NOT INSTALL the clamshell broiler until this issue is resolved. Call Garland Service at 1-855-586-1542.				OK <input type="checkbox"/>
2	Remove unit from package. Inspect for any obvious shipping damage. Shipping material under the platen will be removed at a later step.				<input type="checkbox"/>
3	Remove side panel and ensure line cord is secured to the contactor. Check all wiring at the terminal block for tightness. Check all pin connectors to ensure they are secure.				<input type="checkbox"/>
4	Remove existing unit (if applicable) and place new Chick-fil-A Clamshell Broiler in place under the hood and plug in with the available outlet.				<input type="checkbox"/>
5	Ensure clamshell broiler is leveled side to side, front to back and diagonally in location under the hood. Provide details if unable to level: Check box to confirm best possible level was achieved.				<input type="checkbox"/>
6	Turn on power switch. Note the SW version, SW # (update if required).				<input type="checkbox"/>
7	Ensure control initiates, the platen completes the HOMING sequence, and the display goes to the HOME screen.				<input type="checkbox"/>
8	Remove all packaging materials underneath the platen.				<input type="checkbox"/>
9	Spray Kay Release Agent provided by location to both the upper and lower grates.				<input type="checkbox"/>
10	Press the PRESS&GO icon. Ensure the clamshell broiler goes to preheat.				<input type="checkbox"/>
10	RECORD VOLTAGE FROM CONTACTOR	L1-L2:	L2-L3:	L1-L3:	<input type="checkbox"/>
11	Ensure the clamshell broiler pre-heats, reaches set points, soaks and that platen raises and goes to ready state.				<input type="checkbox"/>
12	Fill in the following table:				
	ZONE	Set Point	Max Actual	ZONE	Set Point
	TRR (Top Right Rear)			BRF (Bottom Right Front)	
	TLF (Top Left Front)			BLR (Bottom Left Rear)	
	TIR (Top Infrared)			BIR (Bottom Infrared)	
13	Flip each of the bottom grates <u>individually</u> to ensure that each will properly cut off the supply of the high voltage when opened. Verify that switch mounts are tight. Adjust micro switch bracket if necessary. Check the box to confirm that the switches were both properly set.				<input type="checkbox"/>
14	Ensure customer confirms the Hood Height is practical. Adjust the hood height as required.				<input type="checkbox"/>
15	Verification of the factory TEMP BIAS: Probe the broiler's thermocouples immediately after a simulated cook cycle and compare them to the control outputs.				<input type="checkbox"/>
	ZONE	OFFSET (°F)	ZONE	OFFSET (°F)	<input type="checkbox"/>
	TRR (Top Right Rear)		BRF (Bottom Right Front)		
	TLF (Top Left Front)		BLR (Bottom Left Rear)		
16	Run the clamshell broiler without product on the grates and confirm normal functioning of the following:				<input type="checkbox"/>
	Ability to put the clamshell broiler into SLEEP MODE.				<input type="checkbox"/>
	Proper functioning of green button to start, stop and acknowledge.				<input type="checkbox"/>
	Proper and noise free operation of the Exhaust Fan.				<input type="checkbox"/>
	Proper functioning of the speaker. Confirm volume level with store operator and adjust as required.				<input type="checkbox"/>
17	Ensure all panels are tightly secured and attach any tool storage bins provided.				<input type="checkbox"/>
18	If possible, assist or obtain assistance from store personal to perform <u>product integrity testing</u> on chicken ensuring they fall within the accepted parameters. Record temperature below:				<input type="checkbox"/>
	RIGHT SIDE (°F)	1	3	5	7
	LEFT SIDE (°F)	2	4	6	8
	Verify satisfactory exhaust fan smoke capture thru complete cook cycle. Adjust the exhaust shutter as necessary and check box to acknowledge adequate smoke capture.				<input type="checkbox"/>
19	DO NOT level or calibrate platen unless product integrity test has failed. If calibration is required, call Garland Service for assistance. Level and Calibrate the platen. Ensure that the jam nuts are tightened and that all caps are in place. Record current platen position number: and confirm that the clamshell broiler was leveled and calibrated. Power cycle the broiler after calibration. Go back to 18.				<input type="checkbox"/>
20	Confirm Taylor Grill has been removed from restaurant. Taylor Serial #				<input type="checkbox"/>
21	Problems / Special Circumstances / Damage:				<input type="checkbox"/>
SUBMITTED BY:			ACCEPTED BY MANAGER:		
Name: _____			Name: _____		
Signature / Print name			Signature / Print name		
SERVICE AGENT:			I have been adequately informed on the operation of the clamshell broiler, its use and general operation?		
SUB-AGENT(if applicable):			Y <input type="checkbox"/> N <input type="checkbox"/>		
Have you trained the store on the operation of the clamshell broiler? (30 minutes)			Y <input type="checkbox"/> N <input type="checkbox"/>		
Are you a factory certified technician?			Y <input type="checkbox"/> N <input type="checkbox"/>		
Date of certification:			I have been adequately informed on the maintenance of the clamshell broiler?		
			Y <input type="checkbox"/> N <input type="checkbox"/>		
			COMMENTS:		
<p>Note: See Installation Operation Manual for detailed instructions on the clamshell broiler and control functionality.</p> <p>This form is to be faxed to the RISE Call Center (727-569-1247) or by email via Rise.callcenter@manitowoc.com immediately upon completion from the Chick-fil-A site.</p>					
Part#4532160 / Rev05					

FRONT CASTERS ADJUSTMENT

1. Turn the clamshell broiler Green Power Main Switch OFF. ("0" position)

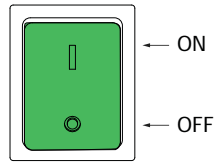

6. Loosen caster jam nut by turning it clockwise with a wrench.

7. Adjust the caster assembly by turning the caster (brake on) clockwise to increase the height or counterclockwise to decrease the height.

8. After the broiler is completely level, tighten caster jam nut to secure the caster assembly.

2. Rear Casters are fixed - DO NOT ATTEMPT TO ADJUST THEM.

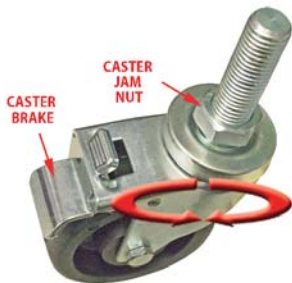

3. Adjust the two (2) front casters only.

4. Lock the caster using the caster brake (Note: applying the caster brake system will lock the wheel and the swivel of the caster assembly).

5. Carefully raise front of unit slightly so that front wheels are off the ground and no longer bearing unit weight.

IMPORTANT NOTE

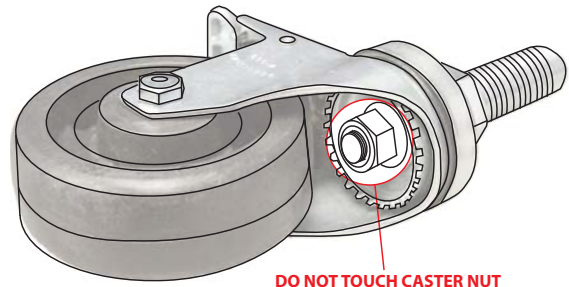

On the caster assembly shown above there is a nut used to assemble the swivel system - do not use wrench on this nut. This nut is intended for the caster swiveling system only.

LATCH SYSTEM INTERNAL OPERATION - A, UNLATCHING

Check list for the top platen grate latch mechanism and the to the cowl assembly:



Objectives

Recognize basic Latch requirements:

- Identify the locking pin stages.
- Identify the grate anchor and the tether anchor.

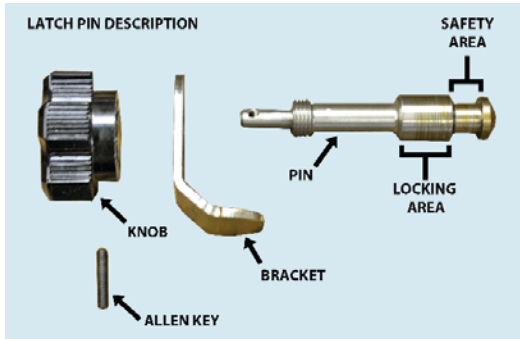

How to unlatch top grate from cowl assembly.

Untighten knob counterclockwise approximately five turns (as shown in figure #1), until grate drops approximately 1/4" to a safety lock, not allowing the grate to drop all the way down (as shown in figure #2).

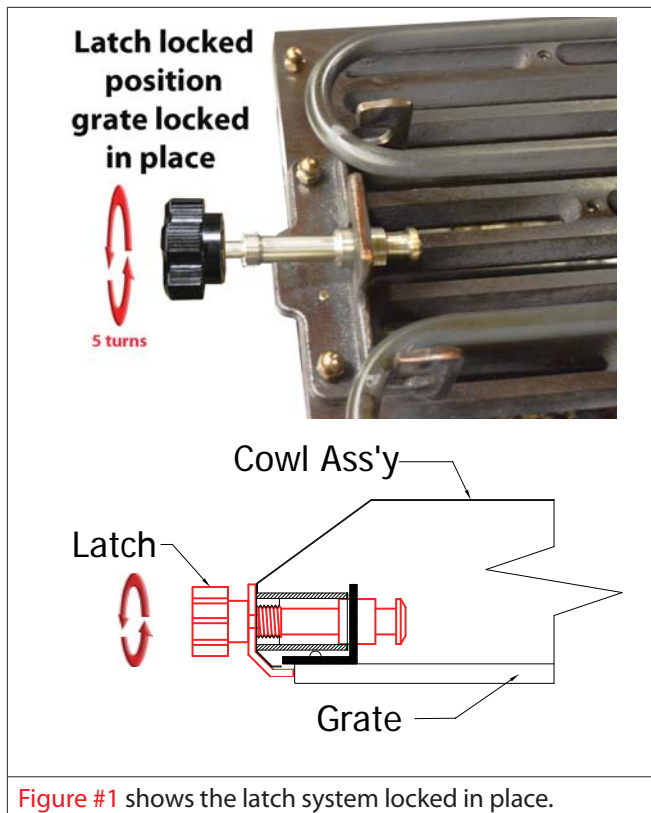

Figure #1 shows the latch system locked in place.

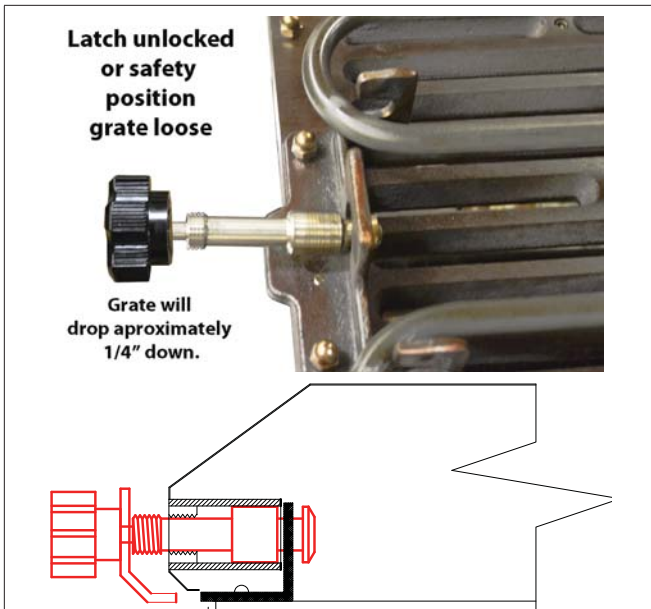

Figure #2 shows the latch system in safety place.

Simultaneously push the grate up while pulling the knob out to release the grate as shown in figure #3. (Knob does not come out of the cowl assembly) Grate can now separate from the cowl assembly. Keep holding the grate until the resting position.

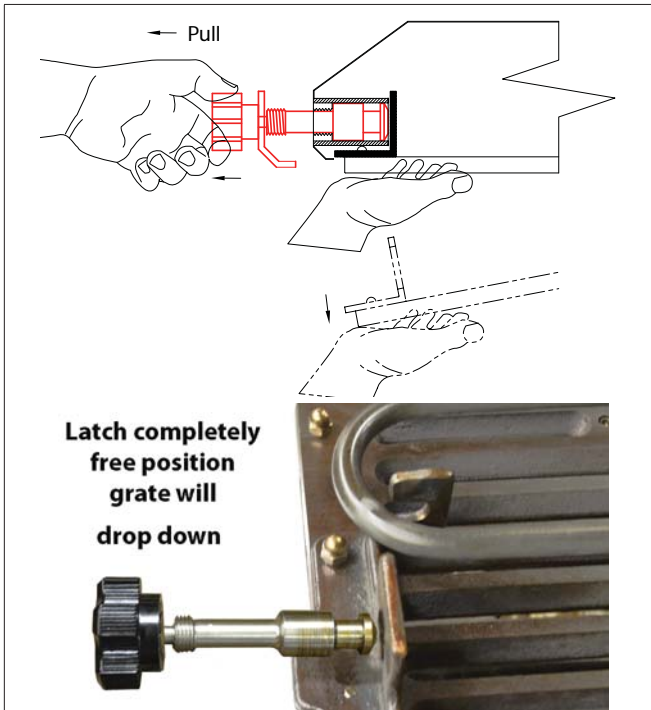

Figure #3 shows the latch completely un-latched from the cowl assembly.

Important note: Hand support should be maintained until the grate is fully locked in closed or open resting position, to prevent the sudden drop of the grate assembly.

LATCH SYSTEM INTERNAL OPERATION - B, LATCHING



How to latch the top grate to cowl assembly.

While pulling the knob, with the other hand lift up the upper grate, (as shown in figure #4).

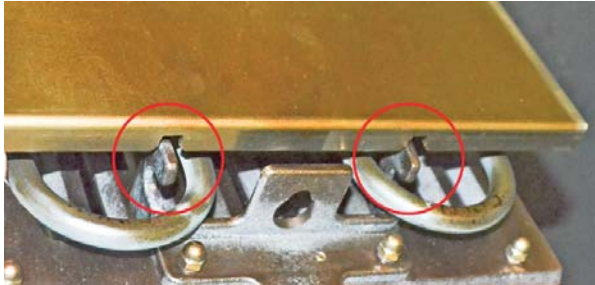

Note: Ensure the upper grease shield is in the right place aligning the two notches as shown above.

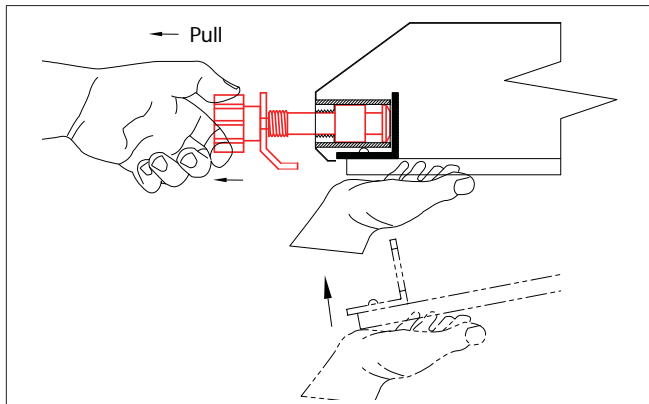

Figure #4 shows the grate being moved up to latching position.

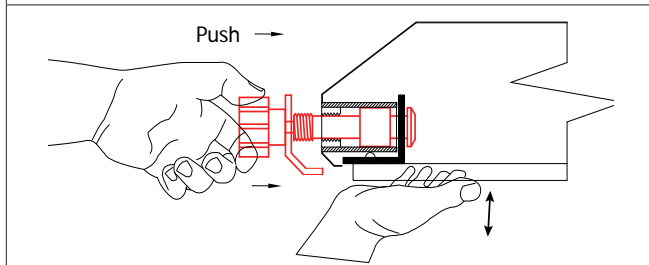

Figure #5 shows the latch system passing through safety lock area.

Push knob until latch passes through the safety lock and into the locking position. The grate may have to be moved slightly up/down.

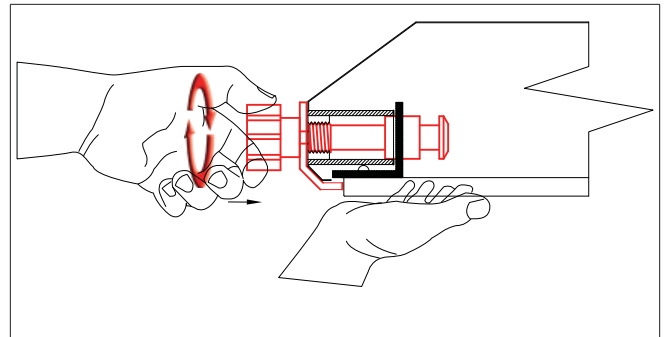
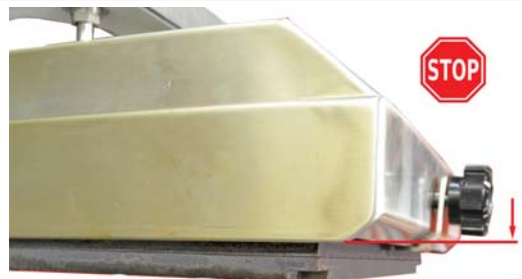

Figure #6 shows the latch completely latching the grate to the cowl assembly. Turn knob approximately 5 turns, until you feel resistance.

Important note: Hand support should be maintained until the grate is fully locked in place, to prevent the sudden drop of the grate assembly.

How to check:

Knob should be turned clockwise only finger tight. Ensure the bracket is tight, in place and there is no gap on either side of the bracket.



Incorrect:
Grate not in place, front side too low compared to rear side.



Correct:
Grate in place, with consistent gap.

LOWER GRATE ADJUSTMENT PROCEDURE

Lower grates need to be at an even height or position relative to each other for proper cooking performance.

- Turn broiler off and disconnect power supply.
- Let the broiler grates cool down.



HOT SURFACE
Grill Temperatures
Will Cause Severe
Burns



PPE
Approved Personal
Protective Equipment
Must be worn

Objectives;

- Verify right and left lower grate alignment.
- Make the proper adjustment to align grate as required.

How to verify lower grate assembly align.



Figure #1, shows the the two lower grates.

- Lower grates into the lower position as shown in figure#1.
- Using the block tool verify the alignment of the grates.

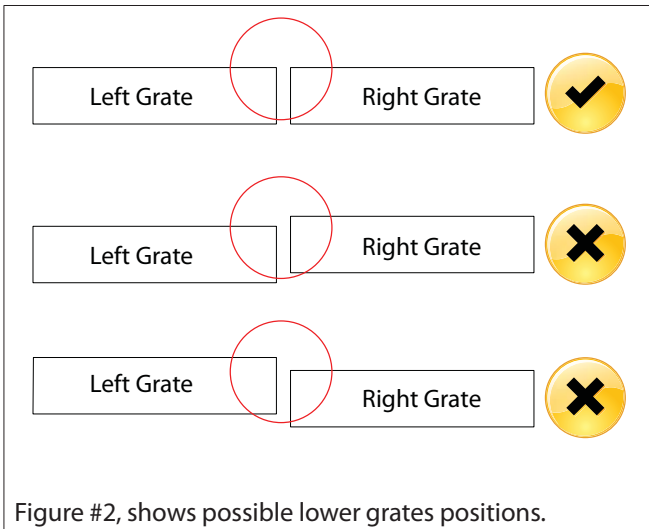

Figure #2, shows possible lower grates positions.

- make proper adjustment according to the results.



Good, no adjustment required.



Grates proper adjustment required.

How to align lower grate assemblies.

- Raise upper platen
- Lift up right and left lower grates.



Figure #3 shows the stop block grate supports.

- Unscrew the four (4) screw, see figure #4 and remove back panel, place it a side.

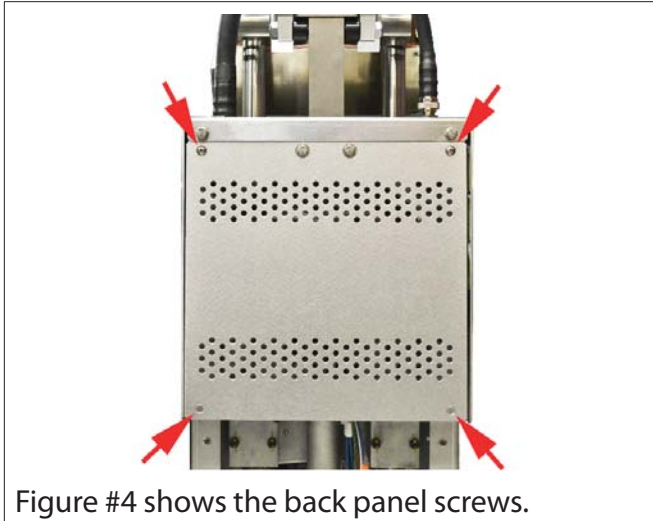

Figure #4 shows the back panel screws.

- Using a socket with an extension, slightly loosen the bolts of the stop block, two (2) bolts each block, see figure #5

LOWER GRATE ADJUSTMENT PROCEDURE, *continuation*

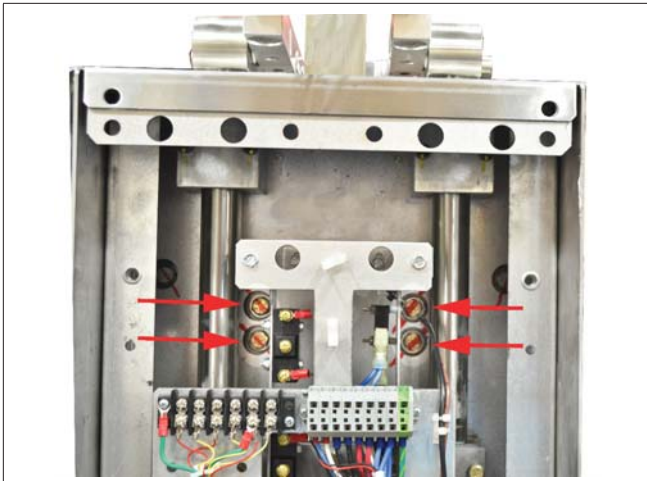



Figure #5 shows the back four (4) bolts of the stop block.

- Tap the stop blocks to move them up or down, and gently move the grates until they are aligned. As shown on figure #2 .

- Tighten the four (4) bolts to secure the stop blocks in place.

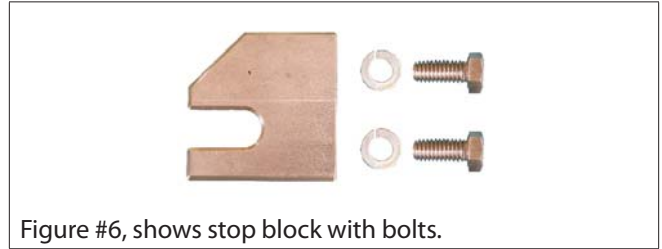

Figure #6, shows stop block with bolts.

- Re-install the back panel and test the unit or proceed with the upper platen levelling.

GAP CALIBRATION & UPPER PLATEN ASSEMBLY LEVELLING

The broiler upper platen grate/cowl assembly needs to be parallel with lower grates for a maximum performance. Follow the next steps for upper platen calibration.

Objectives;

- Identify proper steps through the program.
- Identify locking pin on the platen arm assembly.
- Identify the proper adjustments required to level the cowl assembly.

How to level top grate from cowl assembly.

Please review and follow these instruction accordingly;



1. Turn Broiler main switch on and panel will go to HOME SCREEN as shown.

2. Select/press "SETTINGS"



3. Select "SUPER USER" and enter password and press RETURN, be aware computer allows three (3) attempts only.



4. Select "GAP CALIBRATION" and press "START". The platen will move down to the home position, and the relative platen position will be shown in the "Current Platen Position Box"

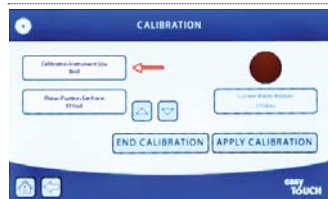

5. Select/press "Calibration Instrument Size"

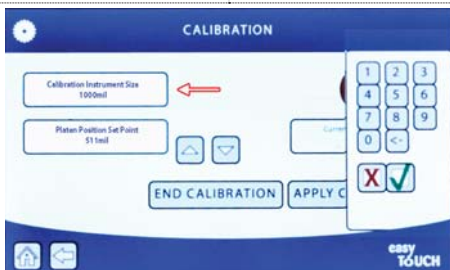

6. Numeric keypad will show at the side, key in dimension of the gauge being used in mils and press "✓" mark, for example, number 875 mils should be entered if using gauge part number 4532541.

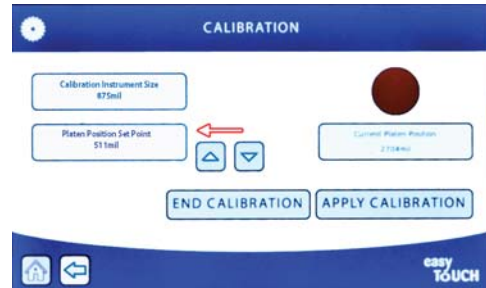

7. Select/press "Platen Position Set Point"



8. Numeric keypad will show at the side, key in number 2300 and press enter. Number will show in the "Set Platen Position" box and platen will rise.

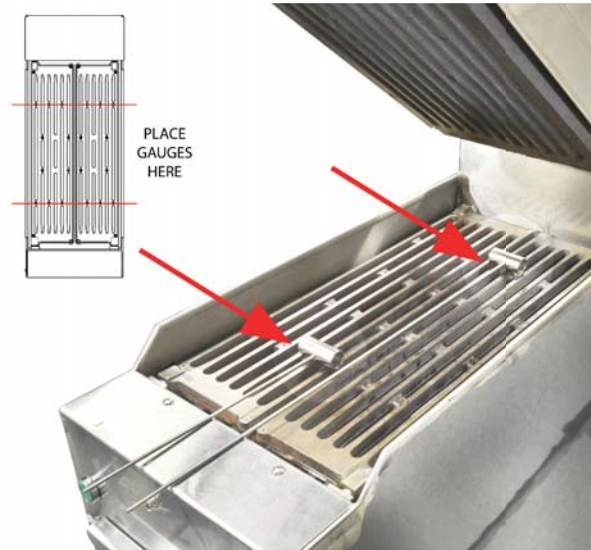

9. Proceed with placing the gap tools in place; position the gauges between the two lower grates. If lower grates are uneven, place the gauge on the lower of the two grates (note: although the lower grates may be uneven at some places from front to back, they should be flush at some point. If not, than they should be adjusted before calibrating gap, see lower grate adjustment procedure).

GAP CALIBRATION & UPPER PLATEN ASSEMBLY LEVELLING, *continuation*

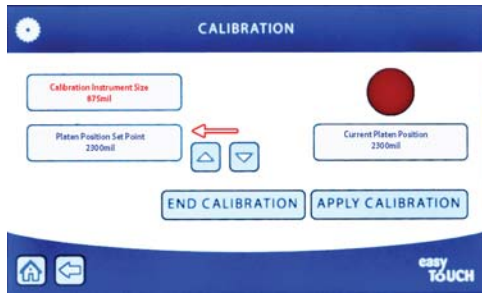

10. Select/press "Platen Position Set Point"

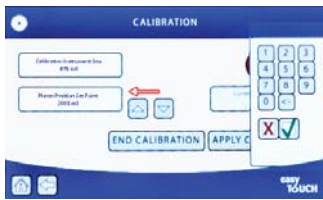

11. Numeric keypad will show at the side. Key in number that is 100 mils "greater" than the gauge being used and press enter. (Enter 975 mils in our example)

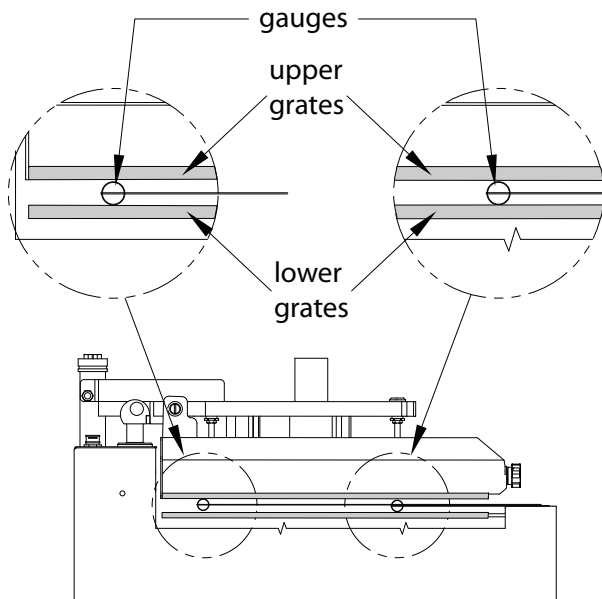

12. Upper platen will lower. Next step will be a visual inspection to check if the gap between the gauge and the upper grate are equal, both front and back. If not, adjustment needs to be done through the front adjuster nuts located on front of the platen arm assembly as described in step 13 to 17. If no adjustment is needed, go to step 18.

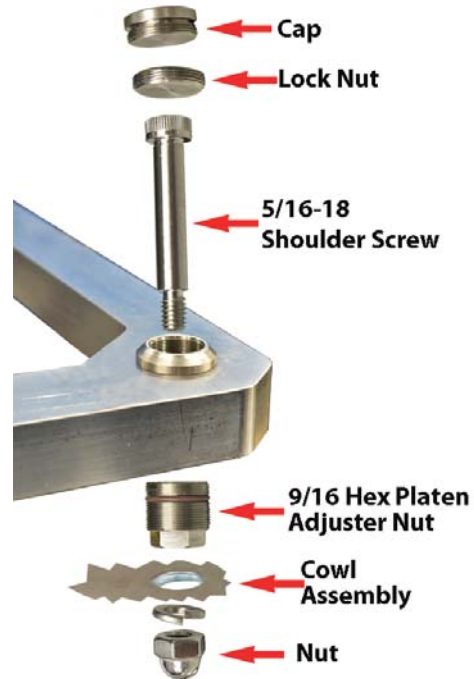

Figure 1 shows the adjustable system of the cowl assembly.

UPPER PLATEN LEVELLING

13. Using a flat screwdriver or the platen adjusting tool (B), remove the platen grease caps and the lock nut.

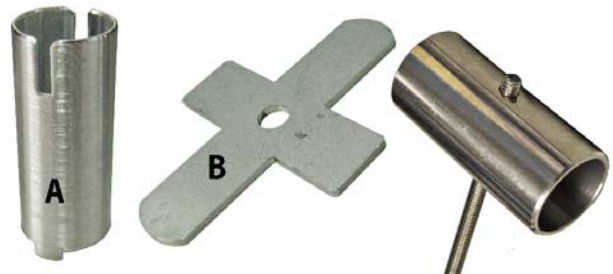

Figure 2 shows tool required for platen calibration.

14. Move next to the adjuster nut and raise or lower the front of the upper platen, and adjust until both gauge gaps are equal using the calibration tools "A&B" as shown in figure 2.



GAP CALIBRATION & UPPER PLATEN ASSEMBLY LEVELLING, *continuation*

15. After the platen is levelled, check to ensure that for each adjuster nut, the “O” ring is not visible and that at worst case the threaded portion is flush with the arm.

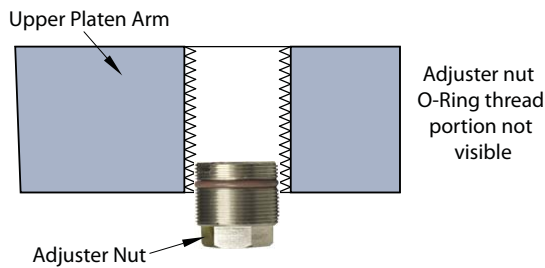
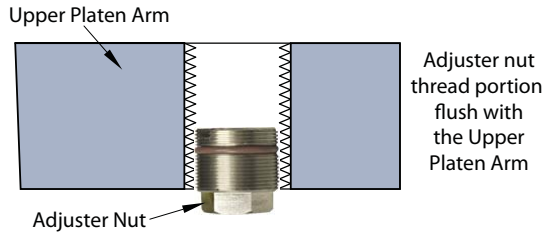
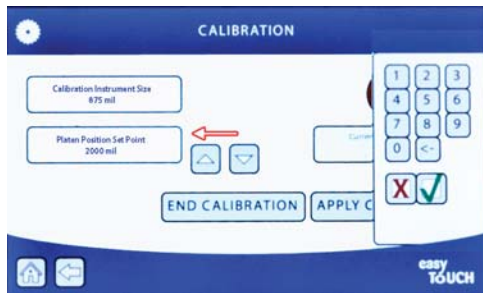

Figure 3 shows the blocks in place.

16. Place & tighten the top lock nut and use the flat wrench and a screwdriver to jam the lock with the adjuster nut.

17. Replace the grease cap and tighten.



18. Use the platen “Platen Position Set Point” button to slowly lower the platen until it is barely touching the gauge blocks. Once touching, raise the platen slightly (10 mils) to confirm that the blocks are now loose, and then come back down 10 mils to again establish contact. Adjust the platen height as required to satisfy this 10 mils gauge movement test. If the amount of contact is different front to back, then do further adjustments of the platen level to correct.

NOTE: TAKE CARE NOT TO SEND PLATEN TOO FAR. MOVE IN SMALL INCREMENTS TO PREVENT DAMAGE TO GRATES!

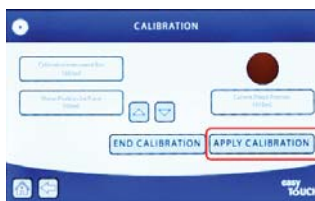

19. Select/press “Apply Calibration” to lock in calibration setting.

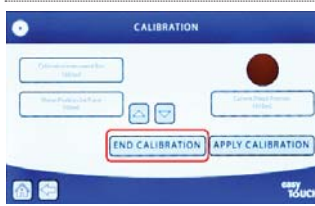

20. Select/press “End Calibration” to exit screen. Calibration completed

EXHAUST MOTOR FUSE REPLACEMENT



ELECTRICAL
HAZARD

Warning: Always disconnect electrical power before removing panels.

1. Turn the clamshell broiler Main Green Power Switch OFF. ("0" position)

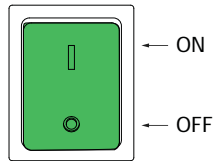

2. Remove front panel by removing the two (2) Phillips screws on top as shown in the picture above, save screws.

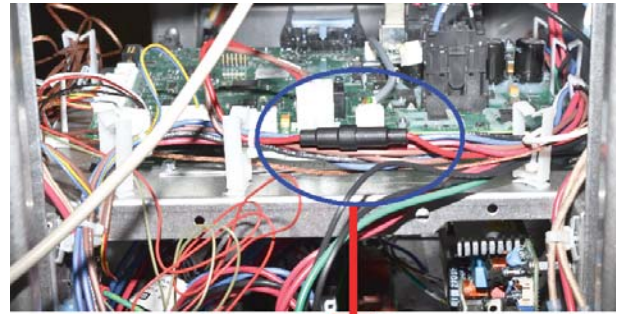

3. Cartridge fuse holder located in the harness contains a glass fuse inside and is shown in the picture above. Hold both ends and turn the right end counterclockwise to open and remove fuse.



4. Check fuse and replace with a new one if needed. Install fuse in the holder, hold both ends and turn the right end clockwise to close the cartridge fuse holder.

5A
(size 0.185" dia x 0.57")



Ensure the new fuse has the right fuse rating.

EXHAUST MOTOR ASSEMBLY REPLACEMENT



Warning: Always disconnect electrical power before removing panels.



HOT BROILER

Broiler temperature extremely high, be very careful.

Note: allow clamshell broiler to cool for approximately 20 minutes before performing this procedure.

1. Press the **GREEN** button to lower upper platen if not already down.

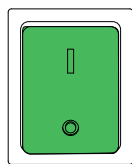
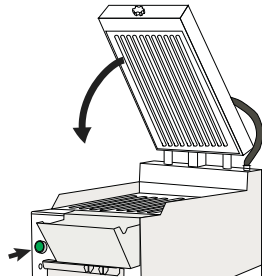

2. Green turn the clamshell broiler Main Power Switch OFF. ("0" position)

3. Disconnect the electric conduit coupling at the back of the broiler.



4. Gently pull the coupling up allowing the two (2) wire connectors pass through the lower part of the coupling (note: do not pull hard as coupling could damage the wire connectors).

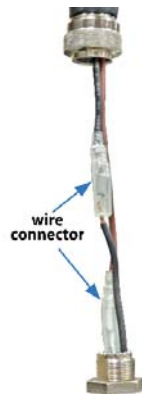

5. Remove the three (3) thumbscrews located around the motor.

6. Remove blower wheel using a 3/32" Allen wrench, if blower wheel is not being replaced.

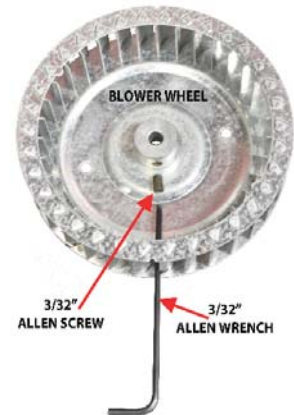

Reinstall blower wheel to the motor

7. Be aware that the shaft of the motor has a small cut off at the end.

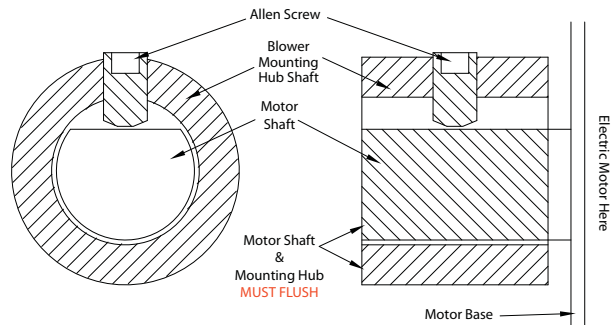
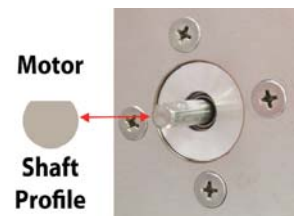

8. Insert the blower mounting hub onto the motor shaft aligning the Allen screw with the flat surface on the motor shaft. The end of the motor shaft must flush with the end of the blower mounting hub leaving enough space between the base of the motor and the blower wheel.

9. Tighten the Allen screw using a 3/32" Allen wrench.

10. Install motor assembly reversing steps 1 to 5.

LOWER GRATE REPLACEMENT PROCEDURE

- Turn broiler off and disconnect power supply.
- Let the broiler grates cool down.

How to replace lower grates assembly.



HOT SURFACE

Grill Temperatures Will Cause Severe Burns



PPE

Approved Personal Protective Equipment Must be worn

1. Remove the oil tray assembly and the grease drawer.



2. Using Phillips #2 screwdriver remove the two (2) screws on top and three (3) screws on front of upper front and remove panel. Similarly remove two (2) screws retaining lower control panel and remove panel. Disconnect USB cable from housing panel.

3. Remove the six (6) screws retaining the left side panel using the same screwdriver in step #2.

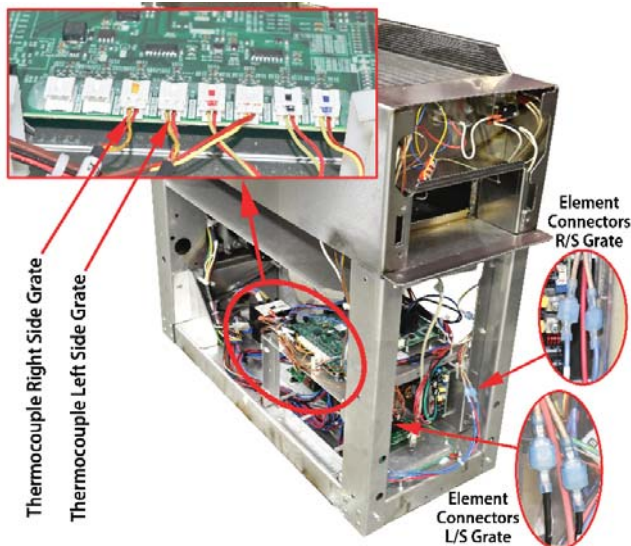

4. Disconnect the thermocouple from the System Interface Board (SIB) located on the right side of the unit. The connector on the right represents the left bottom grate and the connector on the left represent the right bottom grate (photo above).
5. Disconnect the element grate connection located behind the lower front panel. Cut ties to free wires.
6. Using a Phillips #2 screwdriver disconnect the grate ground wire from the pivot tube (photo below)

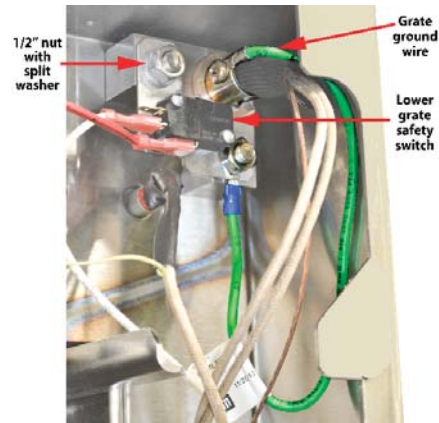

7. Remove the two (2) 1/2" nuts from the pivot bushing, put the safety lower grate switch a side.



8. Remove the two (2) carriage bolts, save them for later use.
9. Remove the pivot bushing assembly, save part for the re-assembly.



10. Lift up grate, push it forward to remove grate from rear bushing, and take grate completely out of the broiler.
11. To install a new grate, reverse the process.

LOWER INFRARED ELEMENT REPLACEMENT PROCEDURE

First step will be safety;

- Turn broiler off and disconnect power supply.
- Let the broiler grates cool down.



Procedure on how to replace lower infrared element assembly.

1. Remove the oil tray assembly and the grease drawer. Remove the top front panel and the lower front panel using a Phillips #2 screwdriver.



2. Disconnect the infrared element connectors and remove wire free from cable tie.

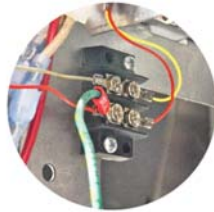

3. Remove the four (4) 7/16" hex bolts & nuts from the front of the broiler.



4. Gently remove the old lower infrared element and replace the new one.
5. Replace and tighten the four (4) 7/16" size hex bolts & nuts (element bracket).
6. Reconnect the new infrared elements end terminals connectors.
7. Test Broiler and then Reinstall front panels.

UPPER GRATE ELEMENT REPLACEMENT PROCEDURE

First step will be safety;

- Turn broiler off and disconnect power supply.
- Let the broiler grates cool down.



HOT SURFACE

Grill Temperatures
Will Cause Severe
Burns



PPE

Approved Personal
Protective Equipment
Must be worn

Procedure on how to replace upper grate element assembly.



1. Lower the top platen and remove top rear panel, four (4) screws using Phillips #2 screwdriver.

2. Disconnect all connectors and cut the ties.

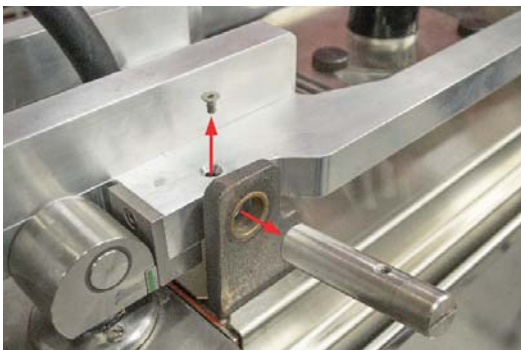

3. Remove the two (2) 1/8" Allen screws from the top of the arm assembly and slide out the pin.

4. Release the grate from the front latch system, for more information see "Latch System Internal Operation" in this manual.



5. Lift up the cowl assembly, remove the grease shield and then remove the grate assembly by sliding it forward.

6. Careful, the grate is very heavy.

7. To Instal a new upper grate reverse the process.

READING THE LED'S FROM SOFTWARE INTERFACE BOARD (SIB)

Reading the LEDs - SIB

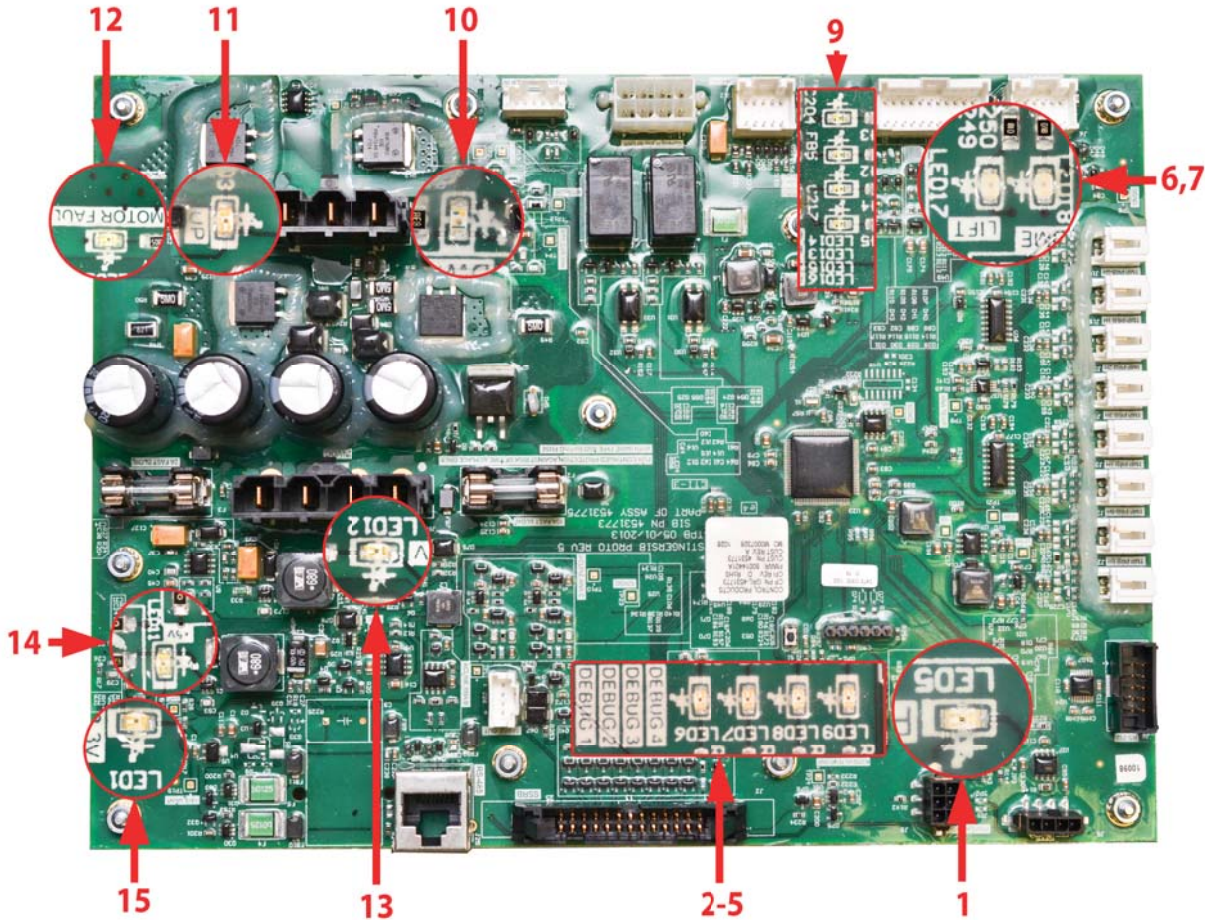

The SIB has a number of LEDs performing different functions. For the Service Technician, the most important ones are numbers 1, 6, 7, 10, 11, and 12. If LED 1 is not blinking there may be an issue with the high voltage power or with the ribbon cable to the SSRB.

LED 6 & 7 reflect the status of the Home and Upper reference switches. At least one of these must ALWAYS be on.

- When the platen is down (at or below the Home switch), LED 6 is OFF
- When the platen is up (at or below the Upper switch), LED 7 is OFF
- When the platen is between these positions, LED 6 and 7 are ON

LED 10 and 11 indicate that the platen motor is moving or trying to move.

LED 12 indicates a problem when the platen motor is moving or trying to move, such as over-current.

If the actuator check validates a good actuator and the platen still gets stuck, or shuddering, or UI displays error# 2, then some mechanical adjustment may be done, such as releasing the seals and seal caps (2 screws); move platen a few times up/down. If no change in behavior before or after tightening back the seal caps, change actuator.

Location	Color	Name	Meaning
1	Red	Pwr Synch	Blinks when high voltage detected from SSRB
2	Red	Debug 1	On during normal operation
3	Red	Debug 2	Blinks during normal operation
4	Red	Debug 3	Blinks rapidly during normal operation
5	Red	Debug 4	Blinks when SIB software updates, lights if error between SIB and UI
6	Amber	Home	On until platen is at the home switch (or lower)
7	Amber	Upper	On until platen is at the upper switch (or higher)
8	Green	Heartbeat	Blinks during normal operation
9	Blue	Green Button	Lights while green button pressed
10	Blue	Motor Down	Lights while platen motor moving down
11	Green	Motor Up	Lights while platen motor moving up
12	Red	Motor Fault	Blinks momentarily during boot and if motor goes over current
13	Green	12v Power	Constant when power supply connected
14	Green	5v Power	Constant when power supply connected
15	Green	3.3v Power	Constant when power supply connected

READING THE LED'S FROM SIB - DIAGNOSE PLATEN ERRORS

Position Indicators

Check the amber LEDs 6 & 7 on the SIB:

LED 6 (HOME)	LED 7 (UPPER)	
ON	OFF	PLATEN MUST BE UP (AT OR ABOVE THE UPPER SWITCH)
OFF	ON	PLATEN MUST BE DOWN (AT OR BELOW THE HOME SWITCH)
ON	ON	PLATEN MUST BE BETWEEN THE HOME AND UPPER SWITCHES
OFF	OFF	ERROR - AT LEAST ONE LED MUST BE ON

If the platen position does not correspond to the LED pattern, check that the Position Sensor connector is properly seated on the SIB (front left corner) and that it is wired correctly.

Motion Indicators

Check the LEDs 10, 11 & 12 on the SIB:

LED #	COLOR	
10	BLUE	MOTOR IS MOVING DOWN
11	GREEN	MOTOR IS MOVING UP
12	RED	ERROR - MOTOR IS OVERCURRENT

If LED 10 or 11 is lit, the motor is trying to move the platen. If LED 10 is lit and platen is at the bottom the motor may be on the lower overtravel switch. Similarly, if LED 11 is lit and platen is fully open the motor may be on the upper overtravel switch.

If LED 12 is lit or blinking while the platen is moving, the SIB has detected an overcurrent condition, and there may be binding or an obstruction at some part of the mechanism.

Check that the motor encoder connector is properly seated on the SIB (front middle-right) and that it is wired correctly.

READING THE LED'S FROM SIB - PLATEN HOMING

Platen Homing Behavior

At the start of the homing process, the controller first determines if the platen is at the upper switch. If it is, the platen starts moving down. Otherwise, the platen moves up by as much as 1000 mils before moving down.

If platen starts at or above the upper switch:

LED 6 (amber)	LED 7 (amber)	LED 10 (blue)	LED 11 (green)	LED 12 (red)	
Home	Upper	Down	Up	Overcurrent	
ON	OFF	OFF	OFF	OFF	Initial LED state
ON	OFF	ON	OFF	OFF	Platen starts moving down
ON	ON	ON	OFF	OFF	Platen continues to move down
OFF	ON	ON	OFF	OFF	Platen reaches home switch
OFF	ON	OFF	ON	OFF	Platen begins to move back up
ON	ON	OFF	ON	OFF	Platen continues to move up
ON	OFF	OFF	ON	OFF	Platen continues to move up, past upper switch *
ON	OFF	OFF	OFF	OFF	Platen stops at hood height

If platen does not move up past the upper switch, go to Settings/Hood Height calibration to check setting.

If platen starts below the upper switch:

LED 6 (amber)	LED 7 (amber)	LED 10 (blue)	LED 11 (green)	LED 12 (red)	
Home	Upper	Down	Up	Overcurrent	
ON or OFF	ON	OFF	OFF	OFF	Initial LED state (Home may be OFF or ON)
ON or OFF	ON	OFF	ON	OFF	Platen starts moving up
ON	ON	OFF	ON	OFF	Platen continues to move up
ON	ON or OFF	OFF	OFF	OFF	Upward motion stops (Upper may be OFF or ON)
ON	ON or OFF	ON	OFF	OFF	Platen starts moving down
ON	ON	ON	OFF	OFF	Platen continues to move down
OFF	ON	ON	OFF	OFF	Platen reaches home switch
OFF	ON	OFF	ON	OFF	Platen begins to move back up
ON	ON	OFF	ON	OFF	Platen continues to move up
ON	OFF	OFF	ON	OFF	Platen continues to move up, past upper switch *
ON	OFF	OFF	OFF	OFF	Platen stops at hood height

If platen does not move up past the upper switch, go to Settings/Hood Height calibration to check setting.

Overcurrent LED 12 may blink momentarily as motion starts or stops. If it stays lit or blinks continually, actuator motor is drawing high current and may be binding or obstructed.

READING THE LED'S FROM SSRB

Reading the LEDs - SSRB

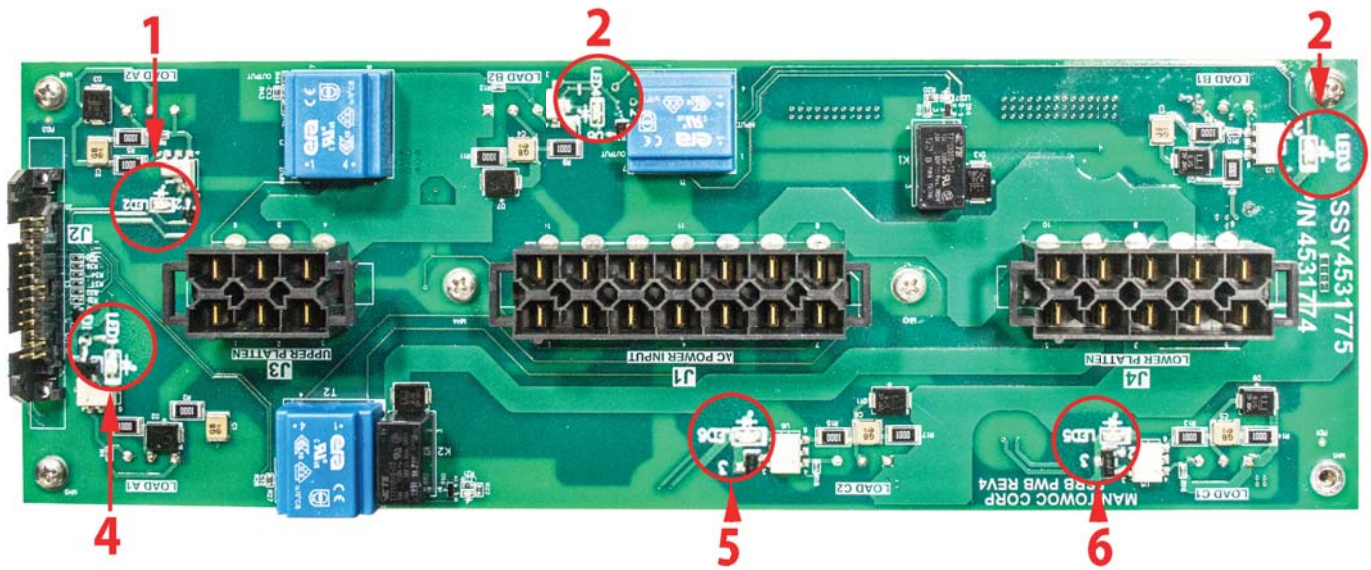

The SSRB has one LED per heater. The LEDs blink in proportion to the power being delivered to each heater:

- An LED that is always on (or nearly always) is receiving maximum power.
- An LED that is off is receiving no power.
- An LED that is blinking is receiving some power.

Location	Color	Name	Meaning
1	Red	Pwr Synch	Blinks when high voltage detected from SSRB
2	Red	Debug 1	On during normal operation
3	Red	Debug 2	Blinks during normal operation
4	Red	Debug 3	Blinks rapidly during normal operation
5	Red	Debug 4	Blinks when SIB software updates, lights if error between SIB and UI
6	Amber	Home	On until platen is at the home switch (or lower)

CLAMSHELL BROILER ACCESSORIES

Note: Accessories will be available for the broiler launch period and later can be purchased through the Chick Fil A warehouse. (subject to change)

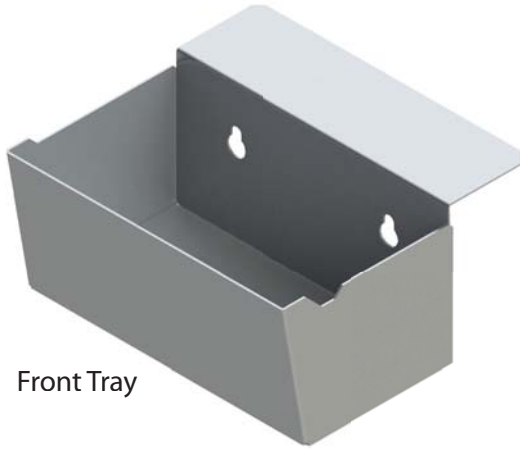

Front Tray



Disposable Front Tray

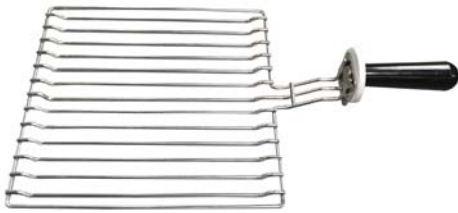

Nugget Rack

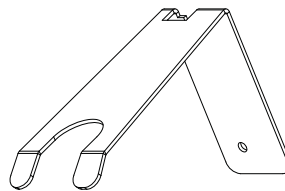

Brush Holder

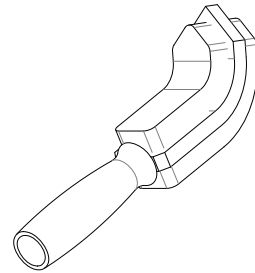

Hi Temperature Grill Brush



Scraper (not stored on broiler)

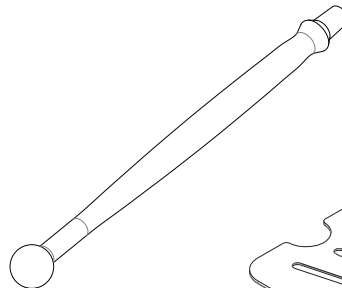

Brush Handle

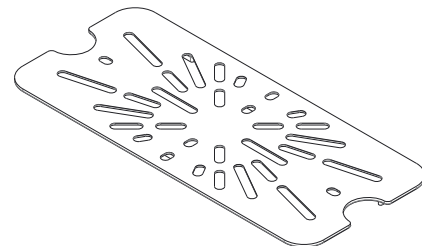

Cambro Insert
(not used on broiler)



Nugget Rack Holster



Oil Roller Handle



Oil Roller

USE AND CARE

Operation

IF FOR ANY REASON THE ELECTRICAL POWER IS INTERRUPTED OR THE CIRCUIT BREAKER IS TURNED OFF, TURN THE POWER OFF TO THE APPLIANCE BY SWITCHING THE MAIN POWER SWITCH OFF. CONTACT A FACTORY AUTHORIZED SERVICE REPRESENTATIVE BEFORE ATTEMPTING TO RESTORE THE POWER. FOR A LIST OF AUTHORIZED SERVICE AGENTS, REFER TO THE GARLAND WEBSITE AT <http://www.garland-group.com>

Shutdown

Turn main switch to the "OFF", "0" position

For extended shut down periods, turn main switch "OFF" "0" position, and unplug the electrical power cord.

NOTE: **Do not** abuse the appliance by leaving at high temperature setting when not required.

Warnings

Do not use an extension cord to connect this appliance to a power supply.

Do not use this appliance if the power cord is damaged.

Do not attempt to repair a damaged power cord.

Do not expose the power cord to heat and be careful not to damage the cord by pinching or rubbing on sharp edges.

Do not clean the unit with a power washer.

This appliance is not approved for power washing.



The appliance generates significant amounts of heat and the operator should take care when touching accessible surfaces that are likely to get hot. Areas close to the cooking surface

including side panels may get hot enough to burn skin.

Do not attempt to service this appliance unless you are a factory authorized service technician as it will void your warranty.

This appliance is intended for commercial use only and should only be operated by fully trained and qualified personnel.

The electrical power supply must be disconnected prior to cleaning, maintenance or service.

Do not sit or stand on the appliance under any circumstance. Serious injury and damage to the operator, appliance and/or property could result.

Do not operate the appliance unless all panels and covers are installed.

Ensure that the unit does not contain food debris or is obstructed in any way. A clean cooking surface is imperative for proper operation.

Use only stainless steel, wood or plastic tools as supplied to scrape off heavy deposits or oil.

Do not use generic steel scrapers or knives, as iron particles may become embedded and rust.

NEVER USE STEEL WOOL.

The Grease Box should be emptied as required.

Do not allow it to overfill.

USE AND CARE, *continuation*

Do not cool off a hot broiler with ice. The use of ice may damage the castings, crack the welds, or warp the broiler grate castings which will void the warranty.

Once the unit has cooled, external stainless steel panels should be cleaned using a mild detergent and/or a food-safe liquid cleaner designed to clean stainless steel. If necessary to use a non-metallic scouring pad, always rub in the direction of the grain in the metal to prevent scratching. Wash a small area at a time and rinse the washed area with a clean sponge dipped into a disinfectant and wipe dry with a soft clean cloth before it can dry.

It is recommended to clean the control screen only with a damp soft cloth.

Use only stainless steel, wood or plastic tools to scrape off heavy deposits or oil. **Do not** use ordinary steel scrapers or knives, as iron particles may become embedded and rust. **NEVER USE STEEL WOOL.**

Rinse with clean water and wipe away residue with a clean, dry cloth.

The grease drawer should be emptied as required. **Do not** allow it to overflow.

Scrape the grease trough and chute, directing any grease/debris into the grease drawer. Once cool enough to handle, empty grease drawer, scraping out stubborn grease/debris and wash drawer in a hot soapy solution.

Service Maintenance

Any maintenance involving the disassembly of components should be performed by a factory authorized service technician as part of a regular kitchen maintenance program. Regular (at least 6 month intervals) inspection should be done to verify performance and make any necessary adjustments to the appliance. In addition, cleaning behind the front panel should also be done by a factory authorized service technician during regular maintenance.

Service and Parts

If for any reason this appliance requires service, contact The Garland Technical Service Department at 1-855-586-1542. All repairs must be performed by a qualified technician, using genuine Garland replacement parts or there will be a risk of voiding the warranty.

Refer to the rating plate found on the right exterior side of the unit, when calling for service. The plate contains the model and serial numbers for your appliance. Properly identifying the appliance will ensure the factory, or your local service agency provide faster and more accurate service.

CLEANING AND MAINTENANCE

IMPORTANT NOTE:

THIS APPLIANCE WILL WORK AT MAXIMUM PERFORMANCE AND LAST LONGER IF IT IS PROPERLY MAINTAINED. FOLLOWING A CLEANING SCHEDULE AND HAVING THE UNIT CHECKED AT LEAST ANNUALLY BY AN AUTHORIZED SERVICE AGENT ARE RECOMMENDED.

(Always check with Chick-fill-A store Manager for latest cleaning information)



IT IS THE USER'S RESPONSIBILITY TO PREVENT THE HAZARDS OF GREASE ACCUMULATION BY CLEANING AND MAINTAINING THE APPLIANCE ON A REGULAR BASIS. GARLAND WILL NOT BE RESPONSIBLE FOR DIMINISHED PERFORMANCE AND/OR DAMAGE, OR FIRES RESULTING FROM MISUSE AND/OR POOR CLEANING AND MAINTENANCE PROCEDURES.

Daily Cleaning (at the end of the day)



Warning: Always disconnect electrical power before cleaning accessible panels.



1. Press the **GREEN** button to raise upper platen; allow clamshell broiler to cool for approximately 20 minutes before cleaning.

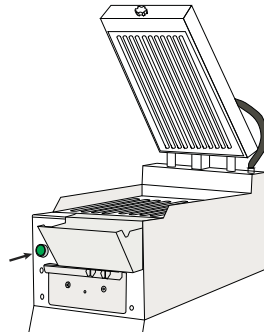

3. Remove oil/roller tray insert and discard canola oil left in the pan.
4. Disassemble oil roller by sliding roller off of handle.

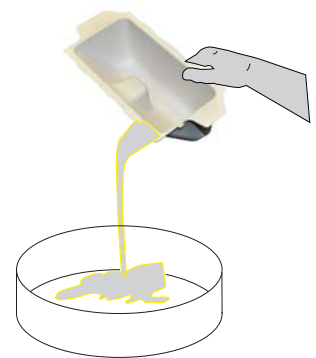

Eye protection or face shield must be used for the following steps.



2. Turn the clamshell broiler Main Power Switch OFF. (Green Main Power switches are set at the ON: "I" and OFF: "0" position)

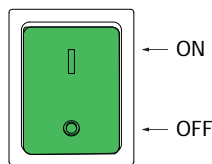

5. Take all cooking tools and holders to compartment sink to be washed.
6. Release upper broiler grate in order for surfaces behind grate to be cleaned.
 - With the broiler upper platen in the raised position, rest gloved hand in place to catch upper grate when it is released.

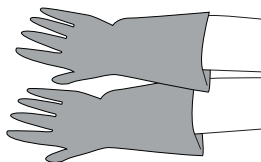
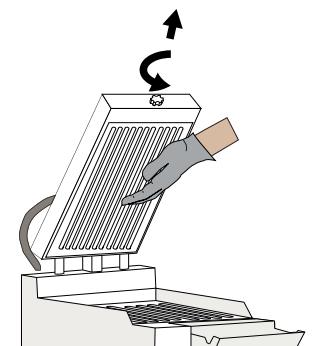

Protect your Hands
Wear Glove

- Turn knob counterclockwise until grate is released. This may require 5 or more turns to unlatch

CLEANING AND MAINTENANCE, *continuation*

7. Remove upper grease shield out of the broiler lid. Wash, rinse, sanitize, and air dry until compartment is dry.

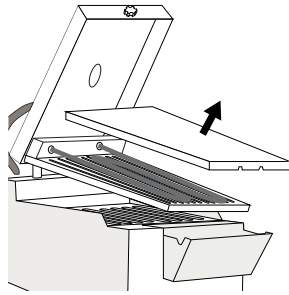

8. Wipe surface with damp towel, until clean. Use detailing tool if excessive carbon buildup is present.

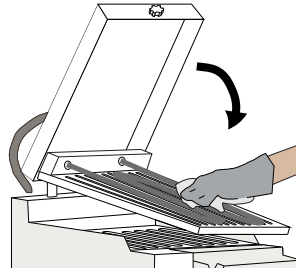

9. Clean areas not accessible during daily broiler cleaning. Wipe inside of stainless steel edges around broiler grate.

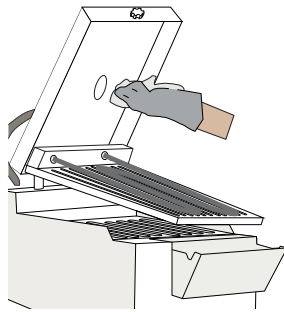

10. Clean areas at the far end of the broiler grate assembly. Wipe clean with a damp cloth all the grease accumulated in that area as illustrated above.

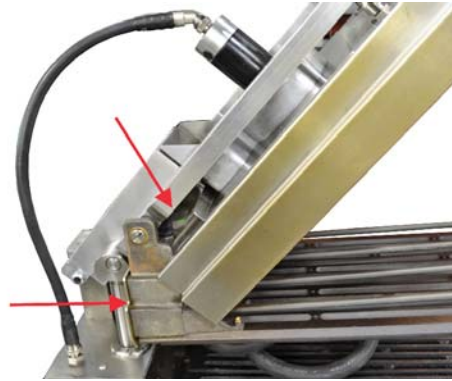

11. Wipe the hinges and surrounding areas between the cowl assembly and the grate until clean, with a damp cloth as shown above. Avoid catching fingers in the mechanism.

12. Brush upper heating elements and areas of heavy build-up using broiler brush.

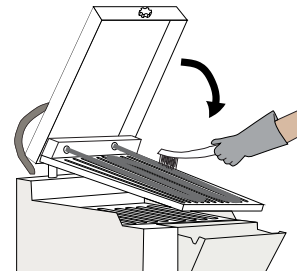

13. Replace upper grease shield and return upper broiler grate to position.

- Raise grate to just below lid or cowl.
- Pull knob out to allow grate to slide into place.
- Continue supporting weight of grate until knob is completely tightened.

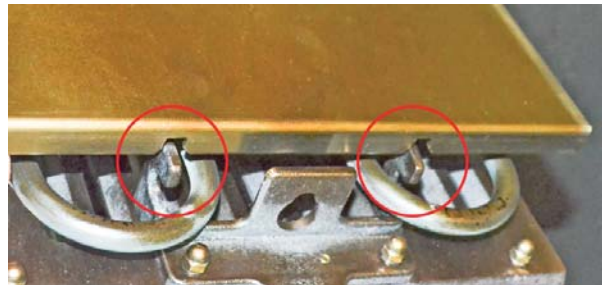
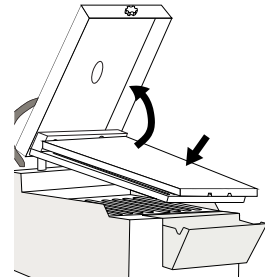

Note: Ensure that the upper grease shield is in the right place aligning the two notches as shown above.

CLEANING AND MAINTENANCE, *continuation*

14. Tighten knob completely, until bracket touches the cowl assembly, but do not over-tighten. Ensure broiler grate is tight up to the cowl assembly. The grate should be parallel to the cowl assembly.

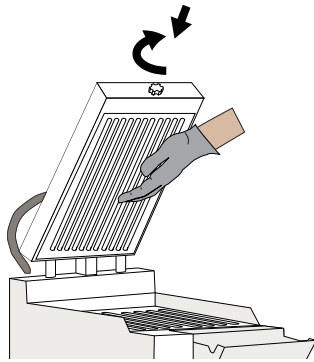

(see previous latching instructions)

15. Brush upper broiler grate with broiler brush, from front to back, to push debris towards the back of broiler.

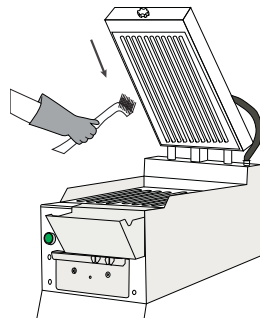

16. Brush the lower broiler grates with broiler brush. Brush from front to back.

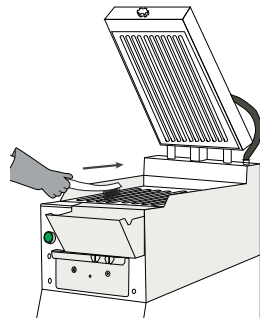

17. Use detailing tool to raise each half of lower grate.

Careful not to drop grates while they are raised.

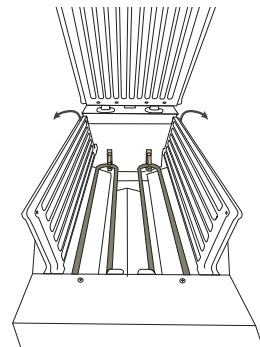

18. Scrape grate surfaces that are now exposed, first with tooth side of detailing tool, then with smooth side. Brush heating elements and area of heavy build-up using broiler brush.

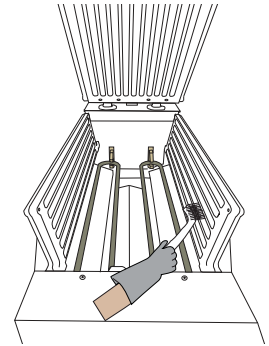

19. Use detailing tool to lower grate halves back into a lower position.

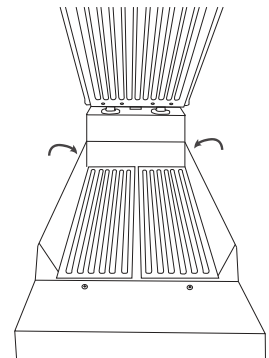

20. Remove skirt on each side of lower broiler. Lift each one straight up from the sides, then tilt until skirt is clear of broiler.

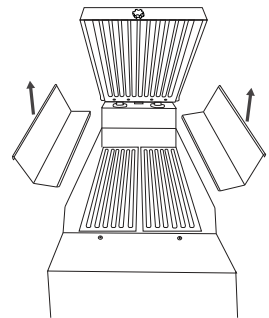

Important Note: Be careful not to get Kay QSR super contact cleaner on the grates.

21. Use Kay QSR super contact cleaner to clean stainless steel edges around upper and lower grates.
- Wring out a clean, sanitized towel and spray with Kay QSR super contact cleaner.

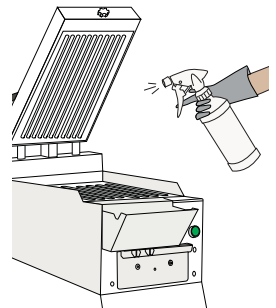

CLEANING AND MAINTENANCE, *continuation*

- Turn towel over and wipe surface again to remove excess cleaner.

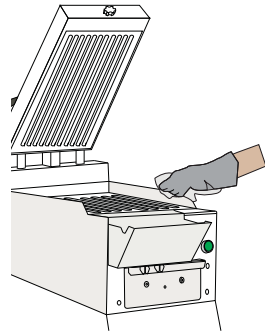

Important Note: Roller brushes should be cleaned daily and discarded at the end of the week.

Tip: Cleaning Instructions are guidelines. Clean more frequently if needed.

- 25. Discard used oil roller pads. New ones should be used when assembling oil roller for the next day.



CAREFUL!
CRUMBS COULD STILL BE WARM.
BE AWARE; CRUMBS MUST BE COOL BEFORE DISCARDING IN TRASH CAN

- 22. Slide out grease drawer.
- Remove crumb baffle.
- Scrape crumbs from baffle and grease drawer with metal spatula and discard in trash can.

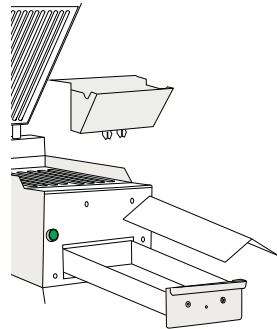

- 26. Wash, rinse, sanitizer and air-dry crumb baffle, grease drawer, detailing tool, broiler brush, nugget screen, lower broiler skirts, oil/roller tray, roller pan, oil roller and handle.

- Wash, rinse, sanitize and air-dry all parts in kitchen sink.
- Replace all parts after cleaning.

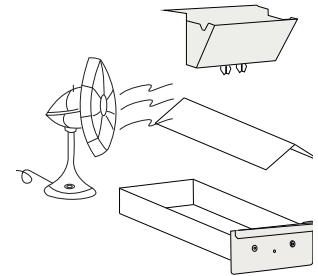

- 23. Rinse crumb baffle, grease drawer and detailing tool with sprayer at the kitchen sink.
- Remove grease drawer and empty.
- Clean grease drawer, crumb baffle and scraper with hot water.

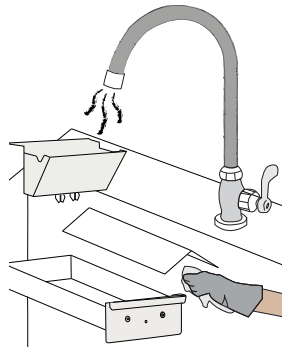

- 27. Clean all exterior broiler surfaces
- Wring out a clean, sanitized towel well and spray with degreaser solution.
- Wipe all exterior surfaces.
- Turn towel over and wipe surface again to remove excess degreaser.

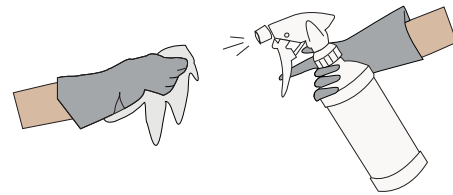

- 24. Remove any remaining carbon build-up with metal spatula
- Clean brush tool with hot water at the compartment sink.

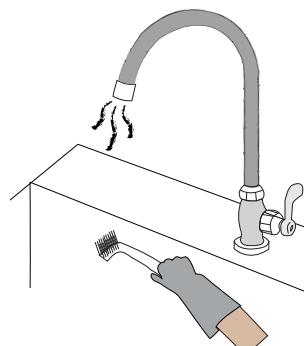

- 28. Sanitize all exterior broiler surface
- Wring out a clean, sanitized towel well and spray with sanitizer.
- Wipe all exterior surfaces.
- Leave sanitizer on surfaces for at least 15 seconds to kill any remaining bacteria.
- Turn towel over and wipe surface again to remove excess sanitizer.
- Clean the control screen only with a damp soft cloth.

CLEANING AND MAINTENANCE, continuation

29. Reinstall parts removed for cleaning, after they have air-dried.

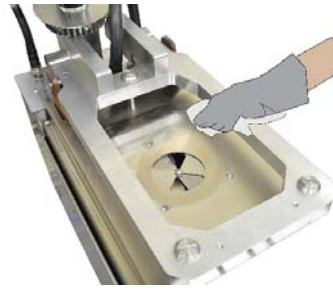
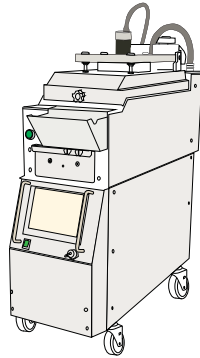

33. Remove exhaust tray, wring out a clean, sanitized towel and spray with degreaser solution. Turn towel over and wipe surface to remove grease.

30. Press the **GREEN** button to lower upper platen; Turn the clamshell broiler Main Power Switch OFF (Green Main Power switches are set at the OFF: "0" position).

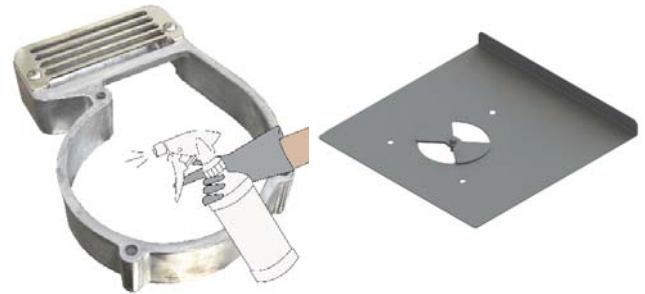
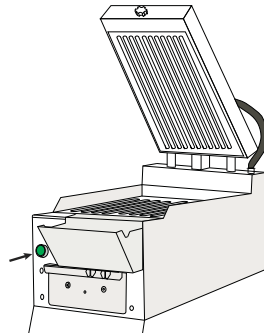

34. Spray the exhaust tray and housing with degreaser solution. They can be cleaned in the sink to remove grease/debris.

BE GENTLE WITH ELECTRICAL CONDUIT

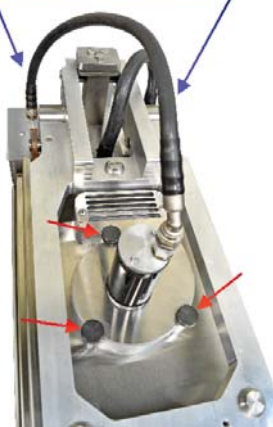

31. Remove the three (3) thumb screws located around the motor.

Important: Be gentle with the electrical conduit when removing motor, electrical conduit is not designed to be disconnected. Do not attempt to disconnect the motor conduit.



35. Place exhaust tray, housing & motor in place and tighten the (3) thumb screws manually by hand.

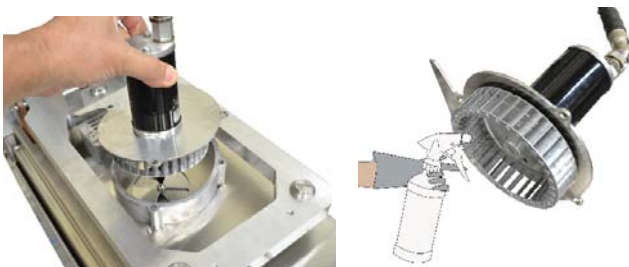

32. Lift up the motor, and spray blower wheel with degreaser solution. It is recommended to perform cleaning over a towel/rug/paper for easy disposal of the falling debris. Rest the upper blower assembly safe with all other parts are cleaned and returned.

CHICKEN PRODUCT PLACEMENT

(Always check with Chick-fill-A store Manager for latest cooking methods)

This procedure is used to cook marinated chargrilled filets, unmarinated Chick-fil-A filets and Grilled Nuggets on the Garland clamshell broiler.

Before you begin loading chicken, be sure to...

- ✓ Verify that chicken has been thawed (35°-40°F / 1.7° - 4.4°C). Chicken that is not completely thawed will not cook properly and may not reach the internal product temperature required to kill bacteria (165°F / 74°C).
- ✓ Verify that enough chicken for current batch has been fileted.
- ✓ Verify remaining shelf life and quality of chicken. Notify your Supervisor or Operator if any chicken has passed its expiration date.
- ✓ Keep chicken refrigerated until immediately before grilling so it will maintain an internal product temperature of 40°F / 4.4°C or lower.
- ✓ To avoid flavor transfer, use separate yellow trays for transferring chargrilled filets and Nuggets/ Chick-fil-A filets to broiler.
- ✓ Store yellow tray (and yellow-handed tongs, if used) in refrigerator when not in use to help prevent bacterial growth.

Ingredients	Quantities
Raw filets (chargrilled or Chick-fil-A filets)	Up to 10 per batch
Raw Nuggets	Up to 40 per batch

Equipment/Items	Used For
Yellow food service gloves	Handling raw chicken
Yellow apron	Working with raw chicken
Designated yellow trays	Transferring raw chargrilled filets to broiler Transferring raw Nuggets/ Chick-fil-A filets to broiler

1. Remove chicken from refrigerator and place it on designated yellow tray.
2. Notify Boards person that filets are ready for cooking. This will alert Boards person to prepare broiler.

3. Load raw chicken onto broiler.

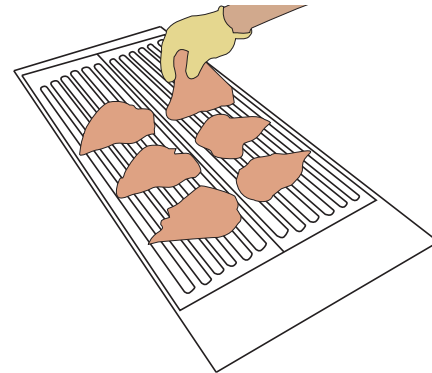

• **Fillet:**

- Ensure that oil has been applied to lower and upper broiler grates.
- Load up to 10 filets on broiler (5 rows of 2 filets), working from front to back.
- Position filets so they are centered on left half or right half of lower broiler grate (not overlapping outer or inner edges of broiler grate).

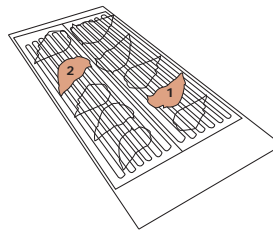

Load of 2 filets

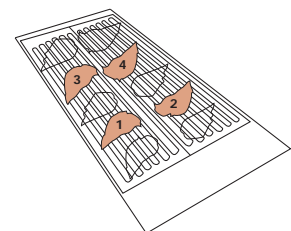

Load of 4 filets

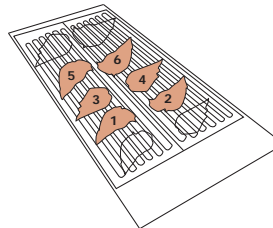

Load of 6 filets

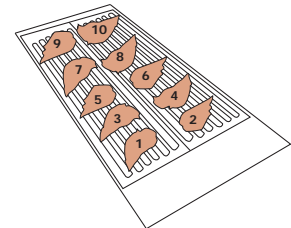

Load of 10 filets

- Place filets with smooth side down because best broiler marks will show on smooth side.
- Point tips of filets to outside of broiler, so that thickest portion of filet is in center of broiler.
- Make sure filets do not touch.

CHICKEN / NUGGETS PRODUCT PLACEMENT

- **Nuggets:**

- Ensure that Nugget screen is in place on lower broiler grate and that oil has been applied to screen and upper broiler grate.

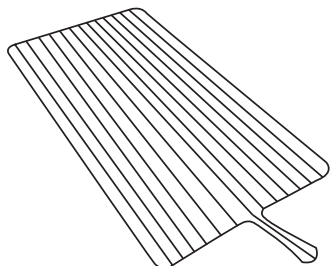

- Load up to 40 Nuggets starting at front of broiler; spread Nuggets out evenly on Nugget screen.
- Keep Nuggets at least 1/2" from edge of broiler.
- Make sure Nuggets do not touch. Nuggets that touch will stick together and will not cook properly.

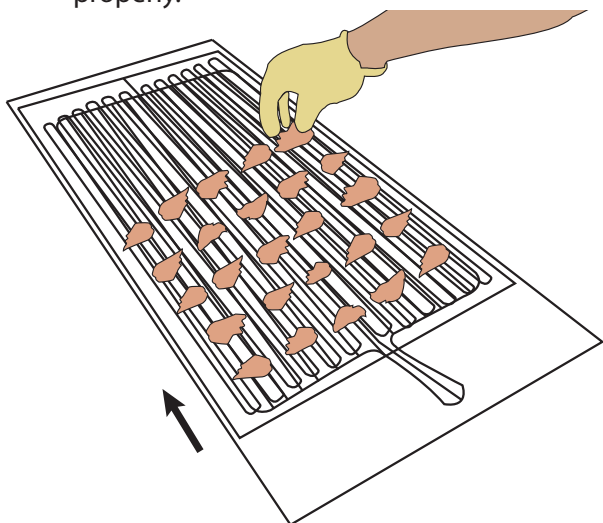

CAUTION: If broiler sounds warning tone while loading product, step back from broiler immediately to avoid risk of being burned when broiler lid closes. If this happens, ask Boards person to reset timer.

To avoid cross-contamination, never touch broiler without first removing yellow gloves and washing and sanitizing hands.

Cook only the amount of chicken that will be served within 30 minutes. Never cook more than designated amount at a time.

Do not use butter-flavored oil to coat broiler grates

4. Notify Boards person that chicken is loaded and ready to be cooked.
5. Remove raw chicken transfer pans (and any utensils used) from Boards area while Boards person lowers broiler lid.
6. Refrigerate transfer pans (and any utensils used) to minimize risk of bacterial growth.
7. Clean and sanitize yellow tray (and any utensils used) every 4 hours.
 - Take items to sink after 4 hours of use.
 - Wash, rinse, sanitize and air-dry. This breaks bacterial growth cycle and reduces food safety risks.

BACON / SAUSAGE PRODUCT PLACEMENT

(Always check with Chick-fill-A store Manager for latest cooking methods)

Before you begin cooking bacon or sausage, be sure to:

- ✓ Verify that broiler is clean. If any burned food particles or carbon build-up appear on upper or lower broiler grates, clean them with broiler brush. (See Garland Broiler: Cleaning Garland Broiler after Each Batch).
- ✓ Verify that Duke holding station has been pre-heated, that compartment for holding sausage (SAUS) has a black, solid lid (SOLD) and that compartment for holding bacon (BACN) has a gray, vented lid (VENT).

Ingredients	Quantities
Bacon half-slices	Up to 30 per batch
Sausage patties	Up to 10 per batch

Equipment/Items	Used For
Used For Clear food service gloves or metal-handled tongs	Placing bacon or sausage on broiler
Food film	Wrapping unused bacon or sausage
Dated and labeled stickers	Monitoring shelf life
Metal spatula or metal-handled tongs	Removing cooked bacon or sausage from broiler
Duke holding pan	Holding bacon or sausage

1. Remove thawed bacon or sausage from refrigerator. Cook only amount that will be used within 30 minutes.
2. Press PRESS & GO icon to bring broiler out of standby mode, if needed. Display will show available products to be cooked on the broiler.

It is NOT necessary to coat broiler grates with oil when cooking bacon or sausage.

CAUTION: To save energy, broiler will automatically close and enter sleep mode unless a cooking cycle is started within 3 minutes from end of previous cooking cycle.

- Load bacon or sausage as soon as broiler is ready.
- If unexpectedly delayed so that you are not able

to finish loading product within 3 minutes, press ABORT icon to reset 3-minute timer

3. Load bacon or sausage on broiler.

• **Bacon:**

- Load up to 30 half-slices of bacon on broiler, working from front to back. Position slices horizontally on broiler grates.

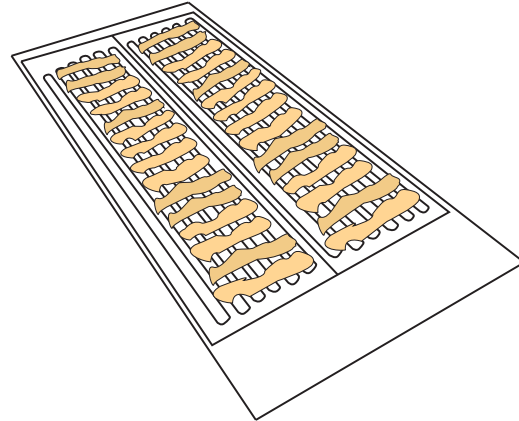

- Position bacon half-strips so they are on left half or right half of lower broiler grate (not overlapping outer or inner edges of broiler grate).
- Make sure bacon half-strips do not touch.

• **Sausage:**

- Load up to 10 sausage patties (5 rows of 2 patties), working from front to back.

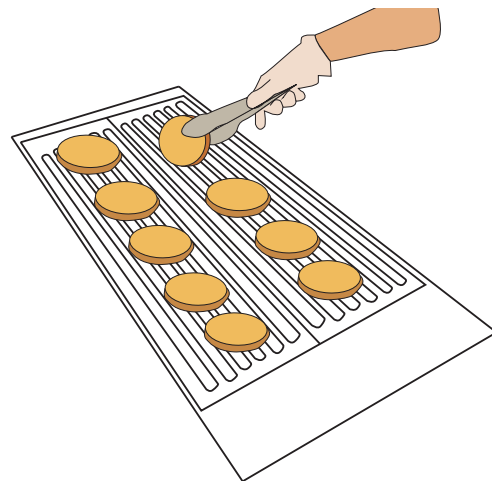

- Position sausage so that patties are centered on left half or right half of lower broiler grate (not overlapping outer or inner edges of broiler grate).
- Make sure sausage patties do not touch.

CAUTION: If broiler sounds warning tone while loading product, step away from broiler immediately to avoid risk of being burned when broiler lid closes. Then reset timer.

Do not use butter-flavored oil to coat broiler grates

4. Start cooking cycle.
 - Press appropriate product icon.
 - Press START button to close lid immediately.
 - Broiler display will identify product being cooked (BACON or SAUSAGE) and remaining cook time.
 - It is important to press correct product icon because broiler has individual settings for each product.
 - If wrong product icon is pressed, the product selection can be changed within first 30 seconds of cook cycle.
 - Press and release ABORT icon.
 - Press correct PRODUCT icon.
 - Press START icon.
 - After 30 seconds, if cook cycle is stopped the product must be discarded because it will not be completely cooked
5. Return unused bacon or sausage to refrigerator.

At end of day, wrap unused bacon in food film to help prevent flavor transfer. Make sure dated and labeled sticker is attached; sticker must reflect date package was opened.

SHELF LIFE for bacon (40°F or lower), from time package is opened until bacon is cooked, is 7 days.

SHELF LIFE for sausage (40°F or lower), from time thawed until cooked, is 7 days

6. Verify that bacon holding pan or sausage holding pan will be empty before new batch finishes cooking.

7. Press Start icon (✓) when beeper sounds. (When cooking cycle is complete, broiler lid will open automatically and REMOVE will show on display. Timer will continue to beep until icon is pressed).
8. Inspect color of cooked bacon or sausage, using Test Quality Photos as guideline.

If sausage or bacon fails to match color requirements in Test Quality Photos, cook batch for an additional 45 seconds, by pressing the (0:45) icon. Lid will close during additional cooking time.

9. Transfer bacon or sausage to holding pan with metal spatula. Spread product out in holding pan so it will not touch lid.
10. Hold bacon or sausage according to current procedure. (See Boards–Breakfast: Bacon and Sausage).

HOLDING TIME for cooked bacon or sausage (140°F or higher), from time cooked until served, should not exceed 30 minutes.

11. Clean broiler surfaces with broiler brush after each batch. (See Garland Broiler: Cleaning Garland Broiler after Each Batch).
12. Press SLEEP icon (moon icon) to lower broiler lid if next batch will not be cooked immediately.

DESCRIPTION OF CLAMSHELL BROILER CONTROL

easyToUCH™ HOME & RECIPE SELECTOR PAGES

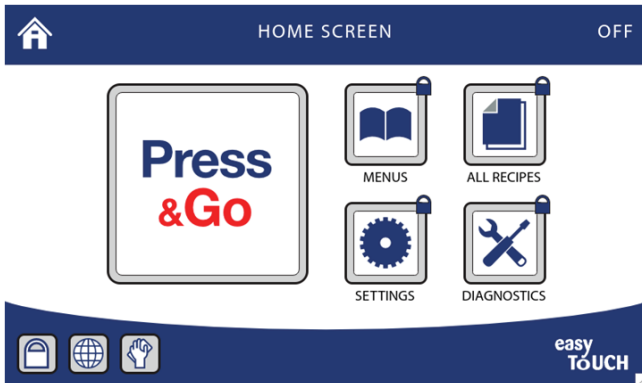

PRESS & GO - Used to access the preheat and cooking modes of the broiler.



MENUS - Used to add, edit, and delete Menus from the library. A Menu is a collection of cook recipes. Password protected.



SETTING - Used to change certain settings, such as date, time, and volume. Password protected.



RECIPES - Used to add, edit, and delete Recipes from the library. A Recipe consists of the cooking times, temperatures, and platen gaps for preparing a food item. Password protected.



DIAGNOSTICS - Select to view diagnostics screens. Password protected.



CLEAN MODE - Used to put the broiler into Clean mode. When the broiler is set to enforce the cleaning schedule, using the Clean Mode resets the cleaning counter



COOK CYCLE CHANGE - Used to adjust a recipe's cook time or platen gap, if required to achieve food safety and quality standards



LOCK - Used to temporarily lock the touch screen. Locks the touch screen for six (6) seconds to prevent accidental key presses when wiping the screen



LANGUAGE - Used to change the language of on-screen prompts. Only available if other languages have been pre-loaded on the broiler.



HOME - Returns to the Home screen, the launching point for Cooking and programming modes. When the home screen is showing, the heaters are off.



TEMPERATURE - Used to view the temperature settings and actual temperature in each zone.



SLEEP - Used to enter sleep mode. In Sleep mode, the platen lowers to conserve energy while the broiler is inactive

easyToUCH™ OVERVIEW

Clamshell Broiler Operating Modes:

The Clamshell Broiler operates in several modes accessible using the easyToUCH™ screen. All modes except for Sleep are selected from the Home screen. Clean mode may be selected from the Home screen or from Press & Go (cook) mode.

Press & Go mode is used to select menus, preheat the broiler, and cook recipes. The broiler will not preheat unless Press & Go has been selected. If multiple menus have been set up, select the appropriate menu to ensure the broiler preheats to the correct temperature.

The recipes stored by the broiler contain the cooking profiles (times, temperatures, and platen gaps) for various products.

If multiple menus have been set up, each may contain different recipes. To change the menu, select the "Menu" button at the top of the easyToUCH™ screen.

Sleep mode lowers the platen to conserve energy while the broiler is not in use while keeping it ready to start a cook cycle. The broiler may be configured to enter Sleep mode automatically after a period of inactivity, depending on the set up.

To enter Sleep mode manually, press the Sleep icon. The upper grate will lower, and the broiler will maintain the set temperatures.

To exit Sleep mode, select WAKE on the easyToUCH™ screen or press the GREEN pushbutton. The upper grate will rise and the broiler is ready to cook.

To stop the broiler from automatically entering Sleep mode, elect the red 'X' on the easyToUCH™ screen or press the GREEN pushbutton. The upper grate will rise and the broiler is ready to cook.

Clean mode has two functions: it resets the cleaning counter and brings the broiler to the appropriate temperature for cleaning.

By putting the broiler into Clean mode before cleaning the broiler, the cleaning reminder is reset to zero and the "Cleaning Reminder" prompts are suppressed. If the cleaning schedule is enforced, at some point the broiler must enter Clean mode before cooking may resume.

If a cleaning temperature has been set, Clean mode will bring the broiler to the set temperature prior to starting the cycle. (A cleaning temperature may be specified if required by the cleaning procedure or cleaning chemicals.)

OTHER easyToUCH™ SCREENS

Cook Cycle Changes:

To ensure a quality product, the cook time and platen gap of a recipe may be changed prior to starting the cook cycle. Using the Cook Cycle Change screen, time can be added or subtracted from the end of a recipe and the platen gap can be opened or closed.



To change the cook cycle, select a recipe then press the "+" icon. The Cook Cycle Change screen appears. Using the up and down arrows, the time and the cook gap can be adjusted within certain limits. The changes will apply until the power is turned off.

Changes to a recipe can also be cleared by pressing the "C" button on the Cook Cycle Change screen.

When a recipe has been changed, the recipe will have a "+" indicator on the Recipe Selector screen, and the cooking progress screen will show the adjustments to the recipe.



easyToUCH™ OVERVIEW, continuation

Temperatures:

The temperature screen shows the actual and the set point temperatures at each thermocouple, and whether that zone is heating or at temperature.



The temperature screen can be displayed by pressing the icon in the top right corner when cooking, cleaning, sleeping, or preheating. Press the Back arrow or Check mark to return to the previous screen.



Warnings and Alerts:

Too Cool/Too Hot - If the broiler temperature is too cool to properly cook a recipe, a Too Cool to Cook message appears. The broiler will not allow the cook cycle to start until it has heated to the minimum required starting temperature.



TOO COLD TO COOK!

Similarly, if the broiler is too hot, a Too Hot to Cook message is displayed while the broiler cools.



TOO HOT TO COOK!

In either case, another recipe can be selected while waiting. If the broiler is at the right temperature to cook the newly selected recipe, cooking can start immediately.

Grates Open:

- For safety, an interlock switch cuts power to the heaters when the grates are open for routine cleaning. A warning message is displayed until the grates are returned to the operating position.



HIGH VOLTAGE NOT PRESENT
CHECK LOWER GRATES ARE NOT OPEN

Note - if the main power is switched off, the power is already cut to the heater and easyToUCH™ screen, and the message does not appear.

Shutdown:

Press the Home icon to exit Press & Go mode and turn off the heaters.

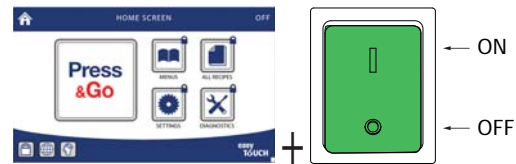

Fully power off the broiler and the easyToUCH™ screen using the main power switch.

Cleaning Reminders:

If a cleaning schedule has been set, a message will appear on the screen when cleaning is required based on the number of cook cycles. Select the tick mark if the broiler will be cleaned immediately, or "X" to continue cooking.

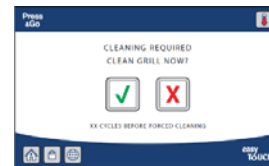



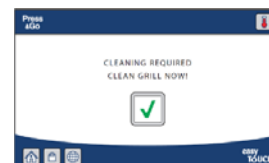



If the broiler is set to enforce cleaning schedule and the cleaning reminder has been bypassed too many times, easyToUCH™ eventually displays the Cleaning Required screen (p. 32 from the wireframes).

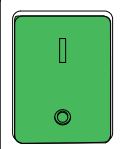
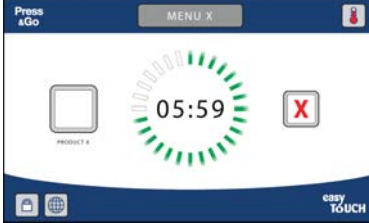
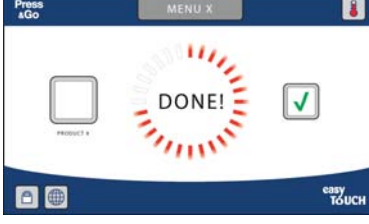

easyToUCH™ OVERVIEW, continuation

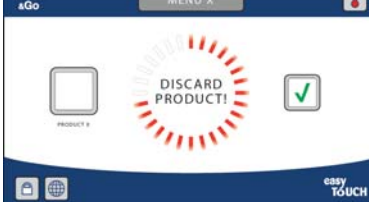
START UP COOKING:

The easyToUCH™ screen display, layout and icons shown herein are for guidance purposes only and are not intended to be an exact representation of those displayed on the broiler.

	<p>1. Switch the broiler on using the main power switch.</p>		<p>7. Cooking time.</p>
<p>2. The easyToUCH™ screen illuminates with the display briefly showing the software version (white text on black background).</p>			<p>8. Cooking Done.</p>
	<p>3. When the Home screen appears, select Press & Go (Do not hit Press & Go until platen completes its homing sequence).</p>		<p>9. Discard product.</p>
<p>4. The broiler will start preheating using the temperatures from the selected menu and the preheat progress will be displayed.</p>			<p>10. Back to product selection.</p>
	<p>5. Following preheat the broiler enters a soak period, allowing the temperature to stabilize throughout the upper and lower grates.</p>		
	<p>6. The broiler is ready to use when the Recipe Selector/ Ready to Cook screen is displayed..</p>		

easyToUCH™ OVERVIEW, continuation

COOKING A RECIPE:

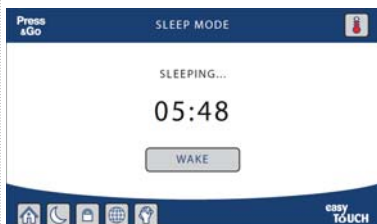

1. If the broiler has entered Sleep mode, select WAKE to raise the platen.



2. Select the recipe to cook.

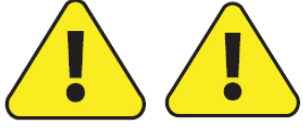

3. If the broiler is at the wrong temperature for the item selected, a "Too Hot" or "Too Cool" warning will appear.



Wait for the broiler to reach temperature or select a different recipe.

4. Lay product on the grates using the appropriate placement guidelines. For more detail see "CHICKEN / NUGGETS PRODUCT PLACEMENT" on page 42



5. Press START or the GREEN push button to close the platen. Start the cycle. A progress ring and countdown timer is displayed.



6. Start the cycle. A progress ring and countdown timer is displayed.



Note: Touching the red "X" or pushing the green button during cooking stops the cook cycle, raises the platen, and displays a warning.



7. When the cook cycle has finished a "DONE" message is displayed, usually with an audible alarm. Remove the product and touch the green tick mark or press the green button to acknowledge the "DONE" message.





Note: If the wrong recipe was selected, the recipe can be changed by stopping the cook cycle, acknowledging the warning, selecting the correct recipe, and pressing START or the GREEN push button again. Changes should be made within thirty (30) seconds to avoid overcooking the product.











SAUSAGE or BACON: After a cook cycle has ended, if the cooked product fails to match the color requirements in the Test Quality Photos, cook the batch for an additional 45 seconds, by pressing the (+45 sec) icon. The platen will close and the product will cook for the additional time.

easyTOUCH™ OVERVIEW, continuation

CHANGES TO A RECIPE COOK CYCLE:

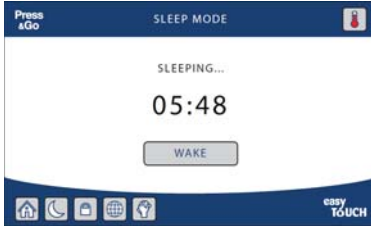





	<p>1. Follow step from 1 to 6 from previous Press & Go.</p>		<p>3. Clamshell broiler will make the necessary adjustments.</p>
	<p>2. Make the necessary adjustments and save.</p>		<p>4. Ready to cook product.</p>

SLEEP MODE:

	<p>1. Press & Go, (press)</p>		<p>4. Top platen will close, make sure no utensils on broiler.</p>
	<p>2. Press  icon.</p>		<p>5. Monitor will show sleeping time. Press touch the wake option to start.</p>
	<p>3. Press touch check mark  to continue or X  to cancel.</p>		

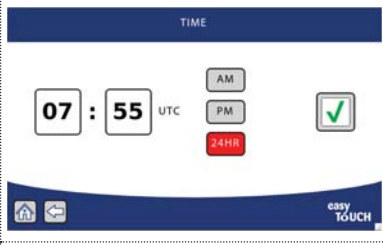
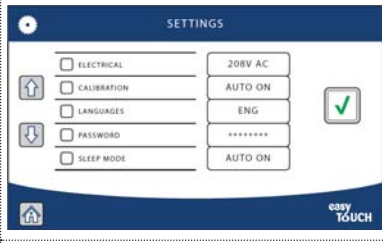
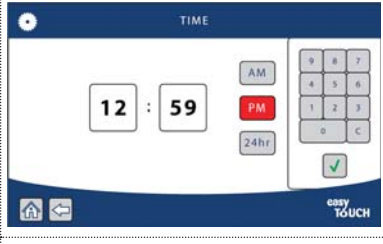
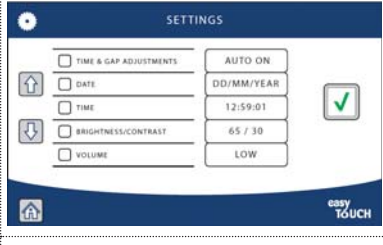
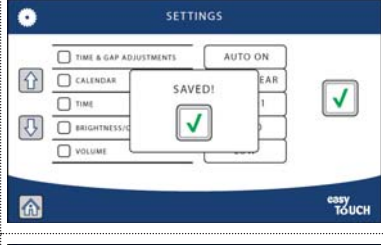





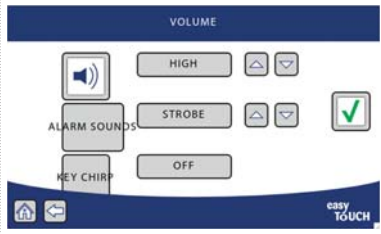

easyToUCH™ OVERVIEW, continuation

SETTINGS MODE:

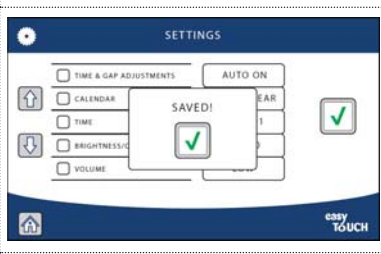
	<p>1. Select "SETTINGS".</p>		<p>7. Select <input checked="" type="checkbox"/> to save date choose.</p>
	<p>2. Enter password (alphabet).</p>		<p>8. Time option selected (display shown).</p>
	<p>3. Display of settings shown.</p>		<p>9. Numeric pad will appear as touch.</p>
	<p>4. Display of settings shown.</p>		<p>10. Select <input checked="" type="checkbox"/> to save Time.</p>
	<p>5. Display of settings shown.</p>		<p>11. Languages option selected (display shown).</p>
	<p>6. Date option selected (display shown).</p>		<p>12. Select language.</p>

easyTOUCH™ OVERVIEW, continuation

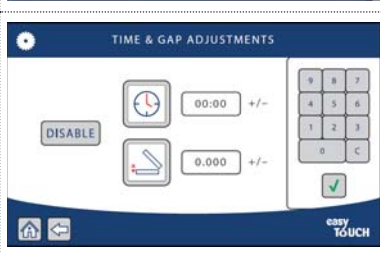
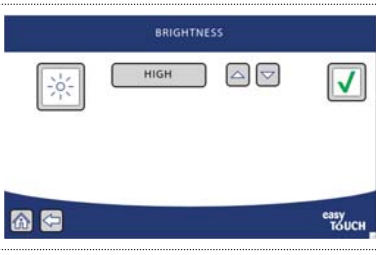
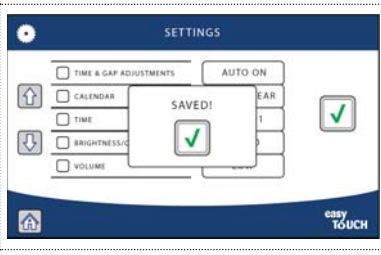
SETTINGS MODE: continuation

	<p>13. Select <input checked="" type="checkbox"/> to save language.</p>		<p>19. Volume option selected (display shown).</p>
	<p>14. Password option selected (display shown).</p>		<p>20. Select <input checked="" type="checkbox"/> to save Volume.</p>
	<p>15. Type new password.</p>		<p>21. Time & Gap Adjustments option selected (display shown).</p>
	<p>16. Select <input checked="" type="checkbox"/> to save password.</p>		<p>22. Numeric pad will appear as touch. Enter new settings.</p>
	<p>17. Brightness/contrast option selected (display shown). Make necessary adjustments.</p>		<p>23. Select <input checked="" type="checkbox"/> to save Time & Gap Adjustments.</p>
	<p>18. Select <input checked="" type="checkbox"/> to save Brightness/contrast.</p>		

INSTRUCTION FOR SOFTWARE UPDATE

Garland will notify FAS's of new software drop. FAS's are required to have clean (formatted) flashdrives with a minimum size of 8Gb. If the file received is compressed (zip), it needs to be decompressed and content (could be approx. 24 files) should be copied to a clean flashdrive. Flashdrive brands must be Kingston, Lexar or Sandisk (these brands have a faster transfer speed).

After a complete transfer of all files and before removing the flashdrive from the personal computer (laptop/desktop), ensure they flashdrive is properly ejected.

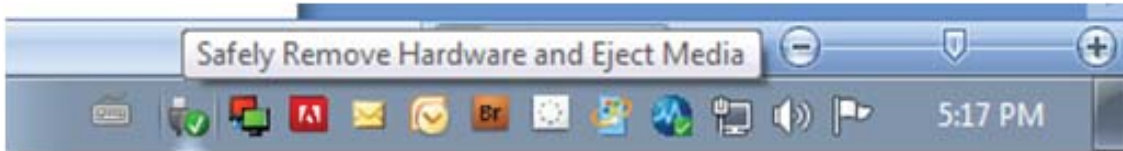



The update is done through the settings screen:

1. Turn ON the broiler and wait until it gets to the Home Screen. (If not at the Home screen or in Settings, press Home icon).

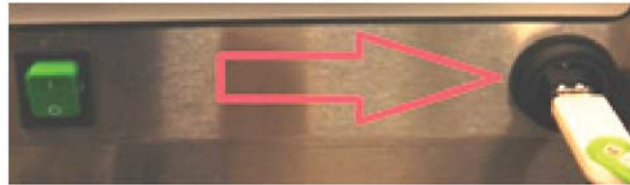

2. Insert flashdrive into USB port on the front panel of the broiler.



3. Press Settings  and enter the password provided.

4. Scroll through Settings to Calibration. Wait for the platen to move down and settle at the home switch. Write down the "Current Platen Position" number indicated in the photo below. Exit Calibration by pressing ←LEFT arrow.

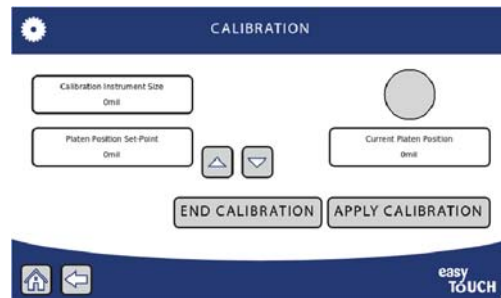

INSTRUCTION FOR SOFTWARE UPDATE, *continuation*

5. Scroll through Settings to Software Update. Press START UPDATE or UPDATE HRCB (older versions).



If the screen shows the HRCB error continue with the steps below, otherwise continue with step 6.



In Settings scroll down to USB Operations then press USB START.



Computer will search for USB if successful display will go back to COLLECT LOG



If search for USB unsuccessful – screen will state “Couldn’t find USB drive”. Try a different USB flash-drive and repeat number 5.

If USB was found successfully, start again from number 5.

6. The upgrade may take up to 10 minutes. Be patient and DO NOT remove the flashdrive.

The screen will turn black with white text. The text will change as the files are copied from the FlashDrive. The screen may appear frozen as the first couple of files take a few minutes. Soon, the screen will advance as more files are loaded. After the last file is processed, the screen will say ‘rebooting’ and automatically proceed to turn off and restart. **It may reboot twice** as the software may need to update of the SIB (Smart Interface Board) as well. This is normal.

INSTRUCTION FOR SOFTWARE UPDATE, *continuation*

```
Running /mnt/usbdrv/stinger.sib.installer.sh.
status=0
Running /mnt/usbdrv/stinger.sdk.installer.sh.
```

During the restart, check that the software version is the expected revision, v1.2.0. (In this example the software is at version 0.7). The software version can also be verified in Diagnostics.

```
Software Version:
GUI: v0.7
CLA: v0.0.7 kirk 20130704-11:27:27 r3274
Configuring audio.
Configuring system monitor.
Log collector.
Updating SIB FM if required.
SIB FM is up-to-date.
starting CLA.
starting GUI.
```



- Only remove the FlashDrive when the Home screen comes up. This is your indication that the software update is complete. Tag the flashdrive by writing the S/N of the broiler.



- Press Settings, select "SUPER USER" and enter the password provided. Scroll through Settings to Calibration. (Refer to #4) Wait for the platen to move down and settle at the home switch. Verify that the "Current Platen Position" is the same as the one recorded before the update. If the number is not within +/- 2, a gap calibration will be required. Return to Settings.



INSTRUCTION FOR SOFTWARE UPDATE, *continuation*

9. From Settings scroll to Volume and confirm it is set to HIGH. Use the Up arrow key to confirm that the speaker is working. Return to Settings.

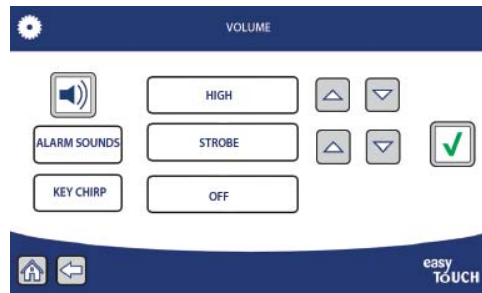

10. From Settings scroll to Sleep Settings and confirm the Auto Sleep? is YES. Set the Auto Sleep Delay to 300 sec. Select the check mark icon to save the changes.

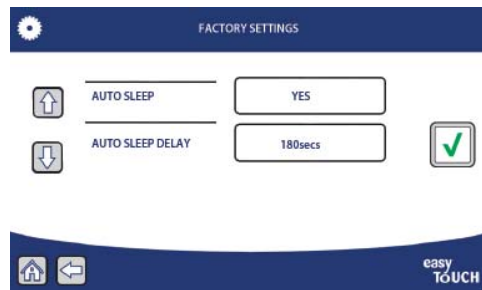

11. The software update and menu check is completed here. The platen will stay close.
 12. Go to Settings and then Hood Height Calibration to set to 3700.

Additional steps will be communicated by Garland as required.

LOGIC MENU TREE

(Subject to change)

Settings - Version 1.3.0 (Production Software Release - October 11, 2013)

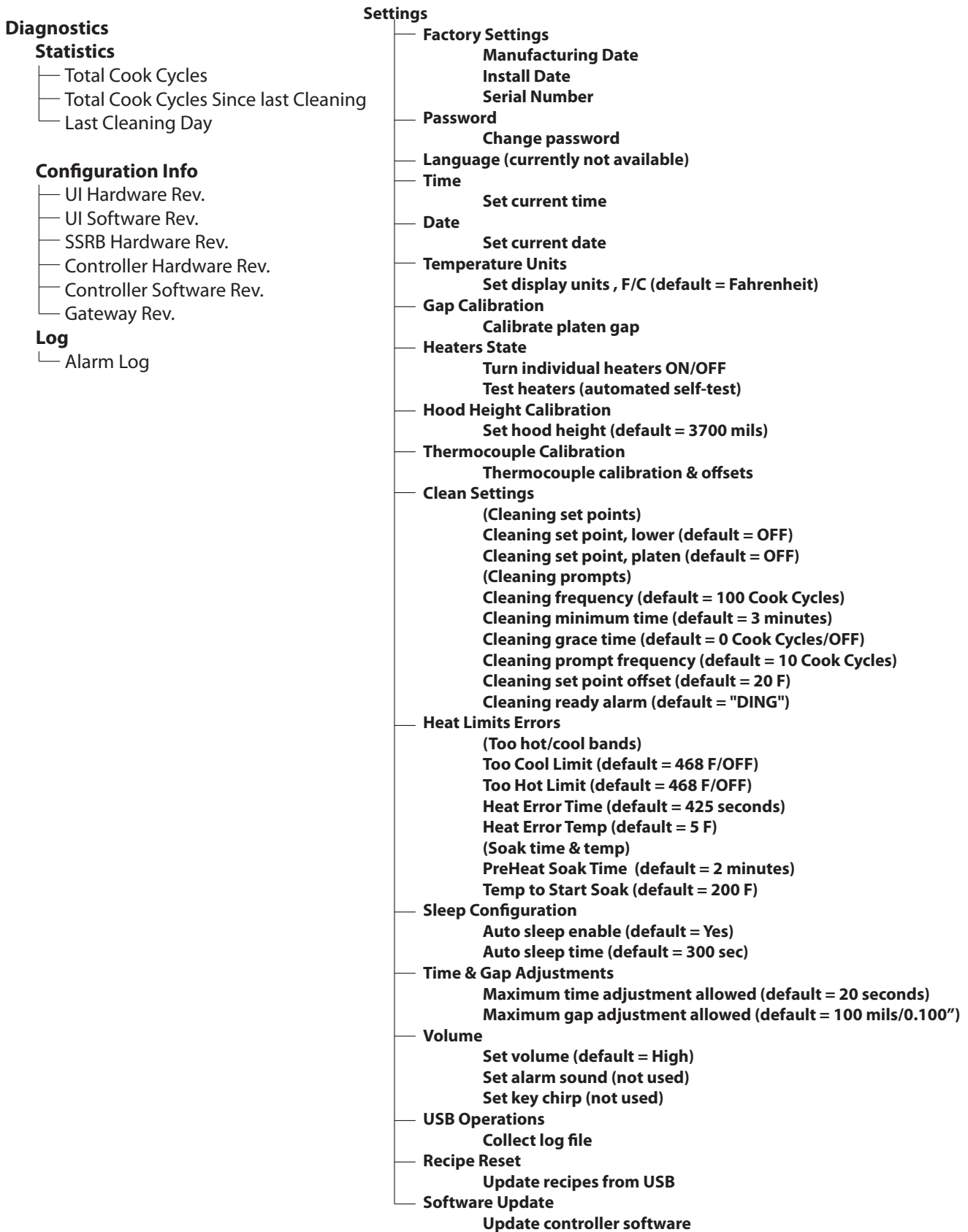

DIAGNOSTICS EVENTS LIST

"Event" Index"	Event Suffix (if Applicable)	Event Group	Event Description	Event Cause	State	Error generation criteria	Machine Action
1		Motion	Position Reference Error	Motor Control board has detected missed or extra encoder counts in referencing its location to the LRS	Entering cooking	When on lower switch if encoder is off (platen would be 5 mils too high, 20 too low)	"Reverse and move to Hood Height position if possible; Heaters: ALL are OFF Wait for operator input"
2	U	Motion	Motor Over-current Hardware Error	Motor Control Board has reported an over-current detection while the platen had been moving upward.	Any	Hitting 13A limit	"Stop motion - Heaters: ALL are OFF Wait for operator input"
6	D	Motion	Motion Control Time Out	The target destination is not reached within a set time limit from the initiation of a downward motion, without the presence of some other error condition, indicating either a grill obstruction or possible control problem	Any	Initial target is not reached within 10 seconds from the initiation of the downward motion (eg cook cycle start; downward platen move for calibration, sleep)	"Reverse and move to Hood Height position if possible; Heaters: ALL are OFF Wait for operator input"
6	S	Motion	Motion Control Time Out	The target destination is not reached within a set time limit from the initiation of platen move between cook stages (can be up or down motion) without the presence of some other error condition, indicating either a grill obstruction or possible control problem	Cooking	Initial target is not reached within 4 seconds from the initiation of the downward motion (eg cook cycle start; downward platen move for calibration, sleep)	"Reverse and move to Hood Height position if possible; Heaters: ALL are OFF Wait for operator input"
6	U	Motion	Motion Control Time Out	The target destination (usually the hood height) is not reached within a set time limit from the initiation of an upward motion (initiated manually or by the control), without the presence of some other error condition, indicating either a grill obstruction or possible control problem	Any	Target is not reached within 10 seconds from the initiation of the upward motion (eg cook cycle end; upward move exiting calibration or sleep)	"Stop motion - Heaters: ALL are OFF Wait for operator input"

DIAGNOSTICS EVENTS LIST, *continuation*

"Event" Index"	Event Suffix (if Applicable)	Event Group	Event Description	Event Cause	State	Error generation criteria	Machine Action
7		Motion	System Error Causes The Grill To Lose Its Home Reference / The Unit Needs To Be Recalibrated	SIB resets and platen need to be recalibrated or software error	Any		"Reverse and move to Hood Height position if possible; Heaters: ALL are OFF Wait for operator input"
9		Temperature	The control detects an Upper IR TC as Open or Above Normal Temperature Range	This is an 'out of range' error, in the positive side this is the same as open thermocouple. In the negative side, we can get a reversed thermocouple, we will go out of range when the heaters are turned on. This error should prevent the use of the platen for cooking. (ie FLAT MODE COOKING ONLY)	Any	Open TC/temp above ~700 F (measured with current filtering)	"Reverse and move to Hood Height position if possible; Heaters: ALL are OFF Wait for operator input"
10	R/L	Temperature	The control detects an Upper Grate TC as Open or Above Normal Temperature Range	This is an 'out of range' error, in the positive side this is the same as open thermocouple. In the negative side, we can get a reversed thermocouple, we will go out of range when the heaters are turned on. This error should prevent the use of the platen for cooking. (ie FLAT MODE COOKING ONLY)	Any	Open TC/temp above ~700 F (measured with current filtering)	"Reverse and move to Hood Height position if possible; Heaters: ALL are OFF Wait for operator input"
11	R/L	Temperature	The control detects a Grill TC as Open or Outside of Normal Temperature Range	This is an 'out of range' error, in the positive side this is the same as open thermocouple. In the negative side, we can get a reversed thermocouple, we will go out of range when the heaters are turned on. This error should prevent cooking.	Any	Open TC/temp above ~700 F (measured with current filtering)	"Reverse and move to Hood Height position if possible; Heaters: ALL are OFF Wait for operator input"

DIAGNOSTICS EVENTS LIST, *continuation*

"Event" Index	Event Suffix (If Applicable)	Event Group	Event Description	Event Cause	State	Error generation criteria	Machine Action
12		Temperature	The control detects Lower IR TC as Open or Outside of Normal Temperature Range	This is an 'out of range' error, in the positive side this is the same as open thermocouple. In the negative side, we can get a reversed thermocouple, we will go out of range when the heaters are turned on. This error should prevent cooking.	Any	Open TC/temp above ~700 F (measured with current filtering)	"Reverse and move to Hood Height position if possible; Heaters: ALL are OFF Wait for operator input"
13		Temperature	The control detects Upper IR TC as Ungrounded	Ungrounded TC	Any	Ungrounded TC	"Reverse and move to Hood Height position if possible; Heaters: ALL are OFF Wait for operator input"
14	R/L	Temperature	The control detects one of the Upper Grate TCs as Ungrounded	Ungrounded TC. Note: Due to the detection method MOST ungrounded grate TC errors will be reported as Alarm 14L. All four thermocouples should be checked to resolve the error.	Any	Ungrounded TC	"Reverse and move to Hood Height position if possible; Heaters: ALL are OFF Wait for operator input"
15	R/L	Temperature	The control detects one of the Lower Grate TCs as Ungrounded	Ungrounded TC. Note: Due to the detection method MOST ungrounded grate TC errors will be reported as Alarm 14L. All four thermocouples should be checked to resolve the error.	Any	Ungrounded TC	"Reverse and move to Hood Height position if possible; Heaters: ALL are OFF Wait for operator input"
16		Temperature	The control detects Lower IR TC as Ungrounded	Ungrounded TC	Any	Ungrounded TC	"Reverse and move to Hood Height position if possible; Heaters: ALL are OFF Wait for operator input"
17		Temperature	Suspected Upper IR Heater Problem	While full power is requested, the process value doesn't change by Heat Recovery temp setting within Heat Recovery time setting indicating there might be a problem with the heater or control circuit.	Any	Fail to rise 5 F within 7 minutes when heater at full power	"Reverse and move to Hood Height position if possible; Heaters: ALL are OFF Wait for operator input"

DIAGNOSTICS EVENTS LIST, *continuation*

"Event" Index"	Event Suffix (If Applicable)	Event Group	Event Description	Event Cause	State	Error generation criteria	Machine Action
18	R/L	Temperature	Suspected Platen Heater Problem	While full power is requested, the process value doesn't change by Heat Recovery temp setting within Heat Recovery time setting indicating there might be a problem with the heater or control circuit.	Any	Fail to rise 5 F within 7 minutes when heater at full power	"Reverse and move to Hood Height position if possible; Heaters: ALL are OFF Wait for operator input"
19	R/L	Temperature	Suspected Grill Heater Problem	While full power is requested, the process value doesn't change by Heat Recovery temp setting within Heat Recovery time setting indicating there might be a problem with the heater or control circuit.	Any	Fail to rise 5 F within 7 minutes when heater at full power	"Reverse and move to Hood Height position if possible; Heaters: ALL are OFF Wait for operator input"
20		Temperature	Suspected Lower IR Heater Problem	While full power is requested, the process value doesn't change by Heat Recovery temp setting within Heat Recovery time setting indicating there might be a problem with the heater or control circuit.	Any	Fail to rise 5 F within 7 minutes when heater at full power	"Reverse and move to Hood Height position if possible; Heaters: ALL are OFF Wait for operator input"
21		Temperature	Sensor detecting temperature in excess of High Temperature - Upper IR	Thermocouple is reading a temperature >685 F at some point other than during a cook cycle	Any	See cause statement	"Reverse and move to Hood Height position if possible; Heaters: ALL are OFF Wait for operator input"
22	R/L	Temperature	Sensor detecting temperature in excess of High Temperature - Upper Grates	Thermocouple is reading a temperature >520 F at some point other than during a cook cycle	Any	See cause statement	"Reverse and move to Hood Height position if possible; Heaters: ALL are OFF Wait for operator input"
23	R/L	Temperature	Sensor detecting temperature in excess of High Temperature - Lower Grates	Thermocouple is reading a temperature >520 F at some point other than during a cook cycle	Any	See cause statement	"Reverse and move to Hood Height position if possible; Heaters: ALL are OFF Wait for operator input"

DIAGNOSTICS EVENTS LIST, *continuation*

"Event" Index"	Event Suffix (If Applicable)	Event Group	Event Description	Event Cause	State	Error generation criteria	Machine Action
24		Temperature	Sensor detecting temperature in excess of High Temperature - Lower IR	Thermocouple is reading a temperature >685 F at some point other than during a cook cycle	Any	See cause statement	"Reverse and move to Hood Height position if possible; Heaters: ALL are OFF Wait for operator input"
25		Motion	Lower Reference Switch Failure	The LRS is not seen during calibration.	During cold home or hot home	After finding the URS, the platen moves the maximum allowed stroke of 2.900 inches for safe operation without finding the LRS	"Reverse and move to Hood Height position if possible; Heaters: ALL are OFF Wait for operator input"
30		System	Lane Communication or Internal Programmatic Error	Defective circuit on UI or SIB; Broken wire; Electrically noisy environment	Any	SIB unable to communicate with UI	"Reverse and move to Hood Height position if possible; Heaters: ALL are OFF Wait for operator input"
31		System	Hardware Problem self-detected on SIB	Defective circuit on SIB; Memory and/or software corruption on SIB	Any	Self-detected SIB error	"Reverse and move to Hood Height position if possible; Heaters: ALL are OFF Wait for operator input"

Notes associated with event number.

- The broiler is designed and rated for operating conditions where the temperature is above 32F
- Below 32F the actuator and upper platen may have higher friction and this results in slowed or sticky motion and overcurrent errors (alarms 6 and 2)
- The motor and all grates must warm up for the unit to function
- An incorrect high temperature alarm message may be displayed: instead of reporting that the temperature is below 32F it will report a high temperature alarm (alarms 21-24)
- If any alarm from 21-24 is seen, the user should press the thermometer button to see the reported temperatures. All zones must be above 32F before the alarm clears.
- Reported grate temperatures may be lower than expected due to offsets; grill start-up may be delayed as a result (unless the store warms the grates through some other means)
- If an alarm was seen on start-up, the unit may not have finished its homing sequence: if the Press & Go button is greyed out, turn the power off for 20 seconds then restart

TROUBLESHOOTING STEPS

Cooking Issues		
Problem	Possible Cause	Action
Undercooked product	Incorrect recipe selected	Select correct recipe and retry
	Cook time too low	Use cook cycle change screen to increase cook cycle
	Raw product too cold	Check that uncooked product is at correct temperature (not frozen) as per CFA operational guideline
	Raw product too thin	Use cook cycle change screen to decrease cook gap, as per CFA operational guideline
	Incorrect product placement	Follow recommended product placement guidelines, as per CFA operational guideline
	Product not prepared correctly	Follow recommended procedure to thaw and filet product, as per CFA operational guideline
	Run size too high	Do not exceed recommended full run size, as per CFA operational guideline
	Cook cycle stopped/aborted early by operator	Discard product
	Cook cycle stopped/aborted early automatically	Discard product, record alarm type and number
	Carbon buildup on grates or heating elements	Clean elements and grates as necessary
	Upper grate not latched properly	Follow procedure to open then relatch upper grate
	Incorrect gap setting	See: Clamshell Issues
	Inconsistent gap setting (front to back or side to side)	See: Clamshell Issues
	Broiler not at temperature before starting cycle	Use temperature status screen to check zone temperatures versus setpoint
Broiler temperature incorrect	See Temperature Issues	

TROUBLESHOOTING STEPS

Cooking Issues (continuation)		
Problem	Possible Cause	Action
Undercooked product only at front of grill	Upper grate not latched properly	Follow procedure to open then relatch upper grate
	Kitchen ventilation affecting temperatures	Check whether cool or high volumes of air are directed towards the broiler
	Grease tray not in place	Ensure grease tray is installed and fully seated
	Grates uneven or warped	See: Clamshell Issues
	Inconsistent gap setting (front to back or side to side)	See: Clamshell Issues
Over cooked	Incorrect recipe selected	Select correct recipe and retry
	Cook time too high	Use cook cycle change screen to decrease cook cycle, as per CFA operational guideline.
	Raw product too warm	Check for correct temperature (frozen product not thawed; thawed product must be 40F or lower) as per CFA operational guideline
	Raw product too thick	Use cook cycle change screen to increase cook gap, as per CFA operational guideline
	Poor quality raw product	Retry recipe with newer product, as per CFA operational guideline
	Used +45 sec button after cook cycle	Use cook cycle change screen to increase cook cycle
	Incorrect gap setting	See: Clamshell Issues
	Inconsistent gap setting (front to back or side to side)	See: Clamshell Issues
	Broiler over temperature before starting cycle	Use temperature status screen to check zone temperatures versus set point.
Broiler temperature incorrect	See Temperature Issues	
Add Time (+45 sec) button not visible	Recipe changed	Add time button only available when last cooked recipe is selected. Select the last cooked item to make +45 sec button visible

TROUBLESHOOTING STEPS

Temperature Issues		
Problem	Possible Cause	Action
Grates or IR too hot	Recipe set points are high	Use temperature status screen to check zone temperatures versus set point
	Temperature calibration incorrect	Reset offsets to default value and verify temperatures (TLF = -25F, TRR = -25F, TIR = 0F, BLR = -10F, BLF = -20F, BIR = 0F)
	Partial load cooking driving temperature on unused zone	Cook full load and recheck zone temperatures
	Thermocouple wiring incorrect (Grates)	Select the temperature status screen. Place a wet rag onto each thermocouple location and watch for a temperature drop at that zone.
	Thermocouple wiring incorrect (IR or Grates)	Use wiring diagram to check that thermocouple wiring is correct
	Intermittent thermocouple fault	Check wiring and connections to SIB
	Heater wiring incorrect (IR or Grates)	Use wiring diagram to check Triac mapping. Place a wet rag onto each thermocouple location and watch for LED activity on SSRB at the correct location
	High temperature switch defective	Check state of switch, measuring current will confirm the switch is below trip point.
	Grate assembly defective	Replace

TROUBLESHOOTING STEPS

Temperature Issues (continuation)		
Problem	Possible Cause	Action
Grates or IR too cool	Recipe set points are low	Use temperature status screen to check zone temperatures versus set point
	Kitchen ventilation affecting temperatures	Check whether cool or high volumes of air are directed towards the broiler
	Temperature calibration incorrect	Reset offsets to default value and verify temperatures (TLF = -25F, TRR = -25F, TIR = 0F, BLR = -10F, BLF = -20F, BIR = 0F)
	Thermocouple wiring incorrect (Grates)	Select the temperature status screen. Place a wet rag onto each thermocouple location and watch for a temperature drop at that zone.
	Thermocouple wiring incorrect (IR or Grates)	Use wiring diagram to check that thermocouple wiring is correct
	Heater wiring incorrect (IR or Grates)	Use wiring diagram to check Triac mapping. Place a wet rag onto each thermocouple location and watch for LED activity on SSRB at the correct location
	Intermittent thermocouple fault	Check wiring and connections to SIB
	Defective heating element	Check for continuity
Unable to reach or maintain temperature	Grate not fully closed	Ensure lower grates are closed
	High temperature switch tripped	Test that contactor is disengaged by opening lower grate and listening for contactor
	Contactor disengaged	Open lower grate and listen for contactor disengaging
	Ribbon cable disengaged	Reseat ribbon cable on SSRB and SIB
	Line voltage wiring harness disengaged	Reseat wiring harness on SSRB
	Ribbon cable damaged	Replace ribbon cable
	Hardware failure on SSRB	Raise the setpoint and ensure green LED on the SSRB lights up
Temperature calibration incorrect	Reset offsets to default value and verify temperatures (TLF = -25F, TRR = -25F, TIR = 0F, BLR = -10F, BLF = -20F, BIR = 0F)	

TROUBLESHOOTING STEPS

UI issues		
Problem	Possible Cause	Action
No sound	Volume set too low	Set volume to high
	Speaker wiring incorrect	Check that speaker connector is seated on both pins
	UI audio defective	Check for voltage at the speaker pins on UI when sound is expected
	Speaker defective	Check with known good speaker
UI not lit	Main power lost	Use voltmeter to confirm main power connected and live
	Connection to SIB lost	Check that Cat5/RJ45 cable seated correctly at UI and SIB. Unplug and replug to force reboot
	24v power supply defective	Check for blinking heartbeat LED on SIB
Screen locked out, frozen, non responsive to touch	Software issue	Turn off broiler using main power switch, turn on after 10 seconds. If not working, connect a mouse to the USB port and check for pointer movement
UI rebooting	Main power intermittent	Use voltmeter to confirm main power connected and live
	Wrong software version loaded	Check that software version is up to date
	24v power supply defective	Check for blinking heartbeat LED on SIB
Unable to read USB	Flash drive not in long enough	Allow 30 seconds for USB to be recognized by UI
	Flash drive not recognized	Go to Settings/USB Operations/Collect Log and check whether log file is collected or if flash drive not recognized
	Flash drive not recognized after removal	Power cycle broiler with flash drive plugged in
	Flash drive faulty	Retry with known good flash drive
	Flash drive set to read only	Check USB manufacturer's website for information
	USB cable disconnected	Check USB connector seated properly from UI to front panel

TROUBLESHOOTING STEPS

UI issues (continuation)		
Problem	Possible Cause	Action
Unable to load USB files	Flash drive faulty	Retry with known good flash drive
	Files on flash drive not unzipped	Unzip compressed file and save to root directory of USB
	Files on flash drive incorrect or corrupt	Delete all files on flash drive and reload update files
	USB cable disconnected	Check USB connector seated properly from UI to front panel
UI cracked	Damage in transit or in-store.	Investigate cause and replace

Clamshell Issues		
Problem	Possible Cause	Action
Wrong Gap Setting	Gap calibration lost or incorrect	Verify gap using gauge block, retry gap calibration if necessary
	Platens warped or uneven	Verify gap at multiple points using gauge block
Inconsistent gap setting	Platen not level from front to back	Correct platen level (see manual)
	Platen not level from side to side	Correct platen level (see manual)
Platen not moving	High temperature switch tripped	Test that contactor is disengaged by power cycling broiler and listening for contactor
	Over travel switch tripped	Check limit switches, ensure wiring is routed correctly
	Hood height not set or set too low	Go to Settings/Hood Height Calibration to check setting
	Actuator failure	Check the actuator for damage, feel for motor vibration indicating motor is attempting to move
	Platen motor fuse blown	Check SIB fuse, replace and recheck
	Loose connector on SIB	Check that all wires are fully inserted in connector block and that connectors are properly seated on SIB by pushing down on connector (do not pull)
	EMI interference	Check that CAT 5 (network) cable is routed away from SIB

TROUBLESHOOTING STEPS

Clamshell Issues (continuation)		
Problem	Possible Cause	Action
Platen over travel	Gap calibration lost or incorrect	Verify gap using gauge block, retry gap calibration if necessary
	Hood height set too high	Go to Settings/Hood Height Calibration to lower setting
	Limit switch failure	Check limit switch for correct operation
	Loose connector on SIB	Check that all wires are fully inserted in connector block and that connectors are properly seated on SIB by pushing down on connector (do not pull)
	SIB I/O failure	Check LED and manually operate limit switches.
	Gap calibration lost or incorrect	Verify gap using gauge block, retry gap calibration if necessary
	Upper reference switch in wrong position	Check upper reference switch is positioned below over travel switch
	Limit switch bracket loose	Check bracket and tighten if necessary

BROILER ACCESSORIES, PART LIST

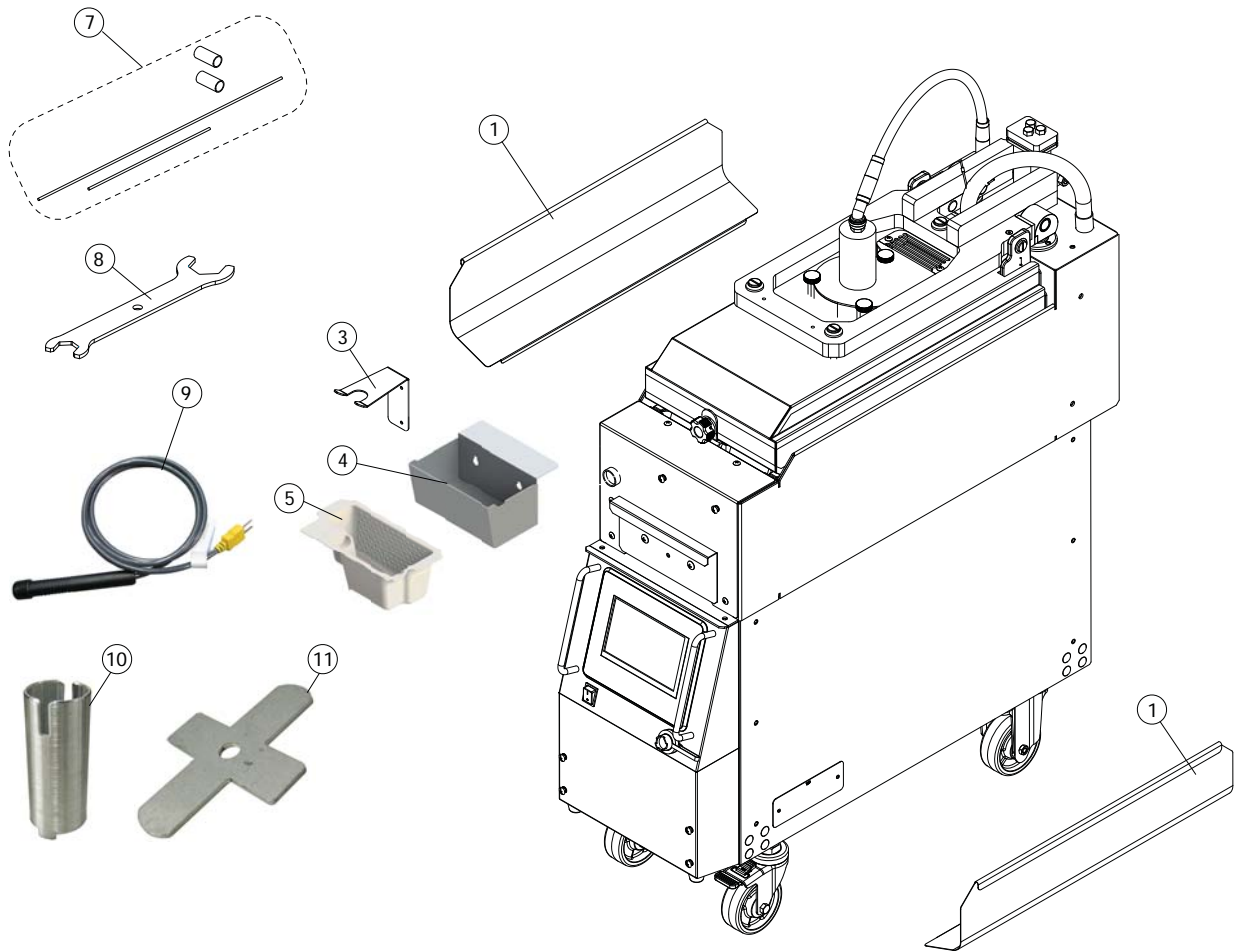

01 - CFA Broiler Assembly

ITEM #	PART #	DESCRIPTION	1P	CRITICAL
1	4531822	BROILER BOX INNER RT/LT	2	
3	4532092	BRUSH /SCRAPER HOLDER	1	
4	4532519	OIL TRAY ASSEMBLY	1	
5	4532550	OIL TRAY INSERT (PACK OF 10)	1	
7	4532541	SERVICE TOOL, GAUGE BLOCK, COMMON (CALIBRATION TOOL)	2	
8	4532089	SERVICE TOOL, WRENCH	1	
9	4532297	SERVICE TOOL, CFA BROILER TEMPERATURE PROBE	1	
10	4532097	SERVICE TOOL, ADJUSTMENT TUBE	1	
11	4532098	SERVICE TOOL, ADJUSTMENT CROSS	1	

BROILER INTERIOR, PART LIST

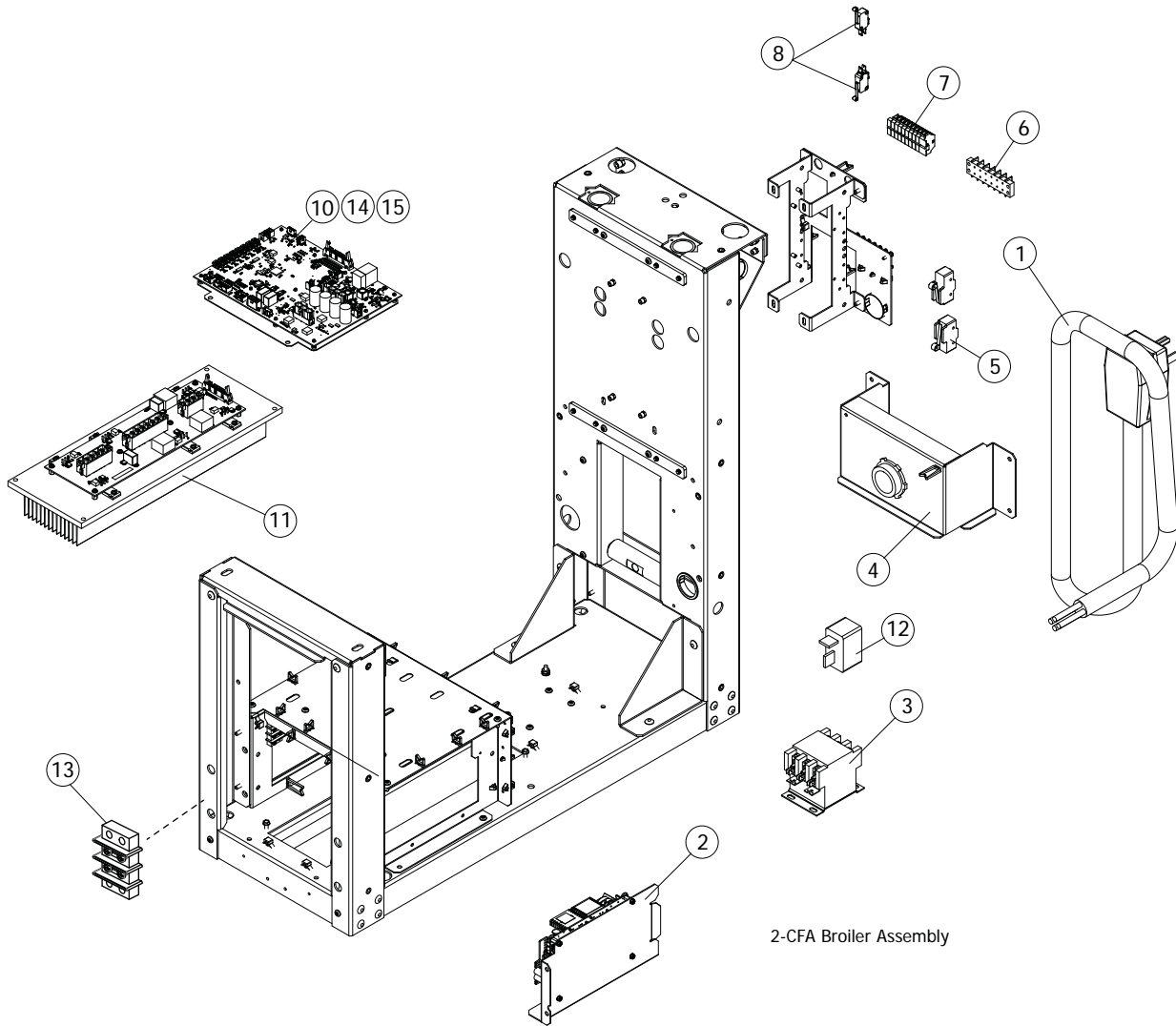

2-CFA Broiler Assembly

ITEM #	PART #	DESCRIPTION	1P	CRITICAL
1	4532046	CFA POWER CORD ASSEMBLY	1	
2	4532159	POWER SUPPLY - 24VDC	1	C
3	4531927	CONTACTOR, 3 POLE	1	C
4	CK4532026	STRAIN RELIEF PLATE ASSEMBLY	1	
5	1855601	UPPER / LOWER LIMIT SWITCH	2	C
6	4532045	TERMINAL BLOCK - THERMOCOUPLE	1	
7	4531929	TERMINAL BLOCK 9 POLES - PLATEN	1	
8	4531930	SWITCH -OMRON MICRO 250V, 21 A	2	C
10	CK4532103	SIB BOARD & MOUNT PLATE ASSY	1	C
11	4531775	SSRB HEATSINK ASSY	1	C
12	4531933	DIODE 15A	2	
13	4532161	TERMINAL BLOCK, 2 POLE	1	
14	4532613	FUSE, 10 AMPS, CFA SIB BOARD	1	C
15	4532614	FUSE, 2 AMPS, CFA SIB BOARD	1	C

BROILER EXTERIOR, PART LIST

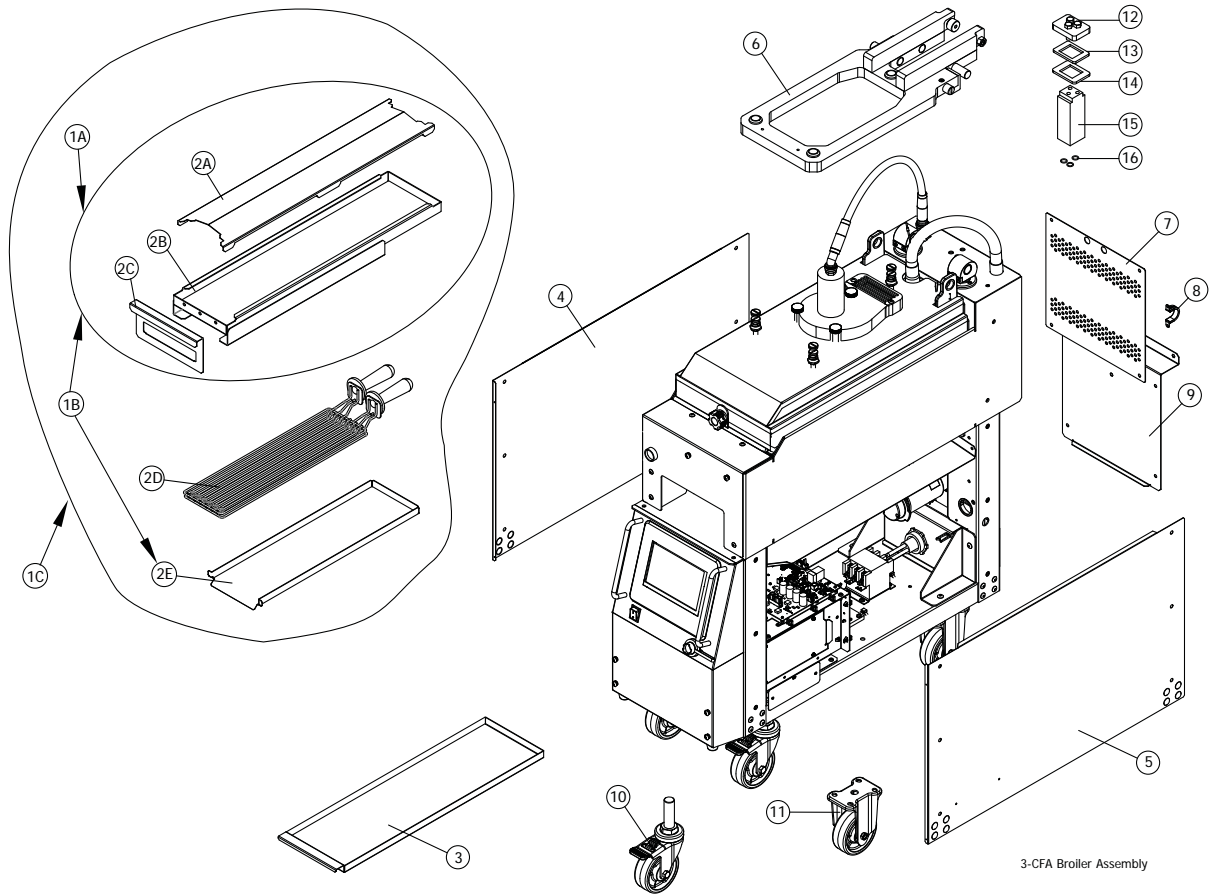

3-CFA Broiler Assembly

ITEM #	PART #	DESCRIPTION	1P	CRITICAL
1A	CK4532322	GREASE DRAWER ASSEMBLY KIT (INCL. ITEMS 2A, 2B, 2C)		
1B	4532710	GREASE DRAWER KIT W/TRAY (INCL. ITEMS 1A, 2E)	1	
1C	4532325	GREASE DRAWER/NUGGET TRAY AND RACK KIT (ITEMS 1A, 1B, 2D)	1	
2A	4532320	GREASE DRAWER SHIELD	1	
2B	4532319	GREASE DRAWER WELDMENT	1	
2C	4532321	GREASE DRAWER FRONT	1	
2D	4532323	NUGGET TRAY	1	
2E	4532324	NUGGET RACK KIT	1	
3	4531825	CRUMB TRAY	1	
4	4531857	MAIN BODY SIDE PANEL, LT	1	
5	4531856	MAIN BODY SIDE PANEL, RT	1	
6	4531528	PLATEN ARM ASSEMBLY	1	
7	4531948	UPPER BACK CFA	1	
8	4531950	U CLAMP S/S, DIA 1.125"	1	
9	CK4532029	LOWER BACK PANEL ASSY	1	
10	4531978	CASTER-SWIVEL W/4IN PP WHEEL, ALL POS. LOCK, 7/	2	
11	4531979	CASTER-RIGID W/4IN PP WHEEL, PLATE MOUNT	2	
12	4531865	PIVOT TOP	1	
13	4531866	PIVOT CONTACT PLATE	1	
14	4531867	PIVOT COMP GASKET	1	
15	4531864	PIVOT BASE	1	
16	4531861	O-RING, PIVOT BLOCK	3	

BROILER UPPER PLATEN, PART LIST

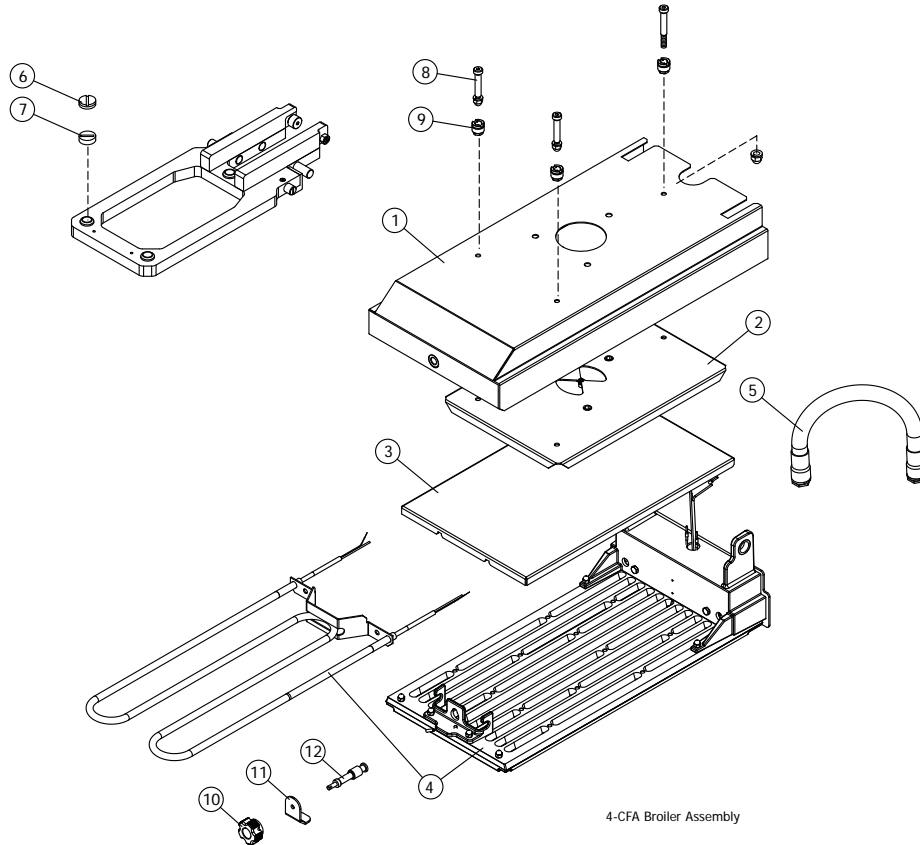

ITEM #	PART #	DESCRIPTION	1P	CRITICAL
1	4531841	COWL ASSY	1	
2	CK4531848	COWL STIFFENER ASSY	1	
3	4531845	SHIELD/PLENUM - UPPER GRATE	1	
4	CK4531849	GRATE AND ELECTRICAL BOX ASSY (INCLUDE PLATEN IR ELEMENT ASSY)	1	C
5	4532106	CONDUIT ASSEMBLY - POWER (SIZE 20)	1	C
6	1859102	PLATEN ADJUSTOR CAP	3	
7	1859103	PLATEN ADJUSTOR LOCK NUT	3	
8	F690	SHOULDER SCREW	3	
9	4531851	9/16 HEX PLATEN ADJUSTOR NUT C/W O-RING	3	
10	4531844	PLATEN KNOB HANDLE	1	C
11	4532047	UPPER GRATE SAFETY CATCH	1	
12	4531843	RELEASE PIN	1	C

BROILER PLATEN EXHAUST ASSEMBLY, PART LIST

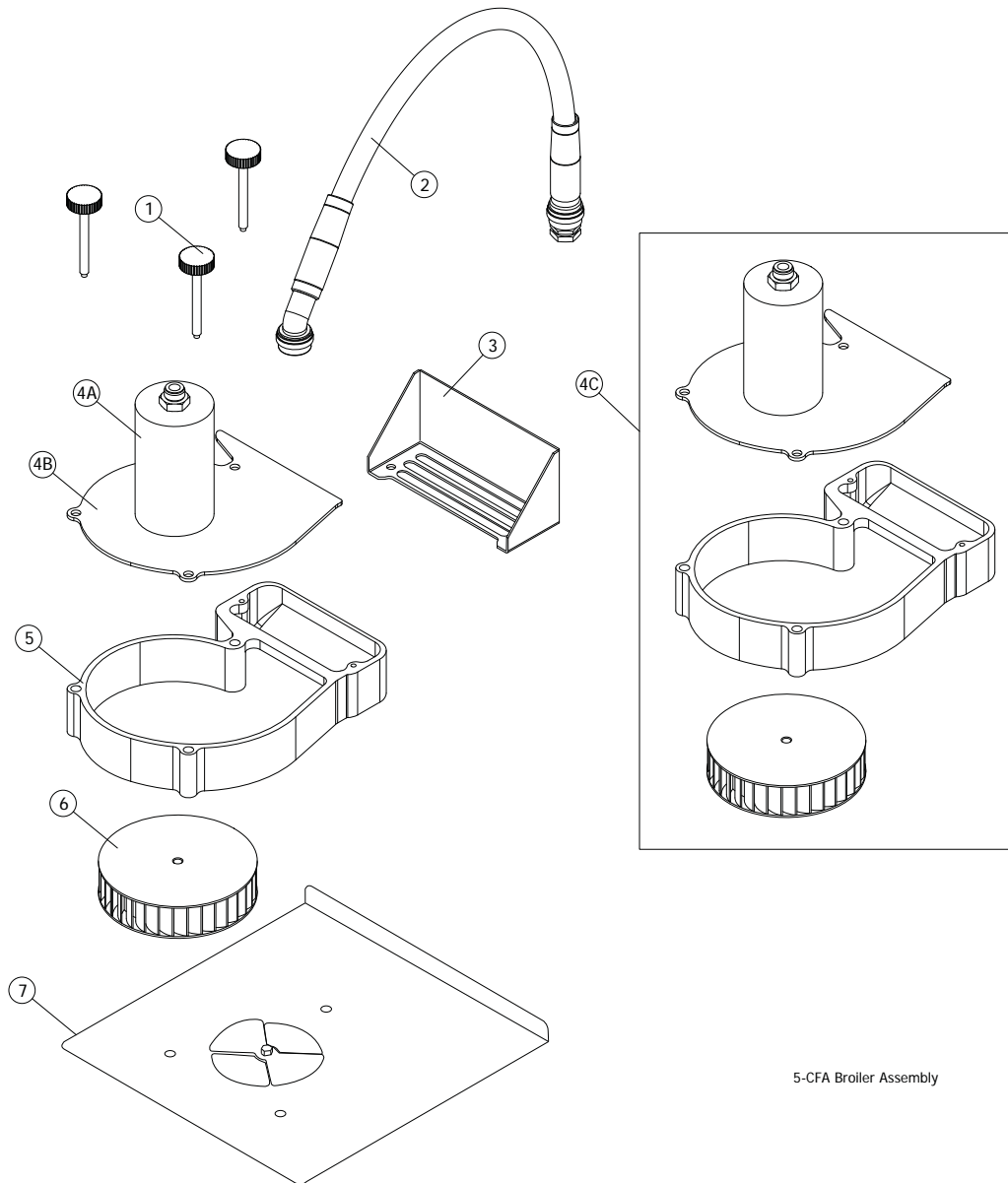

5-CFA Broiler Assembly

ITEM #	PART #	DESCRIPTION	1P	CRITICAL
1	4532507	THUMB SCREW KIT, EXHAUST FAN (3 SCREWS INCLUDED)	1	C
2	4532107	CONDUIT ASSEMBLY - FAN (SIZE 12)	1	C
3	4532571	EXHAUST DEFLECTOR (USE SCREWS F545 , SEE ITEM 8)	1	
4A	4531830	EXHAUST MOTOR, 24V	1	C
4B	4531829	MOTOR PLATE	1	
4C	4532530	EXHAUST FAN KIT (INCL. ITEMS 4A, 4B, 5, 6, HIGH TEMPERATURE SEALANT AND FASTENERS)	1	
5	4531863	EXHAUST HOUSING	1	
6	4531834	BLOWER WHEEL W/SET SCREW	1	C
7	4532456	EXHAUST TRAY ASSEMBLY	1	
8	F545	SCREW, 10-24 X 1/2", PAN HEAD, PHILLIPS, MACHINE (NOT SHOWN)	2	

LOWER BROILER BOX, PART LIST

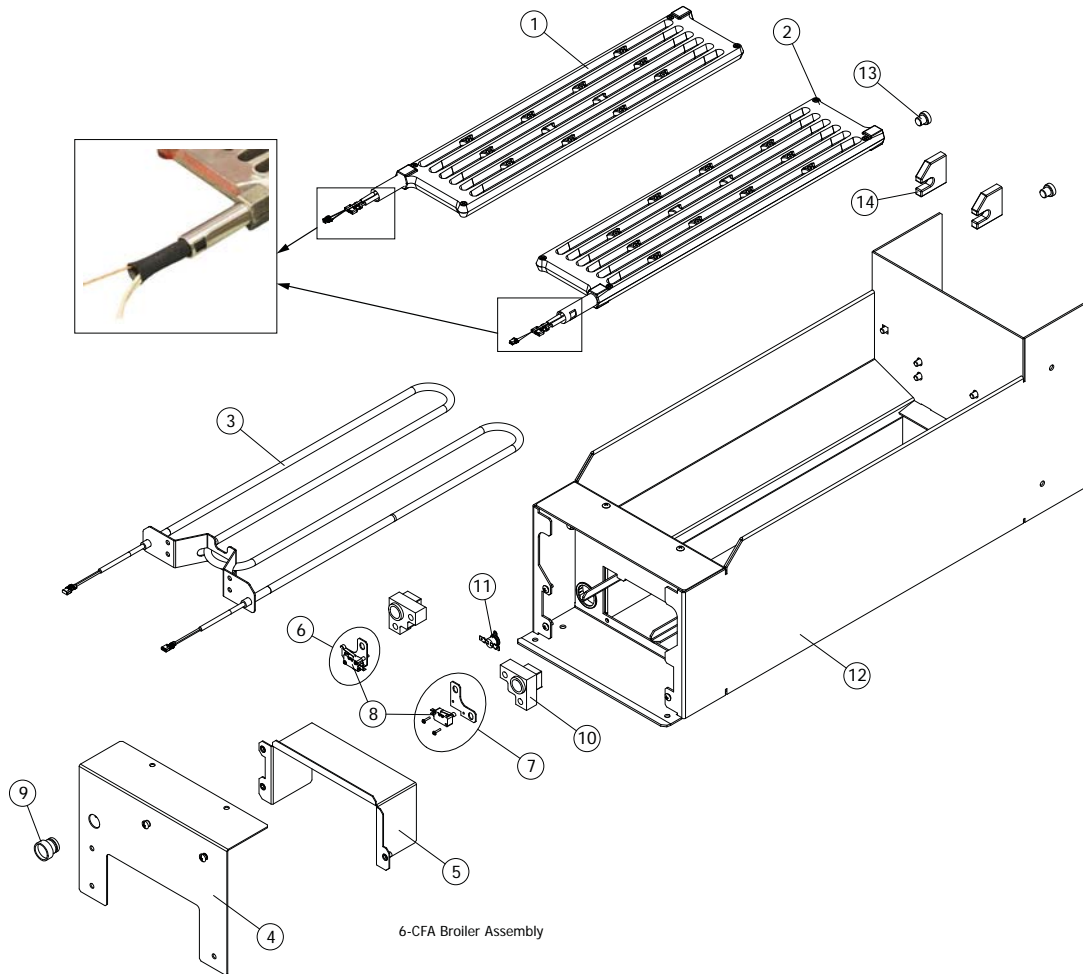

6-CFA Broiler Assembly

ITEM #	PART #	DESCRIPTION	1P	CRITICAL
1	4532664	GRATE ASSY, LOWER LEFT. REPLACES CK4531509 .	1	C
2	4532663	GRATE ASSY, LOWER RIGHT. REPLACES CK4531508 .	1	C
3	4531517	BROILER SECTION IR ELEMENT ASSEMBLY	1	C
4	4531817	BROILER BOX FRONT COVER ASSEMBLY	1	
5	CK4531814	BROILER BOX INNER FRONT ASSEMBLY	1	
6	CK4531869	SWITCH ASSY LH , GRATE LWR (INCL. SWITCH & BRACKET). FOR BRACKETS ONLY, USE 4532668 , SEE ITEM 15.	1	
7	CK4532032	SWITCH ASSY RH, GRATE LWR (INCL. SWITCH & BRACKET). FOR BRACKETS ONLY, USE 4532668 , SEE ITEM 15.	1	
8	4531983	LOWER GRATE SWITCH	2	C
9	4524675	PUSH BUTTON SWITCH ASSY	1	C
10	4531533	PIVOT BUSHING ASM, LOWER GRATE	2	
11	4532088	LIMIT THERMOSTAT (OPEN 257F, CLOSE 230F)	1	C
12	4531813	BROILER BOX - WELDED ASSEMBLY	1	
13	4531534	PIVOT, LOWER GRATE	2	
14	4531535	STOP BLOCK, LOWER GRATE	2	
15*	4532668	SERVICE KIT, LOWER GRATE SWITCH BRACKETS (INCL. TWO SWITCH BRACKETS ONLY. SWITCH NOT INCLUDED)	1	

* NOT SHOWN

BROILER ACTUATOR ASSEMBLY, PART LIST

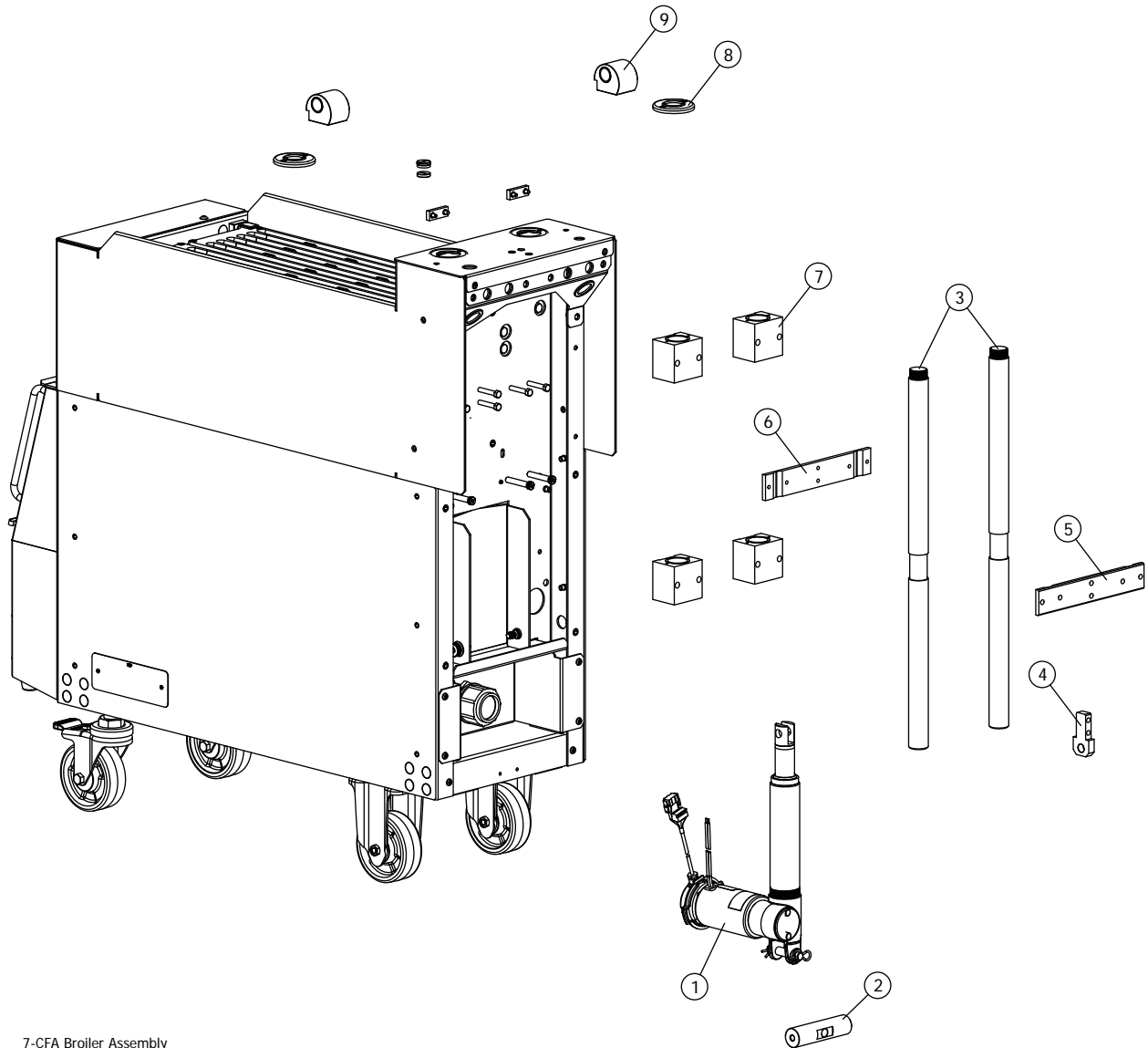

7-CFA Broiler Assembly

ITEM #	PART #	DESCRIPTION	1P	CRITICAL
1	4531780	ACTUATOR ASSEMBLY	1	C
2	4531981	ACTUATOR MOUNT BLOCK, LWR	1	
3	4516084	ACTUATOR SHAFT	2	
4	4531836	YOKE, CROSS BAR	1	
5	4532048	CROSS MEMBER, CLR	1	
6	4531837	CROSS MEMBER, THREADED	1	
7	4531870	PILLOW BLOCK ASSEMBLY, CFA	4	
8	CK4532036	SHAFT SEAL COMPONENTS	2	C
9	4531872	KNUCKLE ASM	2	

CONTROL PANEL, PART LIST

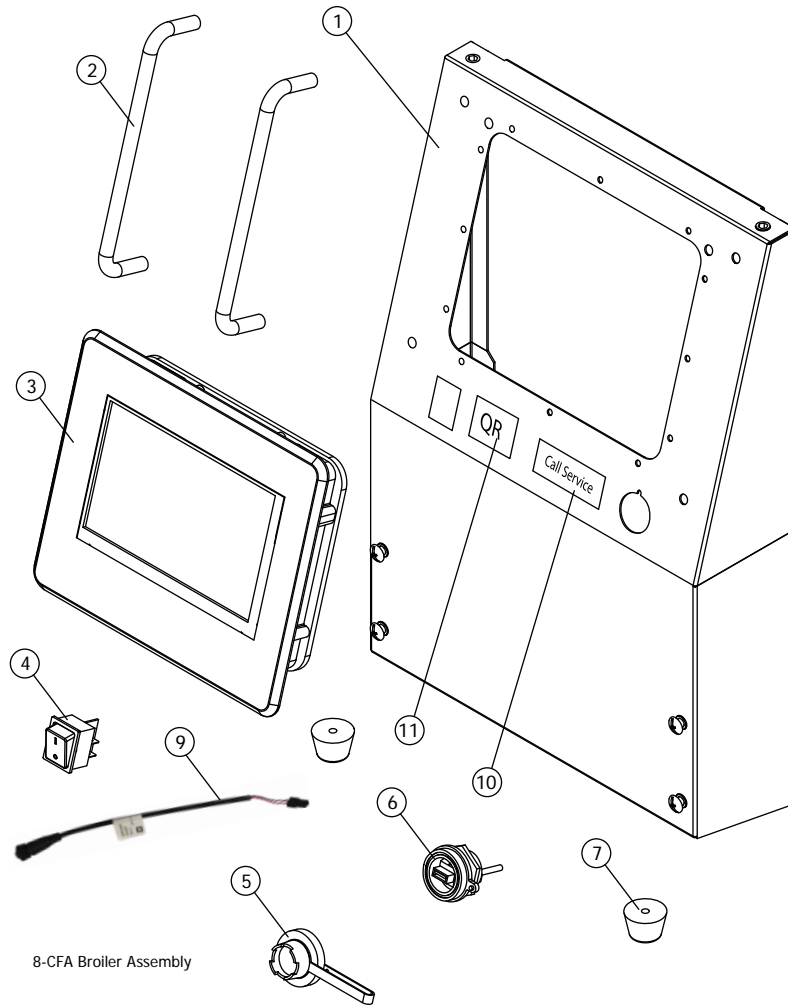

ITEM #	PART #	DESCRIPTION	1P	CRITICAL
1	4532333	CONTROL PANEL COMPLETE ASSEMBLY	1	
2	1859501	HANDLE	2	
3	CK4532600	USER INTERFACE (UI) ASSY - CFA, COMPLETE WITH PROGRAM	1	C
4	4531452	POWER SWITCH GREEN	1	C
5	4532043	USB CABLE ASSY COVER	1	C
6	4532040	USB CABLE ASSY C/W LOCK NUT	1	C
7	4532069	BUMPER RND 1 1/8DIA X3/4H	2	
8	4523482	SPEAKER, 4 WATTS SMT (NOT SHOWN)	1	
9	4532307	WIRE HARNESS, SPEAKER	1	
10	4532162	LABEL - SERVICE CONTACT	1	
11	4532554	LABEL - QR CODE	1	

WIRE HARNESSES, PART LIST

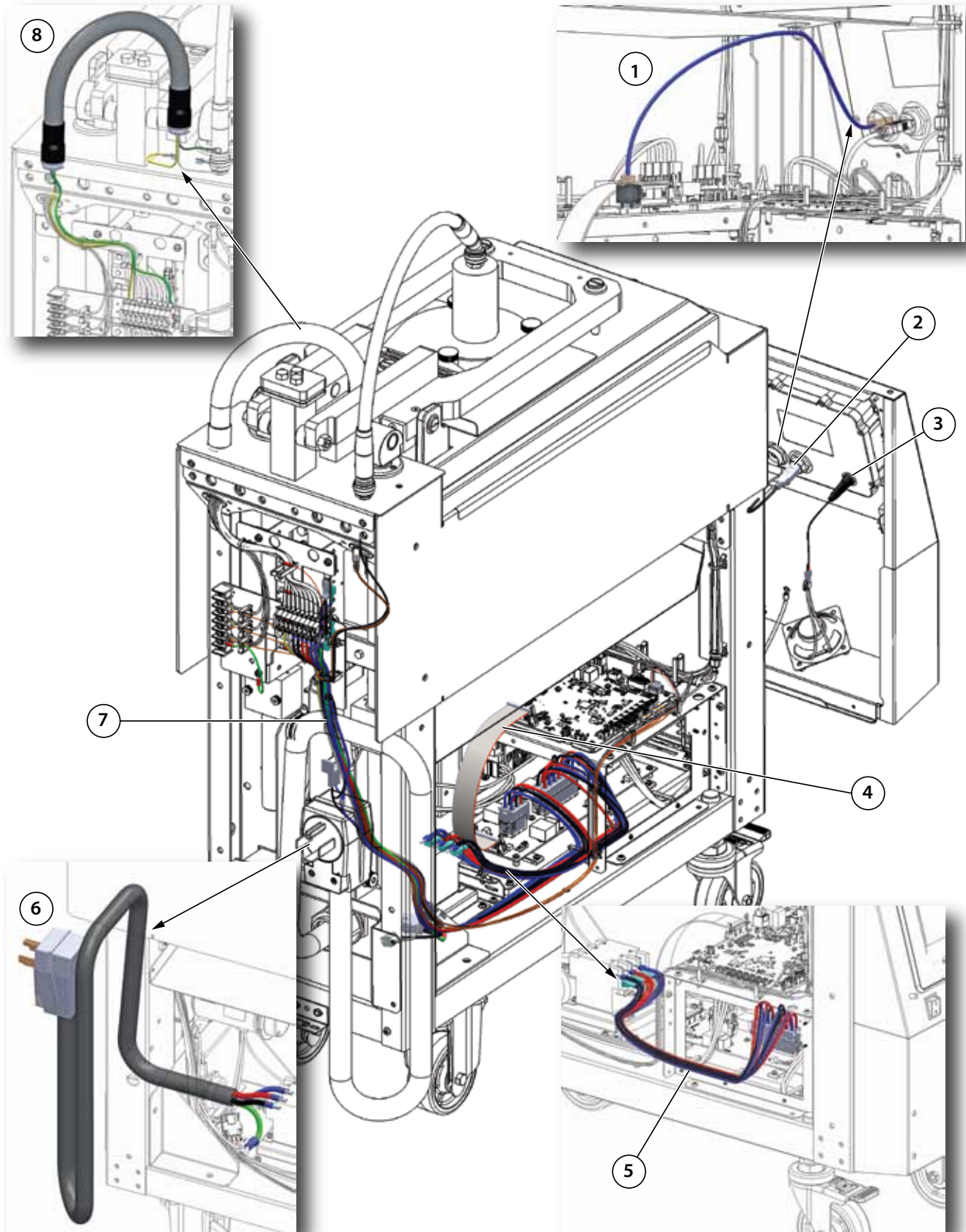

9-CFA Harnesses

WIRE HARNESSES, PART LIST

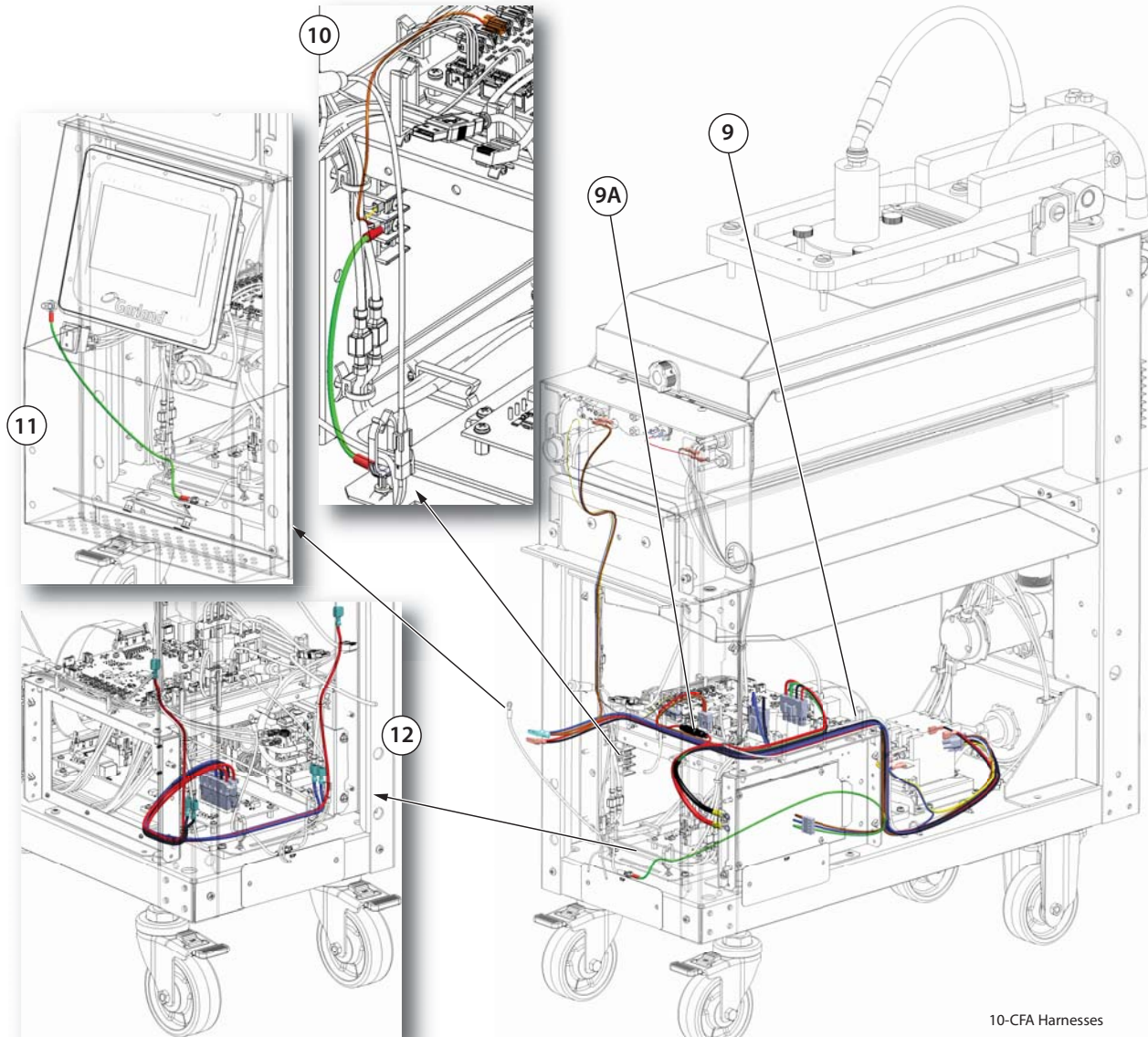

10-CFA Harnesses

ITEM #	PART #	DESCRIPTION	1P	CRITICAL
1	4532101	COMMUNICATION CABLE	1	
2	4532040	USB ASSEMBLY CABLE C/W LOCK NUT	1	
3	4532307	WIRE HARNESS - SPEAKER	1	
4	4532085	RIBBON CABLE, 26 PIN	1	
5	4532082	HARNESS - POWER DISB	1	
6	4532046	POWER CORD ASSEMBLY	1	
7	4532302	HARNESS - TOP ASSEMBLY	1	
8	4532305	HARNESS - PLATEN	1	
9	4532301	HARNES - MAIN	1	
9A	4532612	FUSE, 5 AMPS, CFA MAIN HARNESS (EXHAUST BLOWER MOTOR CIRCUIT)	1	C
10	4532303	HARNESS - TC LOWER IR	1	
11	4532304	GROUND WIRE, FRONT PANEL	1	
12	4532083	HARNESS, POWER, LOWER HEATER	1	

INDEX

A

ACCESSORIES 34
ADJUSTMENT LOWER GRATE 20

B

BACON / SAUSAGE PRODUCT PLACEMENT 44

C

CASTER, ADJUSTMENT 17
CASTERS 9
CLEANING AND MAINTENANCE 37
CLEAN MODE 46
CONTACT PHONE 36
CONTENT 2

D

DIAGNOSTICS 46

E

ELEMENT INFRARED 28, 29
EVENTS # 59

G

GRATE, UPPER 29

H

HOME 46

I

IMPORTANT INFORMATION 2
INFRARED ELEMENT 28, 29

L

LANGUAGE 46
LATCHING 19
LEVELING UPPER PLATEN ASSEMBLY 22, 23, 24
LOCK 46
LOGIC MENU TREE 58

M

MENUS 46

P

PLATE UPPER LEVELLING 23
PRESS & GO 46
PRODUCT UNDERCOOKED 64

R

RATING PLATE 9
RECIPES 46
REPLACEMENT EXHAUST MOTOR ASSEMBLY 26
REPLACEMENT EXHAUST MOTOR FUSE 25
REPLACEMENT LOWER GRATE 27

S

SAFETY 5
SETTING 46
SIB LED's 30, 31, 32, 33
SLEEP 46
SOFTWARE UPDATE 54
SPECIFICATION 7
START UP CHECKLIST 16, 17

T

TEMPERATURE 46
TEMPORARY STORAGE 8
THERMOCOUPLE LOCATIONS 14
THERMOCOUPLE LOCATIONS DIAGRAM 15, 16, 17
TROUBLESHOOTING 64

U

UNLATCHING 18

V

VENTILATION 11

W

WARRANTY 4
WIRING DIAGRAM 81
WOOD CRATE 10

Garland Installation, Operation & Service Manual



GARLAND Broiler MODELS: CXBE12

Manufactured By;
Garland Commercial Ranges
<http://www.garland-group.com>

