

# Operation Manual & Parts List

# Glastender®

A Family Company Manufacturing  
In The USA Since 1969

**SLIDE TOP COOLERS** MANUFACTURE DATE BEGINNING IN **2009**  
AND PRIOR TO **MARCH 27, 2017\***

**MODELS: ST24, ST36, ST48, ST60, ST72, AND ST96**

## \*SLIDE TOP COOLER SERIAL NUMBER INFORMATION

This manual is specific to Slide Top Coolers beginning with the serial numbers and dates listed below **AND MANUFACTURED PRIOR TO MARCH 27, 2017.**

ST24	134121923N	04/09/09	ST60	134124803N	11/23/09
ST36	134121978N	04/13/09	ST72	134124902N	12/01/09
ST48	134124811N	11/23/09	ST96	134125203N	01/04/10



ST36-B



ST48-SF

Glastender, Inc. · 5400 North Michigan Road · Saginaw, MI · 48604-9780  
800.748.0423 · 989.752.4275 · Fax 989.752.4444 · [www.glastender.com](http://www.glastender.com)



# INDEX

<u>TOPIC</u>	<u>PAGE</u>
Terms and Conditions .....	2
Warranty Statement.....	3
Installation.....	4
Operation.....	4
Cleaning Instructions .....	5
Electrical and Refrigeration Specifications .....	5
Wiring Diagrams.....	6 - 7
ST24 and ST36 .....	6
ST48, ST60, ST72 and ST96 .....	7
Evaporator and Related Parts .....	8
Compressor and Condenser Related Parts .....	9 - 10
Refrigeration Compartment Covers.....	11 - 12
Shelving and Related Parts .....	12
Doors, Tops, and Related Parts.....	13
220V Electrical Parts .....	14
Electrical Components.....	14
Light Kits .....	14

# TERMS AND CONDITIONS

**PRICES:**

All prices are LIST. Applicable taxes will be added.

**QUOTATIONS:**

Unless otherwise stated, quotations are effective for 30 days only.

**ACCEPTANCE:**

All orders are subject to acceptance by Glastender, Inc.'s headquarters in Saginaw, Michigan. Possession of the Product Directory and Price List is not an offer to sell.

**SHIPMENTS:**

F.O.B. factory in Saginaw, Michigan. Freight terms are Third Party or Collect if shipped directly to you. Prepay and Add to Invoice freight terms are available upon request. The approximate shipping weights of all products are listed with the prices. Partial shipments will be made unless otherwise specified by the customer. Surface freight classifications are:

- GT-24/GT-30/GW24 Glasswashers - Class 175
- GT-18 Glasswashers - Class 250
- All Underbar Equipment - Class 175
- Bar Die Orders – Class 250
- Portable Bars - Class 175
- Remote refrigerators (i.e., no compressor) or dry storage back bar equipment - Class 175
- Self-contained refrigeration equipment - Class 150
- Ice Display Units (IDU and GDU) - Class 85
- Lighted Liquor Displays - Class 85
- Beer line chillers and beer towers (beverage dispensing equipment) - Class 92.5
- Bottle Disintegration System - Class 150
- Ice Cream Freezers - Class 77.5

All small items are evaluated to see the most cost effective means for shipment. Many small items ship via UPS or FedEx; however, when dimensional weight is excessive, LTL carriers are the most cost effective choice. Spare parts orders received before 1:00 PM EST can usually be shipped the same day.

The order department is happy to assist with routing or shipping questions.

**PAYMENT TERMS:**

Cash should be included with all orders unless credit terms have been arranged. To establish credit, banking and trade references are required. A convenient credit application is available upon request. Payment via credit card is not our normal means of receiving payment. Visa and MasterCard will be accepted, but must be charged at the time of shipment. In addition, a payment via credit card for orders totaling more than \$500 will incur a 3% convenience fee on the total transaction amount.

**DELIVERY:**

The majority of equipment is manufactured to order and typically ships within three to six weeks after complete order information is received by the factory. In-stock equipment typically ships within two to three days of the factory receiving complete order information.

**RETURNS:**

Items specified as "Manufactured to Order" are NOT returnable.

A Return Authorization number must be issued by the factory in advance for any items that are returnable. The number MUST be noted on the outside of the returned package. Returns must be received within 90 days of the issue date. Shipping charges must be prepaid. A minimum 20% restocking charge will be applied to all authorized returns if received in new, unused condition in the original packaging.

The above conditions apply to spare part returns, except spare part returns must be received within 30 days of original shipment for electronic or electrical parts or within 90 days for all other parts.

**LOSS OR DAMAGE:**

For customer routed shipments, Glastender, Inc. is not responsible for any loss, damage, or delay of merchandise during shipment. Such transit claims must be filed with the carrier. Merchandise must be examined on arrival. If shortages occur, Glastender, Inc. must be notified in writing within five (5) days of delivery to honor any shortage claim. Glastender will assume responsibility for freight claims on Prepay and Add shipments but the customer must inspect freight and note any damage upon receipt. Failure to do so may result in losses at the customer's expense.

**CUSTOM ORDERS:**

Custom orders must be paid in advance and are not subject to cancellation.

**LAMINATES:**

Some products include common, readily available plastic laminates of the customer's selection. There may be an additional charge if uncommon varieties are ordered.

12/14/17

# WARRANTY STATEMENT

## APPLICABLE TO ALL PRODUCTS SOLD WITHIN THE UNITED STATES AND CANADA

Glastender, Inc. warrants all products to be free of defects in material and workmanship. One-year labor and parts warranty applies to all glasswashers, self-contained refrigeration models, and BDS model bottle disintegration units. In established areas, a start up is included with GT-24 and GT-30 model glasswashers. Warranty is effective for one year from the date of installation or up to 18 months from date of factory shipment, whichever occurs sooner. Glastender, Inc. will replace any part or assembly found defective under normal use and service.

For warranty labor claims beyond 15 months from the date of factory shipment, proof of date of installation or occupancy must be provided. Authorization for labor must be obtained from Glastender within the warranty period and prior to the service being performed.

Labor warranty applies to the United States and Canada only.

Remote refrigeration models and beer line chillers include a one-year parts warranty only. There is no labor warranty on these products.

Field replacement parts not covered under the original warranty include a 90-day part warranty from the date of installation.

**FOUR YEAR ADDITIONAL COMPRESSOR WARRANTY:** Glastender will warrant to the original user the compressor for all self-contained refrigeration models for an additional four years following the regular one-year warranty period. This plan applies to the compressor only.

A completed warranty claim form **MUST** accompany all returned defective parts or assemblies. Upon request, a defective part or assembly must be returned to Glastender, Inc., Saginaw, Michigan, with all transportation and delivery charges prepaid. Warranty repairs or replacements will be shipped FOB factory in Saginaw, Michigan. Reimbursement for applicable freight charges covers ground service only.

Glastender provides in-warranty repairs during a service company's regular working days and hours. There is no provision for payment of a premium rate during "overtime" hours. When warranty service is requested during other than normal working hours, the end user will be charged the premium portion of the overtime rate.

The warranty covers substantiated travel expenses for up to 2 hours / 100 miles round trip up to a maximum of \$150. Any additional costs due to installations that require extra work, time, or travel to gain access for service are the sole responsibility of the equipment purchaser. Any exceptions to these travel and access limitations must be pre-approved by a factory representative.

The warranty does not cover door gaskets, chemical tubing, pump squeeze tubing, and/or any equipment subjected to accidents, freight damage, alterations from the original design, improper power and/or plumbing hookups, improper chemical use, general misuse, or lack of routine required maintenance as determined by Glastender, Inc. Installation, normal control adjustments, general maintenance, correcting an installation error, or service calls that reveal the unit is functioning normally will not be reimbursed under warranty.

Condenser coils on self-contained refrigeration products must be cleaned regularly. Failure to provide adequate air flow to a refrigeration unit will void the warranty.

Glastender shall not be liable for loss of use, revenue, or profit, or for any other indirect, incidental, special, or consequential damage including, but not limited to, product spoilage or loss.

This warranty is conditioned upon Glastender receiving notice of any defect subject to this warranty within sixty (60) days of its discovery by the end user or dealer. All products are warranted only for the initial place of installation. Removal of a product automatically terminates this warranty.

### SECOND YEAR EXTENDED PARTS & LABOR WARRANTY:

Glastender's one-year parts and labor warranty on self-contained refrigeration units, excluding beer line chillers, can be extended to two years with the purchase of a two year parts and labor warranty. Specify part number EWR2 (\$150 net price) when ordering.

EXPORT WARRANTY - One year parts only.

### EXCLUSION OF WARRANTIES

EXCEPT AS PROVIDED ABOVE, GLASTENDER MAKES NO WARRANTIES, EXPRESS OR IMPLIED, INCLUDING, BUT NOT LIMITED TO, ANY IMPLIED WARRANTY OF MERCHANTABILITY, FITNESS FOR A PARTICULAR PURPOSE OR NON-INFRINGEMENT.

### LIMITATION OF REMEDIES AND DAMAGES

If Buyer makes a valid and timely claim as outlined above, Glastender's liability and Buyer's remedies under this agreement will be limited solely to labor charges authorized and/or replacement or credit, at Glastender's option, with respect to Products returned at Buyer's expense within thirty (30) days after warranty repair. GLASTENDER'S LIABILITY WILL IN NO EVENT BE GREATER IN AMOUNT THAN THE PURCHASE PRICE OF THE RETURNED PRODUCTS. GLASTENDER WILL NOT BE LIABLE UNDER ANY CIRCUMSTANCE FOR CONSEQUENTIAL OR INCIDENTAL DAMAGES, INCLUDING, BUT NOT LIMITED TO, LABOR COSTS EXCEPT AS COVERED UNDER OUR WARRANTY, LOST PROFITS OR THE LOSS OF PERISHABLE PRODUCTS RESULTING FROM THE USE OF OR INABILITY TO USE OUR PRODUCTS OR FROM OUR PRODUCTS' INCORPORATION INTO OR BECOMING A COMPONENT OF ANY OTHER PRODUCT. NEITHER PARTY WILL HAVE ANY NEGLIGENCE OR OTHER TORT LIABILITY TO THE OTHER, OR TO ANY THIRD PARTY, ARISING FROM ANY BREACH OF THIS AGREEMENT.

### GOVERNING LAW - JURISDICTION

The terms and conditions of an order are to be governed and construed according to the laws of the State of Michigan, without regard to conflict of laws principles. Buyer hereby consents to the jurisdiction and venue of the courts located in Saginaw County, Michigan.

No representative, distributor, dealer, or any other person is authorized to modify this warranty. This warranty replaces all other written or verbal warranties.

NOTE: Glastender, Inc.'s policy of constant quality improvement means that prices, specifications, and policies are subject to change without notice. Questions regarding this warranty should be directed to Glastender's Warranty Administrator.

04-19-17

## **IMPORTANT!!**

### Attention Service Companies

Please review the important warranty information on this page. If you believe a service call should be covered by the factory, please call the factory for authorization between 8AM and 5PM EST, Monday through Friday.

# INSTALLATION

## INTRODUCTION

---

This manual describes the operational features of Slide Top Coolers. Please review this information before attempting installation and operation.

Long term, trouble-free service will follow if good housekeeping and maintenance procedures are followed. Thank you for selecting Glastender, Inc. products.

## UTILITY REQUIREMENTS AND CONNECTIONS

---

- **Electrical:** 120 Volt AC, 1 Phase, 60 Hz. A separate 15 Amp circuit is recommended. A 6-foot grounded cord is included.
- **Plumbing:** None required. Automatic condensate evaporator is included.

## UNCRATING AND START-UP INSTRUCTIONS

---

All Slide Top Cooler models are shipped in one carton. These steps should be followed:

1. If legs or casters are included, bolt them to the base with the bolts provided.
2. Unwrap power cord from base.
3. Position unit and level and/or seal as required (see page 1-2).
4. Place racks in desired location.
5. Plug into 115 volt AC outlet.
6. Load with bottles or cans and allow time to cool. For best performance, load with pre-cooled bottles or cans. It is recommended that back-up product be stored in a walk-in cooler.
7. Your Glastender equipment is now ready for use.

## SEALING SLIDE TOP BASE TO FLOOR

---

To comply with NSF & health codes. The slide top base must be sealed to the floor using NSF listed sealant. Place bead of sealant along outer edges of the base and remove excess with disposable towel.



## OPERATION

---

The Slide Top Cooler is designed to maintain bottles and cans at an operating temperature range of 36°F (2°C) to 40°F (5°C).

Slide Top Coolers include an automatic defrost system. The cooler will defrost every six hours for approximately 20 minutes. During the defrost, the fan inside the cooler will remain on and the refrigeration system will turn off.

# CLEANING INSTRUCTIONS, ELECTRICAL & REFRIGERATION SPECS

## CLEANING INSTRUCTIONS

Cleaning is essential to sustaining the integrity of your equipment and preventing corrosion.

**ESTIMATED CLEANING TIME:** 5 to 10 minutes per unit daily, 45 minutes quarterly

**FREQUENCY:** Daily cleaning of exterior & door gaskets. Quarterly cleaning of interior, including shelves.

### PROCEDURE:

1. A non-chlorine based cleaner or mild detergent and warm water applied with a soft cloth or sponge to all contact surfaces.
2. Immediately rinse off cleaning agent(s), using clean warm water, clean soft cloth or sponge.
3. Dry with a soft clean cloth, removing standing water as soon as possible.

### NOTES:

1. Never use hydrochloric acid, wire brushes, steel wool, scrapers, or chlorine based cleaners on stainless steel surfaces, since they will break down the passivity layer and allow corrosion to occur.
2. On stainless steel surfaces, you may use a soft bristle brush or Scotch-Brite® pad for more stubborn stains. Always scrub with the direction of the grain. Follow with a thorough cleaning as described above.
3. Deposits from food preparation must be properly removed. Even hard water deposits will rust stainless steel, if not removed.
4. Repeated cleaning may dry up black-vinyl-clad steel (exterior) surfaces of the cooler. Armor All® or similar product can bring back the shine. Apply the product to a cloth and then rub into the surface, rather than spraying it directly onto the black-vinyl-clad surface.
5. The cooler door gaskets are most often overlooked when cleaning. Failure to clean them regularly will lead to premature failure, since alcohol and moisture build-up breaks down the gasket material.
6. A slide top cooler does not have an interior drain, so a large sponge is required for removing excess moisture from the interior after cleaning.

## ELECTRICAL AND REFRIGERATION SPECIFICATIONS

MODEL (L-to-R LENGTH)	ELECTRICAL	REFRIGERANT		DESIGN PRESSURE	
		TYPE	CHARGE	HIGH	LOW
24"	120V, 1Ph., 60 Hz., 5 Amp	R134a	7.5oz.	200	88
36"	120V, 1Ph., 60 Hz., 5 Amp	R134a	7.5oz.	200	88
48"	120V, 1Ph., 60 Hz., 8 Amp	R134a	16oz.	260	88
60"	120V, 1Ph., 60 Hz., 8 Amp	R134a	16oz.	300	125
72"	120V, 1Ph., 60 Hz., 8 Amp	R134a	16oz.	310	88
96"	120V, 1Ph., 60 Hz., 8 Amp	R134a	16oz.	310	88

# WIRING DIAGRAM FOR MODELS ST24 AND ST36

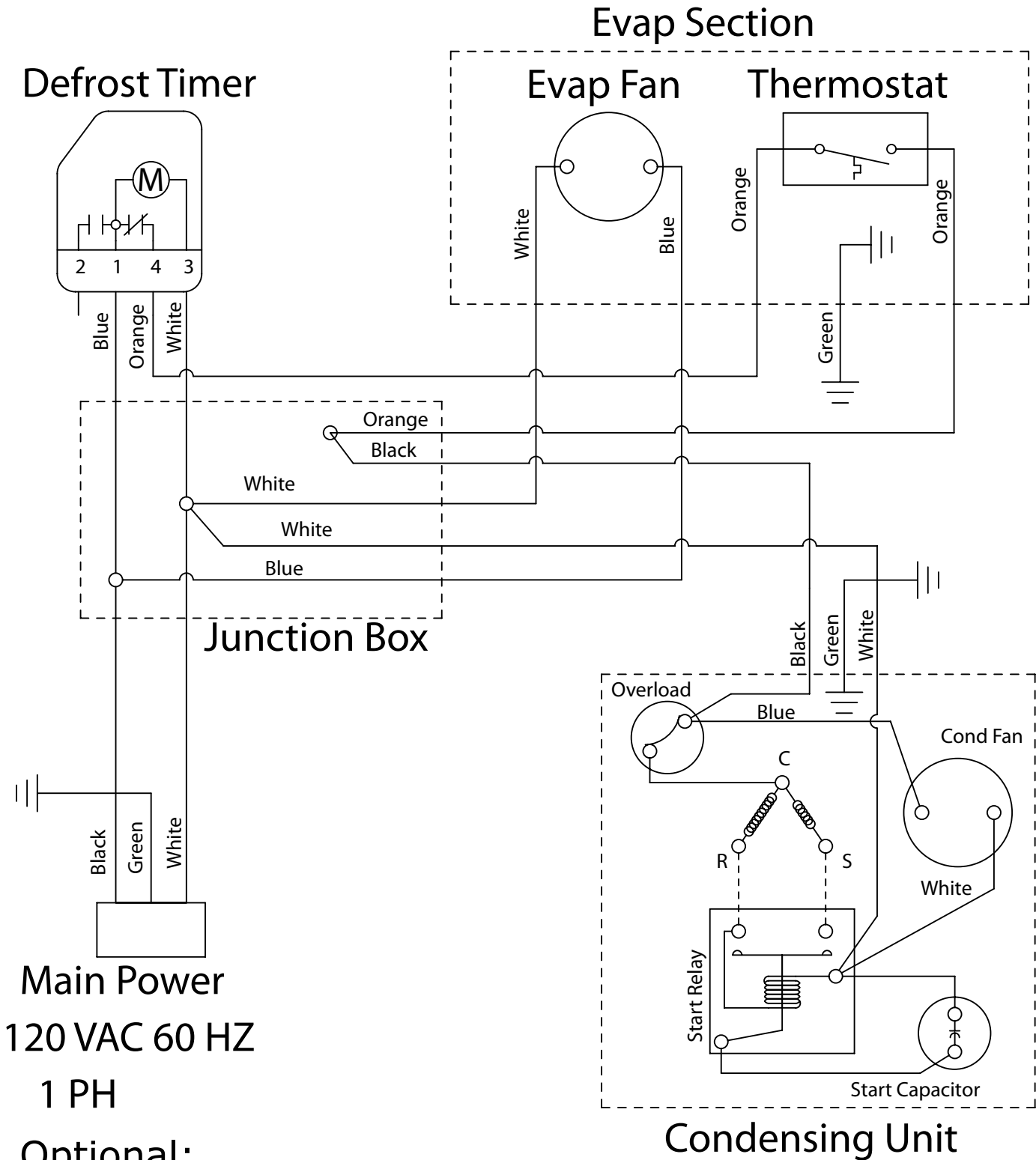

**Main Power**  
**120 VAC 60 HZ**  
**1 PH**  
**Optional:**  
**220 VAC 50 HZ**  
**1 PH**

# WIRING DIAGRAM FOR MODELS ST48, ST60, ST72, AND ST96

## Evap Section

### Defrost Timer

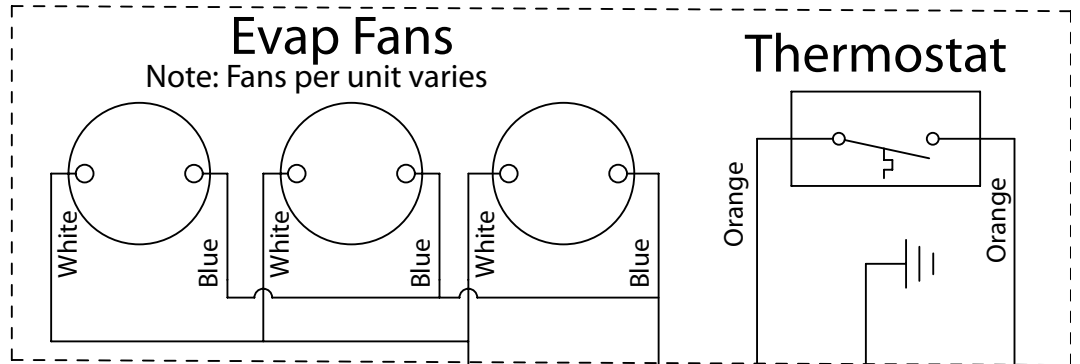
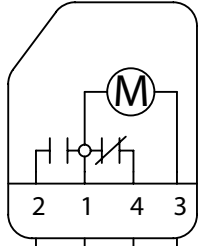

### Thermostat

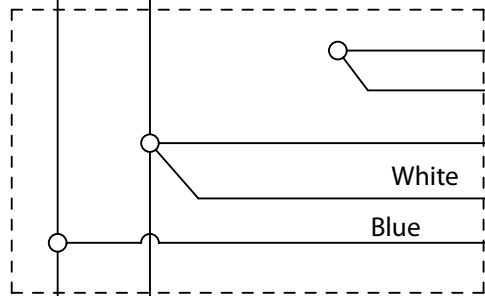
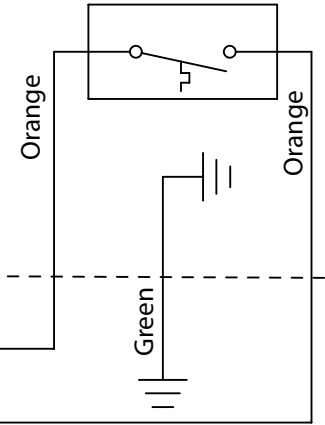

### Junction Box

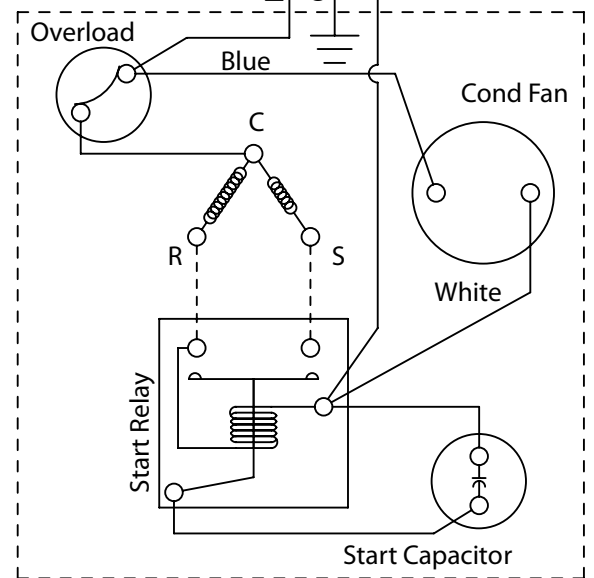

### Condensing Unit

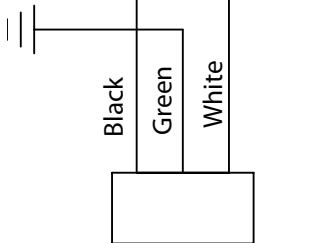

**Main Power**  
 120 VAC 60HZ  
 1 PH  
 Optional:  
 220 VAC 50 HZ  
 1 PH

# EVAPORATOR AND RELATED PARTS

<u>PART NO.</u>	<u>DESCRIPTION</u>	<u>PRICE</u>
1. 06004180	Bracket, evaporator fan motor	\$14.00
2. 06001383	Guard, evaporator fan	12.00
3. 09000298	Fan blade, evaporator, 5 blade, black	5.00
4. 06001445	Fan motor, evaporator	45.00
5. 06001405	Temperature control, includes knob	50.00
6. 08000079	Evaporator coil, ST24, ST36	180.00
08000077	Evaporator coil, ST48, ST60	285.00
08000080	Evaporator coil, ST72, ST96	390.00
7. 08000235	Cover, front, evaporator, stainless steel, ST24, ST36	85.00
08000096	Cover, front, evaporator, galvanized, ST24, ST36	66.00
08000242	Cover, front, evaporator, stainless steel, ST48	108.00
08000243	Cover, front, evaporator, galvanized, ST48	77.00
08000249	Cover, front, evaporator, stainless steel, ST60	132.00
08000250	Cover, front, evaporator, galvanized, ST60	100.00
08000255	Cover, front, evaporator, stainless steel, ST72	162.00
08000256	Cover, front, evaporator, galvanized, ST72	120.00
08000267	Cover, front, evaporator, stainless steel, ST96	210.00
08000268	Cover, front, evaporator, galvanized, ST96	170.00
8. 08000233	Housing and drain pan, evaporator, ST24, ST36	60.00
08000240	Housing and drain pan, evaporator, ST48	72.00
08000247	Housing and drain pan, evaporator, ST60	84.00
08000253	Housing and drain pan, evaporator, ST72	96.00
08000265	Housing and drain pan, evaporator, ST96	120.00
9. 06001345	Tubing, drain, clear plastic, 1/2" ID x 5/8" OD per foot	1.45
10. 06006096	TXV 1/8th Ton, 1/4 inlet, 3/8" outlet, ST48, ST60, ST72, ST96	135.00
11000121	Cap tube, 0.036 ID x 48", ST24, ST36	20.00
11. 08000275	Bracket, Evaporator, ST48, ST60	20.00

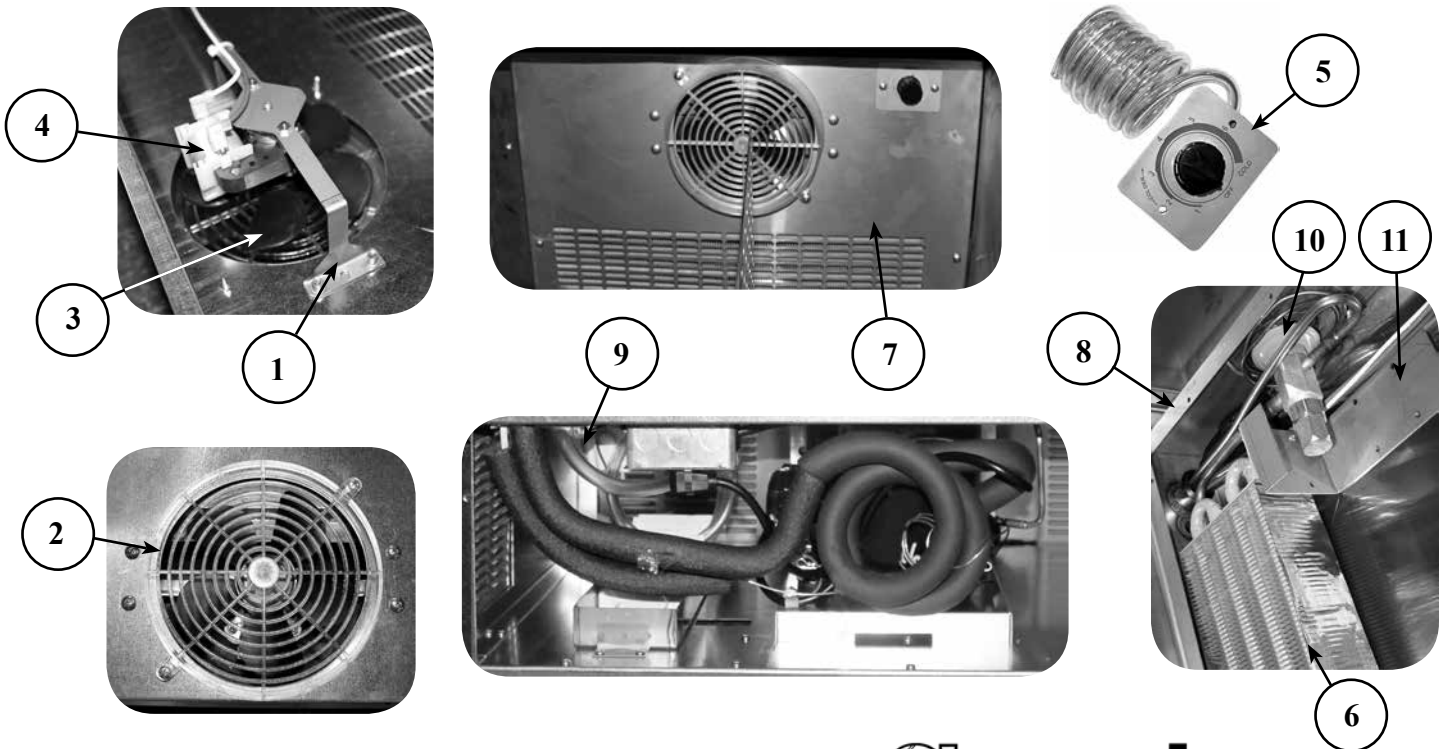

# COMPRESSOR AND CONDENSER RELATED PARTS

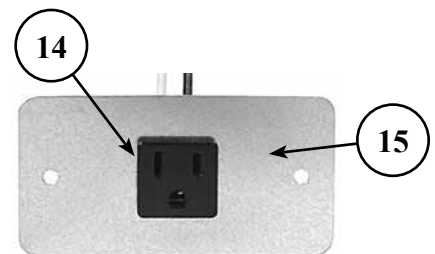
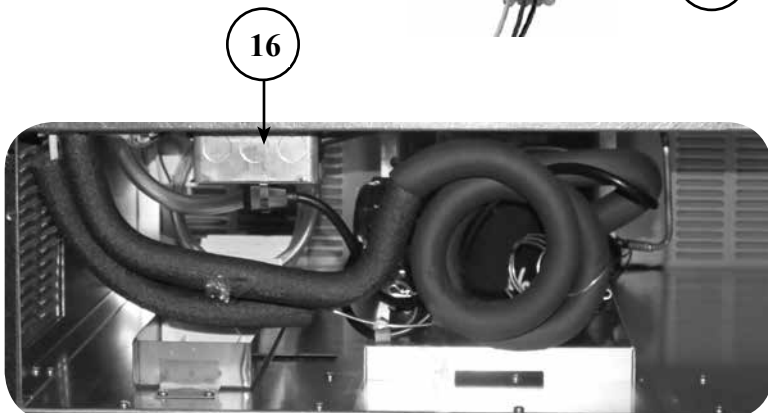
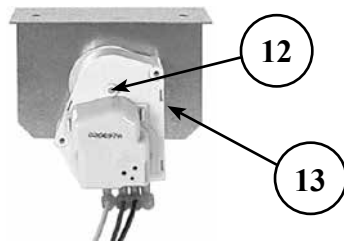
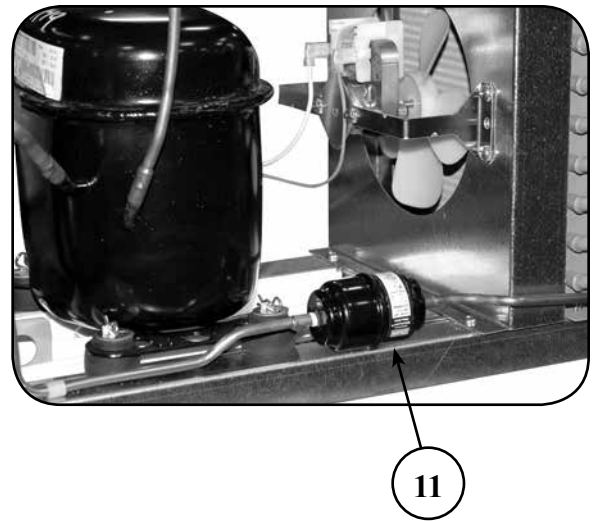
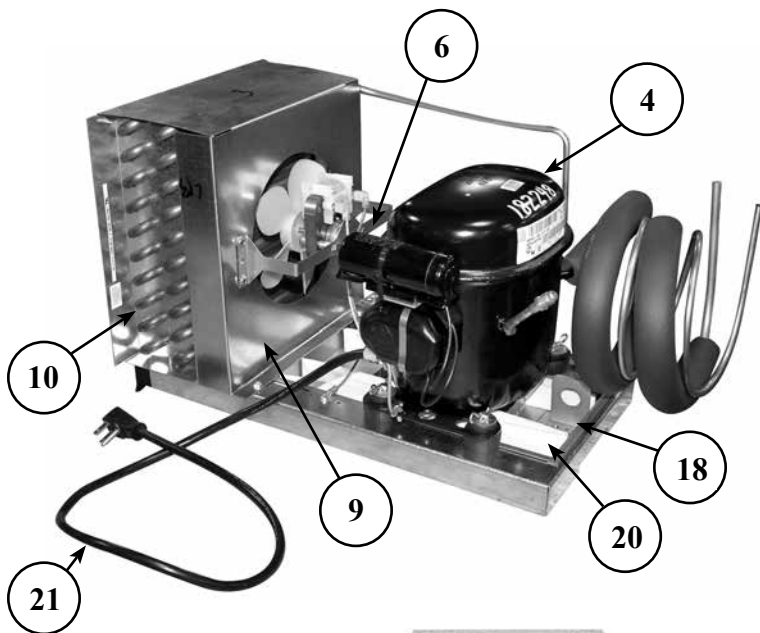
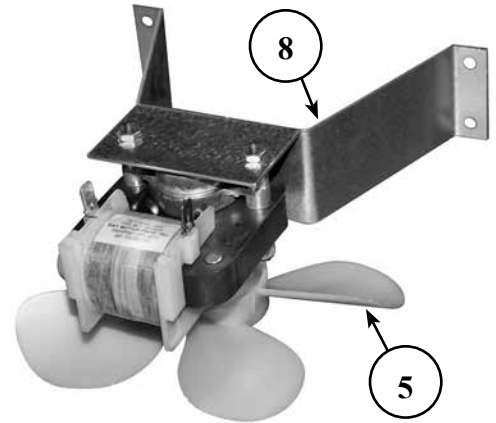
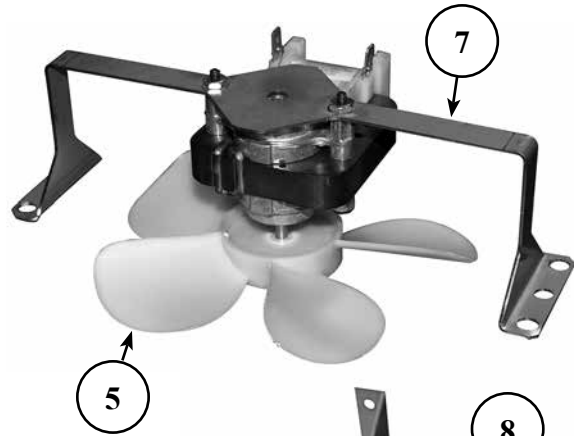
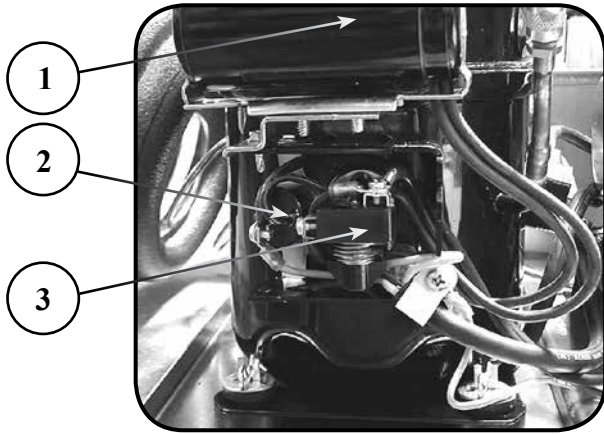

## COMPRESSOR AND CONDENSER RELATED PARTS

<u>PART NO.</u>	<u>DESCRIPTION</u>	<u>PRICE</u>
1. 06001382	Start capacitor, 1/4 HP Tecumseh	\$25.00
2. 06001303	Overload protector, 1/4 HP Tecumseh	25.00
08000259	Overload protector 1/8 HP Tecumseh	11.00
3. 04000243	Relay, 1/4 HP Tecumseh	18.00
08000260	Relay, 1/8 HP Tecumseh	18.00
4. 11000084	1/4 HP Tecumseh AEA4430YXA, ST48, ST60, ST72, ST96	415.00
08000234	1/8 HP Tecumseh AEA3417YXA, ST24, ST36	480.00
5. 06001395	Fan blade, condenser, 5 blade, white	5.00
6. 06001445	Motor, condenser fan, 120v	45.00
7. 06004180	Bracket, condenser fan motor mounting, ST48, ST60, ST72, ST96	14.00
8. 07000133	Bracket, condenser fan, ST24, ST36	20.00
9. 06006088	Fan shroud, condenser, ST48, ST60, ST72, ST96	20.00
08000232	Fan shroud, condenser, ST24, ST36	20.00
10. 06001393	Condenser coil, ST48, ST60, ST72, ST96	230.00
11000080	Condenser coil, ST24, ST36	225.00
11. 06001385	Filter dryer, 1/4" x 1/4"	20.00
12. 06001397	Defrost timer, automatic	32.00
13. 07000138	Bracket, automatic defrost timer mounting	3.00
00000051	Screw, automatic defrost timer mounting, #6 x 1/2" PPH, SMS, zinc	1.00
14. 06001409	Receptacle, compressor	5.00
15. 06000011	Cover, compressor receptacle mounting	10.00
00000030	Screw, electrical box, #10 x 1/2", PPH, zinc, drill kwik (2 required)	1.00 ea.
16. 00000168	Electrical box	4.00
06001552	Grommet, electrical box (2 required)	3.50 ea.
17. 08000125	Pan, condensate, ST24, ST36	60.00
18. 06000155	Pan, condensate, ST48, ST60, ST72, ST96	48.00
19. 08000128	Wicking material, consists of 20 4" pieces, ST24, ST36	32.00
20. 08000129	Wicking material, consists of 5 11" pieces, ST48, ST60. ST72, ST96	50.00
21. 06001313	Power cord, condensing unit	20.00
22. 06009527	Power cord, exterior, 132" long	35.00

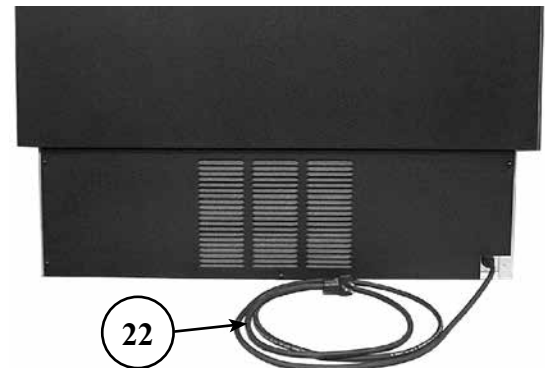
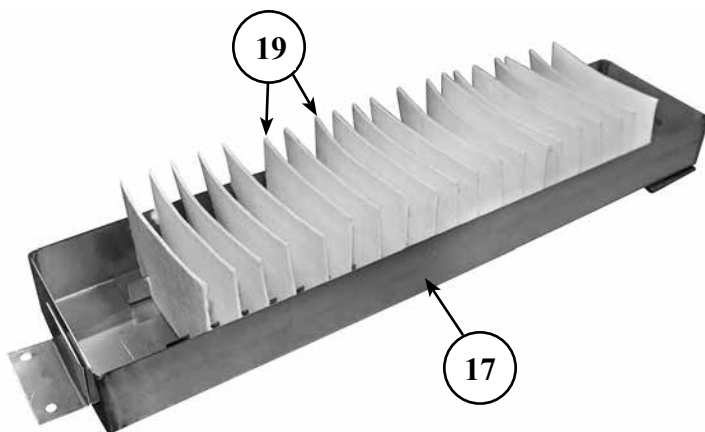

Rear view of ST36

# REFRIGERATION COMPARTMENT COVERS

Left Side from rear

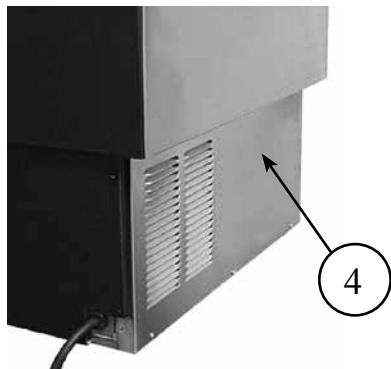

Right Side from rear

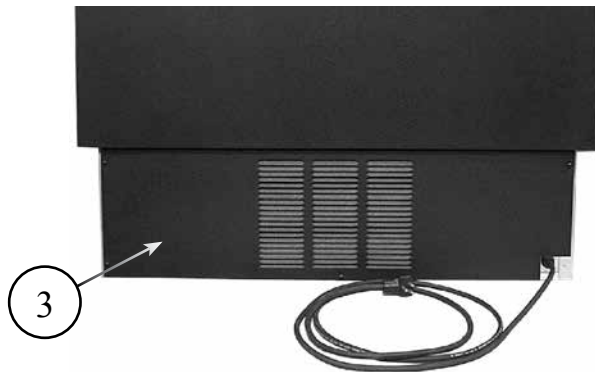
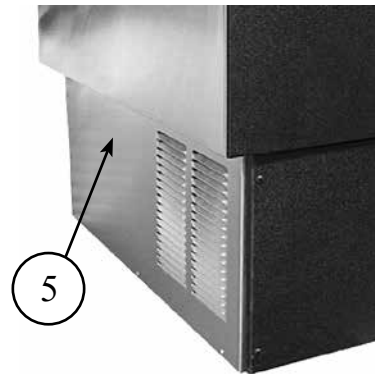

Models ST24, ST36

Rear view

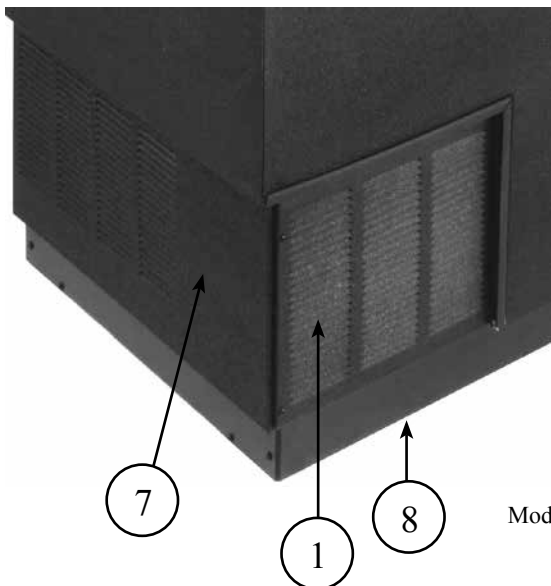

Models ST48, ST60, ST72, and ST96

Front view

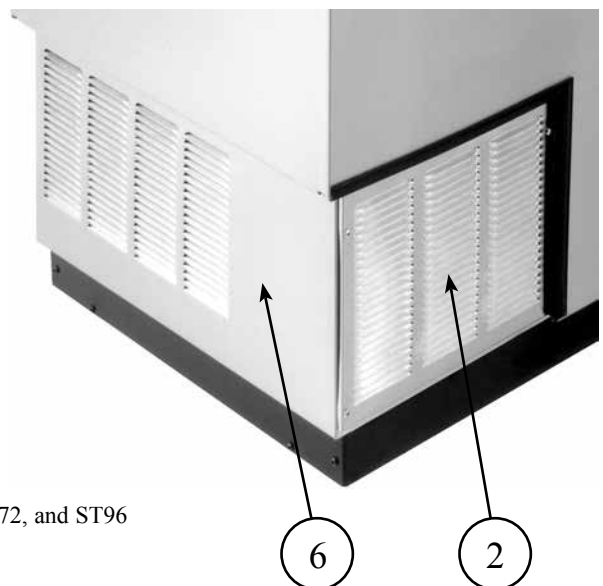

## REFRIGERATION COMPARTMENT COVERS

<u>PART NO.</u>	<u>DESCRIPTION</u>	<u>PRICE</u>
07000202	Grill, front, black clad vinyl, ST24	\$50.00
07000203	Cover, front, stainless steel, ST24	80.00
08000100	Cover, front, black clad vinyl, ST36	60.00
08000101	Cover, front, stainless steel, ST36	100.00
1. 08000102	Cover, front or back, black clad vinyl, ST48, ST60, ST72, ST96	50.00
2. 08000103	Cover, front or back, stainless steel, ST48, ST60, ST72, ST96	100.00
3. 07000773	Back, black clad vinyl, ST24	50.00
07000774	Back, stainless steel, ST24	80.00
07000775	Back, black clad vinyl, ST36	60.00
07000776	Back, stainless steel, ST36	100.00
07000779	Side, left, black clad vinyl, ST24, ST36	50.00
4. 07000780	Side, left, stainless steel, ST24, ST36	80.00
07000781	Side, right, black clad vinyl, ST24, ST36	50.00
5. 07000782	Side, right, stainless steel, ST24, ST36	80.00
6. 08000367	Side, left, stainless steel, ST48, ST60, ST72, ST96	80.00
7. 08000366	Side, left, black vinyl, ST48, ST60, ST72, ST96	50.00
8. 08000119	Pan, condensate, ST48, ST60, ST72, ST96	115.00

## SHELVING AND RELATED PARTS

<u>PART NO.</u>	<u>DESCRIPTION</u>	<u>PRICE</u>
1. 08000071	Bracket, 28" divider rack, ST48 (2 required)	\$20.00 ea.
08000137	Bracket, 40" divider rack, ST60 (2 required)	26.00 ea.
08000072	Bracket, 52" divider rack, ST72 (2 required)	30.00 ea.
08000073	Bracket, 76" divider rack, ST96 (2 required)	40.00 ea.
00000031	Screw, bracket mounting, #10 x 1/2" PPH, SS, SMS	1.00
2. 08000082	Rack, divider, chrome, ST48, ST60, ST72, ST96	47.00
3. 08000114	Divider wall, stainless steel, ST24, ST36	60.00
08000115	Divider wall, galvanized, ST24, ST36	41.00

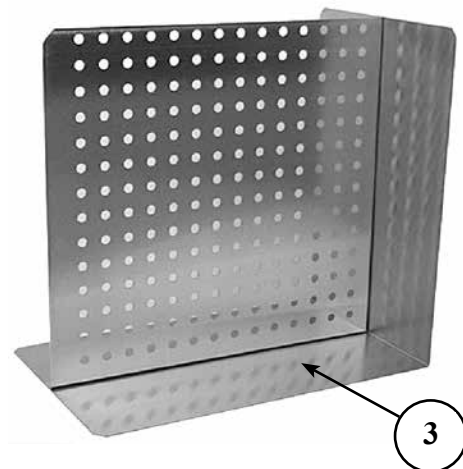
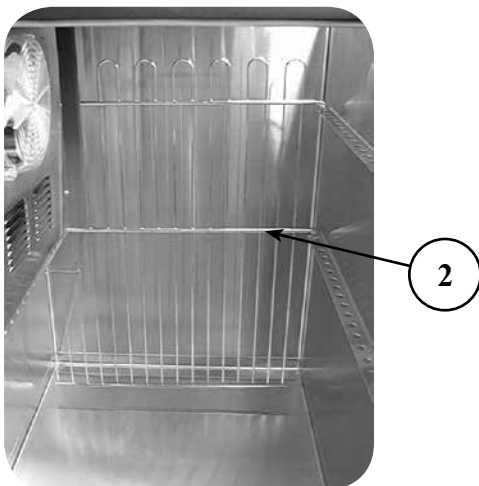

## DOORS, TOPS, AND RELATED PARTS

PART NO.	DESCRIPTION	PRICE
1. 07000129	Gasket, wiper, 24" top 21-1/2" long	\$10.00
07000130	Gasket, wiper, 36" top 33-1/2" long	14.00
08000107	Sliding door, locking, 20-3/16", ST24	180.00
08000108	Sliding door, locking, 32-3/16", ST36	240.00
08000106	Sliding door, locking, ST24, ST48, ST72, ST96 (pre 2000)	180.00
08000109	Sliding door, locking, ST36 (pre 2000)	240.00
07000213	Sliding door, 20-3/16", ST24	126.00
2. 07000214	Sliding door, 32-3/16", ST36	192.00
08000225	Key, CH751 for slide top cooler lock	4.00
3. 07000231	Top, ST24	126.00
07000232	Top, ST36	192.00
07000233	Top, ST48	252.00
08000184	Top, ST60	360.00
08000120	Top, ST72	384.00
08000121	Top, ST96	510.00
4. 07000250	Breaker strip, 24" sliding locking door opening, 4 pieces	70.00
07000251	Breaker strip, 36" sliding locking door opening, 4 pieces	80.00
07000238	Breaker strip, 24" sliding door opening, 4 pieces	25.00
07000239	Breaker strip, 36" sliding door opening, 4 pieces	35.00



## 220 VOLT ELECTRICAL PARTS

<u>PART NO.</u>	<u>DESCRIPTION</u>	<u>PRICE</u>
06006103	Compressor, 1/4 HP, 220V, 50-60Hz, R134a, ST48, ST60, ST72, ST96	\$665.00
06006174	Start capacitor, 1/4 HP, 220V, 50-60Hz, ST48, ST60, ST72, ST96	15.00
06006175	Relay, 1/4 HP, 220V, 50-60Hz, ST48, ST60, ST72, ST96	15.00
06006176	Overload, 1/4 HP, 220V, 50-60Hz, ST48, ST60, ST72, ST96	17.00
08000261	Compressor, 1/8 HP, 220V, 50-60Hz, R134a, ST24, ST36	700.00
08000262	Overload protector, 1/8 HP, 220V, 50-60Hz, ST24, ST36	15.00
08000263	Relay, 1/8 HP, 220V, 50-60Hz, ST24, ST36	18.00
06001448	Motor, evaporator/condenser fan, 220V, 50-60Hz	57.00
06001398	Defrost timer, automatic, 220V, 50-60Hz	43.00

## ELECTRICAL COMPONENTS

<u>PART NO.</u>	<u>DESCRIPTION</u>	<u>PRICE</u>
06006121	Replacement powercord assembly, includes (06001572, 06009527)	\$40.00

## LIGHT KITS

<u>PART NO.</u>	<u>DESCRIPTION</u>	<u>PRICE</u>
1. STLK-1	Light kit, ST48, ST60 - NO LONGER AVAILABLE	
STLK-2	Light kit, ST72, ST96 - NO LONGER AVAILABLE	

