

Sno-Konette

Instruction Manual

Deluxe – Model #1002S, 1002-01-100
Standard – Model #1003S, 1003SX
DC Model #1009S





 **GOLD MEDAL**®



FUNFOOD EQUIPMENT & SUPPLIES



Cincinnati, OH 45241-4807 USA



SAFETY PRECAUTIONS



	 DANGER
	<p>Machine must be properly grounded to prevent electrical shock to personnel. Failure to do so could result in serious injury, or death. DO NOT immerse any part of this equipment in water. DO NOT use excessive water when cleaning. Keep cord and plug off the ground and away from moisture. Always unplug the equipment before cleaning or servicing. Make sure all machine switches are in the OFF position before plugging the equipment into the receptacle.</p> <p style="text-align: right; font-size: small;">008_051514</p>

	 DANGER
	<p>Improper installation, adjustment, alteration, service, or maintenance can cause property damage, injury, or death. Any alterations to this equipment will void the warranty and may cause a dangerous condition. NEVER make alterations to this equipment. Read the Installation, Operating, and Maintenance Instructions thoroughly before installing, servicing, or operating this equipment.</p> <p style="text-align: right; font-size: small;">014_051514</p>

	 WARNING
	<p>This machinery contains sharp blades. Keep hands and body parts clear at all times.</p> <p style="text-align: right; font-size: small;">037_103114</p>



	 WARNING
	<p>NEVER put your fingers into the shaver body (the goose-neck, ice chute, or hopper). Serious injury may occur.</p> <p style="text-align: right; font-size: small;">017_103114</p>



	 WARNING
	<p>ALWAYS wear safety glasses when servicing this equipment.</p> <p style="text-align: right; font-size: small;">010_010914</p>

	 WARNING
	<p>No user serviceable parts inside. Refer servicing to qualified service personnel.</p> <p style="text-align: right; font-size: small;">011_051514</p>

SAFETY PRECAUTIONS (continued)

	 WARNING
	<p>Read and understand operator's manual and all other safety instructions before using this equipment. To order copies of the operator's manual go to gmpopcorn.com or write to Gold Medal Products Co., 10700 Medallion Drive, Cincinnati, OH 45241 USA 1-(800)-543-0862</p> <p style="text-align: right; font-size: small;">022_060215</p>

	 WARNING
	<p>DO NOT allow direct contact of this equipment by the public when used in food service locations. Only personnel trained and experienced in the equipment operation may operate this equipment. Carefully read all instructions before operation.</p> <p style="text-align: right; font-size: small;">012_010914</p>

	 WARNING
	<p>This machine is NOT to be operated by minors.</p> <p style="text-align: right; font-size: small;">007_010914</p>

Note: Improvements are always being made to Gold Medal's equipment. This information may not be the latest available for your purposes. It is critical that you call Gold Medal's Technical Service Department at 1-800-543-0862 for any questions about your machine operations, replacement parts, or any service questions. (Gold Medal Products Co. does not assume any liability for injury due to careless handling and/or reckless operation of this equipment.)

Installation Instructions

Inspection of Shipment

After unpacking, check thoroughly for any damage which may have occurred in transit. Claims should be filed immediately with the transportation company. The warranty does not cover damage that occurs in transit, or damage caused by abuse, or consequential damage due to the operation of this machine, since it is beyond our control (reference warranty in back of manual).

Manual

Read and understand the operator's manual and all other safety instructions before using this equipment. To order copies of the operator's manual go to gmpopcorn.com or write to Gold Medal Products Co., 10700 Medallion Drive, Cincinnati, OH 45241 USA 1-(800)-543-0862.

Items Included with this Unit

- Drain Hose

Setup

This unit has been tested at the factory.

1. Remove all packaging and tape prior to operation.
2. Place unit on a sturdy, level base which can withstand accidental dripping of water and ice.
3. Locate the pusher handle (packed in a separate box). Connect the pusher handle to the shaver body using the bolt and nut provided.
4. Connect the drain hose to funnel excess water to floor drain or basin tub. Drained water is not intended for human consumption.
5. After setup, the unit should be cleaned prior to use (see Care and Cleaning section of this manual).



Electrical Requirements

The following power supply must be provided for:

1009S: 12 Volts DC - Customer must supply 12 volt battery for proper machine operation.
Make sure to follow all safety precautions provided by the battery manufacturer.
Cables must be attached to the proper polarity.

The following power supply must be provided for:



1002S, 1003S: 120 V~, 972 W, 60 Hz
1002-01-100, 1003SX: 230 V~, 972 W, 50 Hz

	 DANGER
	<p>Machine must be properly grounded to prevent electrical shock to personnel. Failure to do so could result in serious injury, or death. DO NOT immerse any part of this equipment in water. DO NOT use excessive water when cleaning. Keep cord and plug off the ground and away from moisture. Always unplug the equipment before cleaning or servicing. Make sure all machine switches are in the OFF position before plugging the equipment into the receptacle.</p> <p style="text-align: right; font-size: small;">008_051514</p>

A certified electrician must furnish sufficient power for proper machine operation and install any supplied receptacle. We recommend this equipment be on a dedicated and protected circuit. Failure to wire properly will void the warranty and may result in damage to the machine. It is Gold Medal Products Co.'s recommendation that this machine be plugged directly into a wall outlet. The use of extension cords is not recommended due to safety concerns, and may cause sacrificed and/or reduced performance. Make sure cord is located to prevent a trip hazard or unit upset.

Before You Plug In Machine

1. Make sure all machine switches are in the OFF position before plugging the equipment into the receptacle.
2. Make sure the wall outlet can accept the grounded plugs (where applicable) on the power supply cord.
3. The wall outlet must have the proper polarity. If in doubt, have a competent electrician inspect the outlet and correct if necessary.
4. **DO NOT** use a grounded to un-grounded receptacle adapter (where applicable).
5. Install the unit in a level position.

	 CAUTION
	<p>If the supply cord is damaged, it must be replaced by Gold Medal Products Co., its service agent or similarly qualified persons in order to avoid a hazard.</p> <p style="text-align: right; font-size: small;">039_080614</p>

Operating Instructions

To Operate the Sno-Konette:

1. Fill the hopper to within an inch from the top with ice cubes or block ice (no larger than 3 to 4 inches). The larger the pieces, the better the snow.
2. Switch the motor on, and wait for it to reach full speed (this will take a minute or so).
3. Press the pusher handle down against the ice in the hopper. Apply firm and even pressure to make the best snow. Practice will enable you to gauge when to stop. This allows the ice to resettle against the shaver head. You may find that you need to relieve the pressure two or three times during a cycle. Too much pressure will result in snow that is coarse; too little pressure will make the snow mushy.

NOTE: Never allow any foreign or metallic objects around the shaver area of the Sno-Konette. Ice picks, scoops, and debris that may be in the ice often damage blades.

Ice Requirements:

The Sno-Konette can take ice cubes or block ice, if you break the block into pieces approximately 3 to 4 inches in size.

NOTE: The ice will not enter the shaving chute if the pieces are too large.

Care and Cleaning

	⚠ DANGER
	Machine must be properly grounded to prevent electrical shock to personnel. DO NOT immerse in water. Always unplug the equipment before cleaning or servicing. <small>025_020314</small>

	⚠ WARNING
	This machinery contains sharp blades. Keep hands and body parts clear at all times. <small>037_103114</small>

Good sanitation practice demands that all food preparation equipment be cleaned regularly (only use non-toxic, food grade cleaners). A clean looking, well-kept machine is one of the best ways of advertising your product.



Follow the directions below to clean and sanitize the unit after each day of use.



1. With the machine OFF, unplug the unit before attempting to clean.
2. Empty water from pans and clean using appropriate cleaners for the type of machine; review all manufacturer's instructions and warnings on cleaning product prior to use.



DO NOT use oven cleaners or abrasive materials as they will damage parts of the machine.



DO NOT use Ammonia cleaners, they will damage plastic panels.

MAINTENANCE INSTRUCTIONS

	 DANGER
	<p>Machine must be properly grounded to prevent electrical shock to personnel. Failure to do so could result in serious injury, or death. DO NOT immerse any part of this equipment in water. DO NOT use excessive water when cleaning. Keep cord and plug off the ground and away from moisture. Always unplug the equipment before cleaning or servicing. Make sure all machine switches are in the OFF position before plugging the equipment into the receptacle.</p> <p style="text-align: right;">008_051514</p>

	 DANGER
	<p>Improper installation, adjustment, alteration, service, or maintenance can cause property damage, injury, or death. Any alterations to this equipment will void the warranty and may cause a dangerous condition. NEVER make alterations to this equipment. Read the Installation, Operating, and Maintenance Instructions thoroughly before installing, servicing, or operating this equipment.</p> <p style="text-align: right;">014_051514</p>

	 WARNING
	<p>No user serviceable parts inside. Refer servicing to qualified service personnel.</p> <p style="text-align: right;">011_051514</p>

	 CAUTION
	<p>THE FOLLOWING SECTIONS OF THIS MANUAL ARE INTENDED ONLY FOR QUALIFIED SERVICE PERSONNEL WHO ARE FAMILIAR WITH ELECTRICAL EQUIPMENT. THESE ARE NOT INTENDED FOR THE OPERATOR.</p> <p style="text-align: right;">027_010914</p>

Installing New Shaver Blades

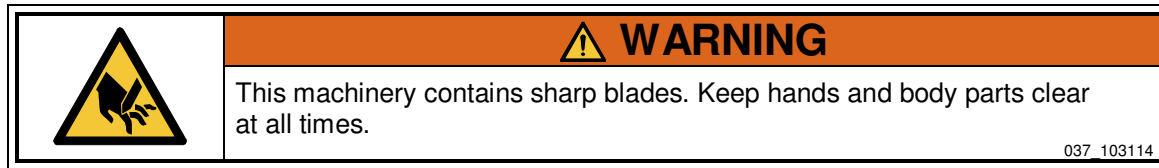

The section describes the procedure to replace the shaver blades. ALWAYS turn the machine OFF and unplug unit from the power supply prior to blade inspection or replacement. Use a flashlight to examine the blades in the shaver body. If the blades appear to be nicked or bent, then the blades should be replaced.

Blade Replacement

1. With the machine OFF, unplug the unit from the power supply.
2. Remove motor cover (keep all fasteners as they will be used to reinstall the cover).
3. Use a permanent marker and put a guide mark on the motor shaft where the shaver head stops; also place a small guide mark on the cabinet where the motor sets (reference shaver cut away view on next page).
4. To remove the shaver head from the motor shaft, loosen the motor mounting bolts. (If unit has a hopper support and guide, it must also be removed).
5. Pull motor back until the (2) Allen head set screws on the shaver head are visible. Loosen the (2) set screws (do not remove set screws).
6. Carefully guide the shaver head off of the motor shaft and through the hopper. If the shaver head is frozen to the shaft, pull the motor back trapping the shaver head against the inside of the hopper, until the shaver head disengages.
7. After removing the shaver head, check the motor shaft for burrs and corrosion (use a fine tooth file to remove any burrs or corrosion).
8. Remove blades from shaver head. Replace old blades with a new set (blades may be re-sharpened).
9. Position new blades on shaver head and insert blade mounting screws until finger tight.
10. Set the blade thickness to 1/32" using a height gauge (thickness of a dime), reference Set Blade Height illustration shown on next page. Make sure the blade height is even across the shaver head.
11. Tighten the blade mounting screws completely. Check the blade height again to ensure the blades did not move while tightening the screws.
12. Carefully guide the shaver head through the hopper and back onto the motor shaft; realign head with guide mark made on the shaft in Step 3 above. (The pusher handle may be used to help press the shaver head onto the shaft.)

13. The shaver head set screws must be on the flat side of the motor shaft. Once aligned, fasten set screws securely.
14. Adjust the motor to realign with guide mark made on the cabinet in Step 3, then refasten motor mounting bolts (if unit has a hopper support and guide, it must also be reinstalled). Check the shaver head to make sure it is not rubbing against the back of the hopper and the blades are not touching the pusher handle or sides of hopper; adjust as needed.
Note: Replace any shims that were between the motor base and the mounting surface.
15. Reinstall motor cover.

Cut Away View of Shaver Head on Motor Shaft

General shaver image shown for reference only (models may vary).

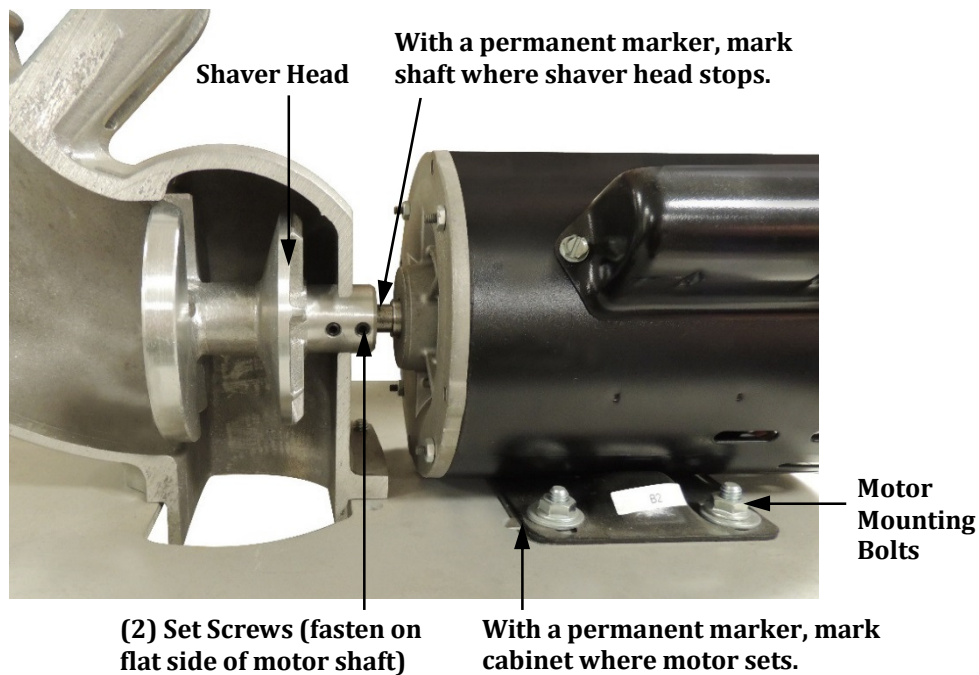

Set Blade Height

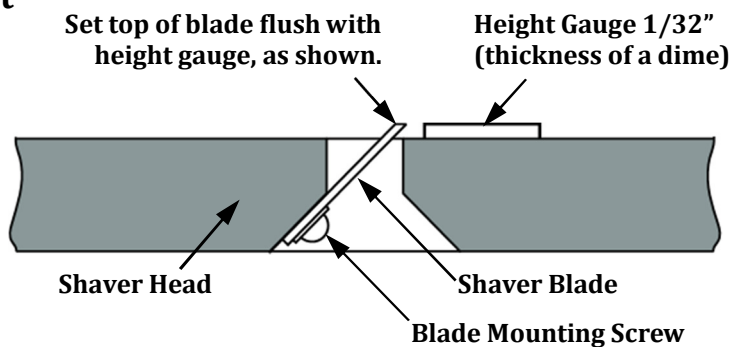

ORDERING SPARE PARTS

1. Identify the needed part by checking it against the photos, illustrations, and/or parts list.
2. Use only approved replacement parts when servicing this unit.
3. When ordering, please include part number, part name, and quantity needed.
4. Please include your model number, serial number, and date of manufacture (located on the machine nameplate/data plate) with your order.
5. Address all parts orders to:

Parts Department
Gold Medal Products Co.
10700 Medallion Drive
Cincinnati, Ohio 45241-4807

Or, place orders by phone or online:

Phone: (800) 543-0862
(513) 769-7676
Fax: (800) 542-1496
(513) 769-8500
E-mail: info@gmpopcorn.com
Web Page: gmpopcorn.com

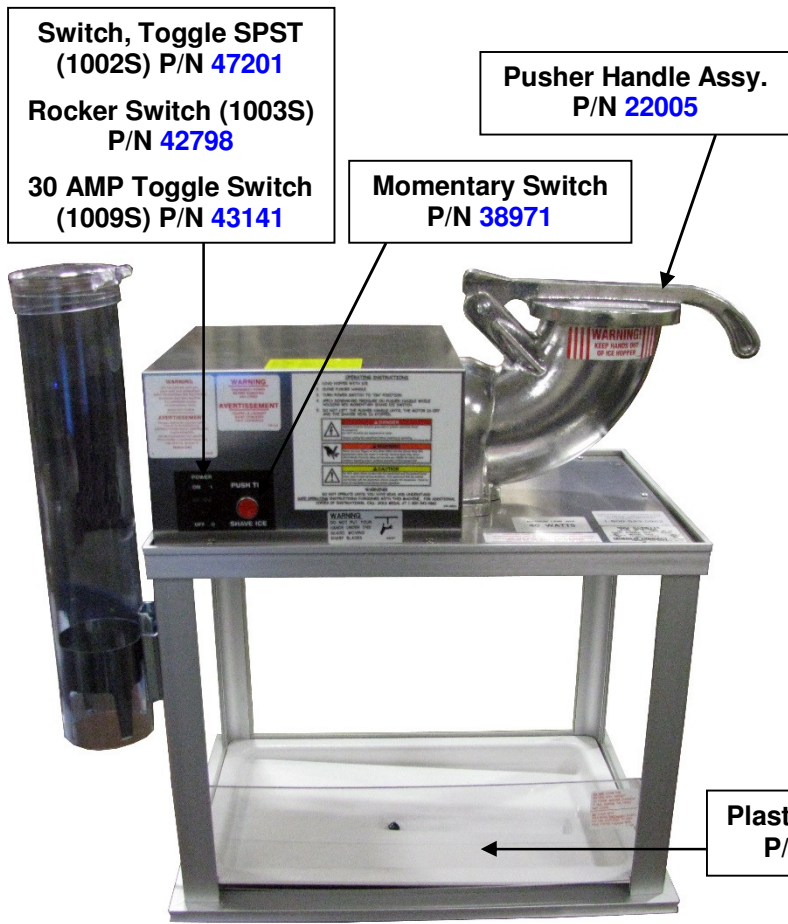

View of DC Model 1009S

Lamp Holder
P/N 49837
(Models 1003S &
1003SX Only)

Bulb
P/N 87065
(1003S Only)

Export Model
1003SX Bulb
P/N 87444

Motor P/N 55448
(Export Motor,
P/N 39022EX)

Model 1009S
12V DC Motor
P/N 22041

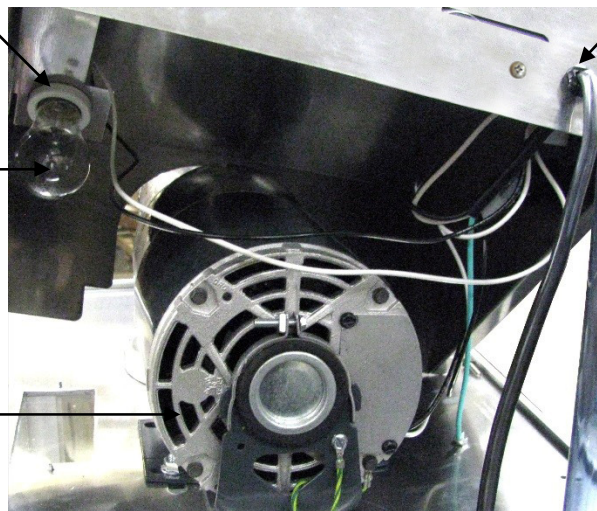

Strain Relief
P/N 87810
Model 1009S
P/N 89045

Lead-in Power Cord
P/N 22038
(Export Power Cord
P/N 42369)

Model 1009S
Power Supply Cord
Assembly P/N 22043

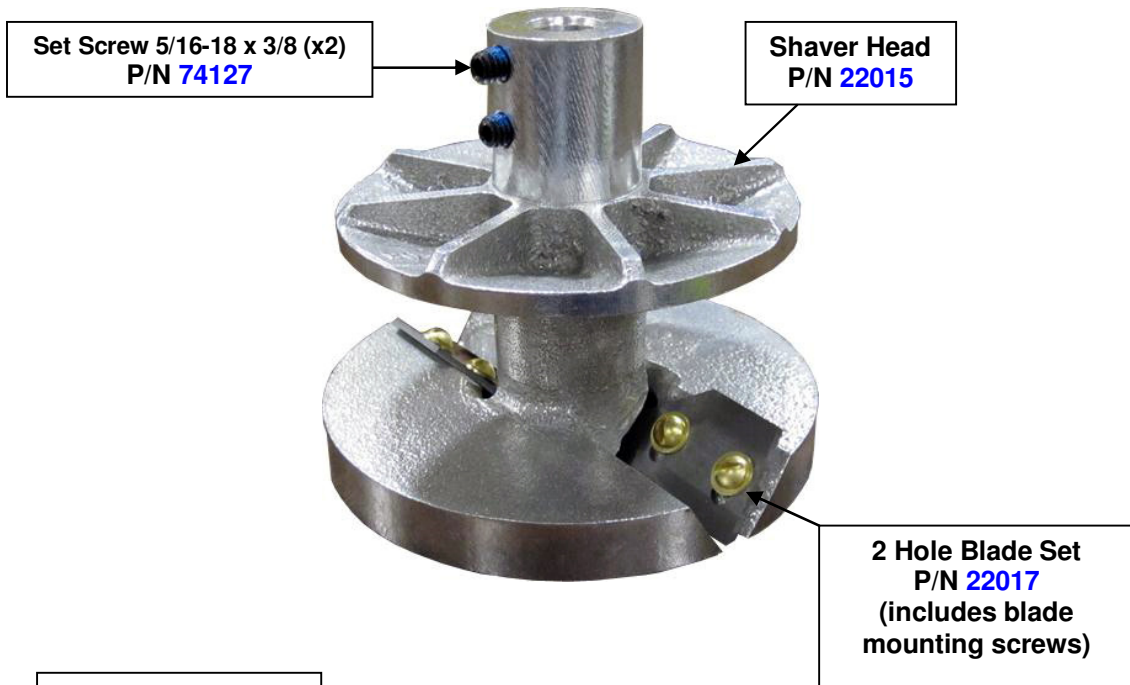

Drain Pan, Counter
P/N 12061

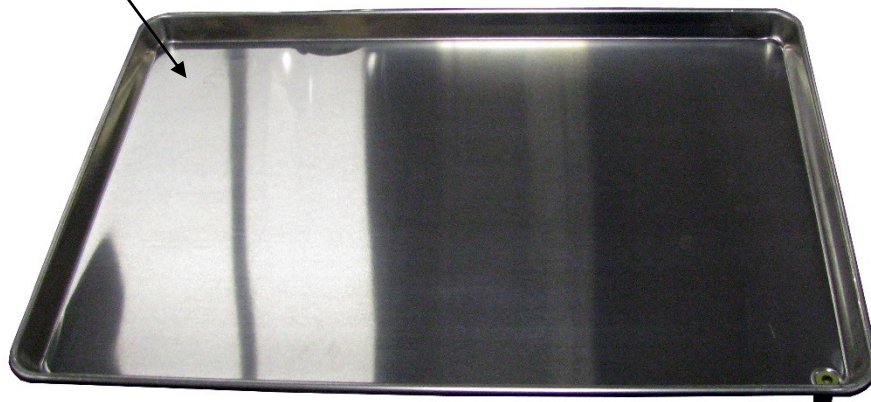

Ice Scoop P/N 39068



Snow Dipper P/N 1088

PARTS LIST

Model # 1002S Part No.	Model # 1002-01-100 Part No.	Model # 1003S Part No.	Model # 1003SX Part No.	Model # 1009S Part No.	Description
47201	47201	42798	42798		Rocker Switch Switch
				43141	30 AMP TOGGLE SWITCH
		13140		13015	ROCKER SW. LABEL ON/OFF
1088	1088	1088	1088	1088	6 oz Sno Dipper
39018	39018	39018	39018	39018	6 oz. Cup Dispenser with Bracket
39068	39068	39068	39068	39068	Ice Scoop
22228	22228	61115	61115		Dome Assy (1002S) or Motor Cover Assy (1003S)
22222	22222				Dome Sign (Glass) for 1002S
41020					Light Tube Holder
41021					Light Tube Holder Starter
41022					Light Ballast
41023					Light Starter
41057					Light Tube
	55379				LED Strip Cool White
	55394				Power Supply 24VDC 20W
		49837	49837		Lamp Holder
		87065	87444		40 Watt Light Bulb
		61112	61112		Light Cover (Clear Plastic)
47010	47010	47010	47010		Label, "Safe Operating Instructions"
47155	47155	47155	47155	47155	Rubber Feet (4 Req)
49132	49132	49132	49132	49132	Grip Nut (5/16-8; Motor Mounting; 4)
74119	74119	74119	74119		Label, "Warning Disconnect Power"
41163	41163	41163	41163	41163	Hose Clamp with Screw
77747	77747	77747	77747	77747	Slot Head Hex Screw (#8-32 x 3/4") cabinet
12018	12018	12018	12018	12018	Blade Mounting Screw (8-32 x 3/8" Brass)
		12480	12480	12480	Decal
12061	12061	12061	12061	12061	DRAIN PAN, COUNTER
12156	12156	12156	12156	12156	3 ft. Tubing
12038	12038	12038	12038	12038	Front Glass (15" x 18")
12039	12039	12039	12039	12039	Side Glass (15" x 11 15/16")
40567	40567	40567	40567	40567	GLASS CHAN 11 1/2 (for glass side panels)
42651	42651	42651	42651	42651	GLASS CHAN 18 1/16 (for glass front panel)
49214	49214	49214	49214	49214	GLASS CHAN 15 1/8 (for side edges of all glass panels)
				22037	CIRCUIT BREAKER 40 AMP
55448		55448			1/4 HP MOTOR
	39022EX		39022EX		MOTOR, 1/3 HP 60/50 HZ
				22041	12 VOLT DC MOTOR

ELECTRICAL SCHEMATIC – MODEL #1002S

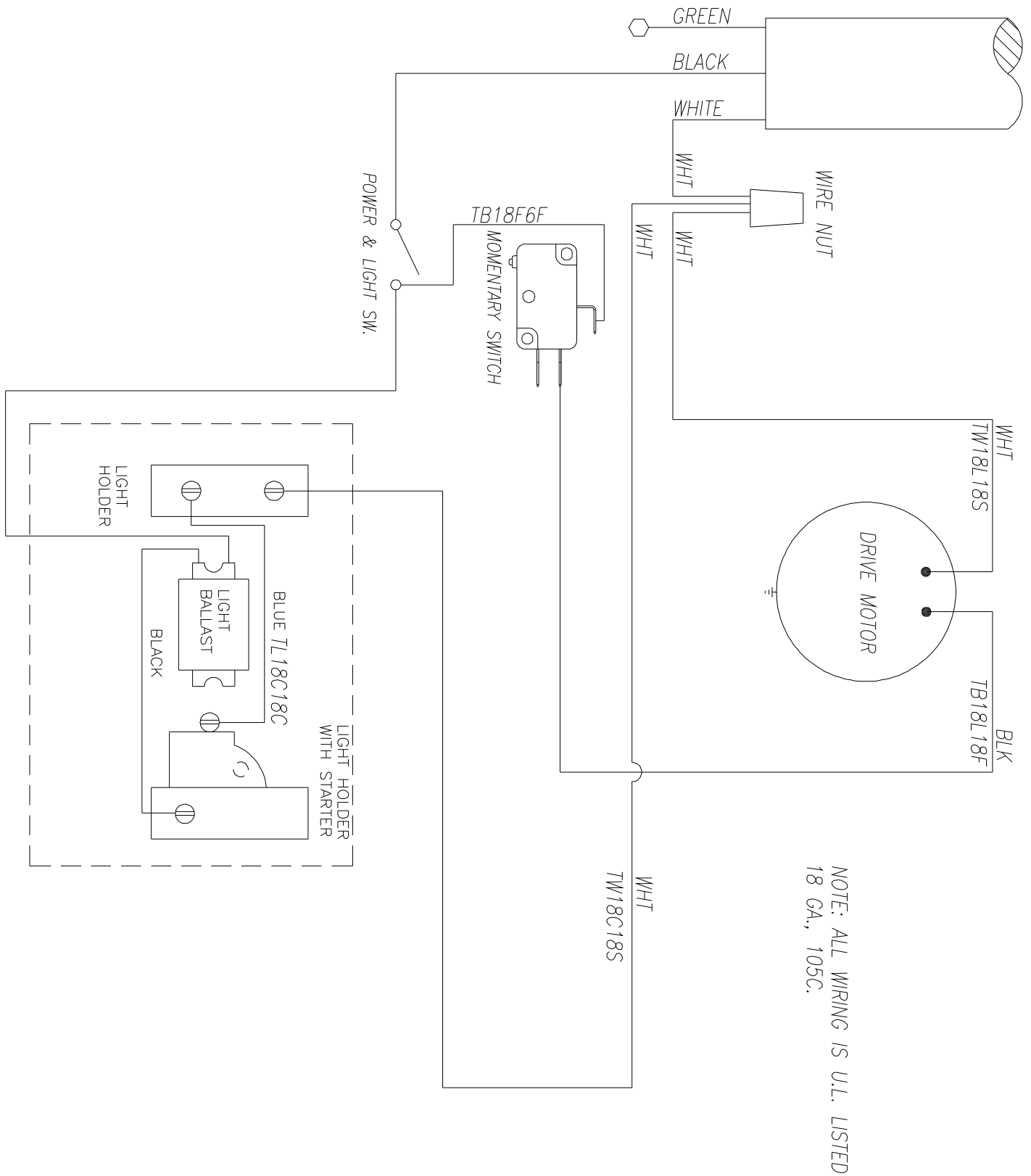

ELECTRICAL SCHEMATIC – MODEL #1003S

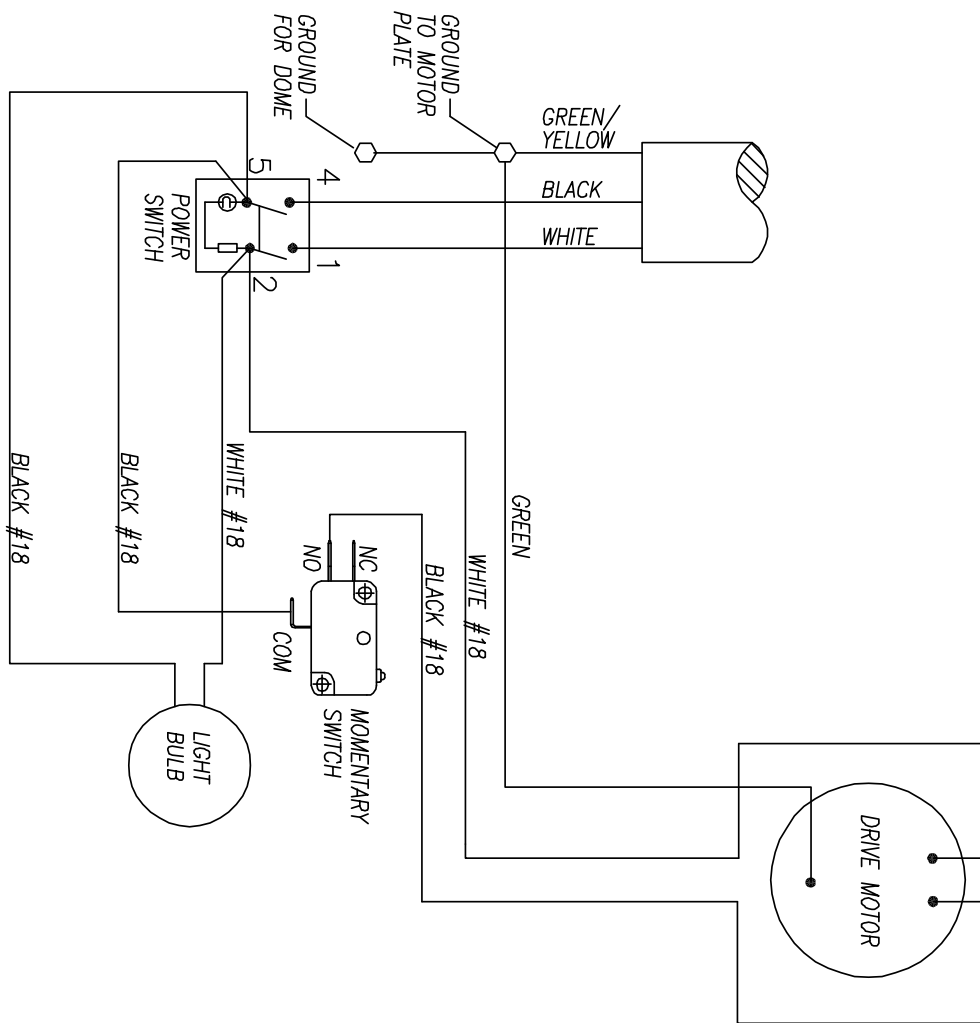

NOTE: ALL WIRING IS U.L. LISTED
18 GA., 105C.

NOTE:
1. CONFIRM MOTOR ROTATION, MOTOR MUST ROTATE COUNTER CLOCKWISE (CCW) WHEN VIEWED FROM THE SHAFT END OF THE MOTOR.
REFER TO MOTOR DATA PLATE FOR PROPER INTERNAL MOTOR WIRING CONNECTIONS.

ELECTRICAL SCHEMATIC – MODEL #1003SX

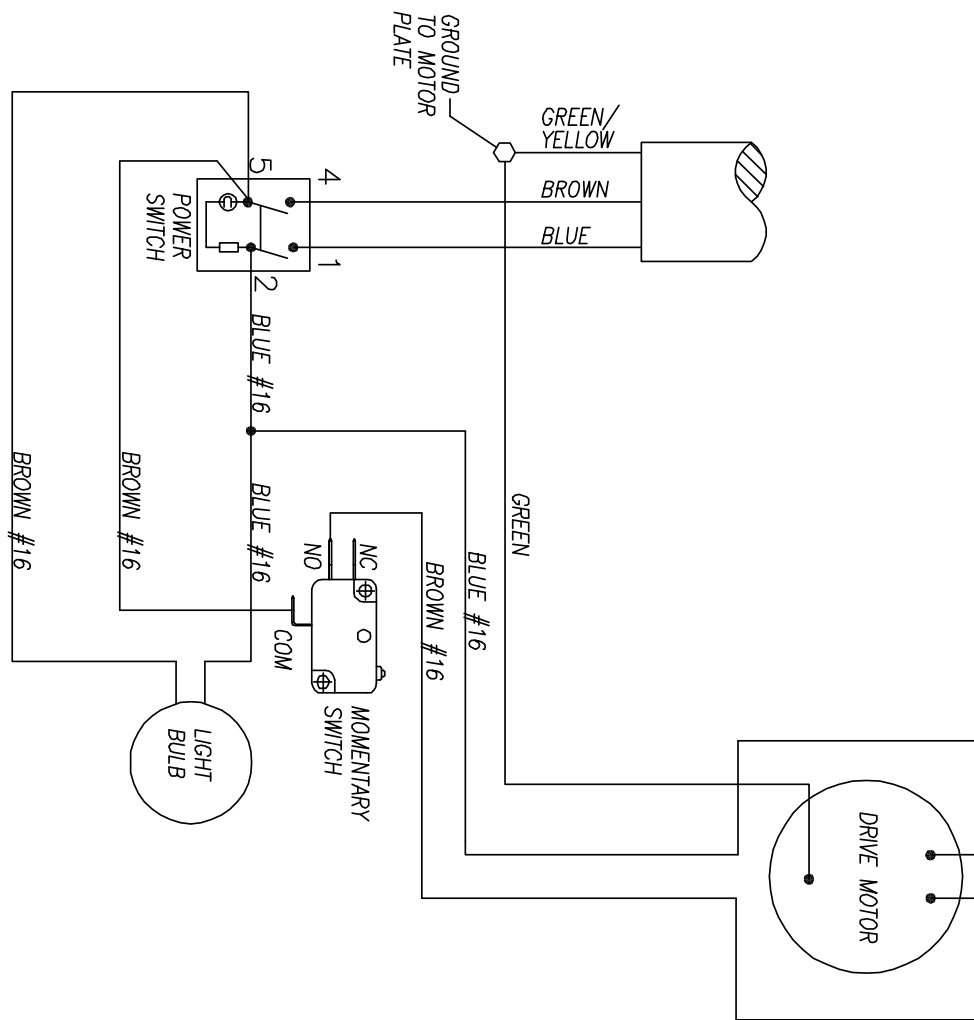

NOTE: ALL WIRING IS U.L. LISTED
18 GA., 105C.

NOTE:
1. CONFIRM MOTOR ROTATION, MOTOR MUST ROTATE COUNTER CLOCKWISE (CCW) WHEN VIEWED FROM THE SHAFT END OF THE MOTOR.
REFER TO MOTOR DATA PLATE FOR PROPER INTERNAL MOTOR WIRING CONNECTIONS.

ELECTRICAL SCHEMATIC – MODEL #1002-01-100

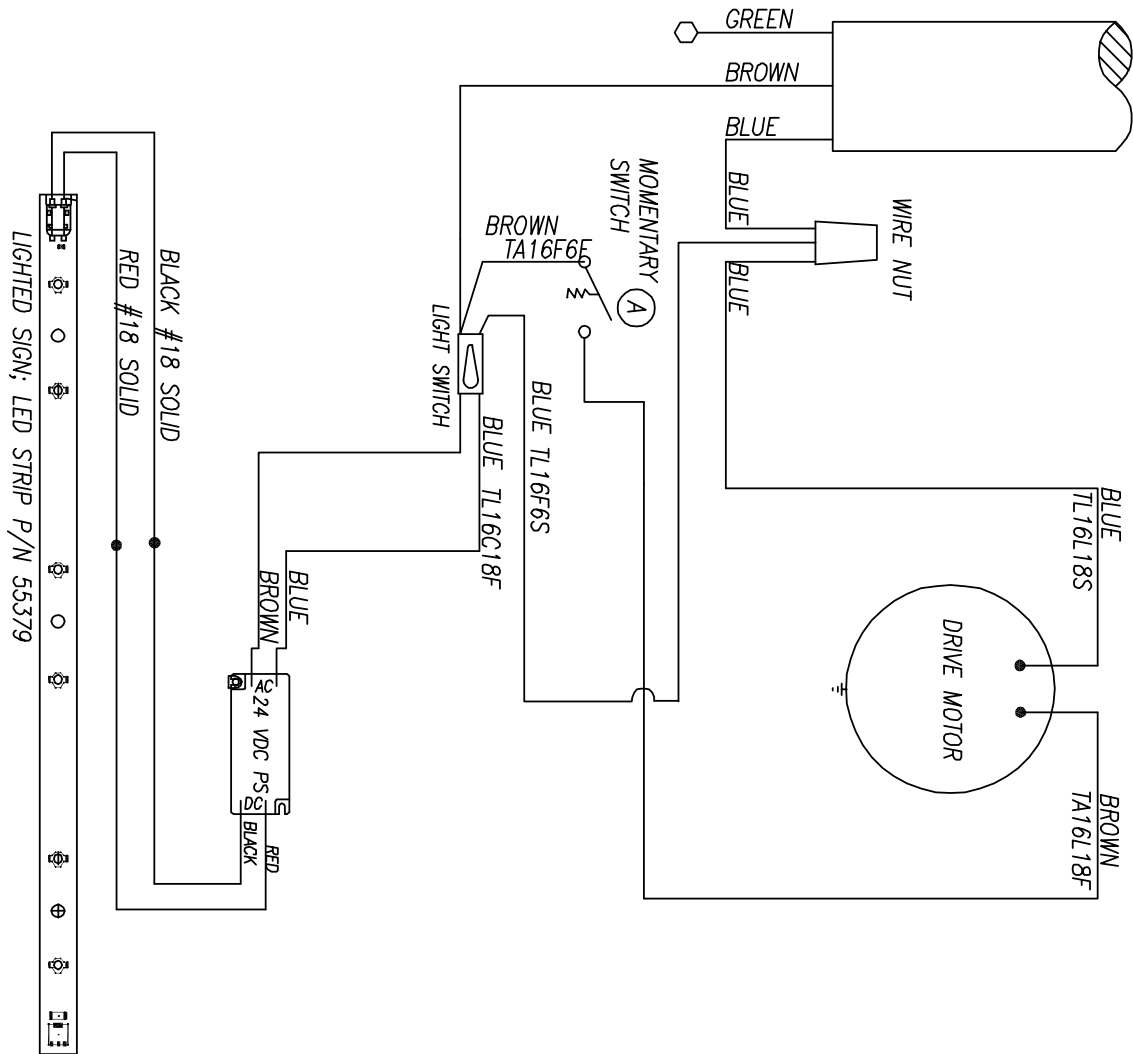

ELECTRICAL SCHEMATIC – MODEL #1009S

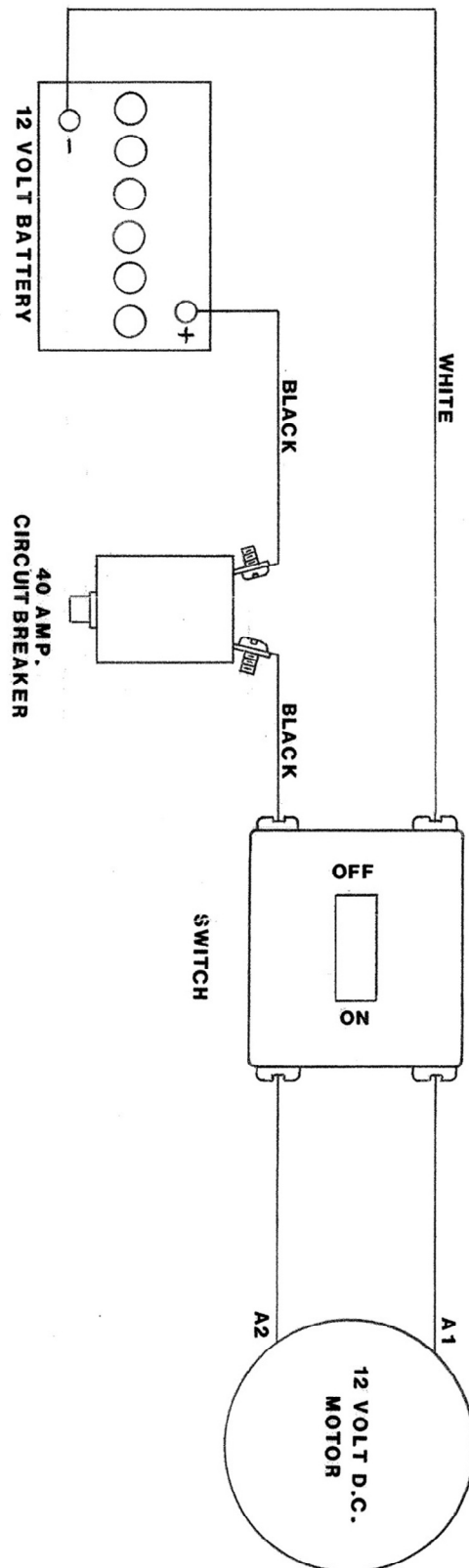

WARRANTY

Gold Medal Products Co. warrants to the original purchaser each item of its manufacture to be free of defects in workmanship and material under normal use and service. Gold Medal Products Co.'s obligation under this warranty is limited solely to repairing or replacing parts, f.o.b. Cincinnati, Ohio, which in its judgment are defective in workmanship or material and which are returned, freight prepaid, to its Cincinnati, Ohio factory or other designated point. Except for "Perishable Parts" on specific machines, the above warranty applies for a period of two (2) years from the date of original sale to the original purchaser of equipment when recommended operating instructions and maintenance procedures have been followed. These are packed with the machine. Parts warranty is two (2) years, labor is six (6) months.

THIS WARRANTY IS IN LIEU OF ALL OTHER WARRANTIES EXPRESSED OR IMPLIED, AND OF ALL OTHER OBLIGATIONS OR LIABILITIES ON OUR PART, INCLUDING THE IMPLIED WARRANTY OF MERCHANTABILITY. THERE ARE NO WARRANTIES WHICH EXTEND BEYOND THE DESCRIPTION ON THE FACE HEREOF. In no event shall Gold Medal Products Co. be liable for special, incidental or consequential damages. No claim under this warranty will be honored if the equipment covered has been misused, neglected, damaged in transit, or has been tampered with or changed in any way. No claim under this warranty shall be honored in the event that components in the unit at the time of the claim were not supplied or approved by Gold Medal Products Co. This warranty is effective only when electrical items have been properly attached to city utility lines only at proper voltages. This warranty is not transferable without the written consent of Gold Medal Products Co.

The term "Original Purchaser" as used in this warranty shall be deemed to mean that person, firm, association, or corporation who was billed by the GOLD MEDAL PRODUCTS CO., or their authorized distributor for the equipment.

THIS WARRANTY HAS NO EFFECT AND IS VOID UNLESS THE ORIGINAL PURCHASER FIRST CALLS GOLD MEDAL PRODUCTS CO. AT 1-800-543-0862 TO DISCUSS WITH OUR SERVICE REPRESENTATIVE THE EQUIPMENT PROBLEM, AND, IF NECESSARY, FOR INSTRUCTIONS CONCERNING THE REPAIR OR REPLACEMENT OF PARTS.

NOTE: This equipment is manufactured and sold for commercial use only.



GOLD MEDAL[®] PRODUCTS CO.

10700 Medallion Drive, Cincinnati, Ohio 45241-4807 USA

gmpopcorn.com

Phone: (800) 543-0862 Fax: (800) 542-1496
(513) 769-7676 (513) 769-8500

© 2015 – The text, descriptions, graphics, layout, and other material in this publication are the exclusive property of Gold Medal Products Co. and shall not be used, copied, reproduced, or published in any fashion, including website display, without its express written consent.