



# Instruction Manual

## Hawaii's Finest

Model No. 1027





**GOLD MEDAL® PRODUCTS CO.**

10700 Medallion Drive, Cincinnati, Ohio 45241-4807 USA





# SAFETY PRECAUTIONS

	<b>⚠ DANGER</b>
	<p>Machine must be properly grounded to prevent electrical shock to personnel. Failure to do so could result in serious injury, or death. DO NOT immerse any part of this equipment in water. DO NOT use excessive water when cleaning. Keep cord and plug off the ground and away from moisture. Always unplug the equipment before cleaning or servicing. Make sure all machine switches are in the OFF position before plugging the equipment into the receptacle.</p> <p>008_051514</p>

	<b>⚠ DANGER</b>
	<p>Improper installation, adjustment, alteration, service, or maintenance can cause property damage, injury, or death. Any alterations to this equipment will void the warranty and may cause a dangerous condition. NEVER make alterations to this equipment. Read the Installation, Operating, and Maintenance Instructions thoroughly before installing, servicing, or operating this equipment.</p> <p>014_051514</p>

	<b>⚠ WARNING</b>
	<p>This machinery contains sharp blades. Keep hands and body parts clear at all times.</p> <p>037_103114</p>

	<b>⚠ WARNING</b>
	<p>NEVER put your fingers into the shaver body (the goose-neck, ice chute, or hopper). Serious injury may occur.</p> <p>017_103114</p>

	<b>⚠ WARNING</b>
	<p>ALWAYS wear safety glasses when servicing this equipment.</p> <p>010_010914</p>

	<b>⚠ WARNING</b>
	<p>No user serviceable parts inside. Refer servicing to qualified service personnel.</p> <p>011_051514</p>



# SAFETY PRECAUTIONS (continued)

	<b>⚠ WARNING</b>
	<p>Read and understand operator's manual and all other safety instructions before using this equipment. To order copies of the operator's manual go to <a href="http://gmpopcorn.com">gmpopcorn.com</a> or write to Gold Medal Products Co., 10700 Medallion Drive, Cincinnati, OH 45241 USA 1-(800)-543-0862</p> <p style="text-align: right;">022_010914</p>

	<b>⚠ WARNING</b>
	<p>DO NOT allow direct contact of this equipment by the public when used in food service locations. Only personnel trained and experienced in the equipment operation may operate this equipment. Carefully read all instructions before operation.</p> <p style="text-align: right;">012_010914</p>

	<b>⚠ WARNING</b>
	<p>This machine is NOT to be operated by minors.</p> <p style="text-align: right;">007_010914</p>

**Note:** Improvements are always being made to Gold Medal's equipment. This information may not be the latest available for your purposes. It is critical that you call Gold Medal's Technical Service Department at 1-800-543-0862 for any questions about your machine operations, replacement parts, or any service questions. (Gold Medal Products Co. does not assume any liability for injury due to careless handling and/or reckless operation of this equipment.)

## General Operating Safety when using a Foot Switch

	<b>⚠ WARNING</b>
	Always use a grounded plug or cable. DO NOT cut off the ground prong and be sure to ground the foot switch with the ground screw provided.

	<b>⚠ CAUTION</b>
	Failure to use foot switch safely could result in personal injury. Foot switch should only be used where adequate guards or other safety devices are in place for those applications where the use of a foot switch could cause personal injury.

- Follow the appropriate wiring and safety requirements as set forth in the American National Standards Institute (ANSI) and National Electrical Code (NEC) or other appropriate standards.
- Use proper electrical circuits and circuit protection when wiring foot switch.
- Disconnect power before servicing.
- Do not allow cord to rest on floor or in areas where it can be a tripping hazard or can be abused by heavy traffic.
- Do not leave foot switch accessible to inadvertent operation when left unattended or when not being used.
- Do not bypass any machine or equipment safety features with this foot switch.
- Replace damaged cord immediately.
- It is the responsibility of the user to determine the suitability of a foot control for the intended use.
- It is the responsibility of the user to comply with federal, state and local safety and health regulations.



---

# INSTALLATION INSTRUCTIONS

## Inspection of Shipment

After unpacking, check thoroughly for any damage which may have occurred in transit. Claims should be filed immediately with the transportation company. The warranty does not cover damage that occurs in transit, or damage caused by abuse, or consequential damage due to the operation of this machine, since it is beyond our control (reference warranty in back of manual).

## Manual

Read and understand the operator's manual and all other safety instructions before using this equipment. To order copies of the operator's manual go to [gmpopcorn.com](http://gmpopcorn.com) or write to Gold Medal Products Co., 10700 Medallion Drive, Cincinnati, OH 45241 USA 1-(800)-543-0862.

## Items Included with this Unit

Drain Hose

Optional Accessory: Foot Switch (sold separately, Item No. 1008)

## Setup



This unit has been tested at the factory.

1. Remove all packaging and tape prior to operation.
2. Place unit on a sturdy, level base which can withstand accidental dripping of water and ice.
3. Connect the drain hose to funnel excess water to floor drain or basin tub. Drained water is not intended for human consumption.
4. After setup, the unit should be cleaned prior to use (see Care and Cleaning section of this manual).

## Electrical Requirements

The following power supply must be provided:

**1027:** 120 V~, 840 W, 60 Hz

	 <b>DANGER</b>
	<p>Machine must be properly grounded to prevent electrical shock to personnel. Failure to do so could result in serious injury, or death.  <b>DO NOT</b> immerse any part of this equipment in water.  <b>DO NOT</b> use excessive water when cleaning.            Keep cord and plug off the ground and away from moisture.            Always unplug the equipment before cleaning or servicing.            Make sure all machine switches are in the OFF position before plugging the equipment into the receptacle.</p> <p style="text-align: right;">008_051514</p>

A certified electrician must furnish sufficient power for proper machine operation and install any supplied receptacle. We recommend this equipment be on a dedicated and protected circuit. Failure to wire properly will void the warranty and may result in damage to the machine. It is Gold Medal Products Co.'s recommendation that this machine be plugged directly into a wall outlet. The use of extension cords is not recommended due to safety concerns, and may cause sacrificed and/or reduced performance. Make sure cord is located to prevent a trip hazard or unit upset.

## Before You Plug In Machine

1. Make sure all machine switches are in the OFF position before plugging the equipment into the receptacle.
2. Make sure the wall outlet can accept the grounded plugs (where applicable) on the power supply cord.
3. The wall outlet must have the proper polarity. If in doubt, have a competent electrician inspect the outlet and correct if necessary.
4. **DO NOT** use a grounded to un-grounded receptacle adapter (where applicable).
5. Install the unit in a level position.

	 <b>CAUTION</b>
	<p>If the supply cord is damaged, it must be replaced by a special cord or assembly available from Gold Medal Products Co. or its service agent.</p> <p style="text-align: right;">038_062714</p>

# OPERATING INSTRUCTIONS

## Controls and Their Functions

### MAIN SWITCH

Turns shaver motor "ON" or "OFF".

### RESET SWITCH

Motor overload switch.

### BLADE ADJUSTMENT KNOB

Adjusts the blade height to change the ice texture.

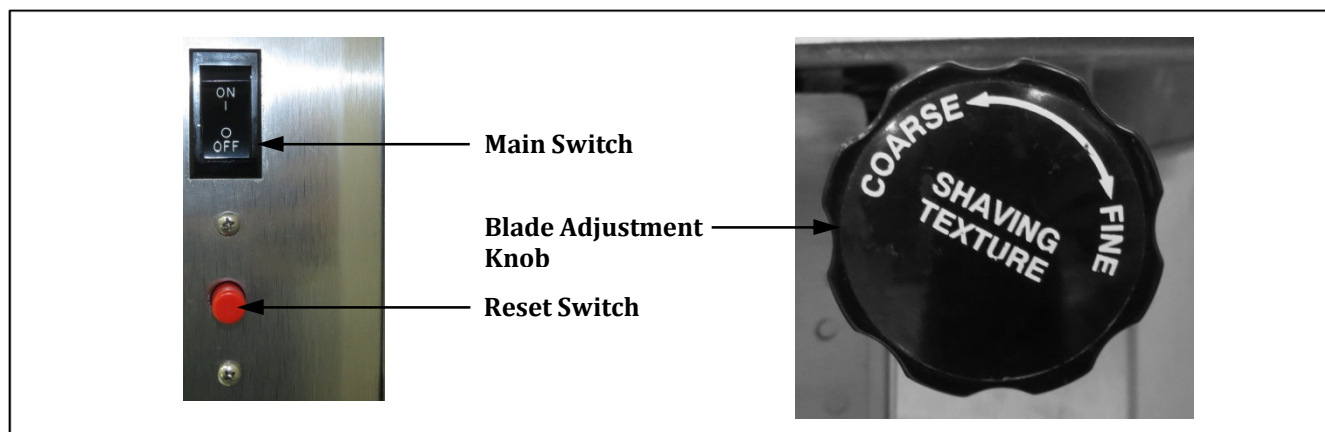

## Ice Requirements

The Hawaii's Finest can take ice cubes or block ice, if you break the block into pieces approximately 2 to 3 inches in size.

**NOTE:** The ice will not enter the shaving chute if the pieces are too large.

## Operation of Hawaii's Finest

1. Allow ice to soften at least 1 hour in an ice cooler before use. Using ice straight from the freezer affects the quality of the shaved ice as well as damage the shaver blade.
2. Lift cover lid and load ice cubes about  $\frac{1}{2}$  full then close the lid. Be sure ice is loaded evenly in each cavity. Place cup directly below the ice chute and turn power "ON". Failure to close the lid will cause machine not to operate!
3. Adjust the blade height with the adjustment knob to achieve the preferred ice texture.
4. To stop, turn power switch to the "OFF" position. Should the motor thermal protector trip, reset it by pushing the red button. It is recommended the cause of over load be found and eliminated before continuing. The machine may need to cool a bit before the reset button may take effect.

**NOTE:** Never allow any foreign or metallic objects around the shaver area of the Hawaii's Finest. Ice picks, scoops, and debris that may be in the ice often damage blades.

## Care and Cleaning

	<b>⚠ DANGER</b>
	Machine must be properly grounded to prevent electrical shock to personnel. <b>DO NOT immerse in water.</b> Always unplug the equipment before cleaning or servicing. <small>025_020314</small>

	<b>⚠ WARNING</b>
	This machinery contains sharp blades. Keep hands and body parts clear at all times. <small>037_103114</small>

Good sanitation practice demands that all food preparation equipment be cleaned regularly (only use non-toxic, food grade cleaners). A clean looking, well-kept machine is one of the best ways of advertising your product.

Follow the directions below to clean and sanitize the unit after each day of use.

1. With the machine OFF, unplug the unit before attempting to clean.
2. Empty water from pans and clean using appropriate cleaners for the type of machine; review all manufacturer's instructions and warnings on cleaning product prior to use.

**DO NOT** use oven cleaners or abrasive materials as they will damage parts of the machine.

**DO NOT** use Ammonia cleaners, they will damage plastic panels.



# MAINTENANCE INSTRUCTIONS

	<b>⚠ DANGER</b>
	<p>Machine must be properly grounded to prevent electrical shock to personnel. Failure to do so could result in serious injury, or death. DO NOT immerse any part of this equipment in water. DO NOT use excessive water when cleaning. Keep cord and plug off the ground and away from moisture. Always unplug the equipment before cleaning or servicing. Make sure all machine switches are in the OFF position before plugging the equipment into the receptacle.</p> <p>008_051514</p>

	<b>⚠ DANGER</b>
	<p>Improper installation, adjustment, alteration, service, or maintenance can cause property damage, injury, or death. Any alterations to this equipment will void the warranty and may cause a dangerous condition. NEVER make alterations to this equipment. Read the Installation, Operating, and Maintenance Instructions thoroughly before installing, servicing, or operating this equipment.</p> <p>014_051514</p>

	<b>⚠ WARNING</b>
	<p>No user serviceable parts inside. Refer servicing to qualified service personnel.</p> <p>011_051514</p>

	<b>⚠ CAUTION</b>
	<p>THE FOLLOWING SECTIONS OF THIS MANUAL ARE INTENDED ONLY FOR QUALIFIED SERVICE PERSONNEL WHO ARE FAMILIAR WITH ELECTRICAL EQUIPMENT. THESE ARE NOT INTENDED FOR THE OPERATOR.</p> <p>027_010914</p>

# Blade Replacement

	<p><b>WARNING</b></p> <p>This machinery contains sharp blades. Keep hands and body parts clear at all times.</p> <p style="text-align: right;">037_103114</p>
---	---

This section describes the steps to replace the shaver blade and to disassemble the impeller. ALWAYS turn the machine OFF and unplug unit from the power supply prior to disassembly or replacement.

## Steps for Blade Removal and Replacement

- Step 1:** Turn machine OFF, and unplug the unit from the power supply.
- Step 2:** Remove the (2) screws fastening the ice chute, and remove ice chute.
- Step 3:** Unscrew the blade adjustment knob, and remove shaft.
- Step 4:** Pull pivot pin out completely to free blade assembly and spring for removal.
- Step 5:** Unfasten the (2) blade retaining screws, then remove blade from assembly.
- Step 6:** Position new blade on assembly and fasten with the (2) blade retaining screws. (Blade may be sharpened for reuse.)
- Step 7:** Reassemble in reverse order (make sure spring properly sets between blade assembly and unit).

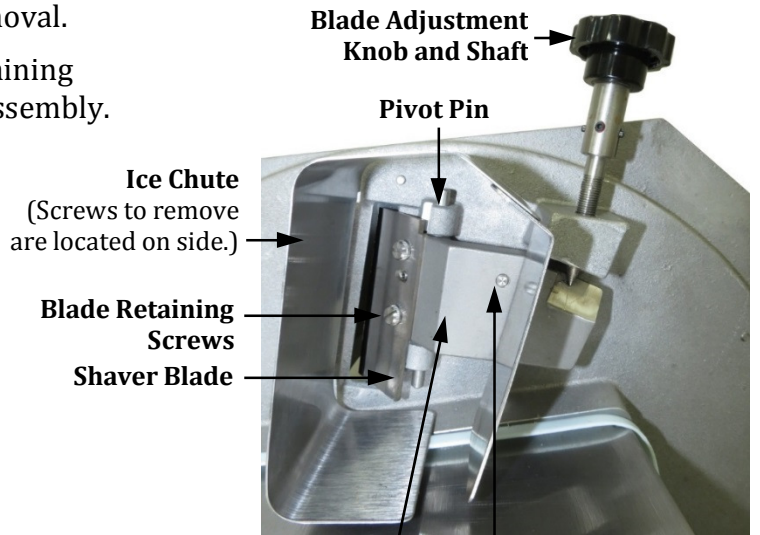

Blade Assembly      Spring (located between Blade Assembly and Unit)

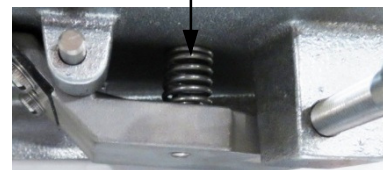



---

## To Disassemble the Impeller

1. Turn machine OFF, and unplug the unit from the power supply.
2. Remove lid by removing the wing nut and hinge pin.
3. Remove the four plastic button screws that hold the top hopper cover, then lift and roll over.
3. Disconnect wire harness at plug.
4. Remove three thumb screws and remove impeller cover.
5. Remove impeller knob, and lift impeller off.

**Note:** For removal of Impeller Knob a screwdriver slot is supplied on bottom end of motor.



---

## ORDERING SPARE PARTS

1. Identify the needed part by checking it against the photos, illustrations, and/or parts list.
2. When ordering, please include part number, part name, and quantity needed.
3. Please include your model number, serial number, and date of manufacture (located on the machine nameplate) with your order.
4. Address all parts orders to:

Parts Department  
Gold Medal Products Co.  
10700 Medallion Drive  
Cincinnati, Ohio 45241-4807

Or, place orders by phone or online:

Phone: (800) 543-0862  
(513) 769-7676

Fax: (800) 542-1496  
(513) 769-8500

E-mail: [info@gmpopcorn.com](mailto:info@gmpopcorn.com)

Web Page: [www.gmpopcorn.com](http://www.gmpopcorn.com)



## Cabinet Exterior Assembly

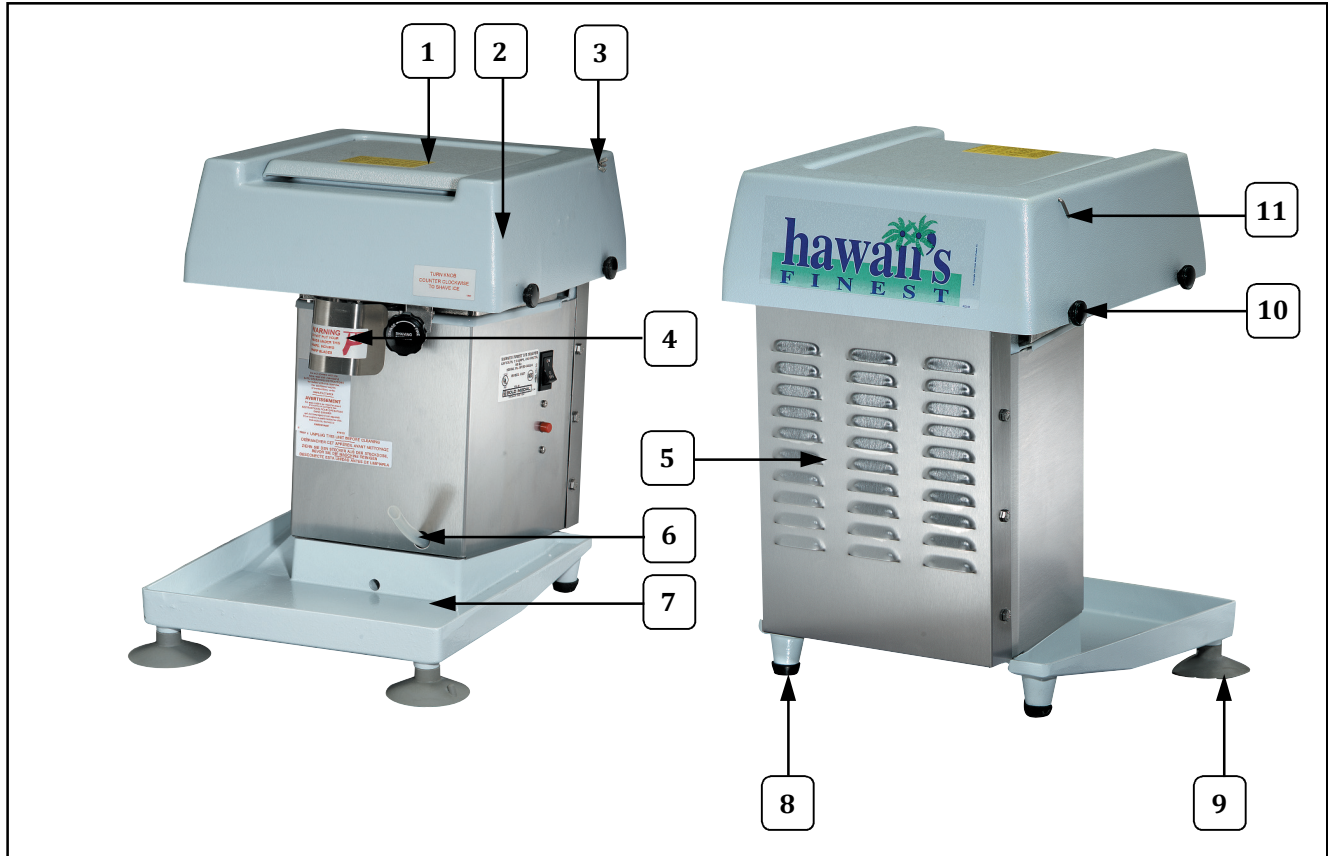

Item	Part Description	Qty.	Part No. 1027
1	TOP COVER DOOR	1	12119W
2	TOP COVER	1	12557W
3	WING NUT 6-32 STL ST	1	12152
4	ICE CHUTE WELD ASSEMBLY	1	12683
5	BACK COVER	1	12638
6	1/2 ID SILCON TUBING	1.3 ft.	12156
7	BASE	1	12088
8	RUBBER BUMPER	2	12487
9	SUCTION CUP, 1/4-20 STUD	2	12642
10	TOP COVER KNOB	4	12112
11	HINGE PIN DOOR	1	12145



## Cabinet Bottom Assembly

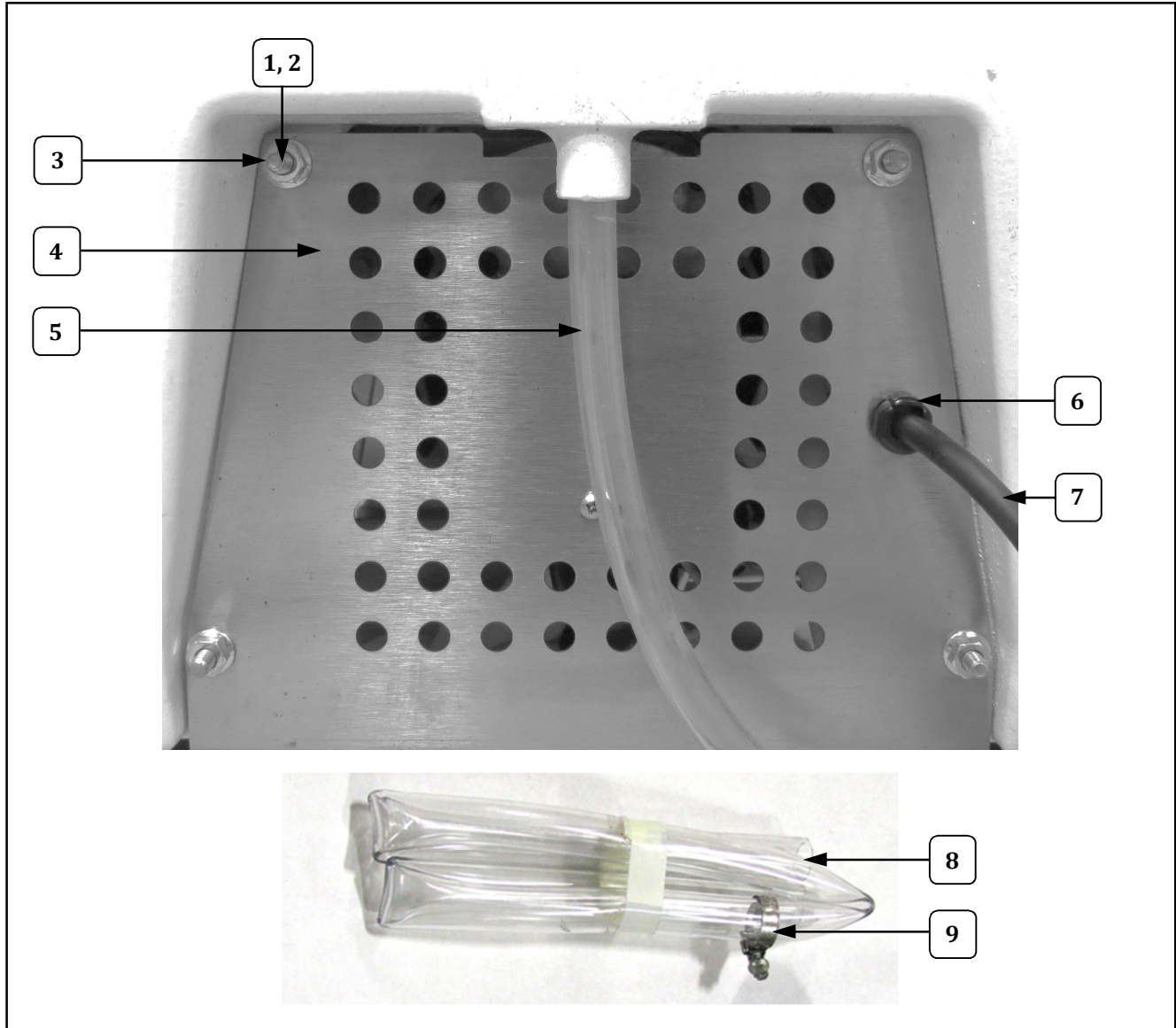

Item	Part Description	Qty.	Part No.
			1027
1	1/4-20 X 1 HX HD C S 18-8	4	<a href="#">12185</a>
2	5/16 FLAT WASHER, 18-8	4	<a href="#">12184</a>
3	1/4-20 SERRATED LOCK NUT	4	<a href="#">46311</a>
4	BOTTOM COVER STAINLESS	1	<a href="#">12294</a>
5	1/2 ID SILCON TUBING	1.3 ft.	<a href="#">12156</a>
6	STRAIN RELIEF #SR-6P3-4	1	<a href="#">76026</a>
7	LEAD-IN CORD 15 AMP PLUG	1	<a href="#">12154</a>
8	DRAIN HOSE 3/4 ID 7/8 OD	4 ft.	<a href="#">12159</a>
9	HOSE CLAMP WITH SCREW	1	<a href="#">41163</a>



# Hopper Assembly

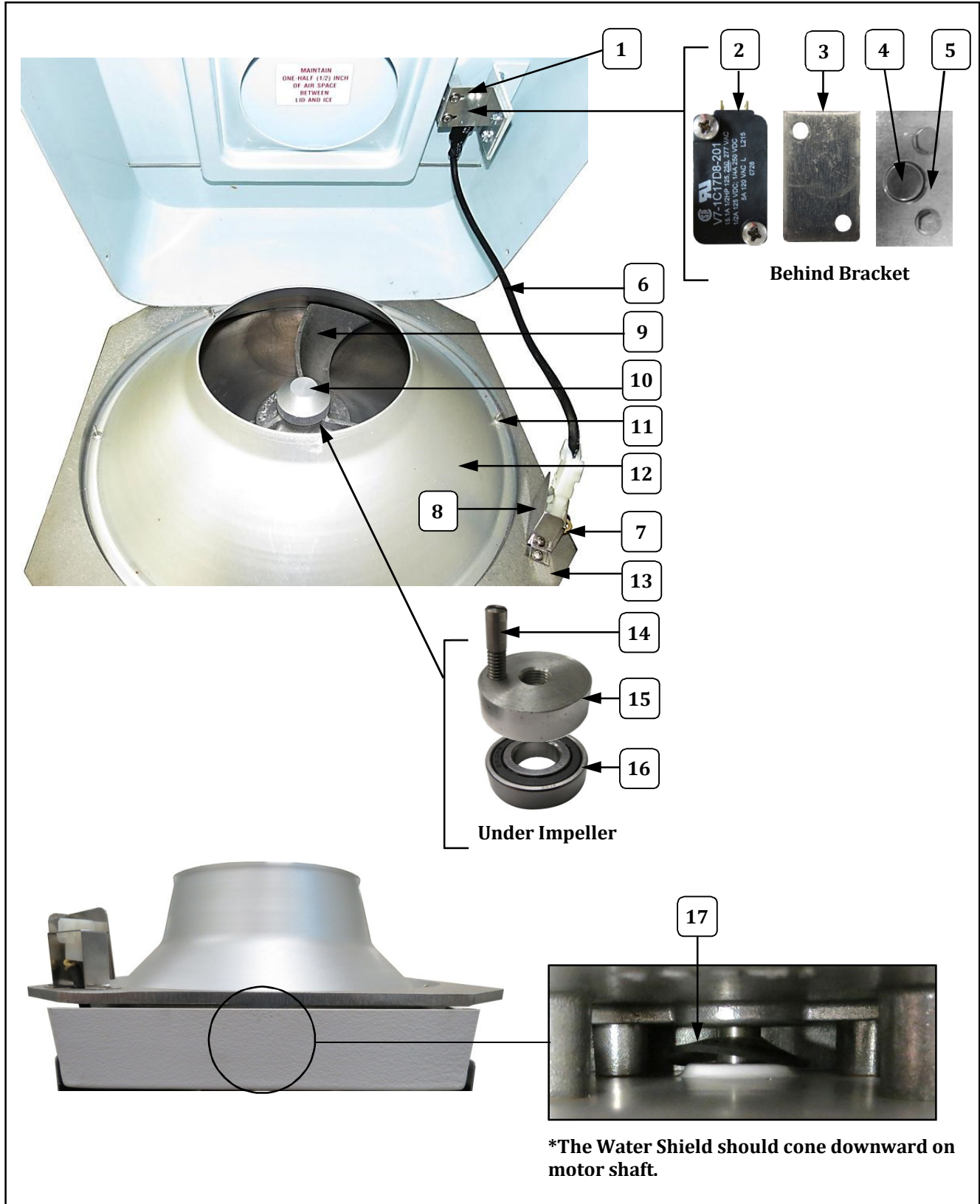



## Hopper Assembly – Parts List

Item	Part Description	Qty.	Part No.
			1027
1	SWITCH MOUNTING BRACKET	1	<a href="#">12136</a>
2	DOOR SAFTEY SWITCH	1	<a href="#">12116</a>
3	SPACER	1	<a href="#">12151</a>
4	1/2 OD X 1/2 T MAGNET	1	<a href="#">12078</a>
5	MOUNTING BLOCK MAGNET	1	<a href="#">12135</a>
6	DOOR SAFTEY SWITCH HARNESS	1	<a href="#">12131</a>
7	WIRING HARNESS BRACKET	1	<a href="#">12146</a>
8	WATER SHIELD HARNESS	1	<a href="#">12160</a>
9	IMPELLER	1	<a href="#">12090</a>
10	IMPELLER NUT	1	<a href="#">12106</a>
11	THUMB SCREW 10-32 X 3/8	6	<a href="#">12123</a>
12	SPINNING HOPPER (Impeller Cover)	1	<a href="#">12109</a>
13	UPPER BASIN	1	<a href="#">12556</a>
14	PUSHER STUD	1	<a href="#">12104</a>
15	PUSHER IMPELLER	1	<a href="#">12098</a>
16	BALL BEARING F. 5/8" SHFT	1	<a href="#">12091</a>
17	SHIELD - WATER	1	<a href="#">12097</a>



# Shaver Assembly

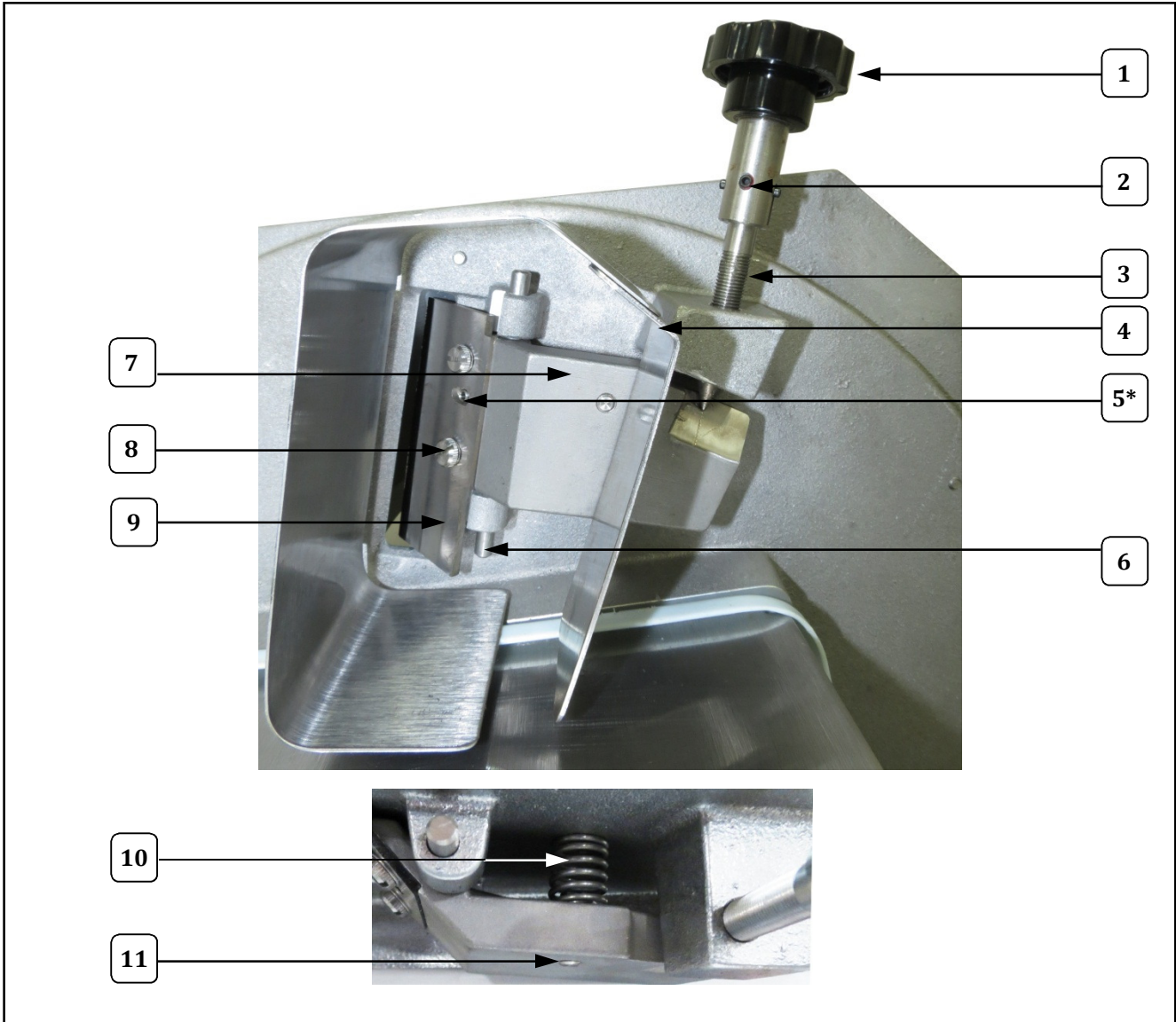

Item	Part Description	Qty.	Part No.
			1027
1	BLADE ADJUSTMENT KNOB	1	<a href="#">12111</a>
2	SET SCREW 8-32 X 1/8 S.S.	1	<a href="#">12165</a>
3	BLADE ADJUSTMENT SCREW ASSEMBLY	1	<a href="#">12125</a>
4	ICE CHUTE WELD ASSY	1	<a href="#">12683</a>
5*	10-32 x 1/2 HOLLOW SET*	1	<a href="#">12129</a>
6	BLADE HOLDER PIN	1	<a href="#">12110</a>
7	BLADE HOLDER	1	<a href="#">12195</a>
8	THUMB SCREW 10-32 X 3/8 (Blade retaining screw)	2	<a href="#">12158</a>
9	SHAVER BLADE	1	<a href="#">12094</a>
10	COMPRESSION SPRING	1	<a href="#">12117</a>
11	STUD-SPRING RETAINER	1	<a href="#">12143</a>

**\*NOTE:** Factory pre-set, **DO NOT** tamper with.



## Cabinet Internal Assembly

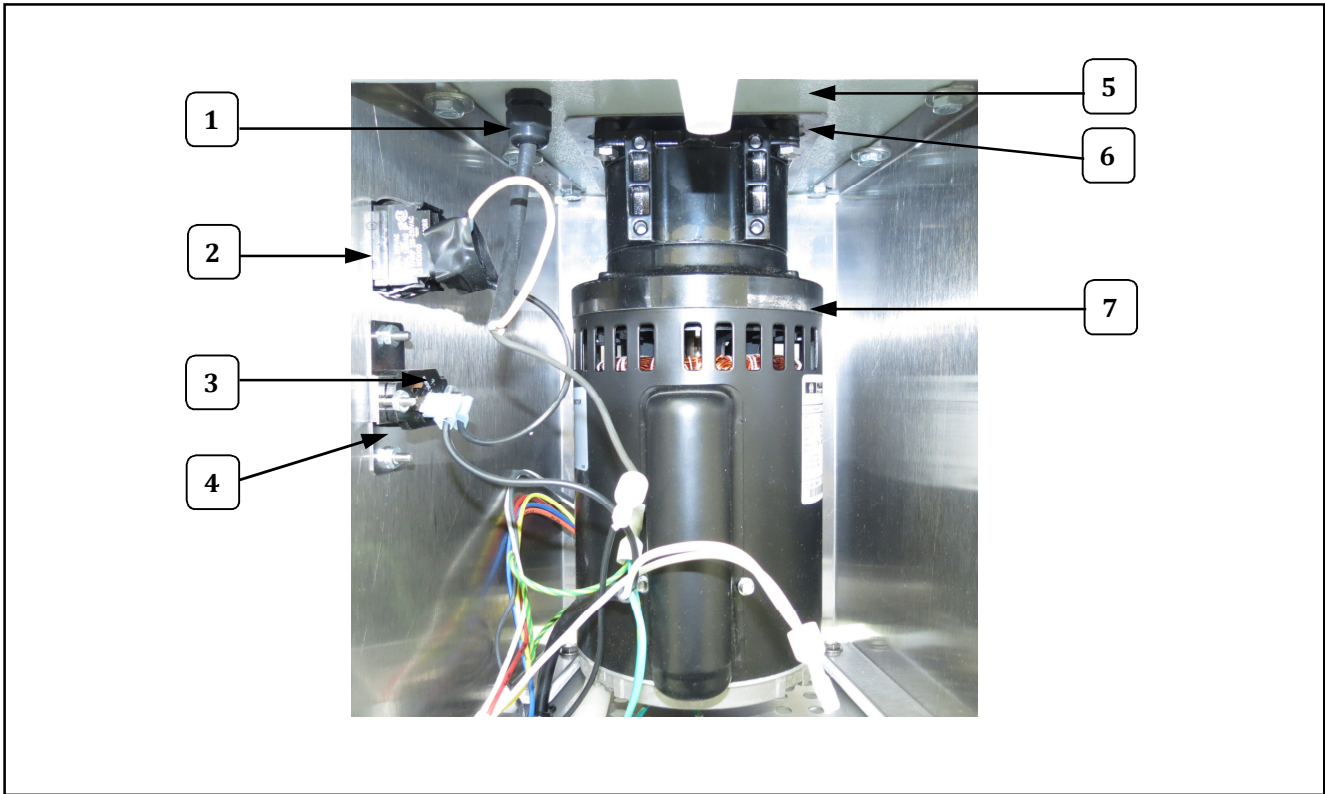

Item	Part Description	Qty.	Part No.
			1027
1	STRAIN RELIEF-WATER TIGHT	1	<a href="#">12149</a>
2	SPST ROCKER SWITCH	1	<a href="#">12115</a>
3	RESET SWITCH	1	<a href="#">12182</a>
4	MOUNT BRACKET-SWITCH	1	<a href="#">12181</a>
5	DRAIN TRAY UPPER BASIN	1	<a href="#">12553</a>
6	MOTOR SUPPORT PLATE	1	<a href="#">12514</a>
7	DRIVE MOTOR 1/3 HP	1	<a href="#">12194</a>



# WIRING DIAGRAM

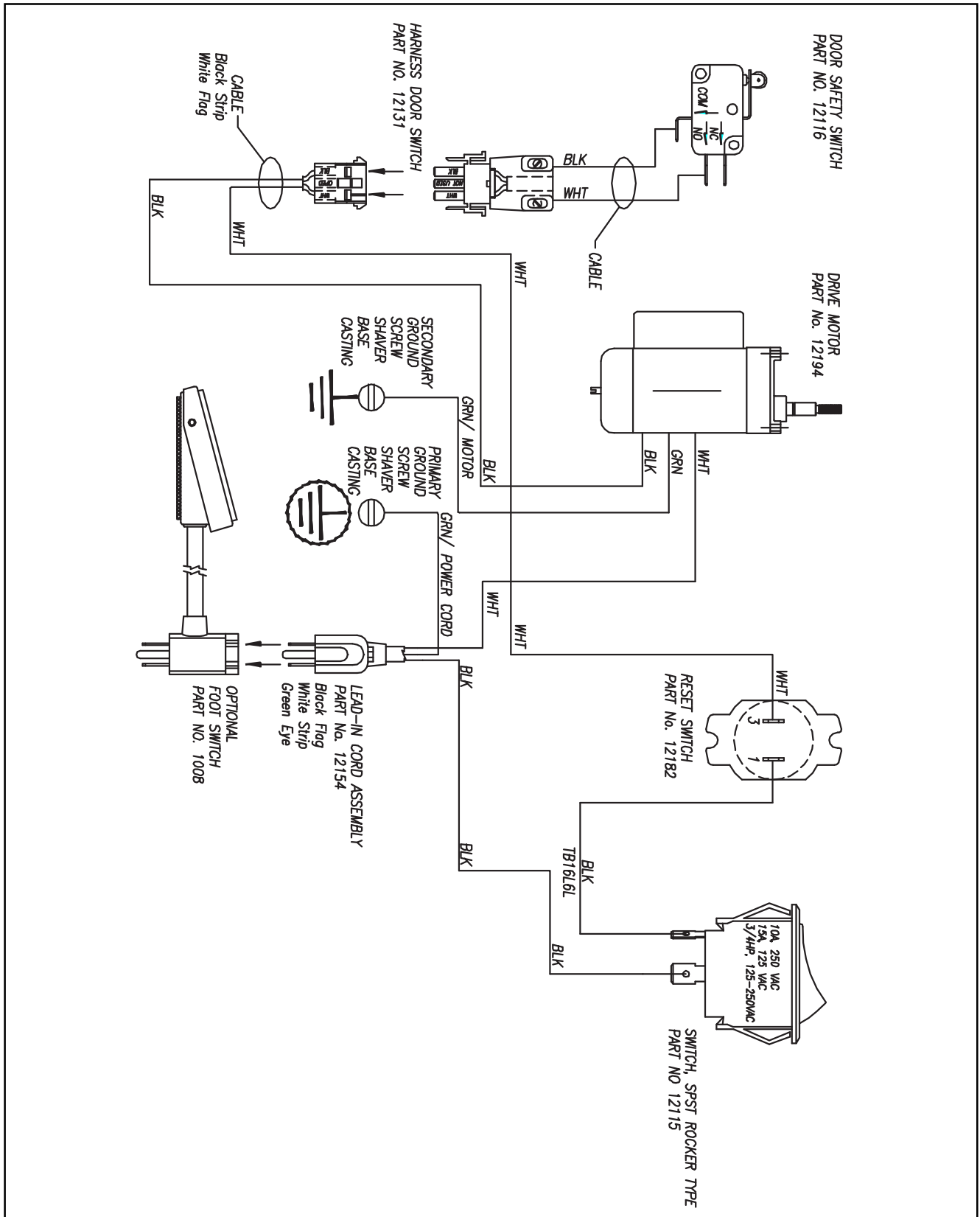



# WARRANTY

Gold Medal Products Co. warrants to the original purchaser each item of its manufacture to be free of defects in workmanship and material under normal use and service. Gold Medal Products Co.'s obligation under this warranty is limited solely to repairing or replacing parts, f.o.b. Cincinnati, Ohio, which in its judgment are defective in workmanship or material and which are returned, freight prepaid, to its Cincinnati, Ohio factory or other designated point. Except for "Perishable Parts" on specific machines, the above warranty applies for a period of two (2) years from the date of original sale to the original purchaser of equipment when recommended operating instructions and maintenance procedures have been followed. These are packed with the machine. Parts warranty is two (2) years, labor is six (6) months.

THIS WARRANTY IS IN LIEU OF ALL OTHER WARRANTIES EXPRESSED OR IMPLIED, AND OF ALL OTHER OBLIGATIONS OR LIABILITIES ON OUR PART, INCLUDING THE IMPLIED WARRANTY OF MERCHANTABILITY. THERE ARE NO WARRANTIES WHICH EXTEND BEYOND THE DESCRIPTION ON THE FACE HEREOF. In no event shall Gold Medal Products Co. be liable for special, incidental or consequential damages. No claim under this warranty will be honored if the equipment covered has been misused, neglected, damaged in transit, or has been tampered with or changed in any way. No claim under this warranty shall be honored in the event that components in the unit at the time of the claim were not supplied or approved by Gold Medal Products Co. This warranty is effective only when electrical items have been properly attached to city utility lines only at proper voltages. This warranty is not transferable without the written consent of Gold Medal Products Co.

The term "Original Purchaser" as used in this warranty shall be deemed to mean that person, firm, association, or corporation who was billed by the GOLD MEDAL PRODUCTS CO., or their authorized distributor for the equipment.

THIS WARRANTY HAS NO EFFECT AND IS VOID UNLESS THE ORIGINAL PURCHASER FIRST CALLS GOLD MEDAL PRODUCTS CO. AT 1-800-543-0862 TO DISCUSS WITH OUR SERVICE REPRESENTATIVE THE EQUIPMENT PROBLEM, AND, IF NECESSARY, FOR INSTRUCTIONS CONCERNING THE REPAIR OR REPLACEMENT OF PARTS.

*NOTE: This equipment is manufactured and sold for commercial use only.*



**GOLD MEDAL<sup>®</sup> PRODUCTS CO.**

10700 Medallion Drive, Cincinnati, Ohio 45241-4807 USA

[gmpopcorn.com](http://gmpopcorn.com)

Phone: (800) 543-0862      Fax: (800) 542-1496  
(513) 769-7676              (513) 769-8500