



Instruction Manual

Shav-A-Doo

Model Series: 1203



GOLD MEDAL[®] PRODUCTS CO.

10700 Medallion Drive, Cincinnati, Ohio 45241-4807 USA



Table of Contents

SAFETY PRECAUTIONS 3

INSTALLATION INSTRUCTIONS 5

 Inspection of Shipment 5

 Manual 5

 Model Description 5

 Items Included with this Unit 5

 Setup 5

 Electrical Requirements 6

 Before You Plug In Machine 6

OPERATING INSTRUCTIONS 7

 Controls and Their Functions 7

 Ice Requirements 7

 Operating Instructions 7

Care and Cleaning 8

—THE FOLLOWING SECTIONS ARE FOR QUALIFIED SERVICE PERSONNEL ONLY— 9

MAINTENANCE INSTRUCTIONS 9

Installing New Shaver Blades 10

 Blade Replacement 10

 Set Blade Height 11

ORDERING SPARE PARTS 12

 Replacing Broken Glass 12

 Cabinet View 13



 Shaver Head and Accessories 14



Wiring Diagram 15



WARRANTY 17







SAFETY PRECAUTIONS



	 DANGER
	<p>Machine must be properly grounded to prevent electrical shock to personnel. Failure to do so could result in serious injury, or death. Make sure all machine switches are in the OFF position before plugging the equipment into the receptacle. Keep cord and plug off the ground and away from moisture. Always unplug the equipment before cleaning or servicing. DO NOT immerse any part of this equipment in water. DO NOT use a water jet or excessive water when cleaning.</p> <p style="text-align: right; font-size: small;">008_012221</p>

	 DANGER
	<p>Improper installation, adjustment, alteration, service, or maintenance can cause property damage, injury, or death. Any alterations to this equipment will void the warranty and may cause a dangerous condition. This appliance is not intended to be operated by means of an external timer or separate remote-control system. NEVER make alterations to this equipment. Read the Installation, Operating, and Maintenance Instructions thoroughly before installing, servicing, or operating this equipment.</p> <p style="text-align: right; font-size: small;">014_020416</p>

	 WARNING
	<p>This machinery contains sharp blades. Keep hands and body parts clear at all times.</p> <p style="text-align: right; font-size: small;">037_103114</p>



	 WARNING
	<p>NEVER put your fingers into the shaver body (the goose-neck, ice chute, or hopper). Serious injury may occur.</p> <p style="text-align: right; font-size: small;">017_103114</p>

	 WARNING
	<p>ALWAYS wear safety glasses when servicing this equipment.</p> <p style="text-align: right; font-size: small;">010_010914</p>

	 WARNING
	<p>No user serviceable parts inside. Refer servicing to qualified service personnel.</p> <p style="text-align: right; font-size: small;">011_051514</p>



	 WARNING
	<p>Read and understand operator's manual and all other safety instructions before using this equipment. To order copies of the operator's manual go to gmpopcorn.com or write to Gold Medal Products Co., 10700 Medallion Drive, Cincinnati, OH 45241 USA 1-(800)-543-0862</p> <p style="text-align: right; font-size: small;">022_060215</p>

	 WARNING
	<p>DO NOT allow direct contact of this equipment by the public when used in food service locations. Only personnel trained and experienced in the equipment operation may operate this equipment. Carefully read all instructions before operation.</p> <p style="text-align: right; font-size: small;">012_010914</p>

	 WARNING
	<p>This machine is NOT to be operated by minors.</p> <p style="text-align: right; font-size: small;">007_010914</p>

	 CAUTION
	<p>If the supply cord is damaged, it must be replaced by Gold Medal Products Co., its service agent or similarly qualified persons in order to avoid a hazard.</p> <p style="text-align: right; font-size: small;">039_080614</p>

This appliance is not intended for use by persons (including children) with reduced physical, sensory or mental capabilities, or lack of experience and knowledge, unless they have been given supervision or instruction concerning use of the appliance by a person responsible for their safety.

DO NOT install equipment in an area where a water jet is used.

Unit to be installed in locations where ambient temperatures are between a minimum of 5°C (41°F) and a maximum of 55°C (131°F).

Unit to be installed in locations where it can be overseen by trained personnel.

Install unit on a level surface.

Unit is for shaved ice.

Note: Improvements are always being made to Gold Medal's equipment. This information may not be the latest available for your purposes. It is critical that you call Gold Medal's Technical Service Department at 1-800-543-0862 for any questions about your machine operations, replacement parts, or any service questions. (Gold Medal Products Co. does not assume any liability for injury due to careless handling and/or reckless operation of this equipment.) General images may be used in manual for reference only.

INSTALLATION INSTRUCTIONS

Inspection of Shipment

After unpacking, check thoroughly for any damage which may have occurred in transit. Claims should be filed immediately with the transportation company. The warranty does not cover damage that occurs in transit, or damage caused by abuse, or consequential damage due to the operation of this machine, since it is beyond our control (reference warranty in back of manual).

Manual

Read and understand the operator's manual and all other safety instructions before using this equipment. To order copies of the operator's manual go to gmpopcorn.com or write to Gold Medal Products Co., 10700 Medallion Drive, Cincinnati, OH 45241 USA 1-(800)-543-0862.

Model Description

1203 Series Shav-A-Doo Ice Shaver.

Items Included with this Unit

- Plastic Snow Dipper (PN [1088](#))
- Ice Scoop (PN [39068](#))
- Drain Hose (PN [12159](#), order by the foot)
- Manual and Registration/Warranty Card

Setup

1. Remove all packing material and tape before starting operation.
2. Place unit on a sturdy, level base which can withstand accidental dripping of water and ice.
3. Set drain pan (with hose fitting) in unit—position fitting in unit opening, see image.
4. Push drain hose onto the barbed drain fitting. Drain hose funnels excess water to floor drain or basin tub. When in use, ensure the hose is positioned so water drains appropriately. Drained water is not intended for human consumption.
5. Unit should be cleaned prior to use (see Care and Cleaning section).

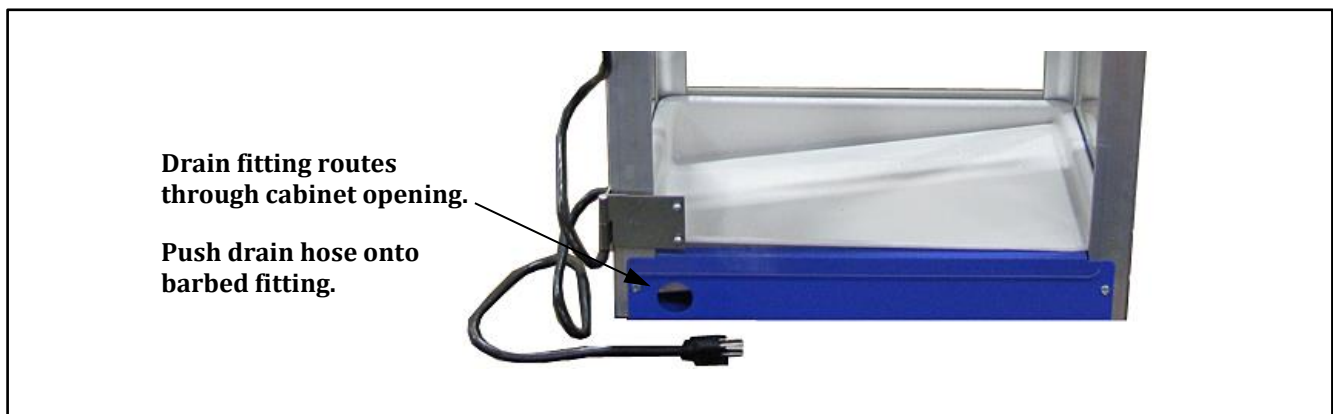



Electrical Requirements

The following power supply must be provided (reference unit Data Plate for Wattage requirement):

1203-00-000: 120 V~, 60 Hz

1203-01-000: 220-230 V~, 50/60 Hz

	 DANGER
	<p>Machine must be properly grounded to prevent electrical shock to personnel. Failure to do so could result in serious injury, or death. Make sure all machine switches are in the OFF position before plugging the equipment into the receptacle. Keep cord and plug off the ground and away from moisture. Always unplug the equipment before cleaning or servicing. DO NOT immerse any part of this equipment in water. DO NOT use a water jet or excessive water when cleaning.</p> <p style="text-align: right; font-size: small;">008_012221</p>

A certified electrician must furnish sufficient power for proper machine operation and install any supplied receptacle (reference unit Data Plate for model specific Volts AC, Hertz, and Wattage requirements). We recommend this equipment be on a dedicated and protected circuit. Failure to wire properly will void the warranty and may result in damage to the machine. It is Gold Medal Products Co.'s recommendation that this machine be plugged directly into a wall outlet. The use of extension cords is not recommended due to safety concerns, and may cause sacrificed and/or reduced performance. Make sure cord is located to prevent a trip hazard or unit upset.

Before You Plug In Machine

1. Make sure all machine switches are OFF before plugging equipment into receptacle.
2. Make sure wall outlet can accept the grounded plugs (where applicable) on the power supply cord.
3. The wall outlet must have the proper polarity. If in doubt, have a competent electrician inspect the outlet and correct if necessary.
4. **DO NOT** use a grounded to un-grounded receptacle adapter (where applicable).
5. Install unit in a level position.

	 CAUTION
	<p>If the supply cord is damaged, it must be replaced by Gold Medal Products Co., its service agent or similarly qualified persons in order to avoid a hazard.</p> <p style="text-align: right; font-size: small;">039_080614</p>



OPERATING INSTRUCTIONS

Controls and Their Functions

POWER SWITCH

Lighted Rocker Switch – supplies power to the momentary button switch.

MOMENTARY SWITCH

Momentary Switch must be engaged for unit to operate. Press switch to operate/energize the shaver motor; release the switch to de-energize the motor.

ICE HOPPER/PUSHER HANDLE

The hopper holds ice and funnels it to the shaver blades. Pusher Handle presses ice into the shaver blades.

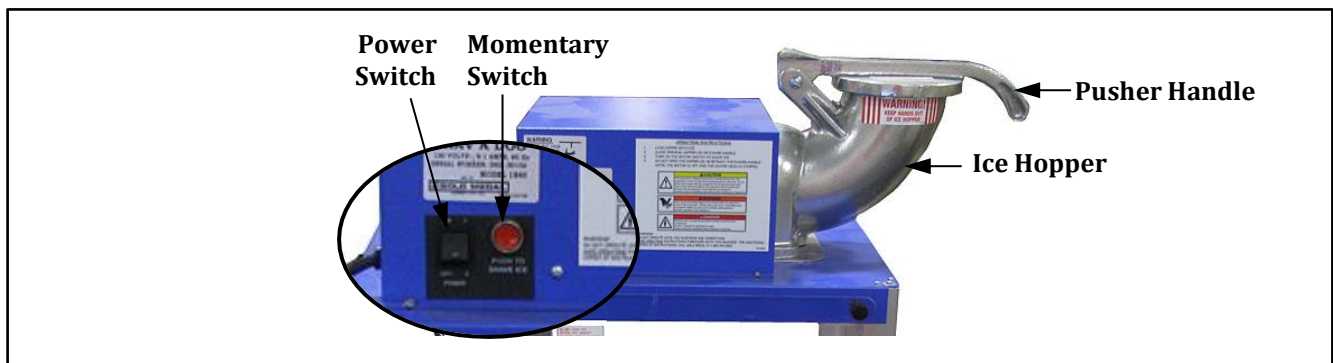

Ice Requirements

The shaver accepts ice cubes or block ice (if broken into pieces approximately 2 to 3 inches in size). **The ice will not enter the shaving chute if the pieces are too large.**

Note: Harder ice will result in finer snow; soft ice will result in coarser snow. Softened ice makes better snow and prolongs blade life.

Operating Instructions

1. Raise hopper handle (pusher) and load hopper with ice cubes (approx. 1" from top).
2. Close pusher handle.
3. Turn the power switch ON.
4. Apply gentle downward pressure on the hopper handle and press the momentary switch until all ice in hopper has been shaved, then release the button.

Practice helps you gauge when to stop and allow the ice to resettle against the shaver head. Applying too much pressure results in coarse snow; too little pressure can make snow mushy.



5. DO NOT lift the pusher until the motor is off and the shaver head has stopped.

Note: Never allow any foreign or metallic objects around the shaver area. Ice picks, scoops, and debris that may be in the ice often damage blades.



Care and Cleaning

	 DANGER
	Machine must be properly grounded to prevent electrical shock to personnel. DO NOT immerse in water. DO NOT clean appliance with a water jet or steam cleaner. Always unplug the equipment before cleaning or servicing. 025_051321

	 WARNING
	This machinery contains sharp blades. Keep hands and body parts clear at all times. 037_103114

Good sanitation practice demands that all food preparation equipment be cleaned regularly (only use non-toxic, food grade cleaners).

Follow the directions below to clean and sanitize the unit each day after use.

1. With the machine OFF, unplug the unit before attempting to clean.
2. Empty water from pans and clean using appropriate cleaners for the type of machine; review all manufacturer's instructions and warnings on cleaning product prior to use.



DO NOT use oven cleaners or abrasive materials as they will damage parts of the machine.



DO NOT use Ammonia cleaners, they will damage plastic panels.





—THE FOLLOWING SECTIONS ARE FOR QUALIFIED SERVICE PERSONNEL ONLY—

MAINTENANCE INSTRUCTIONS

	 DANGER
	<p>Machine must be properly grounded to prevent electrical shock to personnel. Failure to do so could result in serious injury, or death. Make sure all machine switches are in the OFF position before plugging the equipment into the receptacle. Keep cord and plug off the ground and away from moisture. Always unplug the equipment before cleaning or servicing. DO NOT immerse any part of this equipment in water. DO NOT use a water jet or excessive water when cleaning.</p> <p style="text-align: right; font-size: small;">008_012221</p>

	 DANGER
	<p>Improper installation, adjustment, alteration, service, or maintenance can cause property damage, injury, or death. Any alterations to this equipment will void the warranty and may cause a dangerous condition. This appliance is not intended to be operated by means of an external timer or separate remote-control system. NEVER make alterations to this equipment. Read the Installation, Operating, and Maintenance Instructions thoroughly before installing, servicing, or operating this equipment.</p> <p style="text-align: right; font-size: small;">014_020416</p>

	 WARNING
	<p>No user serviceable parts inside. Refer servicing to qualified service personnel.</p> <p style="text-align: right; font-size: small;">011_051514</p>

	 CAUTION
	<p>THE FOLLOWING SECTIONS OF THIS MANUAL ARE INTENDED ONLY FOR QUALIFIED SERVICE PERSONNEL WHO ARE FAMILIAR WITH ELECTRICAL EQUIPMENT. THESE ARE NOT INTENDED FOR THE OPERATOR.</p> <p style="text-align: right; font-size: small;">027_010914</p>



Installing New Shaver Blades

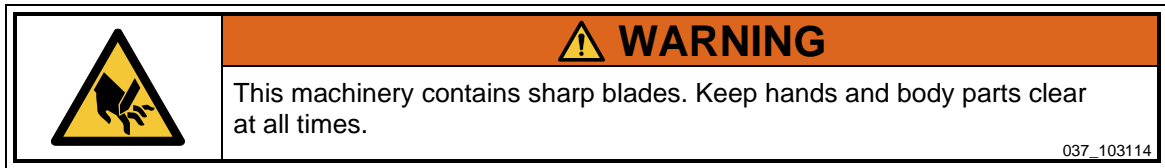

The section describes the procedure to replace the shaver blades. ALWAYS turn the machine OFF and unplug unit from the power supply prior to blade inspection or replacement. Use a flashlight to examine the blades in the shaver body. If the blades appear to be nicked or bent, then the blades should be replaced.

Blade Replacement

1. With the machine OFF, unplug the unit from the power supply.
2. Remove motor cover (keep all fasteners as they will be used to reinstall the cover).
3. Use a permanent marker and put a guide mark on the motor shaft where the shaver head stops; also place a small guide mark on the cabinet where the motor sets (reference shaver cut away view on next page).
4. To remove the shaver head from the motor shaft, loosen the motor mounting bolts. (If unit has a hopper support and guide, it must also be removed).
5. Pull motor back until the (2) Allen head set screws on the shaver head are visible. Loosen the (2) set screws (do not remove set screws).
6. Carefully guide the shaver head off of the motor shaft and through the hopper. If the shaver head is frozen to the shaft, pull the motor back trapping the shaver head against the inside of the hopper, until the shaver head disengages.
7. After removing the shaver head, check the motor shaft for burrs and corrosion (use a fine tooth file to remove any burrs or corrosion).
8. Remove blades from shaver head. Replace old blades with a new set (blades may be re-sharpened).
9. Position new blades on shaver head and insert blade mounting screws until finger tight.
10. Set the blade thickness to 1/32" (0.8 mm) using a height gauge (thickness of a dime), reference Set Blade Height illustration shown on next page. Make sure the blade height is even across the shaver head.
11. Tighten the blade mounting screws completely. Check the blade height again to ensure the blades did not move while tightening the screws.
12. Carefully guide the shaver head through the hopper and back onto the motor shaft; realign head with guide mark made on the shaft in Step 3 above. (The pusher handle may be used to help press the shaver head onto the shaft.)
13. The shaver head set screws must be on the flat side of the motor shaft. Once aligned, fasten set screws securely.



- Adjust the motor to realign with guide mark made on the cabinet in Step 3, then refasten motor mounting bolts (if unit has a hopper support and guide, it must also be reinstalled). Check the shaver head to make sure it is not rubbing against the back of the hopper and the blades are not touching the pusher handle or sides of hopper; adjust as needed.

NOTE: Replace any shims that were between the motor base and the mounting surface.

- Reinstall motor cover.

Cut Away View of Shaver Head on Motor Shaft

General shaver image shown for reference only (models may vary).

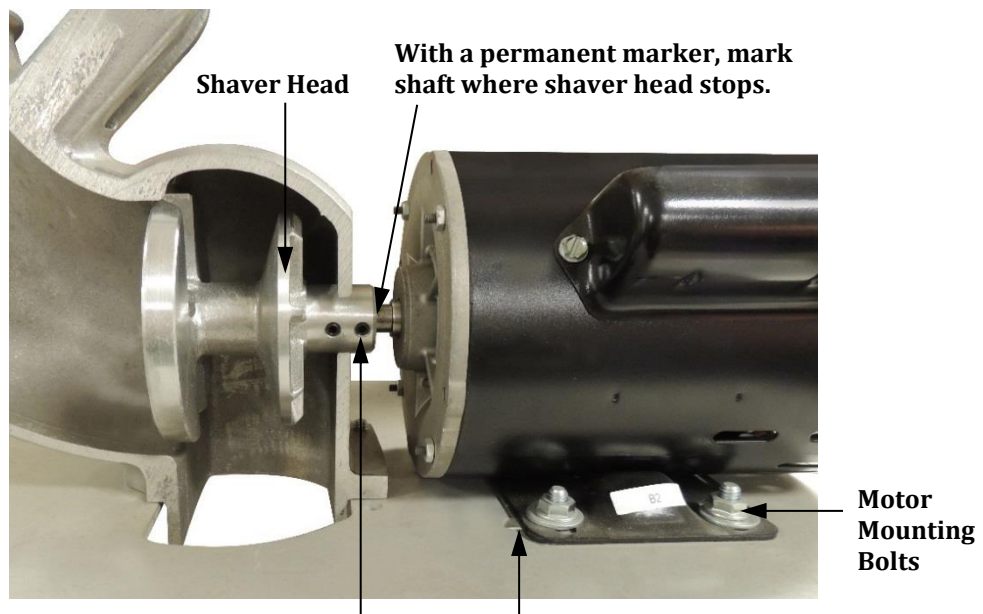

(2) Set Screws (fasten on flat side of motor shaft)

With a permanent marker, mark cabinet where motor sets.

Set Blade Height

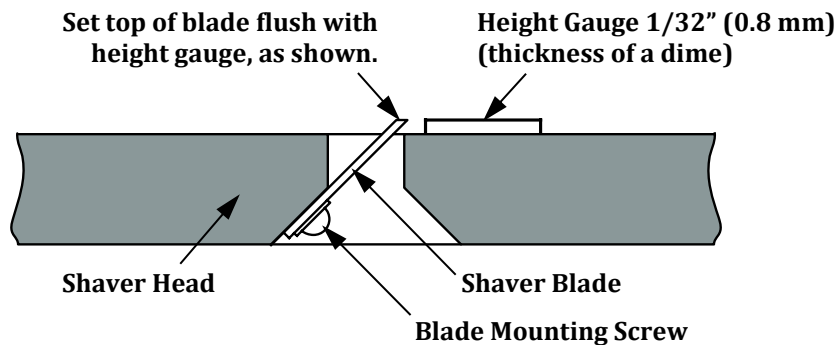



ORDERING SPARE PARTS

1. Identify the needed part by checking it against the photos, illustrations, and/or parts list. (General images may be used in manual for reference only.)
2. Use only approved replacement parts when servicing this unit.
3. When ordering, please include part number, part name, and quantity needed.
4. Please include your model number, serial number, and date of manufacture (located on the machine nameplate/data plate) with your order.
5. Address all parts orders to Parts Department, Gold Medal Products Co., 10700 Medallion Drive, Cincinnati, Ohio 45241-4807

or place orders by phone or online:

Phone: (800) 543-0862
(513) 769-7676

Fax: (800) 542-1496
(513) 769-8500

E-mail: info@gmpopcorn.com
Web Page: gmpopcorn.com

Replacing Broken Glass

Broken glass panels can be easily replaced. Gold Medal Products Co. does not ship glass. It can be obtained from a local glass shop, always purchase tempered glass.

GLASS DIMENSIONS (Height x Width x Thickness)

Front Glass: 13.354" x 15.6" x 1/8" (1 Piece)

Side Glass: 13.354" x 11.989" x 1/8" (2 Pieces)



Cabinet View

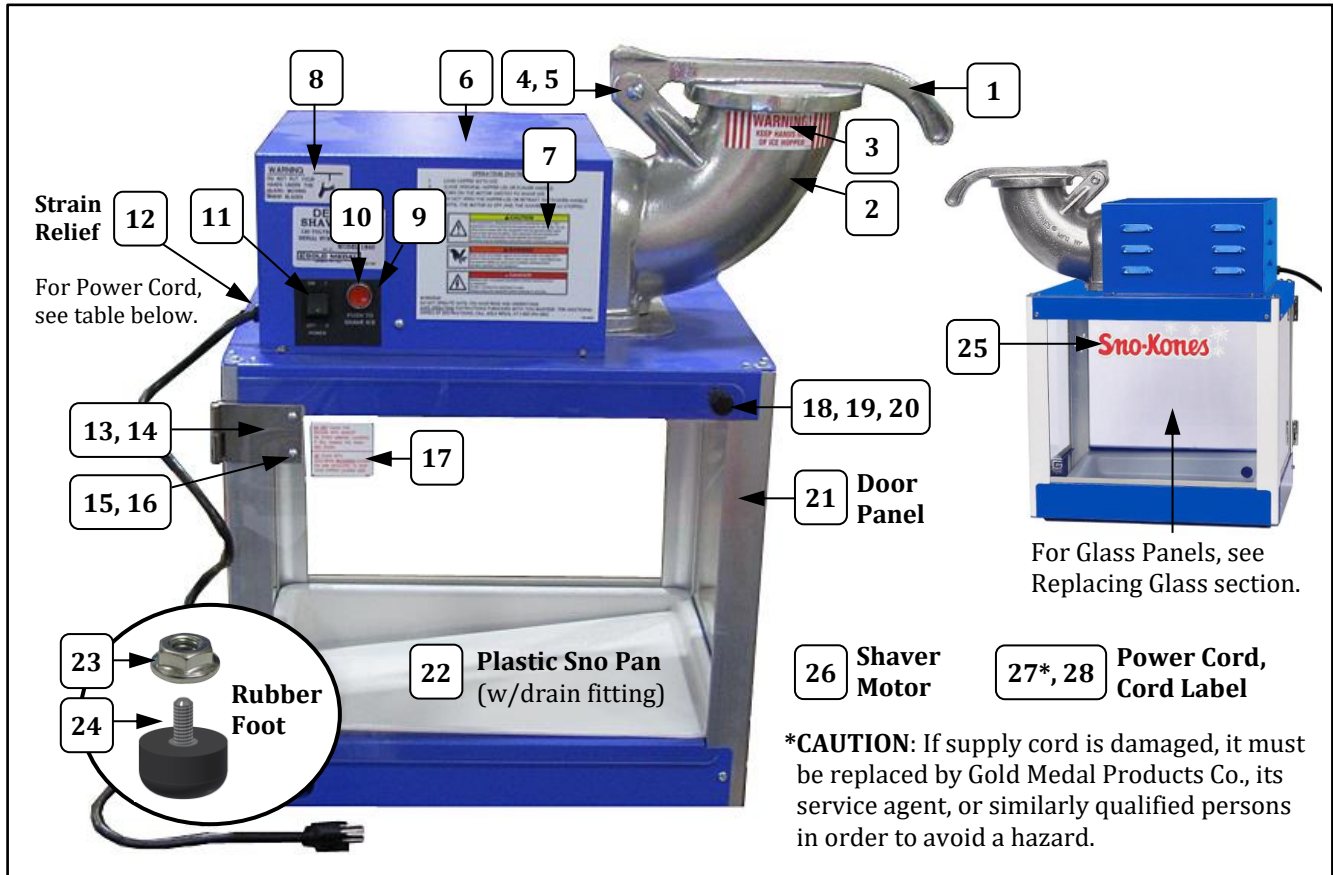

Item	Part Description	Part Number
		All Models
1	PUSHER HANDLE (replacement)	22068
2	HOPPER CASTING	22009
3	WARNING LABEL	44018
4	5/16-18 X 2 PH PAN HD M/S	12059
5	5/16-18 SERRATED LOCK NUT	49317
6	MOTOR COVER SNO KONE BLUE	61111B
7	OPERATON WARNING LABEL	44019
8	GUARD WARNING LABEL	44027
9	SWITCH LABEL	13141
10	MOMENTARY SWITCH	38971
11	SWITCH, DPST LIT ROCKER	42798
12	STRAIN RELIEF SR-6P3-4	76026
13	MALE HINGE SHORT LEFT	41349

Item	Part Description	Part Number
		All Models
14	LH FEMALE STEEL HINGE	61359
15	8-32 X 3/8 PH PAN W/SEMS	42227
16	ACORN NUT #8-32	47702
17	LABEL, DO NOT CLEAN.....	49393
18	KNOB 8-32	47120
19	8-32X1/2 FL HD PH MS	20066
20	MAGNET USES 8 FLT HD SC	50013
21	DOOR	23235
22	SNO PAN PLASTIC	22701
23	8-32 SERRATED FLANGE NUT	61151
24	RUBBER BUMPER/FOOT	87247
25	DECAL SNO-KONE	12538

Item	Part Description	Part Number	
		1203-00-000	1203-01-000
26	1/4 HP MOTOR	55448	113002
27*	POWER SUPPLY CORD	22038	42369
28	WARNING LABEL CORD	68720	68720



Shaver Head and Accessories

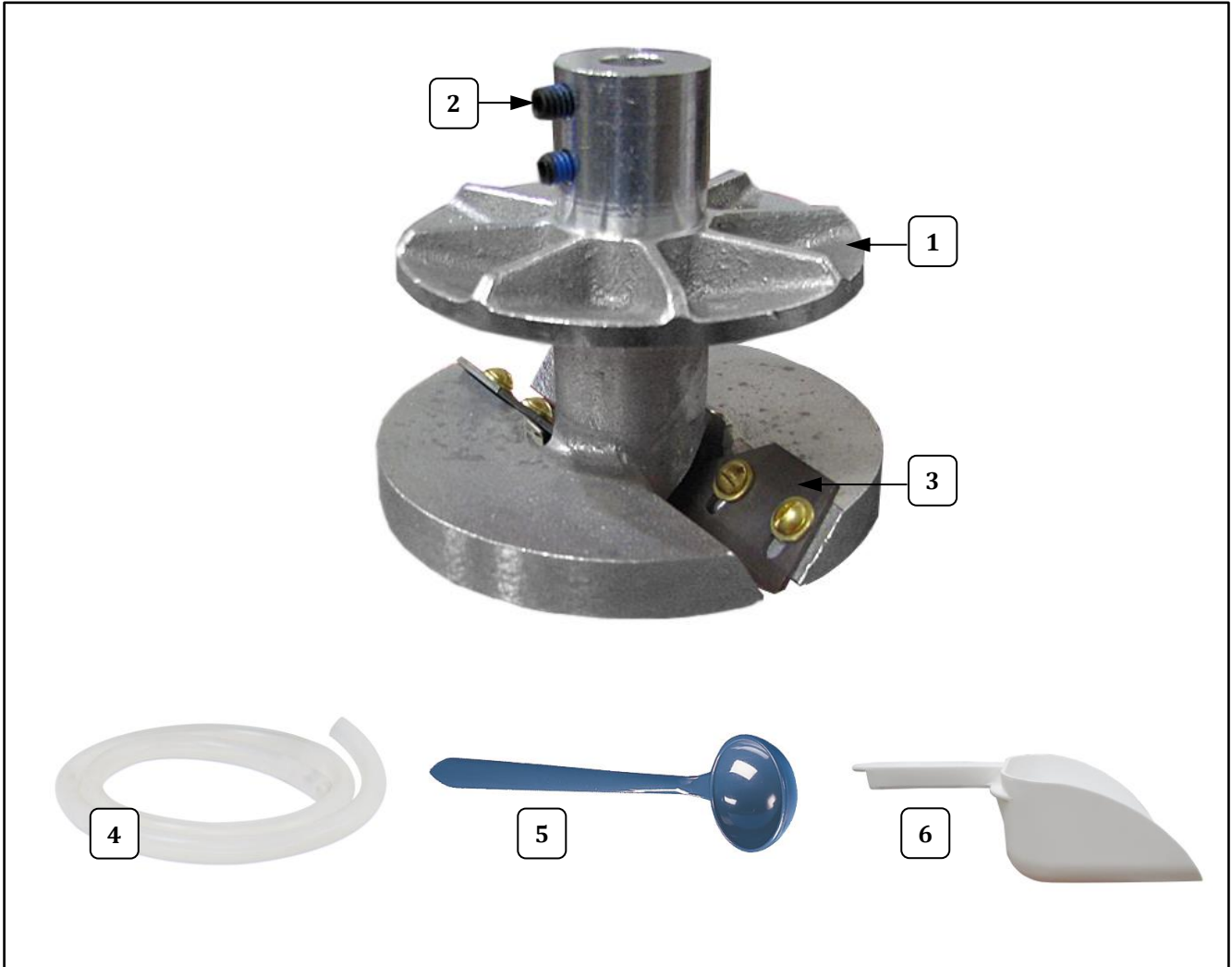

Item	Part Description	Part Number
1	SHAVER HEAD	22015
2	1/4-20 X 3/8 SET SC	69703
3	2 HOLE BLADE REPLACE SET (includes 2 blades, washers, and screws)	22017
4	DRAIN HOSE 3/4 ID 7/8 OD (sold by the foot)	12159
5	PLASTIC SNOW DIPPER	1088
6	ICE SCOOP	39068



Wiring Diagram

Model 1203-00-000

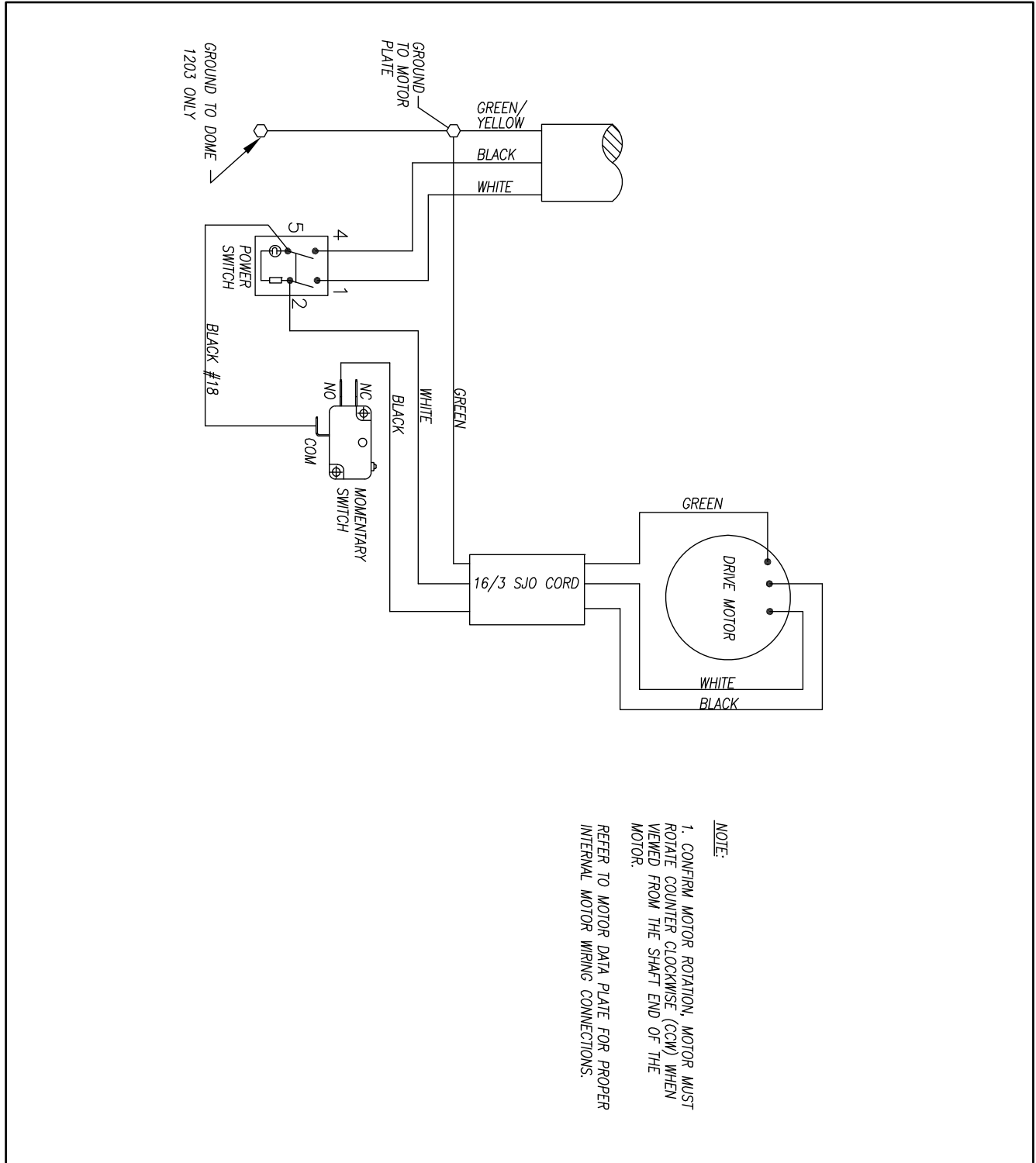



Model 1203-01-000

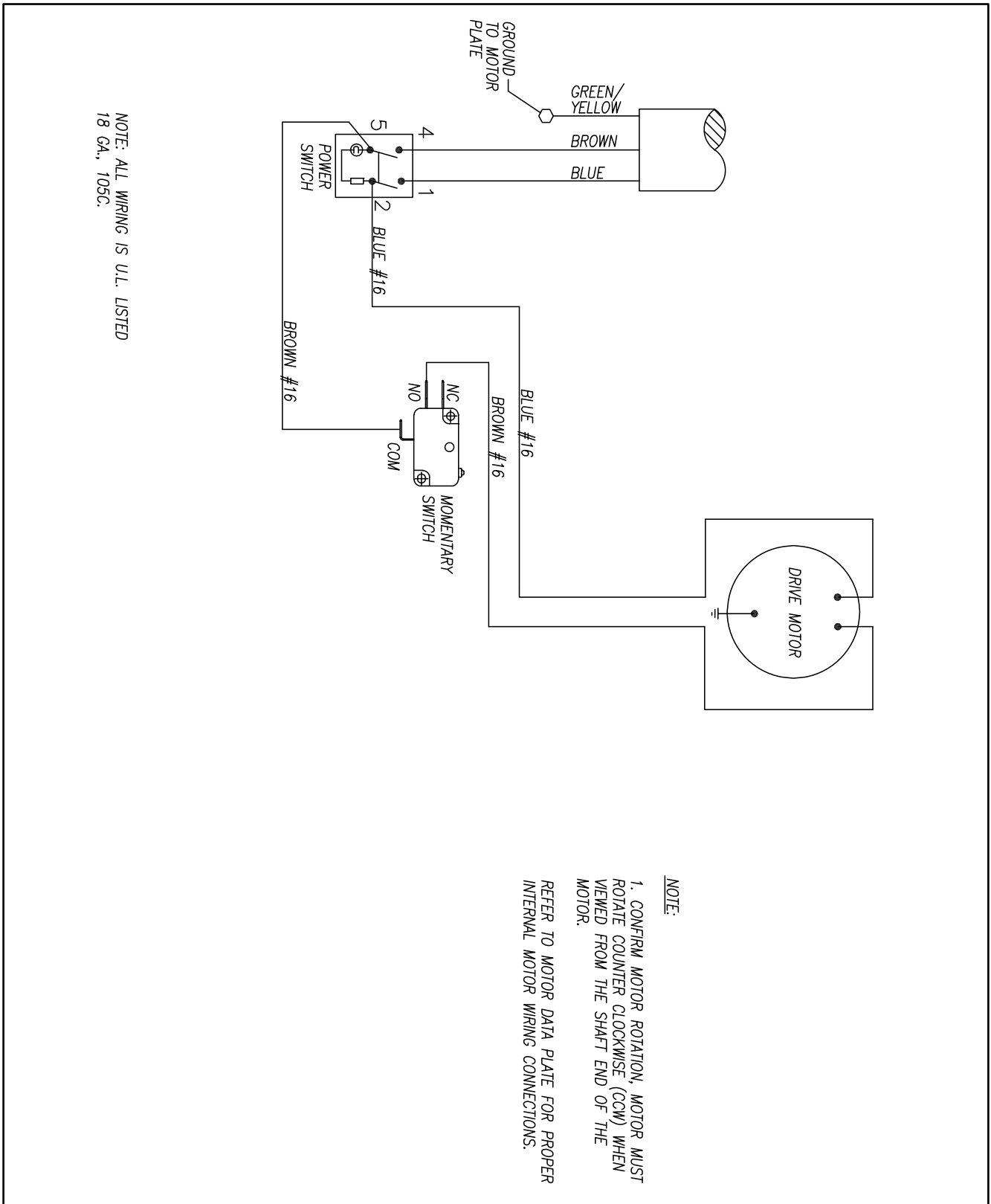



WARRANTY

Gold Medal Products Co. warrants to the original purchaser each item of its manufacture to be free of defects in workmanship and material under normal use and service. Gold Medal Products Co.'s obligation under this warranty is limited solely to repairing or replacing parts, f.o.b. Cincinnati, Ohio, which in its judgment are defective in workmanship or material and which are returned, freight prepaid, to its Cincinnati, Ohio factory or other designated point. Except for "Perishable Parts" on specific machines, the above warranty applies for a period of two (2) years from the date of original sale to the original purchaser of equipment when recommended operating instructions and maintenance procedures have been followed. These are packed with the machine. Parts warranty is two (2) years, labor is six (6) months.

THIS WARRANTY IS IN LIEU OF ALL OTHER WARRANTIES EXPRESSED OR IMPLIED, AND OF ALL OTHER OBLIGATIONS OR LIABILITIES ON OUR PART, INCLUDING THE IMPLIED WARRANTY OF MERCHANTABILITY. THERE ARE NO WARRANTIES WHICH EXTEND BEYOND THE DESCRIPTION ON THE FACE HEREOF. In no event shall Gold Medal Products Co. be liable for special, incidental or consequential damages. No claim under this warranty will be honored if the equipment covered has been misused, neglected, damaged in transit, or has been tampered with or changed in any way. No claim under this warranty shall be honored in the event that components in the unit at the time of the claim were not supplied or approved by Gold Medal Products Co. This warranty is effective only when electrical items have been properly attached to city utility lines only at proper voltages. This warranty is not transferable without the written consent of Gold Medal Products Co.

The term "Original Purchaser" as used in this warranty shall be deemed to mean that person, firm, association, or corporation who was billed by the GOLD MEDAL PRODUCTS CO., or their authorized distributor for the equipment.

THIS WARRANTY HAS NO EFFECT AND IS VOID UNLESS THE ORIGINAL PURCHASER FIRST CALLS GOLD MEDAL PRODUCTS CO. AT 1-800-543-0862 TO DISCUSS WITH OUR SERVICE REPRESENTATIVE THE EQUIPMENT PROBLEM, AND, IF NECESSARY, FOR INSTRUCTIONS CONCERNING THE REPAIR OR REPLACEMENT OF PARTS.

NOTE: This equipment is manufactured and sold for commercial use only.



GOLD MEDAL[®] PRODUCTS CO.

10700 Medallion Drive, Cincinnati, Ohio 45241-4807 USA

gmpopcorn.com

Phone: (800) 543-0862 Fax: (800) 542-1496
(513) 769-7676 (513) 769-8500

© 2022 – The text, descriptions, graphics, layout, and other material in this publication are the exclusive property of Gold Medal Products Co. and shall not be used, copied, reproduced, or published in any fashion, including website display, without its express written consent.