



# Instruction Manual

## Kingery®/Deluxe 60 Special Poppers

Model No. 1871, 2660, 2660A, 2660ST



Model 1871



Models 2660, 2660A



**GOLD MEDAL® PRODUCTS CO.**

10700 Medallion Drive, Cincinnati, Ohio 45241-4807 USA



# SAFETY PRECAUTIONS

	<b>⚠ DANGER</b>
	<p>Machine must be properly grounded to prevent electrical shock to personnel. Failure to do so could result in serious injury, or death. DO NOT immerse any part of this equipment in water. DO NOT use excessive water when cleaning. Keep cord and plug off the ground and away from moisture. Always unplug the equipment before cleaning or servicing. Make sure all machine switches are in the OFF position before plugging the equipment into the receptacle.</p> <p>008_051514</p>

	<b>⚠ DANGER</b>
	<p>Improper installation, adjustment, alteration, service, or maintenance can cause property damage, injury, or death. Any alterations to this equipment will void the warranty and may cause a dangerous condition. NEVER make alterations to this equipment. Read the Installation, Operating, and Maintenance Instructions thoroughly before installing, servicing, or operating this equipment.</p> <p>014_051514</p>

	<b>⚠ WARNING</b>
	<p>To avoid burns, DO NOT touch the kettle or any heated surface. DO NOT place or leave objects in contact with heated surfaces.</p> <p>013_092414</p>



	<b>⚠ WARNING</b>
	<p>ALWAYS wear safety glasses when servicing this equipment.</p> <p>010_010914</p>

	<b>⚠ WARNING</b>
	<p>No user serviceable parts inside. Refer servicing to qualified service personnel.</p> <p>011_051514</p>

	<b>⚠ WARNING</b>
	<p>Read and understand operator's manual and all other safety instructions before using this equipment. To order copies of the operator's manual go to <a href="http://gmpopcorn.com">gmpopcorn.com</a> or write to Gold Medal Products Co., 10700 Medallion Drive, Cincinnati, OH 45241 USA 1-(800)-543-0862</p> <p>022_060215</p>



## SAFETY PRECAUTIONS (continued)

	 <b>WARNING</b>
	DO NOT allow direct contact of this equipment by the public when used in food service locations. Only personnel trained and experienced in the equipment operation may operate this equipment. Carefully read all instructions before operation. <span style="float: right;">012_010914</span>

	 <b>WARNING</b>
	This machine is NOT to be operated by minors. <span style="float: right;">007_010914</span>

**Note:** Improvements are always being made to Gold Medal's equipment. This information may not be the latest available for your purposes. It is critical that you call Gold Medal's Technical Service Department at 1-800-543-0862 for any questions about your machine operations, replacement parts, or any service questions. (Gold Medal Products Co. does not assume any liability for injury due to careless handling and/or reckless operation of this equipment.)



# INSTALLATION INSTRUCTIONS

## Inspection of Shipment

After unpacking, check thoroughly for any damage which may have occurred in transit. Claims should be filed immediately with the transportation company. The warranty does not cover damage that occurs in transit, or damage caused by abuse, or consequential damage due to the operation of this machine, since it is beyond our control (reference warranty in back of manual).

## Manual

Read and understand the operator's manual and all other safety instructions before using this equipment. To order copies of the operator's manual go to [gmpopcorn.com](http://gmpopcorn.com) or write to Gold Medal Products Co., 10700 Medallion Drive, Cincinnati, OH 45241 USA 1-(800)-543-0862.

## Model Description

**1871:** Kingery 6 oz. Popper, unit has a bronze dome and frame, and etched glass.

**2660:** Deluxe Sixty Special 6 oz. Popper, unit has a red dome.

**2660A:** Deluxe Sixty Special 6 oz. Popper, unit has a red dome and is equipped with a PowerOff™ Control feature.

**2660ST:** Deluxe Sixty Special 6 oz. Popper, unit has a stainless steel dome.

## Items Included with this Unit



## Setup

This unit has been tested at the factory.

1. Remove all packaging and tape prior to operation.
2. Place the unit on a sturdy, level base.
3. The popper unit has 4 glide feet preinstalled at the factory (see image below). Install a Black Crutch Tip on each of the 4 glide feet. Firmly push the crutch tip over the glide until it covers the glide entirely.
4. Door knobs are shipped in the accessories pack located inside the machine. Install a door knob with tee bolt on each popper door; install the knob with screw on the old maid pan.
5. Carefully install the light bulb (do not over-tighten) into the lamp holder located in the cabinet interior. Ensure the unit is OFF and unplugged before installing or changing the bulb (reference the Electrical Requirements section).
6. Make sure kettle lead-in cord is securely plugged into unit, and twisted to lock into the kettle receptacle.

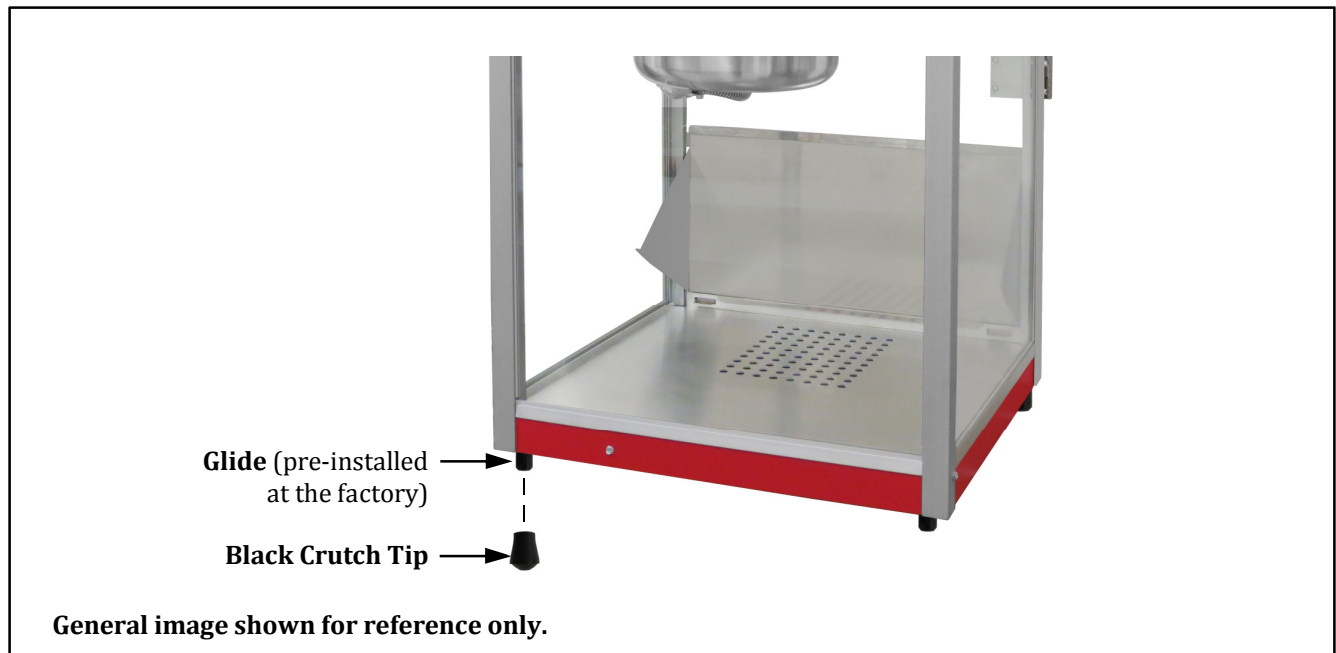





## Electrical Requirements

The following power supply must be provided:

**1871, 2660, 2660A, 2660ST:** 120 V~, 1220 W, 60 Hz

	 <b>DANGER</b>
	<p>Machine must be properly grounded to prevent electrical shock to personnel. Failure to do so could result in serious injury, or death. DO NOT immerse any part of this equipment in water. DO NOT use excessive water when cleaning. Keep cord and plug off the ground and away from moisture. Always unplug the equipment before cleaning or servicing. Make sure all machine switches are in the OFF position before plugging the equipment into the receptacle.</p> <p>008_051514</p>

A certified electrician must furnish sufficient power for proper machine operation and install any supplied receptacle. We recommend this equipment be on a dedicated and protected circuit. Failure to wire properly will void the warranty and may result in damage to the machine. It is Gold Medal Products Co.'s recommendation that this machine be plugged directly into a wall outlet. The use of extension cords is not recommended due to safety concerns, and may cause sacrificed and/or reduced performance. Make sure cord is located to prevent a trip hazard or unit upset.

## Before You Plug In Machine

1. Make sure all machine switches are in the OFF position before plugging the equipment into the receptacle.
2. Make sure the wall outlet can accept the grounded plugs (where applicable) on the power supply cord.
3. The wall outlet must have the proper polarity. If in doubt, have a competent electrician inspect the outlet and correct if necessary.
4. DO NOT use a grounded to un-grounded receptacle adapter (where applicable).
5. Install the unit in a level position.

	 <b>CAUTION</b>
	<p>If the supply cord is damaged, it must be replaced by Gold Medal Products Co., its service agent or similarly qualified persons in order to avoid a hazard.</p> <p>039_080614</p>

# OPERATING INSTRUCTIONS

## Controls and Their Functions

### KETTLE HEAT SWITCH

Two position, ON/OFF lighted rocker switch - supplies power to the heating elements in the popping kettle. The green switch light ON indicates there is power to the kettle heating element.

### KETTLE MOTOR SWITCH

Two position, ON/OFF lighted rocker switch - supplies power to the kettle agitator motor. The Kettle Motor Switch **MUST** be ON at all times when there is popcorn (popped or unpopped) in the kettle. The green switch light ON indicates there is power to the agitator motor.

### LIGHTS/WARMER SWITCH

Two position, ON/OFF lighted rocker switch - supplies power to the interior cabinet light and heat element for the corn pan.

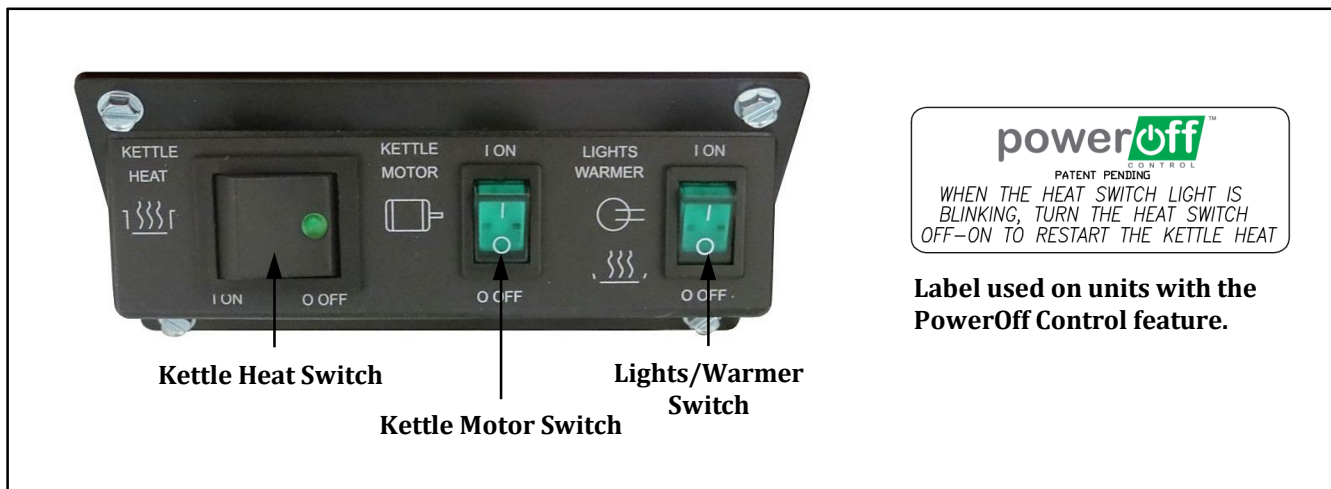

### POWEROFF CONTROL

The PowerOff Control feature will automatically turn the kettle heat off after 15 minutes of idle time (no popcorn popped). The PowerOff Control will prevent the heat element and thermostat from cycling OFF-ON if the Kettle Heat Switch is left on. This feature saves electrical power and extends the life of the kettle heating element and thermostat.

- When the Kettle Heat Switch is turned ON, and the kettle thermostat switches OFF, the PowerOff Control's 15 minute timer starts; the 15 minute timer resets each time a batch of popcorn is popped.
- The small green neon light in the Kettle Heat Switch will blink OFF-ON to indicate the kettle has been automatically turned OFF.
- To restart the kettle heating, cycle the Kettle Heat Switch OFF-ON.



# Popping Corn

This section describes instructions for popping Standard (salted popcorn).

## Amount of Popcorn and Oil

The popper is equipped with a corn, salt, and oil measure. We recommend flavored and colored coconut oil. Popcorn popped in coconut oil stays fresh longer and does not leave black deposits in your kettle like other oils. Use only top quality, fresh popcorn from reputable suppliers.

### Ingredient amounts for popping Standard Popcorn:

Kettle Size	Popcorn Charge	Oil Charge	Flavacol (Salt)
6 oz.	6 oz. (177 ml)	2 oz. (59 ml)	1/2 Tblsp. (7.5cc)

For best results use Mega-Pop® 6 oz. premeasured pouches (Item# 2836).

## Popping Standard (Salted) Popcorn

1. Turn the Lights/Warmer, Kettle Heat and Kettle Motor Switches ON.
2. To determine when the kettle is ready to pop corn (about 4 minutes), test pop three kernels of corn and one ounce (30 ml) of popping oil. When the kernels pop, the kettle is ready for use.
3. Lift the kettle lid and load the Mega-Pop® premeasured popcorn and oil pouch into kettle, or pour in the popcorn and Flavacol, then add oil in the premeasured amounts specified above. Close lid.
4. When the corn has finished popping, gently dump the popcorn.
5. On the final kettle of corn, turn the Kettle Heat Switch OFF just as the lids are forced open by the popping corn. This procedure saves electricity, since the kettle has plenty of heat, and helps eliminate smoke/odor from any oil residue that remains after popping has stopped.
6. When finished popping, make sure KETTLE HEAT and KETTLE MOTOR switches are turned OFF.

### **NEVER LEAVE THE HEAT ON WHEN YOU ARE NOT POPPING CORN!**

If unit is equipped with the PowerOff Control feature, the unit will automatically shut kettle heat OFF after 15 minutes of idle time (no popcorn popped). To restart kettle heating, cycle the Heat Switch OFF-ON.

## Care and Cleaning

	<b>⚠ DANGER</b>
	<p>Machine must be properly grounded to prevent electrical shock to personnel. <b>DO NOT immerse in water.</b> Always unplug the equipment before cleaning or servicing.</p> <p style="text-align: right;">025_020314</p>

	<b>⚠ WARNING</b>
	<p>To avoid serious burns, <b>DO NOT</b> touch the kettle while it is hot!</p> <p style="text-align: right;">028_082715</p>

Good sanitation practice demands that all food preparation equipment be cleaned regularly (only use non-toxic, food grade cleaners). A clean looking, well-kept machine is one of the best ways of advertising your product.

**Note:** It is extremely important to follow all of the cleaning procedures, otherwise parts damage and equipment failure will result. The warranty does not cover parts that are damaged due to improper cleaning.

### Daily Kettle Cleaning Instructions

**CAUTION:** A hot kettle will cause burns if you touch it with your hand. Allow kettle to cool at least 1 hour before attempting to clean. **DO NOT** use ice or water to cool down a hot kettle! Severe kettle damage will result!

1. When cool, wipe the **outside** of the kettle with a clean, soft cloth. **DO NOT** use oven cleaners or abrasive materials as they will damage the kettle.
2. Every night, mix Gold Medal's Heat'n Kleen solution (Item No. 2095), 2 tablespoons per gallon of water. It is not necessary to use the entire gallon at once; only use enough to fill the kettle 1/2 inch deep.
3. Turn the kettle heat ON. When the water starts to boil, turn the kettle heat OFF.
4. Allow to cool for at least 1 hour, then dump the solution into a bucket and wipe the inside of the kettle with a clean cloth. Make sure all of the solution goes into the bucket; do not spill any in the interior of the machine.

For an extra dirty kettle, the process may be repeated; or, after turning the kettle heat OFF, allow solution to sit in the kettle overnight. The next morning, dump the solution into a bucket and wipe the inside of the kettle with a clean cloth.

5. With the unit OFF and unplugged, wipe the kettle lead cord with a clean SLIGHTLY damp cloth. **DO NOT get moisture into the kettle lead-in cord, severe damage will result.**



---

## Daily Unit Cleaning Instructions

1. With the machine OFF, unplug the unit and allow it to cool before attempting to clean.
2. Make sure to clean all pans/accessories in order to sanitize them before each use.
3. Take a clean, SLIGHTLY damp cloth and wipe excess grease from the glass and cabinet.
4. Wipe the stainless steel parts with a clean cloth and cleaner designed for stainless steel, such as Gold Medal Watchdog Stainless Cleaner (Item No. 2088).

**DO NOT** use oven cleaners or abrasive materials as they will damage parts of the machine.

5. Clean the glass panels with glass cleaner. Gold Medal Watchdog Glass Cleaner (Item No. 2588) is recommended.

Ammonia cleaners will damage the plastic doors. Use only non-ammonia cleaners, such as Gold Medal Watchdog Glass Cleaner (Item No. 2588).



# Troubleshooting

Issue	Possible Cause	Solution
<b>Power to the Unit</b>	A. Power to the Unit	A. Make sure the unit's power cord is plugged in.
<b>Kettle Does Not Heat</b>	A. Power to the Kettle  B. Kettle Heat Switch  C. PowerOff Control        D. Heating Element	A. Make sure kettle lead-in cord is plugged in and twisted to lock into the kettle receptacle.  B. Have a qualified service person check the voltage to and from the Kettle Heat Switch; if switch is defective, replace it.  C. Units with the PowerOff Control feature, kettle heat will automatically shut OFF after 15 minutes of idle time (no popcorn popped). The small green neon light in the Kettle Heat Switch will blink OFF-ON to indicate the kettle has been automatically turned OFF.  To restart kettle heating, cycle the Heat Switch OFF-ON. Reference the Controls and Their Functions section of this manual.  D. Heating element in the kettle may be burned out. Check with a qualified service person for inspection/repair.
<b>Long Popping Cycles</b> (Longer than 4 minutes for Salt Popcorn)	A. Low Voltage  B. Inadequate Supply Lines  C. Inferior Corn	A. If the machine is operated on low voltage, this could cause the kettle not to reach the proper operating temperature. Check with a qualified electrician.  B. Inadequately sized electrical supply lines or use of extension cord, in addition to being a fire hazard, would also prevent the kettle from reaching the proper operating temperature. Check with a qualified electrician.  C. Inferior quality corn would result in longer popping cycles. Use only top quality hybrid popcorn from reputable suppliers. Even then, if you let your corn pick up moisture or dry out, your popping cycles will be slow.
<b>Kettle Agitator Shaft not Rotating</b>	A. Kettle Motor Switch  B. Kettle Agitator Shaft/Stir Blade not rotating. <b>(Unit must be OFF, unplugged and cool prior to checking or adjusting the agitator assembly.)</b>	A. If the kettle agitator shaft is not rotating, <b>DO NOT</b> pop corn. Make sure the Kettle Motor Switch is ON. If the switch is ON, and the shaft is not rotating, the switch or motor may be faulty, contact qualified service personnel for inspection/repair.  B. If the kettle agitator shaft is not rotating, <b>DO NOT</b> pop corn. Check the clearance between the kettle bottom and the stir blade; it should be 1/32" (use a dime). To adjust, reference the Agitator Set Collar Adjustment section.

# Agitator Set Collar Adjustment

The following instructions describe how to properly adjust set collars on an agitator assembly with a floating stir rod.

## Steps to Adjust Set Collars

**Step 1:** Make sure machine is OFF and unplugged, then allow unit to cool completely before attempting to adjust the agitator height.

**Step 2:** Loosen the set screw in each set collar to be adjusted.

**Step 3:** With the kettle mounted in the popper, adjust the shaft so the Agitator's Spur Gear contacts half of the Drive Motor Spur Gear (reference Spur Gear Placement image at right). **DO NOT** set spur gears at full gear contact; it can cause binding as the kettle is dumped.

**Step 4:** Once shaft is positioned correctly, re-tighten the set screw in the set collar above the crossbar to secure in place.

**Step 5:** Adjust clearance between the bottom of the crossbar and the lower set collar to 1/32" (thickness of a dime); then re-tighten set screw to secure in place (see image below).

**Step 6:** Adjust set collar for agitator weight to be between 3/16" to 1/4" above the agitator weight. Once adjusted, re-tighten set screw to secure in place.

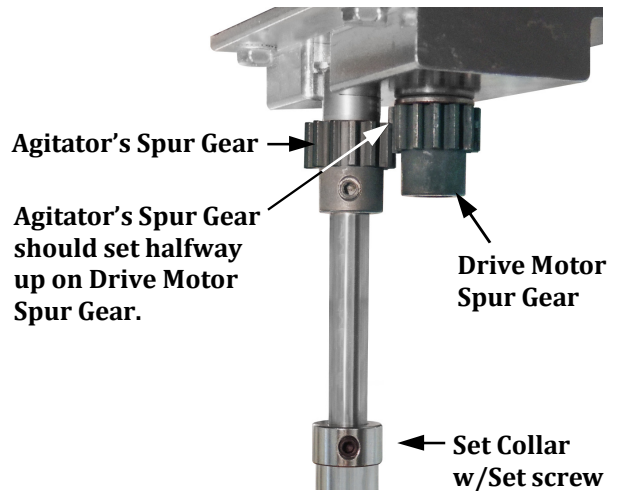

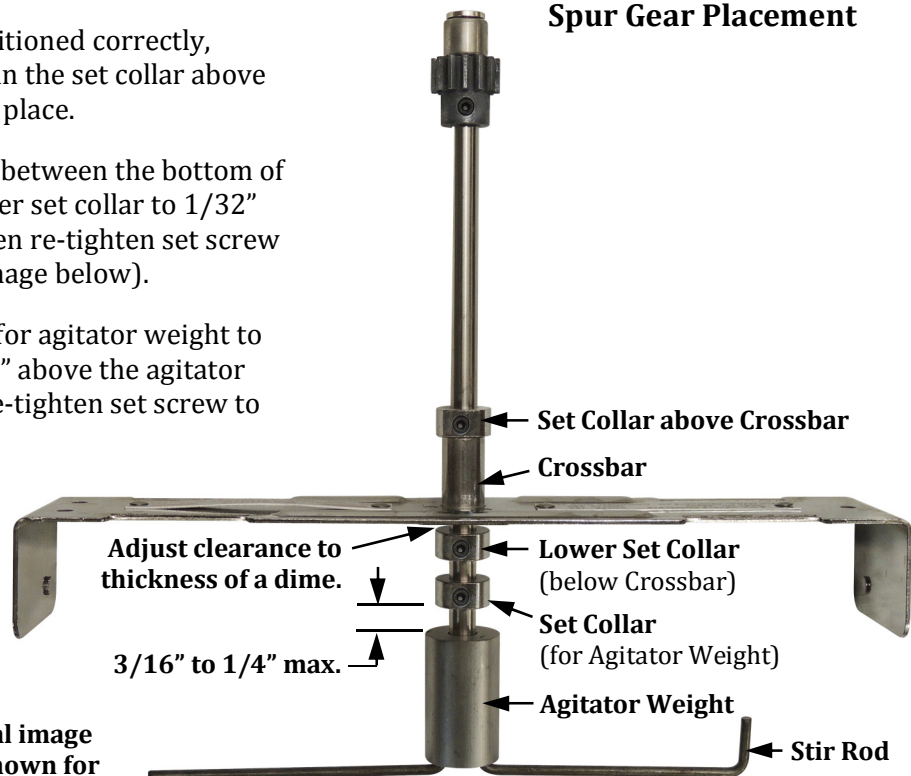

Spur Gear Placement







Agitator shown for general image reference only (lids not shown for clarity).





# MAINTENANCE INSTRUCTIONS

	 <b>DANGER</b>
	<p>Machine must be properly grounded to prevent electrical shock to personnel. Failure to do so could result in serious injury, or death. DO NOT immerse any part of this equipment in water. DO NOT use excessive water when cleaning. Keep cord and plug off the ground and away from moisture. Always unplug the equipment before cleaning or servicing. Make sure all machine switches are in the OFF position before plugging the equipment into the receptacle.</p> <p>008_051514</p>

	 <b>DANGER</b>
	<p>Improper installation, adjustment, alteration, service, or maintenance can cause property damage, injury, or death. Any alterations to this equipment will void the warranty and may cause a dangerous condition. NEVER make alterations to this equipment. Read the Installation, Operating, and Maintenance Instructions thoroughly before installing, servicing, or operating this equipment.</p> <p>014_051514</p>

	 <b>WARNING</b>
	<p>No user serviceable parts inside. Refer servicing to qualified service personnel.</p> <p>011_051514</p>

	 <b>CAUTION</b>
	<p>THE FOLLOWING SECTIONS OF THIS MANUAL ARE INTENDED ONLY FOR QUALIFIED SERVICE PERSONNEL WHO ARE FAMILIAR WITH ELECTRICAL EQUIPMENT. THESE ARE NOT INTENDED FOR THE OPERATOR.</p> <p>027_010914</p>



---

## ORDERING SPARE PARTS

1. Identify the needed part by checking it against the photos, illustrations, and/or parts list.
2. Use only approved replacement parts when servicing this unit.
3. When ordering, please include part number, part name, and quantity needed.
4. Please include your model number, serial number, and date of manufacture (located on the machine nameplate/data plate) with your order.
5. Address all parts orders to:

Parts Department  
Gold Medal Products Co.  
10700 Medallion Drive  
Cincinnati, Ohio 45241-4807

Or, place orders by phone or online:

Phone: (800) 543-0862  
(513) 769-7676  
Fax: (800) 542-1496  
(513) 769-8500  
E-mail: [info@gmpopcorn.com](mailto:info@gmpopcorn.com)  
Web Page: [gmpopcorn.com](http://gmpopcorn.com)

## Replacing Broken Glass

Broken glass panels can be easily replaced. Gold Medal Products Co. does not ship glass. It can be obtained from a local glass shop, always purchase tempered glass.

### GLASS DIMENSIONS (Height x Width x Thickness)

**Front Glass:** 22 1/2" X 15 1/8" X 1/8" (1 Piece)

**Side Glass:** 22 1/2" X 13" X 1/8" (2 Pieces)

1. With the machine OFF, unplug the unit and allow it to cool before attempting to replace any glass.
2. Carefully remove all loose pieces of broken glass.
3. Lift out the Corn Pan (see Figure A).
4. Locate the Glass Retainer Strips holding in the glass panel, remove the screws to unfasten the retainers (see Figure A). Carefully remove the rest of the broken glass. Remove all rigid glass channels from around the glass to be replaced, set channels aside for reuse.

### To remove the Glass Strip with the Cover:

- Bend out the tabs at the bottom and top of Glass Strip (see Figure A).
  - Pinch in the edge of the Glass Strip Cover just enough to rotate the cover out of the Glass Strip, then remove (see Figure B).
  - Remove the Glass Strip. When reinstalling, ensure the wiring is on top of the Glass Strip (as seen in Figure C).
5. Apply decals (if desired) to the new glass panel.
  6. Slide the rigid glass channels over the exposed sides and bottom of the new glass panel.
  7. Fasten new glass panel in machine with the existing Glass Strips and screws using the steps above as reference.

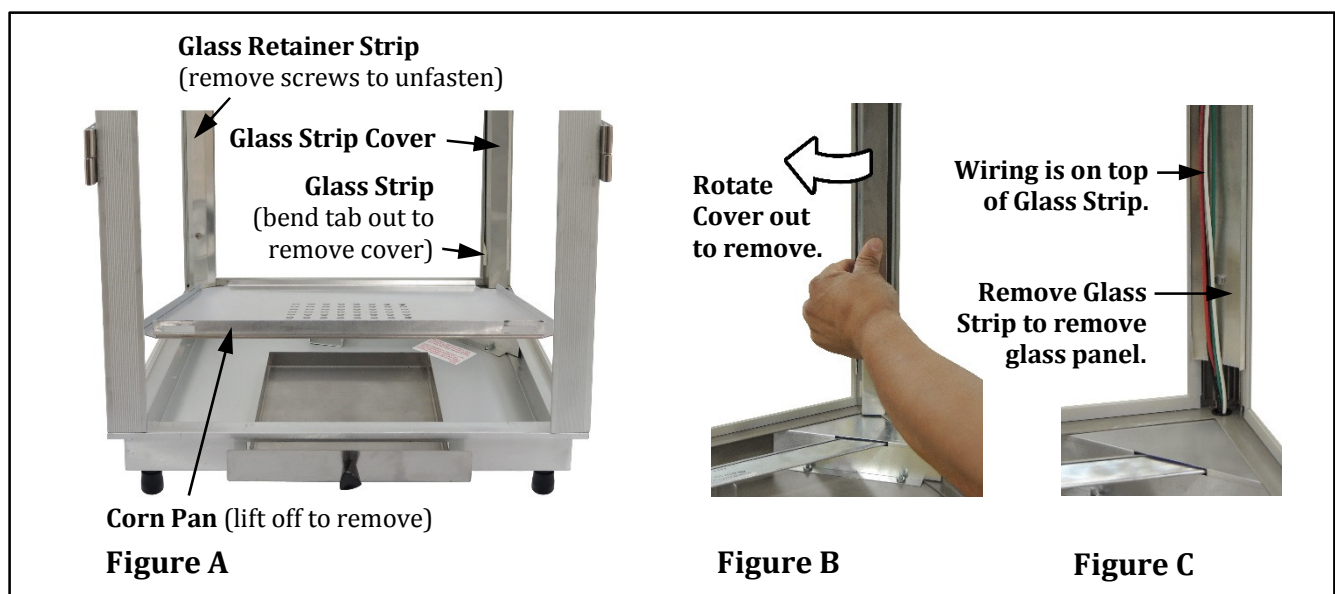



# Kettle Assembly – 56000 – Parts Breakdown

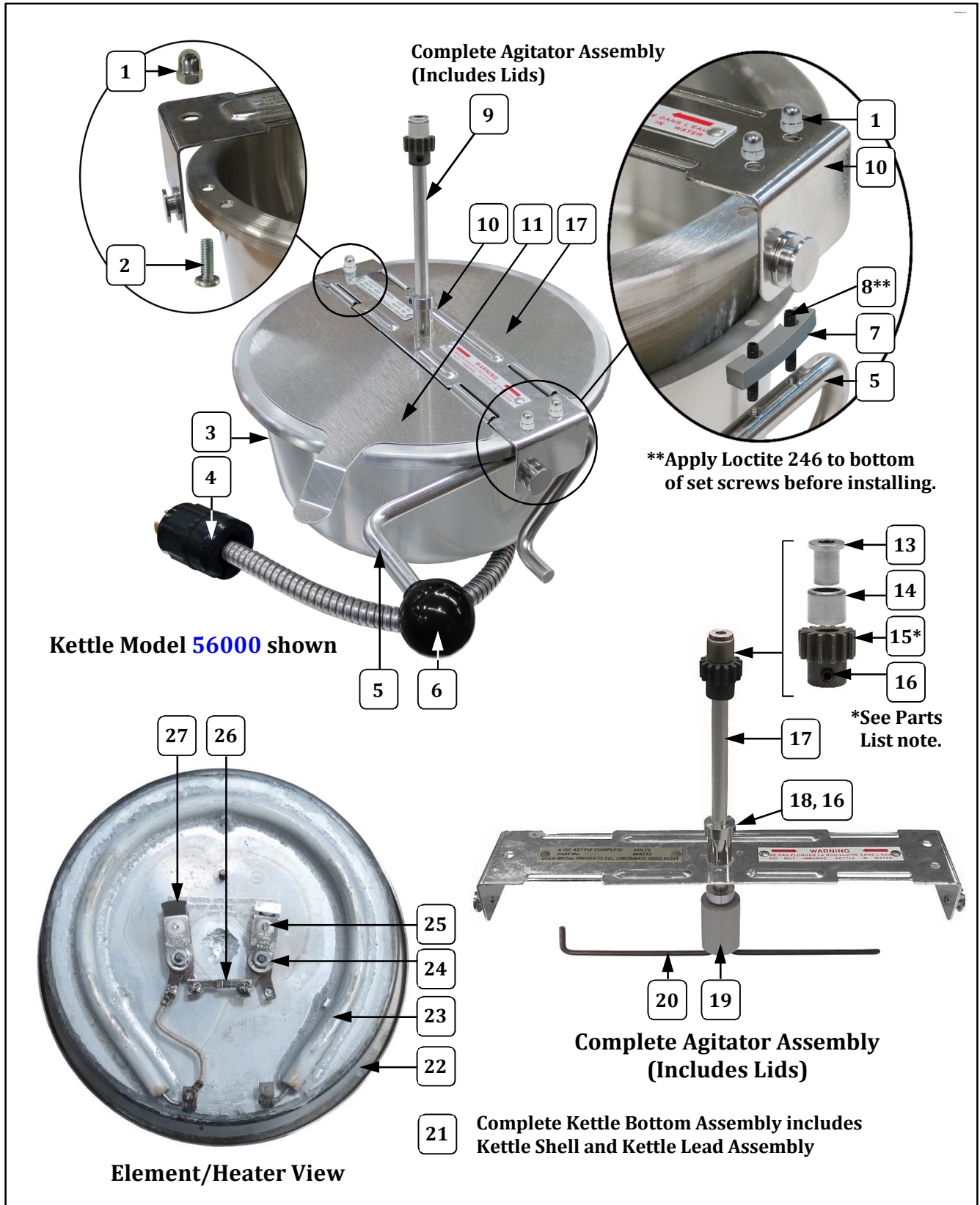



## Kettle Assembly – 56000 – Parts List

Item	Part Description	Part Number
		56000
1	8-32 TALL ACORN NUT	47702
2	8-32 X 1/2 PHIL PAN M/S	47141
3	KETTLE SHELL	49431
4	KETTLE LEAD ASSY	49328
5	DUMP HANDLE RH	49314
6	DUMP HANDLE KNOB	47110
7	SPACER (for Dump Handle)	49362
8	8-32 X 1" SET SCREW	77933
9	LID & AGITATOR ASSY (Complete Assembly)	59103
10	KETTLE CROSSBAR ASSEMBLY	59102
11	FRONT LID W/FORMED LIFTER	49017
12	REAR KETTLE LID	49016
13	AGITATOR BEARING HUB	43434
14	NEEDLE BEARING	47106
15*	SPUR GEAR KIT (Includes 2 gears with set screws. Always replace Agitator Spur Gear and Kettle Drive Motor Gear as a set.)	47059K
16	SET SCREW #10-32 X 3/16	41742
17	AGITATOR SHAFT	69710
18	SET COLLAR 5/16 ID 5/8 OD	46649
19	AGITATOR WEIGHT	69715
20	STIR ROD	69714
<b>Kettle Bottom Assembly – Element/Heater View</b>		
21	KETTLE BOTTOM ASSEMBLY (Complete Assembly - includes Kettle Shell, Kettle Lead Assembly and parts listed below)	56000W
22	KETTLE GASKET	49368
23	KETTLE/HEATER	56006
24	8-32 TOP LOCK NUT (where used, always replace lock nut if removed)	67943
25	450°F THERMOSTAT (includes two 6-32 X 3/16 Screws)	76089
26	THERMOSTAT SHUNT BAR	47193
27	525°F THERMOSTAT (includes two 6-32 X 3/16 Screws)	76702

## Cabinet Exterior – Front View

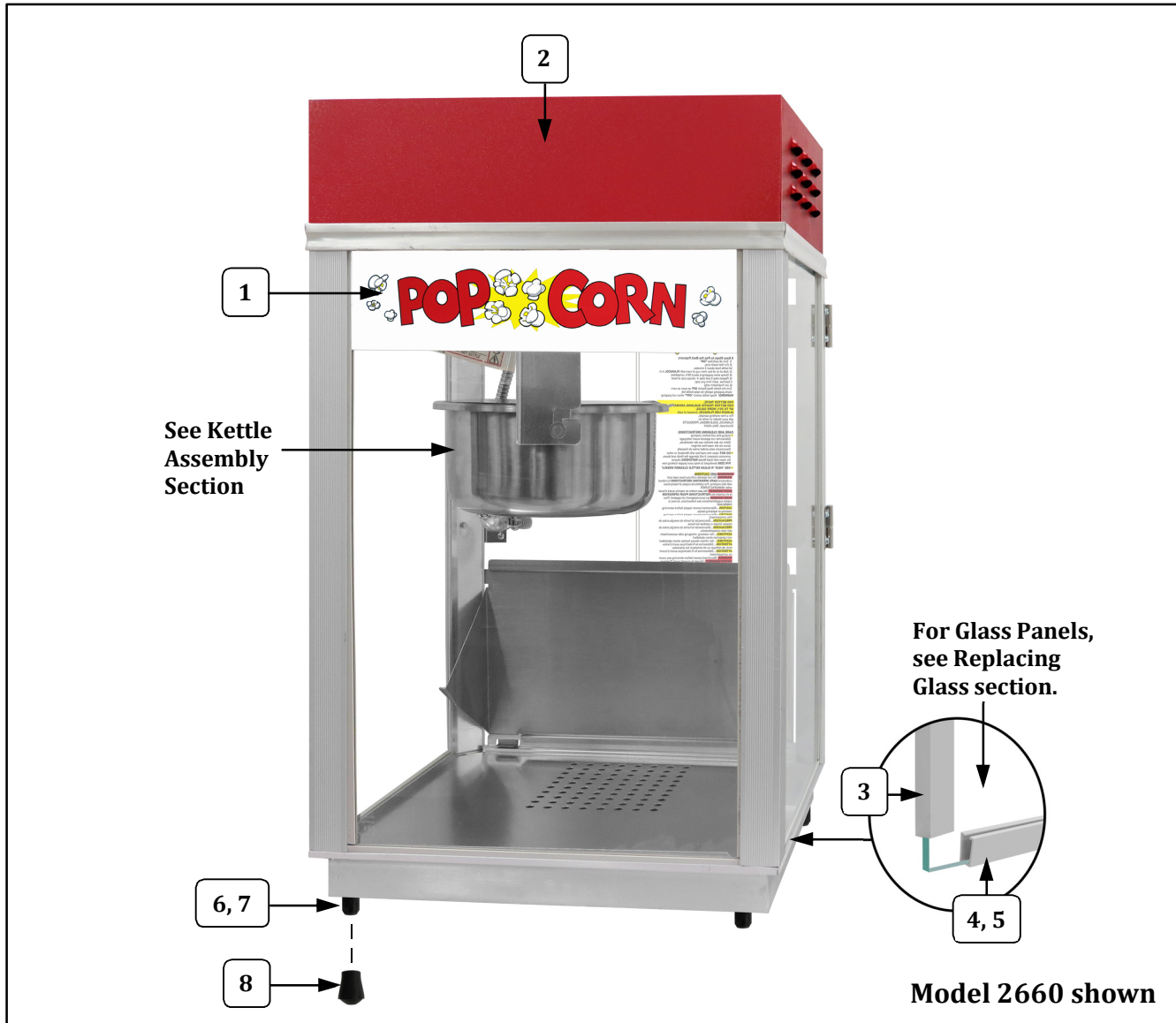

Item	Part Description	Part Number			
		1871	2660	2660A	2660ST
1	FRONT GLASS DECAL		49158	49158	49158
2	DOMES	49583	49456	49456	49581
3	22 1/8" GLASS CHANNEL (used on side edges of front and side glass panels)	49212	49212	49212	49212
4	13 1/8" GLASS CHANNEL (used on bottom edge of side glass panels)	49213	49213	49213	49213
5	15 1/8" GLASS CHANNEL (used on bottom edge of front glass panels)	49214	49214	49214	49214
6	GLIDE	47328	47328	47328	47328
7	10-24 X 3/4 HEX HD	41314	41314	41314	41314
8	BLACK CRUTCH TIP	49123	49123	49123	49123

## Cabinet Exterior – Rear View

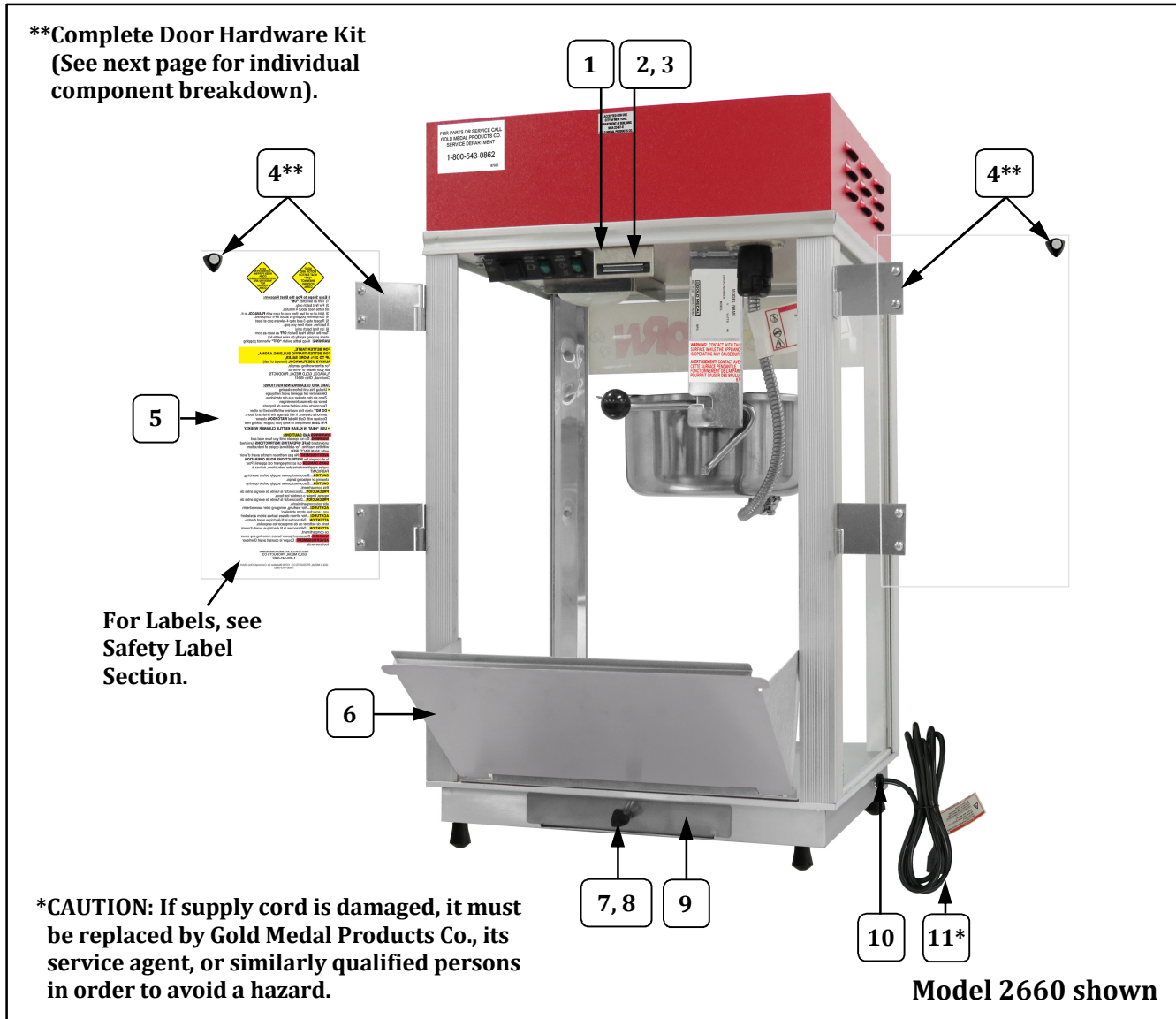

Item	Part Description	Part Number
		All Models
1	MAGNETIC BRACKET SHIM	38527
2	MAGNETIC CATCH BRACKET	77089
3	MAGNETIC CATCH	47561
4**	COMPLETE DOOR HARDWARE KIT	61380
5	PLEXIGLASS DOOR	49396
6	DROP PANEL	49210
7	KNOB LID LIFT	47120
8	8-32" X 3/8" PH PAN W/SEMS	42227
9	OLD MAID PAN	49100
10	#SR-6P3-4 STRAIN RELIEF	76026
11	LEAD-IN CORD 15 AMP PLUG	22038

## Door Hardware Kit **61380** – Individual Component Breakdown

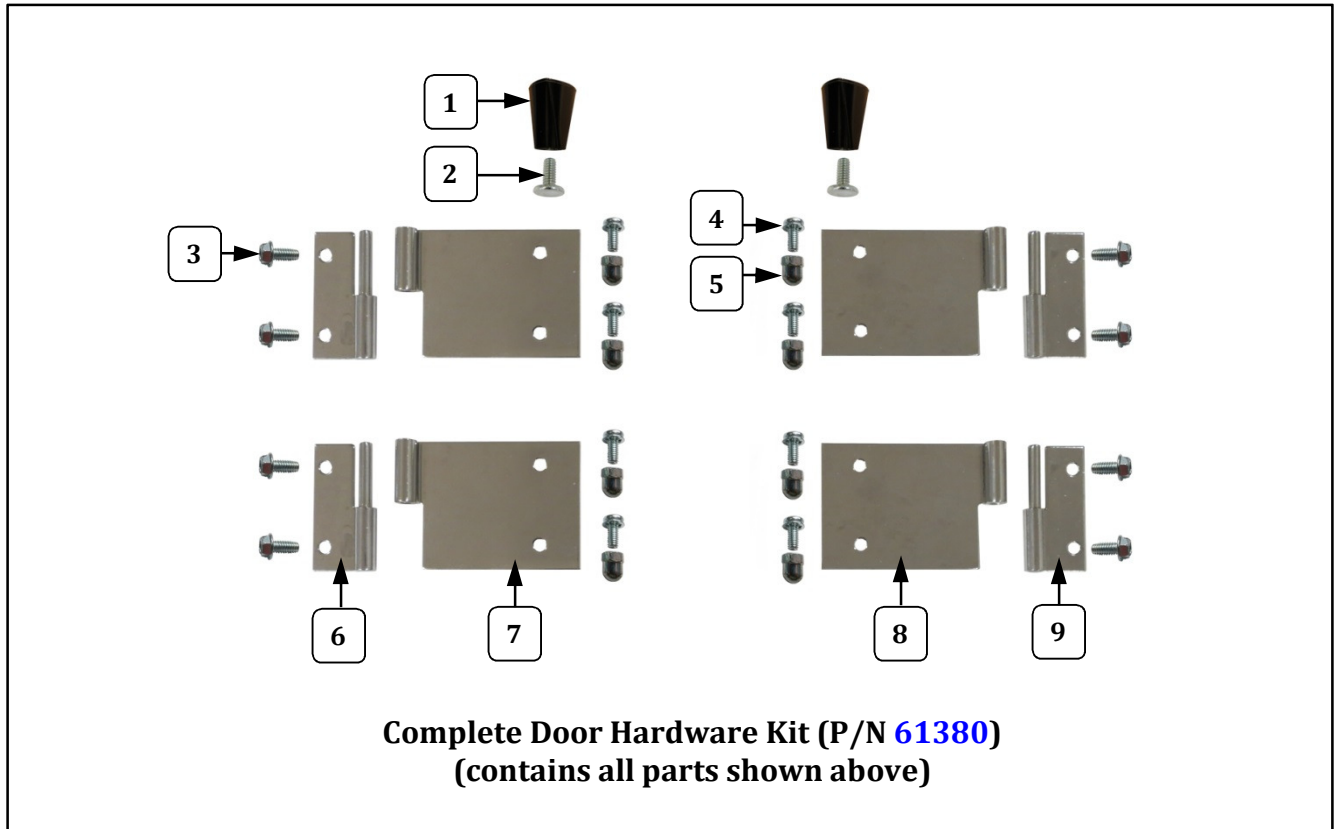

Item	Part Description	Part Number
		<b>61380</b>
1	KNOB LID LIFT	47120
2	TEE BOLT	75267
3	8-32 X 5/16 SLOTTED HEX	49594
4	8-32 X 3/8 PH PAN W/SEMS	42227
5	ACORN NUT #8-32	47702
6	MALE HINGE SHORT LEFT	41349
7	FEMALE HINGE LEFT HAND	61359
8	FEMALE HINGE RIGHT HAND	61373
9	MALE HINGE SHORT RIGHT	41350

## Cabinet Interior – Hanger Assembly

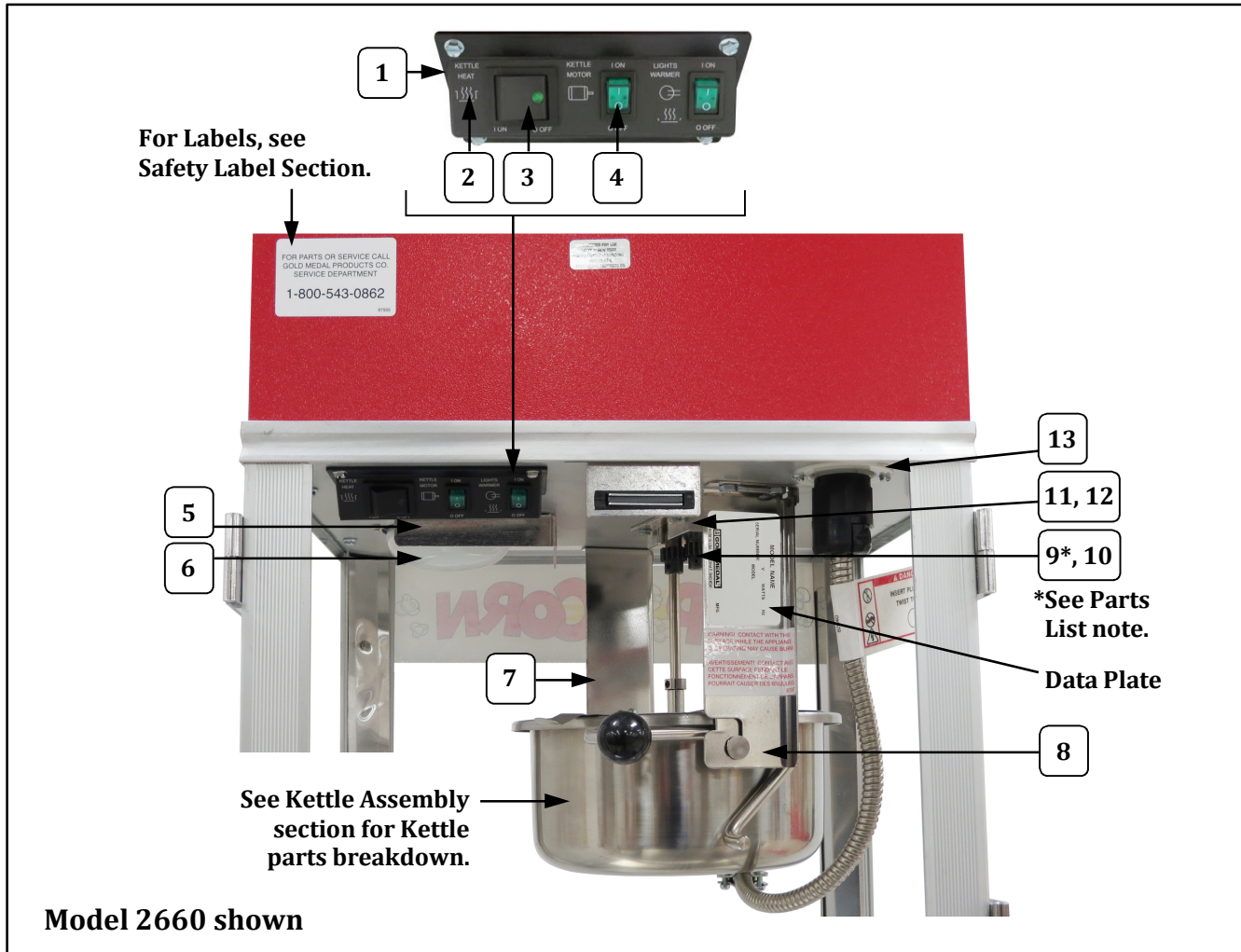

Model 2660 shown

Item	Part Description	Part Number
		All Models
1	SWITCH BOX	48501
2	SWITCH BOX LABEL	48502
3	GREEN LIGHTED ROCKER SWITCH	42798
4	DPST ROCKER SWITCH	42532
5	LIGHT SHIELD ANGLE	47799
6	65 WATT REFLECTOR FLOOD	41671
7	REAR HANGER ARM	49009
8	FRONT HANGER ARM	49010
9*	SPUR GEAR KIT (Includes 2 gears with set screws. Always replace Agitator Spur Gear and Kettle Drive Motor Gear as a set.)	47059K
10	10-32" X 3/16" SET SCREW	41742
11	GEAR BLOCK ASSEMBLY	67194
12	10-24 X 1 HEX MACH SCREW (fastens the gear block assembly to the kettle drive motor.)	49322
13	15 AMP TWIST LOCK KETTLE RECPT	49330



## Cabinet Interior – Corn Pan/Element View

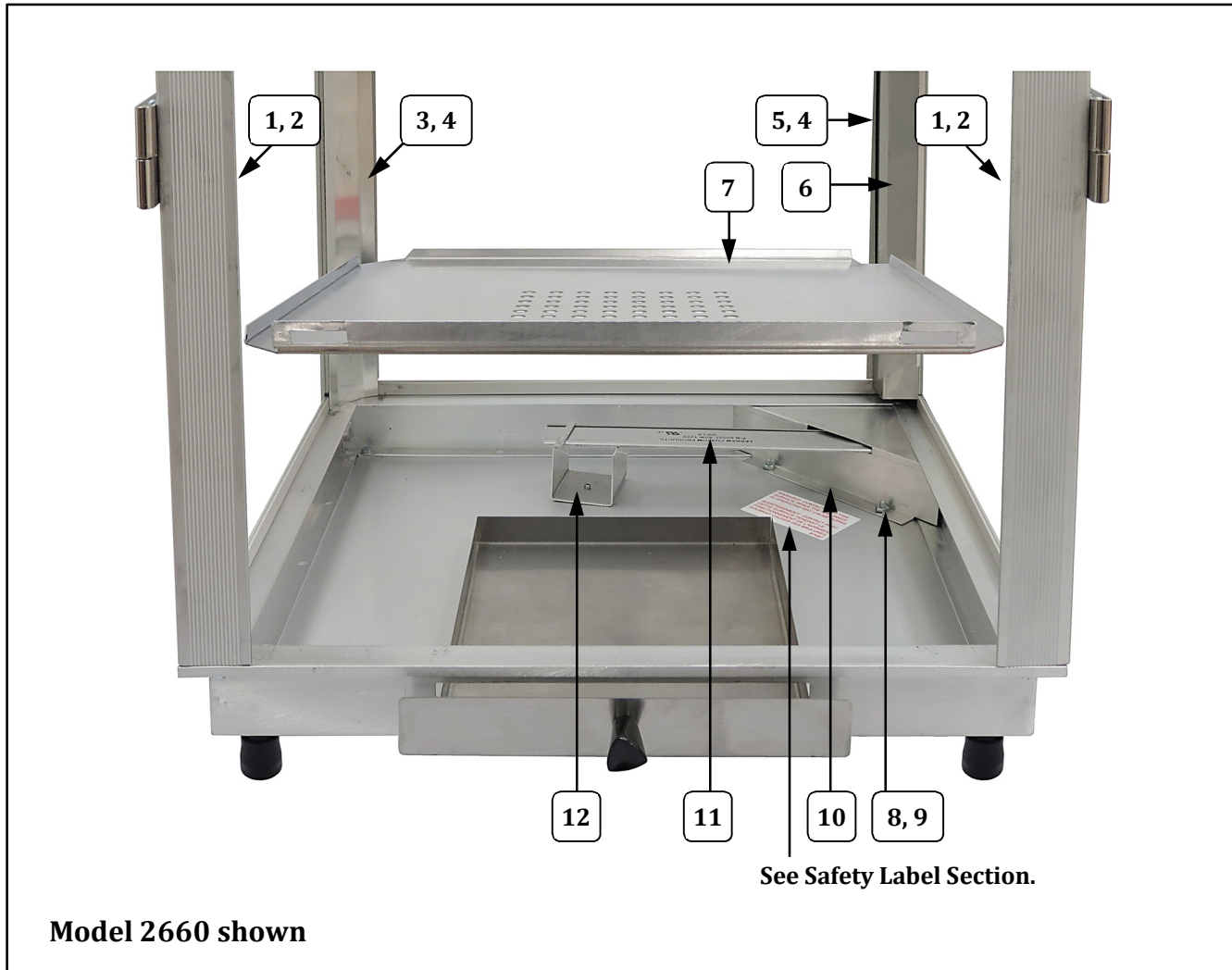

Item	Part Description	Part Number
		All Models
1	GLASS RETAIN STRIP, REAR	49215
2	8-32 X 1 UNSL NON-IND HWH (holds retainer)	39008
3	GLASS RETAIN STRIP, FRONT	49216
4	8-32 X 1 UNSL NON-IND HWH (holds retainer)	12008
5	GLASS STRIP (beneath the glass strip cover)	49318
6	GLASS STRIP COVER (covers wiring)	49319
7	CORN PAN	49211
8	HEX NUT #8-32 STAINLESS	89129
9	8-32 x 3/8 SLOTTED HEX	67899
10	WIRING GUARD	49201
11	120 VOLT 50 WATT HEAT ELEMENT	40031
12	STRIP HEATER BRACKET	49425



## Dome Interior – Electrical Components

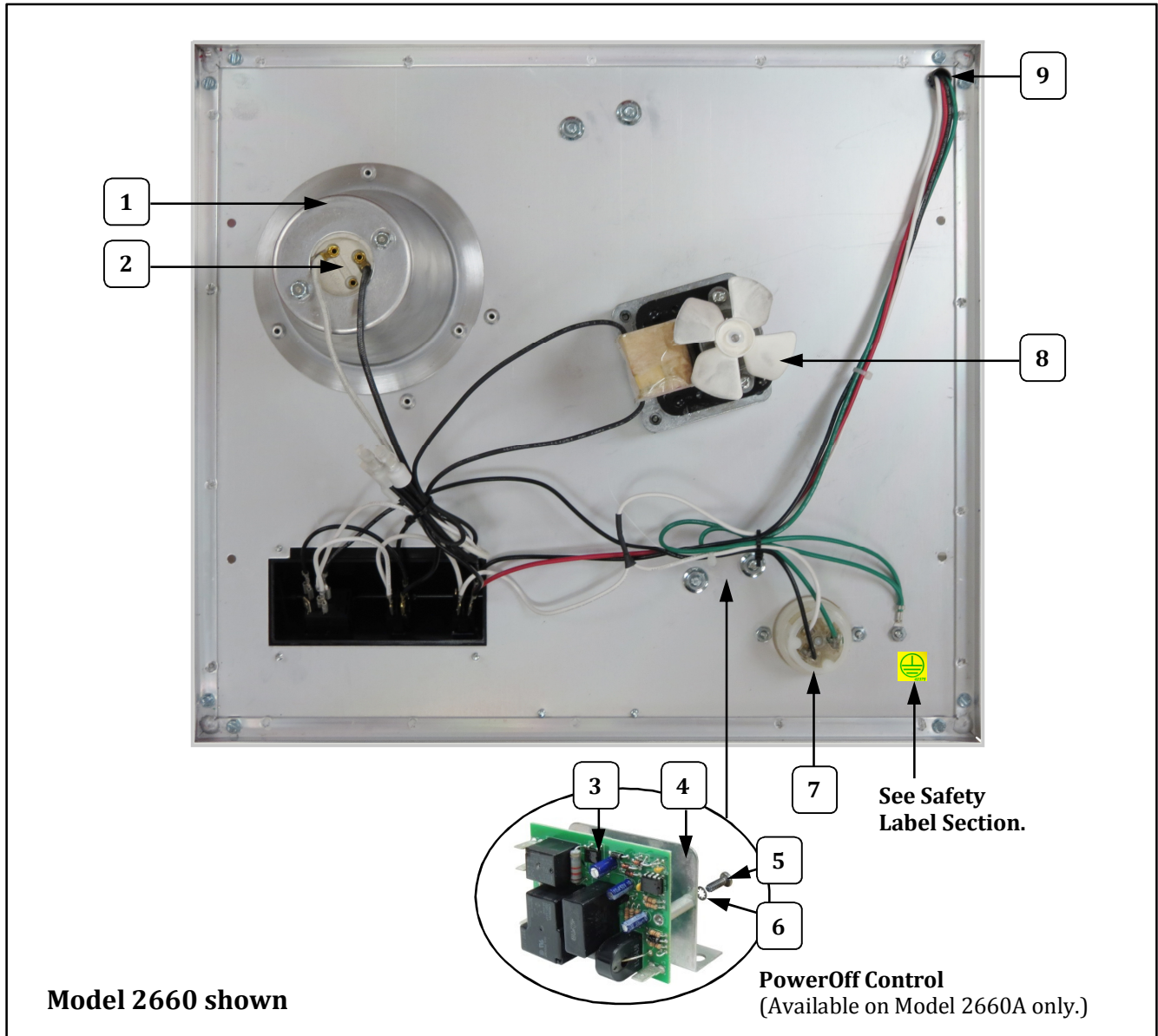

Item	Parts Description	Part Number			
		1871	2660	2660A	2660ST
1	LIGHT SHIELD CONICAL	49480	49480	49480	49480
2	LAMP HOLDER	47047	47047	47047	47047
3	AUTO KETTLE POWEROFF CNTRL PCB			55402	
4	BRACKET, KETTLE POWEROFF CNTRL			55427	
5	6-32 X 3/8 PHIL PAN M/S			39000	
6	#6 INTERNAL TOOTH L/W 410SS			39001	
7	15 AMP TWIST LOCK KETTLE RECPT	49330	49330	49330	49330
8	120 VOLT KETTLE DRIVE MOTOR	47038	47038	47038	47038
9	.500 IN BUSHING, SNAP	47236	47236	47236	47236



# Safety Labels

**1** → **MAXIMUM LAMP SIZE**  
75 WATT  
PUISSANCE MAXIMALE DE LA LAMPE  
MAXIMALE LAMPENLEISTUNG  
CAPACIDAD MAXIMA DE LA LAMPARA 41452

**2** → **UNPLUG THIS UNIT BEFORE CLEANING**  
DEBRANCHER CET APPAREIL AVANT NETTOYAGE  
ZIEHN SIE DEN STECKER AUS DER STECKDOSE,  
BEVOR SIE DIE MASCHINE REINIGEN  
DESCONECTE ESTA UNIDAD ANTES DE LIMPIARLA 76097

**3** → **FOR PARTS OR SERVICE CALL**  
GOLD MEDAL PRODUCTS CO.  
SERVICE DEPARTMENT  
1-800-543-0862 87935

**4** → **UNIVERSAL POPPER DECAL**  
41019

**5** → **MAIN GROUND LABEL**  
42375

**6** → **WARNING! CONTACT WITH THIS SURFACE WHILE THE APPLIANCE IS OPERATING MAY CAUSE BURNS**  
AVERTISSEMENT! CONTACT AVEC CETTE SURFACE PENDANT LE FONCTIONNEMENT DE L'APPAREIL POURRAIT CAUSER DES BRULURES 87087

**7** → **powerOff CONTROL**  
PATENT PENDING  
WHEN THE HEAT SWITCH LIGHT IS BLINKING, TURN THE HEAT SWITCH OFF-ON TO RESTART THE KETTLE HEAT

**Unit Labels**

**8** → **CONDUIT WARNING LABEL**  
82840

**10** → **POWER CORD TAG**  
76135

**Kettle Lead In Label**

**9** → **WARNING LABEL CORD**  
68720

**10** → **POWER CORD TAG**  
76135

**Power Cord Labels**

Item	Part Description	Part Number	
		1871 2660, 2660ST	2660A
1	WARNING, MAX LAMP 75W	41452	41452
2	LABEL UNPLUG TO CLEAN	76097	76097
3	SERVICE LABEL	87935	87935
4	UNIVERSAL POPPER DECAL	41019	41019
5	MAIN GROUND LABEL	42375	42375
6	WARNING, SURFACE CONTACT	87087	87087
7	LABEL POWEROFF CNTRL		55436
8	CONDUIT WARNING LABEL	82840	82840
9	WARNING LABEL CORD	68720	68720
10	POWER CORD TAG	76135	76135



## Accessories

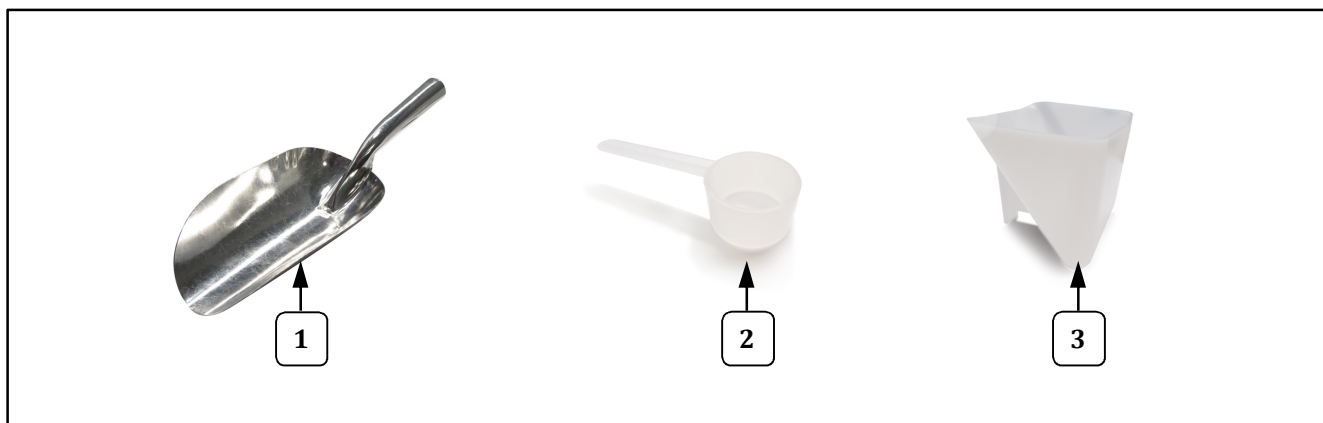

Item	Part Description	Part Number
		All Models
1	STAMPED ALUMINUM SCOOP	2071
2	6.5 CC MEASURE	<a href="#">47678</a>
3	6 OZ MEASURE	<a href="#">49049</a>



# Wiring Diagram

## Model No. 1871, 2660, 2660ST

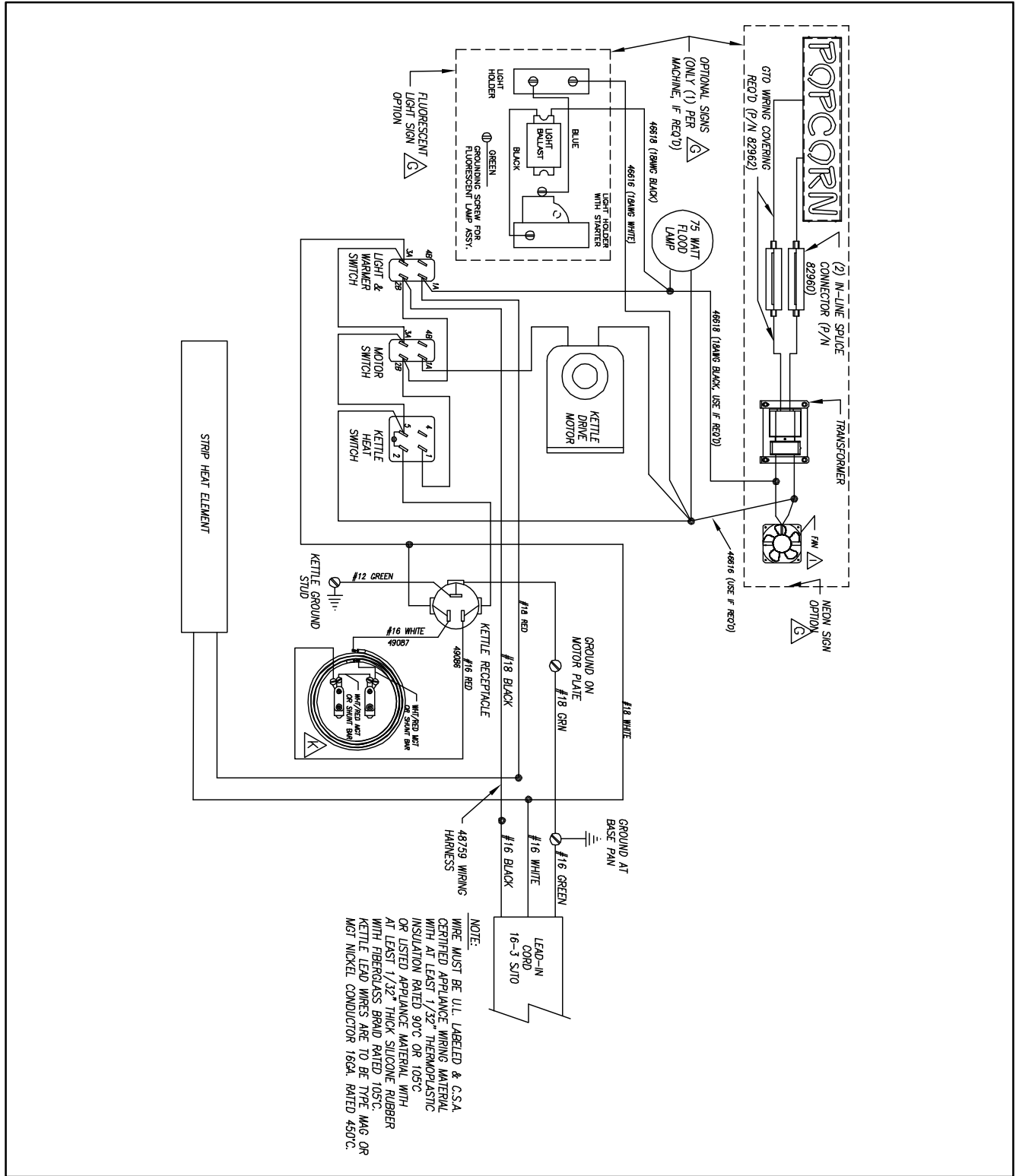



Model No. 2660A

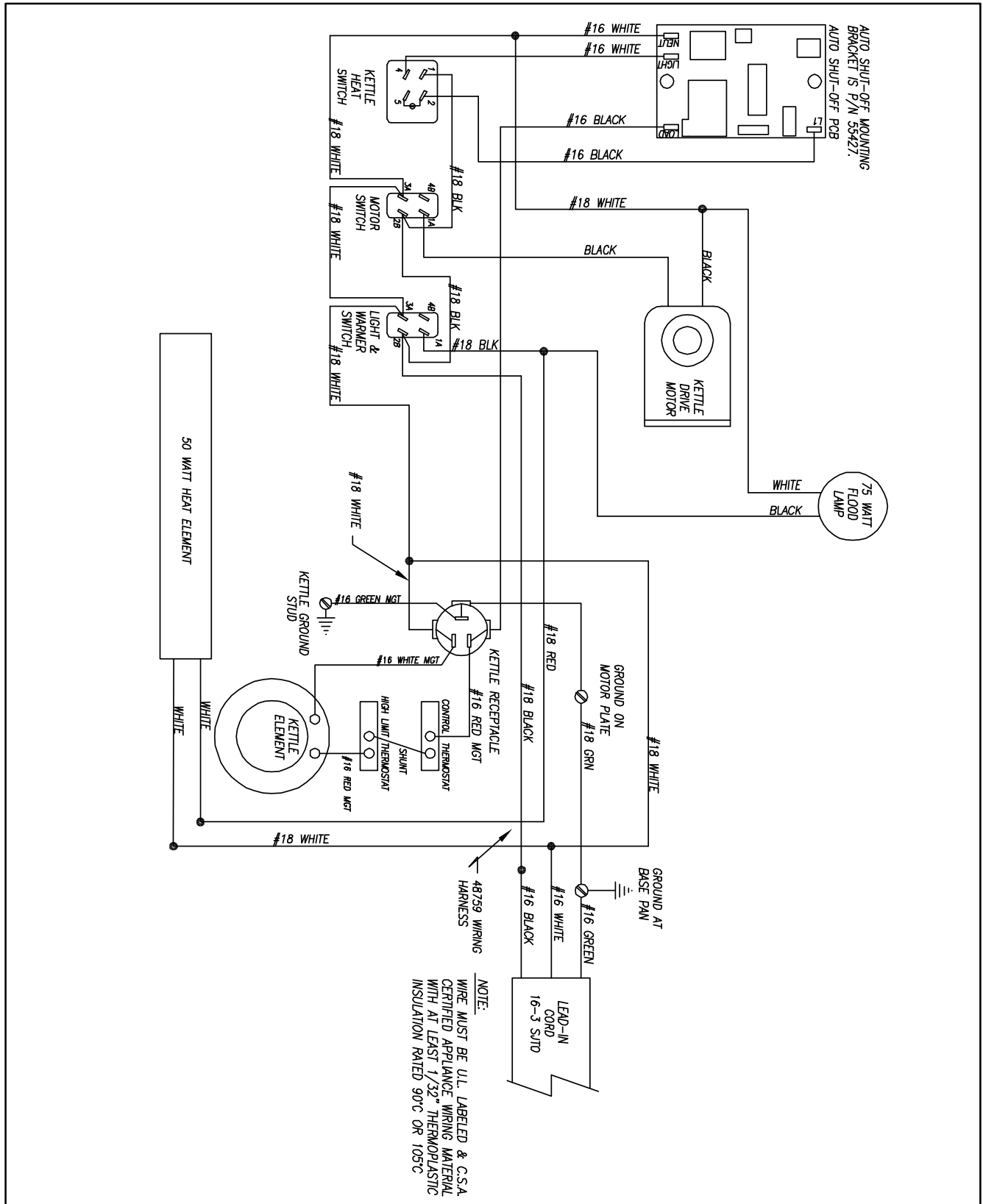



## WARRANTY

Gold Medal Products Co. warrants to the original purchaser each item of its manufacture to be free of defects in workmanship and material under normal use and service. Gold Medal Products Co.'s obligation under this warranty is limited solely to repairing or replacing parts, f.o.b. Cincinnati, Ohio, which in its judgment are defective in workmanship or material and which are returned, freight prepaid, to its Cincinnati, Ohio factory or other designated point. Except for "Perishable Parts" on specific machines, the above warranty applies for a period of two (2) years from the date of original sale to the original purchaser of equipment when recommended operating instructions and maintenance procedures have been followed. These are packed with the machine. Parts warranty is two (2) years, labor is six (6) months.

THIS WARRANTY IS IN LIEU OF ALL OTHER WARRANTIES EXPRESSED OR IMPLIED, AND OF ALL OTHER OBLIGATIONS OR LIABILITIES ON OUR PART, INCLUDING THE IMPLIED WARRANTY OF MERCHANTABILITY. THERE ARE NO WARRANTIES WHICH EXTEND BEYOND THE DESCRIPTION ON THE FACE HEREOF. In no event shall Gold Medal Products Co. be liable for special, incidental or consequential damages. No claim under this warranty will be honored if the equipment covered has been misused, neglected, damaged in transit, or has been tampered with or changed in any way. No claim under this warranty shall be honored in the event that components in the unit at the time of the claim were not supplied or approved by Gold Medal Products Co. This warranty is effective only when electrical items have been properly attached to city utility lines only at proper voltages. This warranty is not transferable without the written consent of Gold Medal Products Co.

The term "Original Purchaser" as used in this warranty shall be deemed to mean that person, firm, association, or corporation who was billed by the GOLD MEDAL PRODUCTS CO., or their authorized distributor for the equipment.

THIS WARRANTY HAS NO EFFECT AND IS VOID UNLESS THE ORIGINAL PURCHASER FIRST CALLS GOLD MEDAL PRODUCTS CO. AT 1-800-543-0862 TO DISCUSS WITH OUR SERVICE REPRESENTATIVE THE EQUIPMENT PROBLEM, AND, IF NECESSARY, FOR INSTRUCTIONS CONCERNING THE REPAIR OR REPLACEMENT OF PARTS.

*NOTE: This equipment is manufactured and sold for commercial use only.*



**GOLD MEDAL<sup>®</sup> PRODUCTS CO.**

10700 Medallion Drive, Cincinnati, Ohio 45241-4807 USA

[gmpopcorn.com](http://gmpopcorn.com)

Phone: (800) 543-0862      Fax: (800) 542-1496  
(513) 769-7676              (513) 769-8500